

General Description

The MAX30101 evaluation kit (EV kit) provides a proven design to evaluate the MAX30101 integrated pulse-oximetry and heart-rate monitor integrated circuit (IC). The EV kit consist of two boards. USBOSMB is the mother board and MAX30101DBEVKIT is the daughter board that includes the MAX30101 and an accelerometer. The EV kit is powered using the USB supply to generate +1.8V for the sensor and +4.5V for the internal LEDs of the MAX30101, and +3.3V for the accelerometer.

The EV kit comes with a MAX30101EFD+ installed in a 14-pin OESIP package.

Features

- Real-Time Monitoring
- Flexible PCB Design
- USB-Powered
- On-Board Accelerometer
- Proven PCB Layout
- Fully Assembled and Tested
- Windows® 7-, and Windows 8/8.1-Compatible Software

[Ordering Information](#) appears at end of data sheet.

Windows is a registered trademark and registered service mark of Microsoft Corporation.

Quick Start

Required Equipment

- MAX30101 accelerometer EV kit (MAX30101DBEVKIT#, USBOSMB#, 10-pin FFC cable, and micro-USB cable included)
- Windows PC

Note: Text in **bold** refers to items directly from the EV kit software. Text in **bold and underlined** refers to items from the Windows operating system.

Procedure

The EV kit is fully assembled and tested. Follow the steps below to verify board operation:

- 1) Visit www.maximintegrated.com/evkit-software to download the most recent version of the EV kit software, *MAX30101EVKitSetupVx.x.ZIP*. Save the EV kit software to a temporary folder and uncompress the ZIP file.
- 2) Open up *MAX30101EVKitSetupVx.x.exe* and follow the instructions from the pop-up windows.
- 3) Insert one end of the ribbon cable to the J3 connector of the USBOSMB and the other end of the ribbon cable to the J1 connector of the MAX30101DBEV-KIT. Make sure that both connectors and blue ends of the ribbon cable is facing the user.
- 4) Connect the USB cable from the PC to the EV kit board. Windows will automatically install all drivers.
- 5) Open the *MAX30101EVKit.exe* and verify that the EV kit is connected by observing the status bar at the lower left corner of the GUI. See [Figure 1](#).
- 6) Press the **Start Monitor** button.
- 7) Place your finger in front of the MAX30101 (U4) of the EV kit and observe the **Measurement** graphs. See [Figure 2](#). Example algorithm 1 and 2 are shown in separate windows ([Figure 3](#) and [Figure 4](#)).

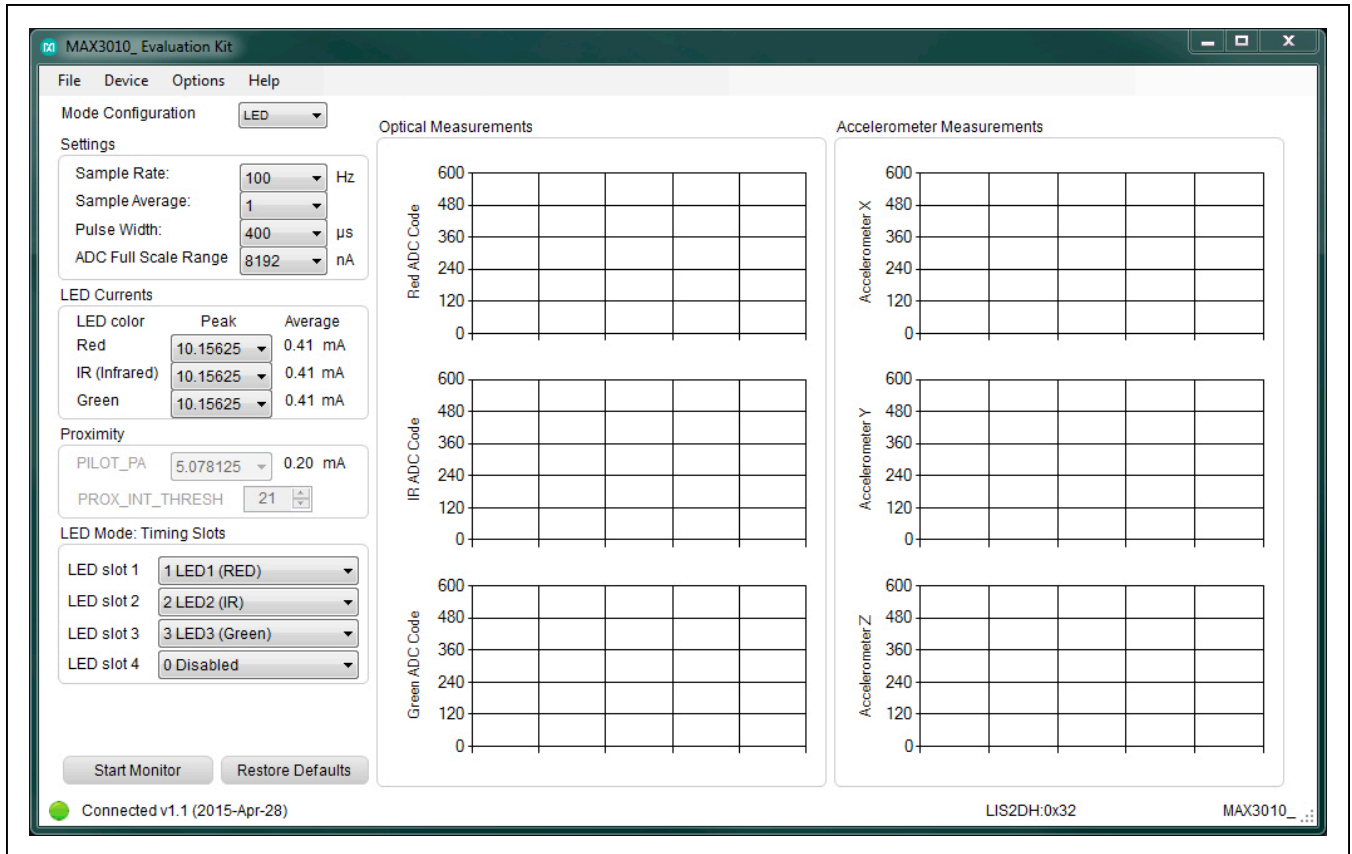

Figure 1. MAX30101 EV Kit Main Window

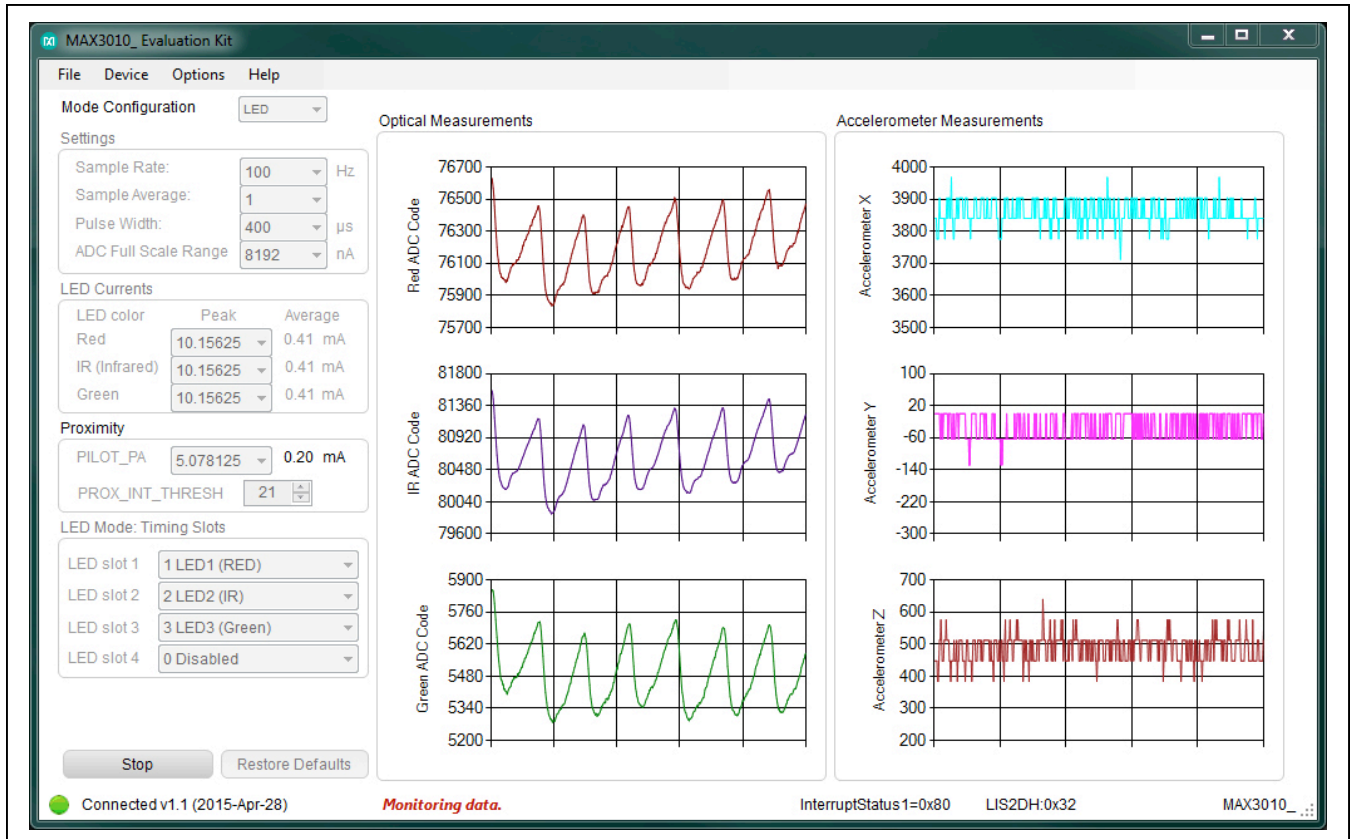

Figure 2. MAX30101 EV Kit Main Window (Sampling Data)

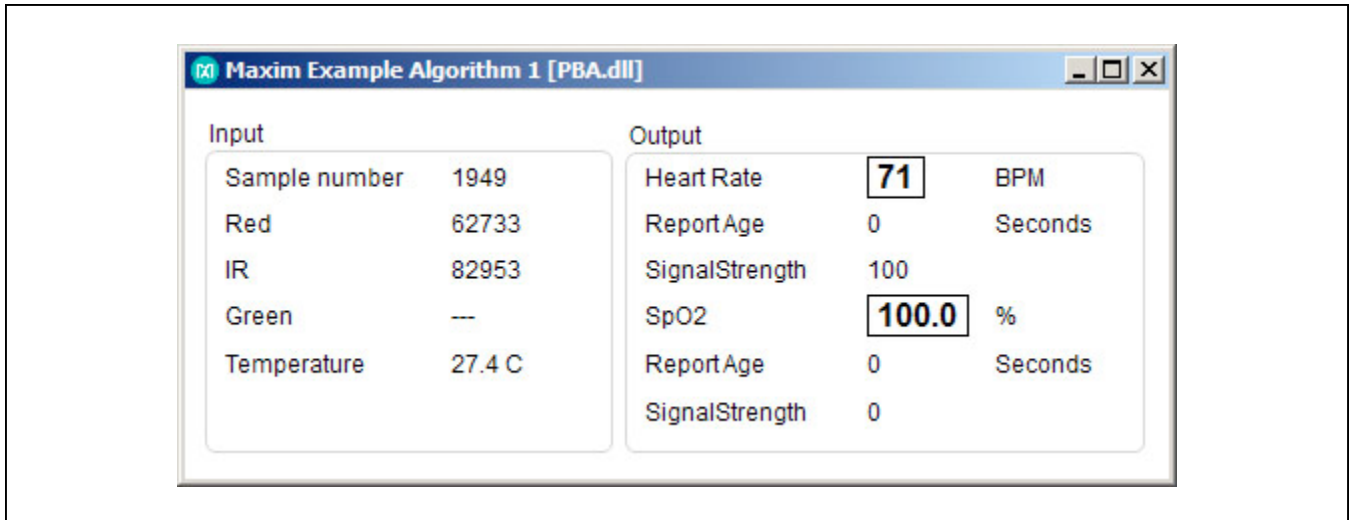

Figure 3. Maxim Example Algorithm 1 Window

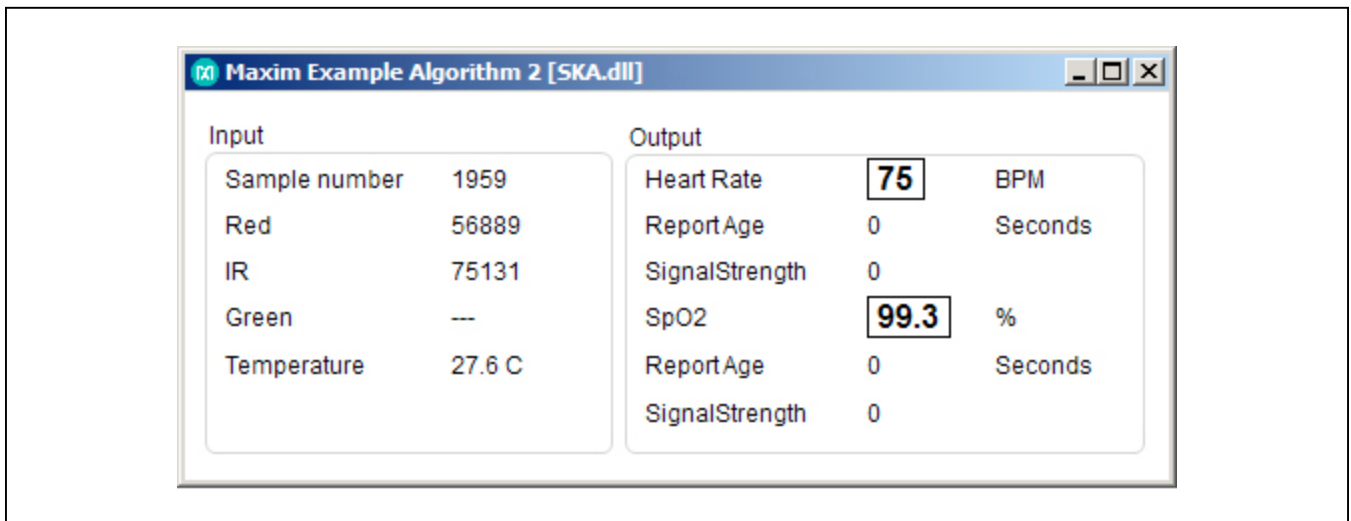

Figure 4. Maxim Example Algorithm 2 Window

Detailed Description of Software

The main window of the MAX30101 EV kit software displays the mode configuration, settings, LED currents, proximity, timing slots of the LED mode, ADC code measurements, and example algorithms.

Mode Configuration

The **Mode Configuration** drop-down list allows for three options: HR, SPO2, and LED. When HR is selected, only

red ADC codes are plotted. When SPO2 is selected, only red and IR codes are plotted. When LED is selected, red, IR, and/or green ADC codes are plotted. **Figure 5** shows the device configured to LED mode and using all three LEDs: red, IR, and green. Within LED mode, the **LED Mode Timing Slots** groupbox selections allow the user to enable the desired LEDs at each LED slot.

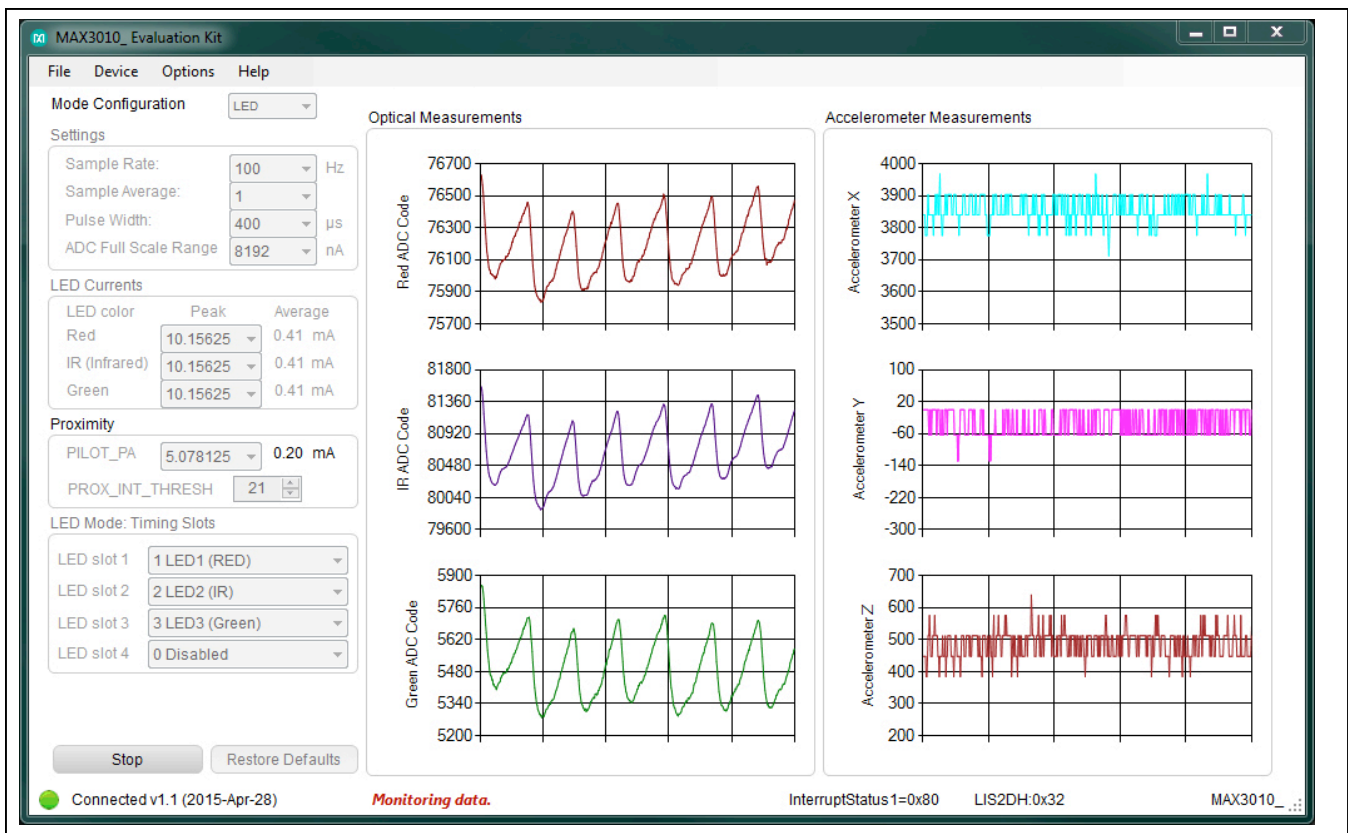

Figure 5. MAX30101 EV Kit Main Window (LED Mode with Green LED)

Settings

The **Settings** groupbox consist of controls to the sample rate and average, pulse width, and ADC full-scale range.

The **Sample Rate** drop-down list is adjustable from 50Hz to 400Hz.

The **Sample Average** drop-down list is adjustable from 1 to 32.

The **Pulse Width** dropdown list is adjustable from 50µs to 400µs.

The **ADC Full Scale Range** dropdown list is adjustable from 2048nA to 16384nA.

LED Currents

Within the **LED Currents** groupbox, the peak currents are adjustable from **0** to **50mA** for each LED. The average current based on the **Pulse Width** and **Sample Rate** is recalculated with each change in peak current.

Proximity

Under Proximity, **PILOT_PA** is adjustable from **0** to **50mA**.

Accelerometer

The accelerometer provides three degrees of freedom (3DOF). Moving the MAX30101DBEVKIT board will trigger changes in ADC data of the X, Y, and/or Z graphs.

Algorithms

[Figure 3](#) and [Figure 4](#) are example algorithms to calculate heart rate and SpO₂. They are calculated using the raw ADC data from the LEDs.

The two algorithms included with the EV kit are PBA and SKA. They are provided to demonstrate the capability of the product and are not intended for mass production. Here are some significant differences between the two.

PBA looks for zero crossing using slow threshold. The algorithm completes its cycle each sampling point. SKA waits for 3s and then looks for peak detection. The algorithm is processed every 1s, but it requires a more complex math operation. The user needs to present 3s FIFO data to algorithm. Heart rate is from average of 3s of data.

Each of these algorithms has its own advantage. For example, PBA requires much less data space and code space compared to SKA.

ALGORITHM	DELAY	MEMORY	DATA SPACE
PBA	None	5772	870
SKA	3s	31160	52723

Data Logging

From the menu bar, select **File | Log** and ADC data can be logged to a .csv file with the option of collecting data for a specific time using the **File | Timed Data Collection** selection from **5** to **60 seconds**. Once the desired configuration is set, press the **Start Monitor** button to capture data. The header for each data set includes the settings for sample rate, LED current, pulse width, and the mode. If the file name is not changed, subsequent data collection will append to the existing file and will include a new header.

Options

From the menu bar, **Options** allows the user to adjust the plot length and the x-axis, hide unused channels, show/hide the algorithm windows, and access registers from a bit level.

Detailed Description of Hardware

The MAX30101 EV kit provides a proven design to evaluate the MAX30101 integrated pulse-oximetry, heart-rate monitor module. The EV kit is powered through the +5V from the USB port to generate the regulated +1.8V to V_{DD} supply and +4.5V to the +VLED supply of the MAX30101. Use [Table 1](#) to change the R10 resistor to obtain the desired +VLED supply. The IC U1 of the EV kit is the on-board microcontroller that communicates with the MAX30101 through GPIO for the interrupt signal and I²C interface.

There is also a 3.3V supply on the EV board and is intended for the on-board MCU.

Table 1. Resistor Selection for +VLED Supply

+VLED	R10 (kΩ)
2.5V	14.3
3.3V	23.2
4.0V	31.6
4.5V	36.5*

*Default

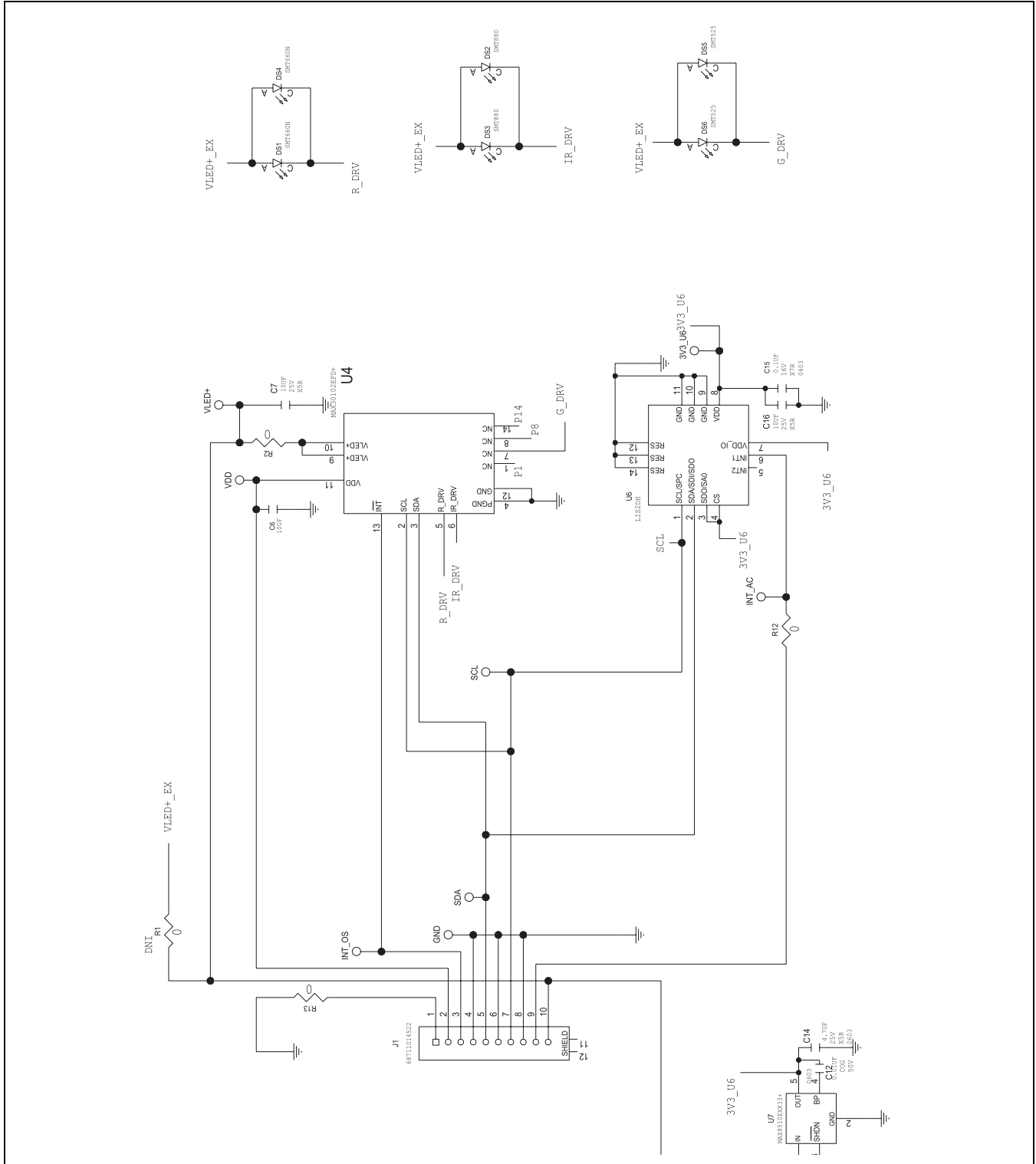

Figure 6. MAX30101 Daughter Board Schematic

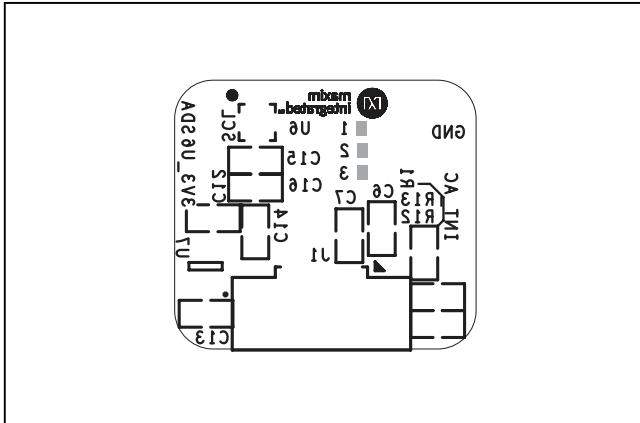

Figure 7. MAX30101 Daughter Board Component Placement Guide—Component Side

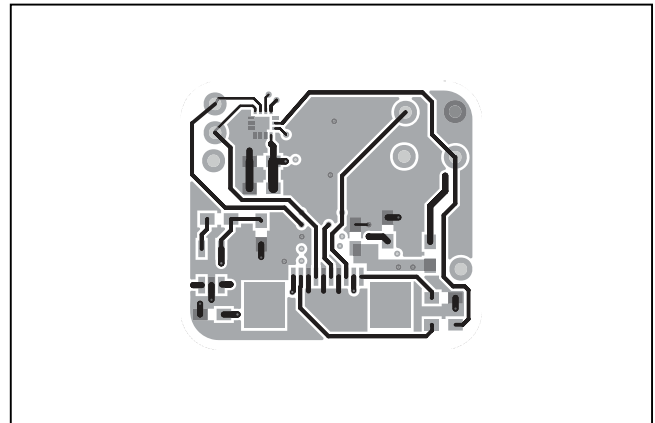

Figure 8. MAX30101 Daughter Board PCB Layout—Layer 2

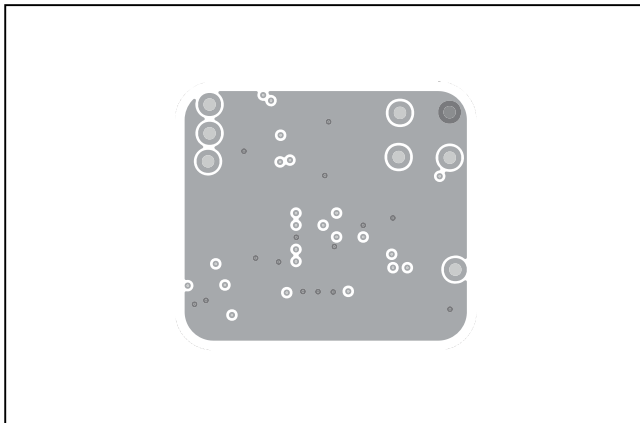

Figure 9. MAX30101 Daughter Board PCB Layout—Layer 3

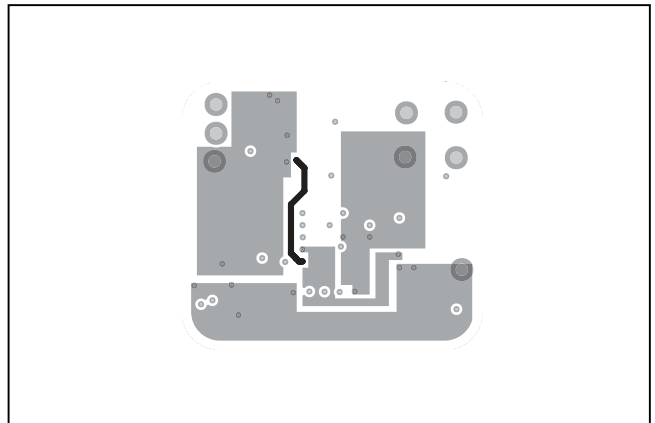

Figure 10. MAX30101 Daughter Board PCB Layout—Component Side

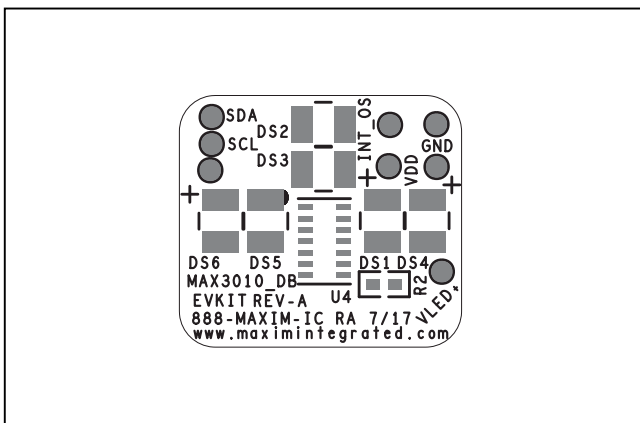

Figure 11. MAX30101 Daughter Board PCB Layout—Solder Side

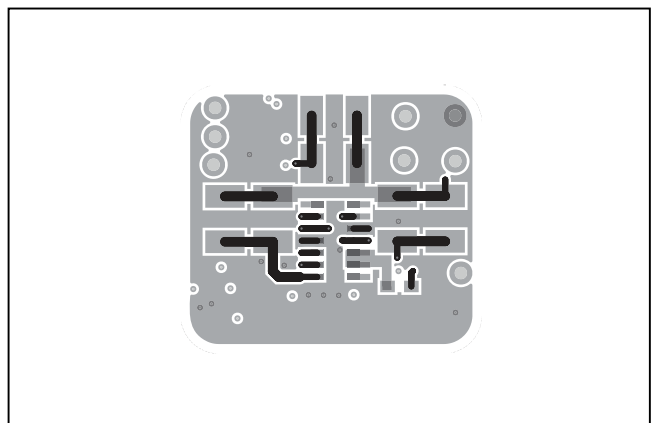

Figure 12. MAX30101 Daughter Board Component Placement Guide—Solder Side

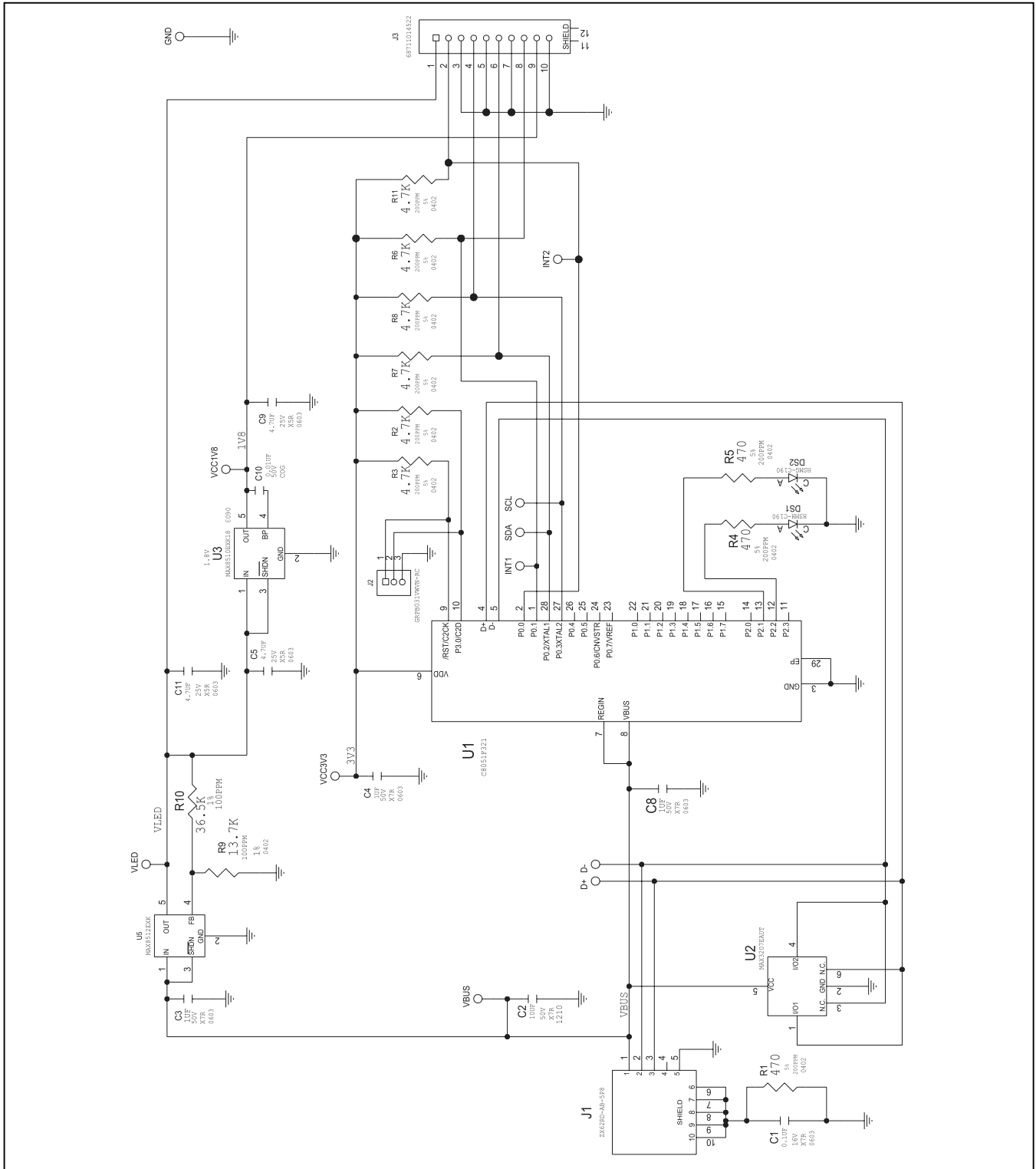

Figure 13. USBOSMB Mother Board Schematic

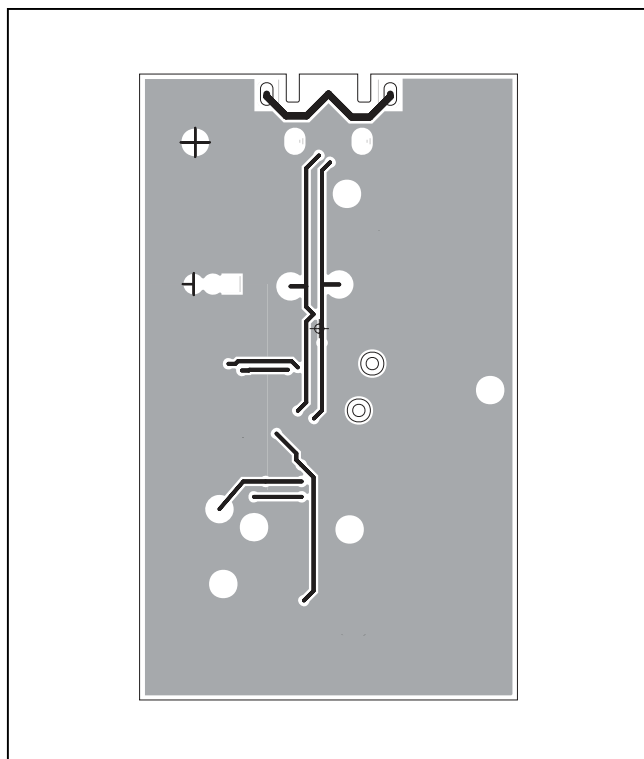

Figure 16. USBOSMB Mother Board PCB Layout—Solder Side

Component Lists

MAX30101 Accelerometer EV Kit

PART	QTY	DESCRIPTION
MAX30101DBEVKIT#	1	MAX30101 Daughter Board
USBOSMB#	1	Serial Interface Mother Board

Component List

See the following link for component information:

- [MAX30101 DB EV BOM](#)
- [MAX30101 USBOSMB EV BOM](#)

Ordering Information

PART	TYPE	LED
MAX30101ACCEVKIT#	EV Kit	IR, RED

#Denotes RoHS compliant.

Revision History

REVISION NUMBER	REVISION DATE	DESCRIPTION	PAGES CHANGED
0	5/16	Initial Release	—

For pricing, delivery, and ordering information, please contact Maxim Direct at 1-888-629-4642, or visit Maxim Integrated's website at www.maximintegrated.com.

Maxim Integrated cannot assume responsibility for use of any circuitry other than circuitry entirely embodied in a Maxim Integrated product. No circuit patent licenses are implied. Maxim Integrated reserves the right to change the circuitry and specifications without notice at any time.

TITLE: Bill of Materials
 DATE: 07/17/2015, Rev 0
 DESIGN: max30101_db_evkit_a

ITEM	QTY	REF DES	MFG PART #	MANUFACTURER	VALUE	DESCRIPTION
	1	1 C6	C1608X5R1A106K	TDK	10UF	CAPACITOR; SMT (0603); CERAMIC CHIP; 10UF; 10V; TOL=10%; MODEL=; TG=-55
	2	2 C7, C16	C1608X5R1E106M080AC; CL10A106MA8NRNC	TDK/SAMSUNG ELECTRONICS	10UF	CAPACITOR; SMT (0603); CERAMIC CHIP; 10UF; 25V; TOL=20%; TG=-55 DEGC TO
	3	1 C12	C1608C0G1H103J; CGA3E2C0G1H103J080AD	TDK	0.01UF	CAPACITOR; SMT (0603); CERAMIC CHIP; 0.01UF; 50V; TOL=5%; MODEL=C1608
	4	1 C13	UMK107AB7105KA	TAIYO YUDEN	1UF	CAPACITOR; SMT (0603); CERAMIC CHIP; 1UF; 50V; TOL=10%; TG=-55 DEGC TO
	5	1 C14	C1608X5R1E475K080AC	TDK	4.7UF	CAPACITOR; SMT (0603); CERAMIC CHIP; 4.7UF; 25V; TOL=10%; MODEL=C
	6	1 C15	C0603C104K4RACAUTO	KEMET	0.1UF	CAPACITOR; SMT (0603); CERAMIC CHIP; 0.1UF; 16V; TOL=10%; TG=-55 DEGC TO
	7	0 DS1, DS4,	DSMT660N	EPITEX	SMT660N	DIODE; LED; HIGH PERFORMANCE TOP LED; RED; SMT; VF=2V; IF=0.02A
	8	0 DS2, DS5,	SMT880	EPITEX	SMT880	DIODE; LED; HIGH PERFORMANCE TOP IR LED; INFRARED; SMT; VF=1.45V;
	9	0 DS3, DS6,	SMT525	EPITEX	SMT525	DIODE; LED; HIGH PERFORMANCE TOP LED; GREEN; SMT; VF=3.2V; IF=0.02A
	10	1 J1	68711014522	WURTH ELECTRONICS INC.	68711014522	CONNECTOR; FEMALE; SMT; 0.5MM ZIF HORIZONTAL BOTTOM CONTACT WR-
	11	0 R1	RC0805JR-070RL	YAGEO PHYCOMP	0	RESISTOR; 0805; 0 OHM; 5%; JUMPER; 0.125W; THICK FILM
	12	3 R2, R12, R1	RCRW06030000Z5; MCR03EZPJ000; ERJ-3GEY0R00	VISHAY DALE/ROHM/PANASONIC	0	RESISTOR; 0603; 0 OHM; 0%; JUMPER; 0.10W; THICK FILM
	13	1 U4	MAX30102EFD+	MAXIM	MAX30102EFD+	IC; SNSR; PULSE OXIMETER; HEART RATE AND UV SENSOR MODULE FOR MOBILE
	14	1 U6	LIS2DH	ST MICROELECTRONICS	LIS2DH	IC; MEMS; MEMS DIGITAL OUTPUT MOTION SENSOR; ULTRA LOW-POWER HIGH
	15	1 U7	MAX8510EXK33+	MAXIM	MAX8510EXK33+	IC; VREG; ULTRA-LOW-NOISE; HIGH PSRR; LOW-DROPOUT; 0.12A LINEAR
	16	1	EPCB	EPCB	MAXIM	PCB
TOTAL		25				

PACKOUT (These are DO NOT INSTALL parts and will be shipped with PCB)

ITEM	QTY	REF DES	MFG PART #	MANUFACTURER	VALUE	DESCRIPTION
	1	1 PACKOUT	88-00713-LRG	N/A	?	BOX;+;LARGE BROWN 15 1/8" X 8 3/4" X 3"
	2	1 PACKOUT	87-02162-00	N/A	?	ESD BAG;+;BAG;STATIC SHIELD ZIP 4inX6in;W/ESD LOGO - PACKOUT
	3	3 PACKOUT	85-MAXKIT-PNK	N/A	?	PINK FOAM;FOAM;ANTI-STATIC PE 12inX12inX5MM - PACKOUT
	4	3 PACKOUT	EVINSERT	N/A	?	WEB INSTRUCTIONS FOR MAXIM DATA SHEET
	5	3 PACKOUT	85-84003-006	N/A	?	LABEL(EV KIT BOX) - PACKOUT
	6	1 PACKOUT	88-00712-MDM	N/A	?	BOX;+;MEDIUM BROWN 9 3/8" X 7 1/4" X 2 1/2"
	7	1 PACKOUT	87-02159-000	N/A	?	ESD BAG;+;BAG; STATIC SHIELD 5"X8";W/ESD LOGO
	8	1 PACKOUT	88-00711-SML	N/A	?	BOX;SMALL BROWN 9 3/16"X7"X1 1/4" - PACKOUT
	9	1 PACKOUT	87-02163-000	N/A	?	ESD BAG;+;BAG; STATIC SHIELD ZIP 8"X10"; W/ ESD LOGO
TOTAL		15				

ITEM	QTY	REF DES	MFG PART MANUFACTURER	VALUE	DESCRIPTION	STATUS
1	1	C1	C0603C104 KEMET	0.1UF	CAPACITOR; SMT (0603); CERAMIC CHIP; 0.1UF; 16V; TOL=10%; TG=-55 DEGC TO +125 DEGC; TC=X7R AUTO	EVKIT-NOT FOR TEST
2	1	C2	GRM32ER7 MURATA; SAMSUNG ELECTRONICS	10UF	CAPACITOR; SMT (1210); CERAMIC CHIP; 10UF; 50V; TOL=10%; TG=-55 DEGC TO +125 DEGC; TC=X7R	ACTIVE
3	3	C3, C4, C8	UMK107AETAIYO YUDEN	1UF	CAPACITOR; SMT (0603); CERAMIC CHIP; 1UF; 50V; TOL=10%; TG=-55 DEGC TO +125 DEGC; TC=X7R	ACTIVE
4	3	C5, C9, C11	C1608X5R1TDK	4.7UF	CAPACITOR; SMT (0603); CERAMIC CHIP; 4.7UF; 25V; TOL=10%; MODEL=C SERIES; TG=-55 DEGC TO +85 DEGC; TC=X5R	ACTIVE
5	1	C10	C1608C0G;TDK; MURATA	0.01UF	CAPACITOR; SMT (0603); CERAMIC CHIP; 0.01UF; 50V; TOL=5%; TG=-55 DEGC to +125 DEGC; TC=C0G	ACTIVE
6	1	DS1	HSMH-C19 AVAGO TECHNOLOGIES	HSMH-C190	DIODE; LED; SURFACE MOUNT CHIP LED; RED; SMT (0603); PIV=1.8V; IF=0.02A	EVKIT-NOT FOR TEST
7	1	DS2	HSMG-C19 AVAGO TECHNOLOGIES	HSMG-C190	DIODE; LED; SURFACE MOUNT CHIP LED; GREEN; SMT (0603); PIV=2.2V; IF=0.02A	EVKIT-NOT FOR TEST
8	1	J1	ZX62RD-AB HIROSE ELECTRIC CO LTD.	ZX62RD-AB-5P8	CONNECTOR; MALE; SMT; MICRO-USB CONNECTOR MEETING REQUIREMENTS OF USB 2.0 STANDARD; RIGHT ANGLE; 5PINS	ACTIVE
9	1	J2	GRP8031V SULLINS ELECTRONICS CORP.	GRP8031VWVN-RC	CONNECTOR; MALE; THROUGH HOLE; 0.050" SINGLE ROW MALE HEADER CONNECTOR; STRAIGHT; 3PINS; -40 DEGC TO +105 DEGC	EVKIT-NOT FOR TEST
10	1	J3	6.87E+10 WURTH ELECTRONICS INC.	68711014522	CONNECTOR; FEMALE; SMT; 0.5MM ZIF HORIZONTAL BOTTOM CONTACT WR-FPC; RIGHT ANGLE; 10PINS	EVKIT-NOT FOR TEST
11	3	R1, R4, R5	ERJ-2GEJ47 PANASONIC	470	RESISTOR; 0402; 470 OHM; 5%; 200PPM; 0.10W; THICK FILM	EVKIT-NOT FOR TEST
12	6	R2, R3, R6	ERJ-2GEJ47 PANASONIC	4.7K	RESISTOR; 0402; 4.7K OHM; 5%; 200PPM; 0.10W; THICK FILM	EVKIT-NOT FOR TEST
13	1	R9	CRCW0402 VISHAY DALE	13.7K	RESISTOR; 0402; 13.7K OHM; 1%; 100PPM; 0.063W; THICK FILM	ACTIVE
14	1	R10	CRCW0402 PANASONIC	36.5K	RESISTOR; 0402; 36.5K OHM; 1%; 100PPM; 0.063W; THICK FILM	EVKIT-NOT FOR TEST
15	1	U1	C8051F321 SILICON LABORATORIES	C8051F321	IC; CTRL; FULL SPEED USB, 16K ISP FLASH MCU FAMILY; QFN28-EP	EVKIT-NOT FOR TEST
16	1	U2	MAX3207E MAXIM	MAX3207EAUT	IC; PROT; DUAL, QUAD, AND HEX HIGH-SPEED DIFFERENTIAL ESD-PROTECTION IC; SOT23-6	ACTIVE
17	1	U3	MAX8510E MAXIM	MAX8510EXK18	IC; VREG; ULTRA-LOW-NOISE; HIGH PSRR; LOW-DROPOUT; 0.12A LINEAR REGULATOR; SC70-5	ACTIVE
18	1	U5	MAX8512E MAXIM	MAX8512EXK	IC, VREG, Ultra-Low-Noise, High PSRR, Adjustable Vout, SC70-5	ACTIVE
19	1	EPCB	MAX	MAXIM	PCB	PCB: MAX
TOTAL	30					
PACK_OUT						
1	1		6.88E+11 WURTH ELECTRONICS INC.		WR_FF0 0.50mm TYPE 1 CABLE	

Компания «Океан Электроники» предлагает заключение долгосрочных отношений при поставках импортных электронных компонентов на взаимовыгодных условиях!

Наши преимущества:

- Поставка оригинальных импортных электронных компонентов напрямую с производств Америки, Европы и Азии, а так же с крупнейших складов мира;
- Широкая линейка поставок активных и пассивных импортных электронных компонентов (более 30 млн. наименований);
- Поставка сложных, дефицитных, либо снятых с производства позиций;
- Оперативные сроки поставки под заказ (от 5 рабочих дней);
- Экспресс доставка в любую точку России;
- Помощь Конструкторского Отдела и консультации квалифицированных инженеров;
- Техническая поддержка проекта, помощь в подборе аналогов, поставка прототипов;
- Поставка электронных компонентов под контролем ВП;
- Система менеджмента качества сертифицирована по Международному стандарту ISO 9001;
- При необходимости вся продукция военного и аэрокосмического назначения проходит испытания и сертификацию в лаборатории (по согласованию с заказчиком);
- Поставка специализированных компонентов военного и аэрокосмического уровня качества (Xilinx, Altera, Analog Devices, Intersil, Interpoint, Microsemi, Actel, Aeroflex, Peregrine, VPT, Syfer, Eurofarad, Texas Instruments, MS Kennedy, Miteq, Cobham, E2V, MA-COM, Hittite, Mini-Circuits, General Dynamics и др.);

Компания «Океан Электроники» является официальным дистрибьютором и эксклюзивным представителем в России одного из крупнейших производителей разъемов военного и аэрокосмического назначения «JONHON», а так же официальным дистрибьютором и эксклюзивным представителем в России производителя высокотехнологичных и надежных решений для передачи СВЧ сигналов «FORSTAR».



JONHON

«JONHON» (основан в 1970 г.)

Разъемы специального, военного и аэрокосмического назначения:

(Применяются в военной, авиационной, аэрокосмической, морской, железнодорожной, горно- и нефтедобывающей отраслях промышленности)

«FORSTAR» (основан в 1998 г.)

ВЧ соединители, коаксиальные кабели,
кабельные сборки и микроволновые компоненты:

(Применяются в телекоммуникациях гражданского и специального назначения, в средствах связи, РЛС, а так же военной, авиационной и аэрокосмической отраслях промышленности).



Телефон: 8 (812) 309-75-97 (многоканальный)

Факс: 8 (812) 320-03-32

Электронная почта: ocean@oceanchips.ru

Web: <http://oceanchips.ru/>

Адрес: 198099, г. Санкт-Петербург, ул. Калинина, д. 2, корп. 4, лит. А