

# CAT93C46

## 1 kb Microwire Serial EEPROM

### Description

The CAT93C46 is a 1 kb Serial EEPROM memory device which is configured as either 64 registers of 16 bits (ORG pin at V<sub>CC</sub>) or 128 registers of 8 bits (ORG pin at GND). Each register can be written (or read) serially by using the DI (or DO) pin. The CAT93C46 features a self-timed internal write with auto-clear. On-chip Power-On Reset circuit protects the internal logic against powering up in the wrong state.

### Features

- High Speed Operation: 4 MHz (5 V), 2 MHz (1.8 V)
- 1.8 V (1.65 V\*) to 5.5 V Supply Voltage Range
- Selectable x8 or x16 Memory Organization
- Self-Timed Write Cycle with Auto-Clear
- Sequential Read (New Product)
- Software Write Protection
- Power-up Inadvertant Write Protection
- Low Power CMOS Technology
- 1,000,000 Program/Erase Cycles
- 100 Year Data Retention
- Industrial and Extended Temperature Ranges
- 8-pin PDIP, SOIC, TSSOP and 8-pad UDFN and TDFN Packages
- This Device is Pb-Free, Halogen Free/BFR Free and RoHS Compliant†

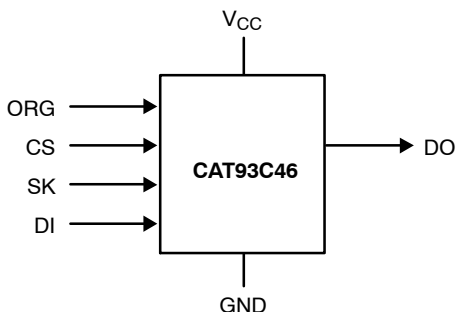

Figure 1. Functional Symbol

\*CAT93C46xx-xxL (T<sub>A</sub> = -20°C to +85°C)

†For additional information on our Pb-Free strategy and soldering details, please download the ON Semiconductor Soldering and Mounting Techniques Reference Manual, SOLDERRM/D.



ON Semiconductor®

<http://onsemi.com>

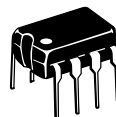

PDIP-8  
L SUFFIX  
CASE 646AA

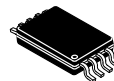

TSSOP-8  
Y SUFFIX  
CASE 948AL



SOIC-8  
V, W\*\* SUFFIX  
CASE 751BD



SOIC-8  
X SUFFIX  
CASE 751BE



UDFN-8  
HU4 SUFFIX  
CASE 517AZ



TDFN-8\*\*  
VP2 SUFFIX  
CASE 511AK

### PIN CONFIGURATIONS

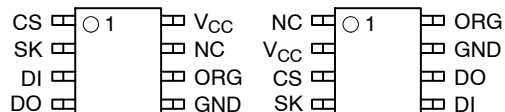

PDIP (L), SOIC (V, X),  
TSSOP (Y), UDFN (HU4),  
TDFN (VP2)\*\*  
(Top View)

SOIC (W)\*\*  
(Top View)

\*\* Not recommended for new designs.

### PIN FUNCTION

Pin Name	Function
CS	Chip Select
SK	Clock Input
DI	Serial Data Input
DO	Serial Data Output
V <sub>CC</sub>	Power Supply
GND	Ground
ORG	Memory Organization
NC	No Connection

Note: When the ORG pin is connected to V<sub>CC</sub>, the x16 organization is selected. When it is connected to ground, the x8 organization is selected. If the ORG pin is left unconnected, then an internal pullup device will select the x16 organization.

### ORDERING INFORMATION

See detailed ordering and shipping information in the package dimensions section on page 15 of this data sheet.

# CAT93C46

**Table 1. ABSOLUTE MAXIMUM RATINGS**

Parameter	Value	Units
Storage Temperature	-65 to +150	°C
Voltage on Any Pin with Respect to Ground (Note 1)	-0.5 to +6.5	V

Stresses exceeding Maximum Ratings may damage the device. Maximum Ratings are stress ratings only. Functional operation above the Recommended Operating Conditions is not implied. Extended exposure to stresses above the Recommended Operating Conditions may affect device reliability.

1. The DC input voltage on any pin should not be lower than -0.5 V or higher than  $V_{CC} + 0.5$  V. During transitions, the voltage on any pin may undershoot to no less than -1.5 V or overshoot to no more than  $V_{CC} + 1.5$  V, for periods of less than 20 ns.

**Table 2. RELIABILITY CHARACTERISTICS (Note 2)**

Symbol	Parameter	Min	Units
$N_{END}$ (Note 3)	Endurance	1,000,000	Program / Erase Cycles
$T_{DR}$	Data Retention	100	Years

2. These parameters are tested initially and after a design or process change that affects the parameter according to appropriate AEC-Q100 and JEDEC test methods.
3. Block Mode,  $V_{CC} = 5$  V, 25°C

**Table 3. D.C. OPERATING CHARACTERISTICS – MATURE PRODUCT (Not Recommended for New Designs)**

( $V_{CC} = +1.8$  V to +5.5 V,  $T_A = -40$ °C to +85°°C, unless otherwise specified.)

Symbol	Parameter	Test Conditions	Min	Max	Units
$I_{CC1}$	Power Supply Current (Write)	$f_{SK} = 1$ MHz $V_{CC} = 5.0$ V		1	mA
$I_{CC2}$	Power Supply Current (Read)	$f_{SK} = 1$ MHz $V_{CC} = 5.0$ V		500	μA
$I_{SB1}$	Power Supply Current (Standby) (x8 Mode)	$V_{IN} = GND$ or $V_{CC}$ , CS = GND ORG = GND		2	μA
$I_{SB2}$	Power Supply Current (Standby) (x16 Mode)	$V_{IN} = GND$ or $V_{CC}$ , CS = GND ORG = Float or $V_{CC}$		1	μA
$I_{LI}$	Input Leakage Current	$V_{IN} = GND$ to $V_{CC}$		1	μA
$I_{LO}$	Output Leakage Current	$V_{OUT} = GND$ to $V_{CC}$ , CS = GND		1	μA
$V_{IL1}$	Input Low Voltage	$4.5$ V $\leq V_{CC} < 5.5$ V	-0.1	0.8	V
$V_{IH1}$	Input High Voltage	$4.5$ V $\leq V_{CC} < 5.5$ V	2	$V_{CC} + 1$	V
$V_{IL2}$	Input Low Voltage	$1.8$ V $\leq V_{CC} < 4.5$ V	0	$V_{CC} \times 0.2$	V
$V_{IH2}$	Input High Voltage	$1.8$ V $\leq V_{CC} < 4.5$ V	$V_{CC} \times 0.7$	$V_{CC} + 1$	V
$V_{OL1}$	Output Low Voltage	$4.5$ V $\leq V_{CC} < 5.5$ V $I_{OL} = 2.1$ mA		0.4	V
$V_{OH1}$	Output High Voltage	$4.5$ V $\leq V_{CC} < 5.5$ V $I_{OH} = -400$ μA	2.4		V
$V_{OL2}$	Output Low Voltage	$1.8$ V $\leq V_{CC} < 4.5$ V $I_{OL} = 1$ mA		0.2	V
$V_{OH2}$	Output High Voltage	$1.8$ V $\leq V_{CC} < 4.5$ V $I_{OH} = -100$ μA	$V_{CC} - 0.2$		V

# CAT93C46

**Table 4. D.C. OPERATING CHARACTERISTICS – NEW PRODUCT (REV P)**

( $V_{CC} = +1.8\text{ V to }+5.5\text{ V}$ ,  $T_A = -40^\circ\text{C to }+125^\circ\text{C}$ ,  $V_{CC} = +1.65\text{ V to }+5.5\text{ V}$ ,  $T_A = -20^\circ\text{C to }+85^\circ\text{C}$  unless otherwise specified.)

Symbol	Parameter	Test Conditions	Min	Max	Units
$I_{CC1}$	Supply Current (Write)	Write, $V_{CC} = 5.0\text{ V}$		1	mA
$I_{CC2}$	Supply Current (Read)	Read, DO open, $f_{SK} = 2\text{ MHz}$ , $V_{CC} = 5.0\text{ V}$		500	$\mu\text{A}$
$I_{SB1}$	Standby Current (x8 Mode)	$V_{IN} = \text{GND or } V_{CC}$ $CS = \text{GND, ORG} = \text{GND}$	$T_A = -40^\circ\text{C to }+85^\circ\text{C}$	2	$\mu\text{A}$
			$T_A = -40^\circ\text{C to }+125^\circ\text{C}$	5	
$I_{SB2}$	Standby Current (x16 Mode)	$V_{IN} = \text{GND or } V_{CC}$ $CS = \text{GND, ORG} = \text{Float or } V_{CC}$	$T_A = -40^\circ\text{C to }+85^\circ\text{C}$	1	$\mu\text{A}$
			$T_A = -40^\circ\text{C to }+125^\circ\text{C}$	3	
$I_{LI}$	Input Leakage Current	$V_{IN} = \text{GND to } V_{CC}$	$T_A = -40^\circ\text{C to }+85^\circ\text{C}$	1	$\mu\text{A}$
			$T_A = -40^\circ\text{C to }+125^\circ\text{C}$	2	
$I_{LO}$	Output Leakage Current	$V_{OUT} = \text{GND to } V_{CC}$ $CS = \text{GND}$	$T_A = -40^\circ\text{C to }+85^\circ\text{C}$	1	$\mu\text{A}$
			$T_A = -40^\circ\text{C to }+125^\circ\text{C}$	2	
$V_{IL1}$	Input Low Voltage	$4.5\text{ V} \leq V_{CC} < 5.5\text{ V}$	-0.1	0.8	V
$V_{IH1}$	Input High Voltage	$4.5\text{ V} \leq V_{CC} < 5.5\text{ V}$	2	$V_{CC} + 1$	V
$V_{IL2}$	Input Low Voltage	$1.8\text{ V} \leq V_{CC} < 4.5\text{ V}$	0	$V_{CC} \times 0.2$	V
$V_{IH2}$	Input High Voltage	$1.8\text{ V} \leq V_{CC} < 4.5\text{ V}$	$V_{CC} \times 0.7$	$V_{CC} + 1$	V
$V_{OL1}$	Output Low Voltage	$4.5\text{ V} \leq V_{CC} < 5.5\text{ V}$ , $I_{OL} = 3\text{ mA}$		0.4	V
$V_{OH1}$	Output High Voltage	$4.5\text{ V} \leq V_{CC} < 5.5\text{ V}$ , $I_{OH} = -400\text{ }\mu\text{A}$	2.4		V
$V_{OL2}$	Output Low Voltage	$1.8\text{ V} \leq V_{CC} < 4.5\text{ V}$ , $I_{OL} = 1\text{ mA}$		0.2	V
$V_{OH2}$	Output High Voltage	$1.8\text{ V} \leq V_{CC} < 4.5\text{ V}$ , $I_{OH} = -100\text{ }\mu\text{A}$	$V_{CC} - 0.2$		V

**Table 5. PIN CAPACITANCE** ( $T_A = 25^\circ\text{C}$ ,  $f = 1\text{ MHz}$ ,  $V_{CC} = 5\text{ V}$ )

Symbol	Test	Conditions	Min	Typ	Max	Units
$C_{OUT}$ (Note 4)	Output Capacitance (DO)	$V_{OUT} = 0\text{ V}$			5	pF
$C_{IN}$ (Note 4)	Input Capacitance (CS, SK, DI, ORG)	$V_{IN} = 0\text{ V}$			5	pF

4. These parameters are tested initially and after a design or process change that affects the parameter according to appropriate AEC-Q100 and JEDEC test methods.

**Table 6. A.C. CHARACTERISTICS – MATURE PRODUCT (Not Recommended for New Designs)**

( $V_{CC} = +1.8\text{ V to }+5.5\text{ V}$ ,  $T_A = -40^\circ\text{C to }+85^\circ\text{C}$ , unless otherwise specified.) (Note 5)

Symbol	Parameter	Min Limit	Max Limit	Units
$t_{CSS}$	CS Setup Time	50		ns
$t_{CSH}$	CS Hold Time	0		ns
$t_{DIS}$	DI Setup Time	100		ns
$t_{DIH}$	DI Hold Time	100		ns
$t_{PD1}$	Output Delay to 1		0.25	$\mu\text{s}$
$t_{PD0}$	Output Delay to 0		0.25	$\mu\text{s}$
$t_{HZ}$ (Note 6)	Output Delay to High-Z		100	ns
$t_{EW}$	Program/Erase Pulse Width		5	ms
$t_{CSMIN}$	Minimum CS Low Time	0.25		$\mu\text{s}$
$t_{SKHI}$	Minimum SK High Time	0.25		$\mu\text{s}$
$t_{SKLOW}$	Minimum SK Low Time	0.25		$\mu\text{s}$
$t_{SV}$	Output Delay to Status Valid		0.25	$\mu\text{s}$
$SK_{MAX}$	Maximum Clock Frequency	DC	2000	kHz

5. Test conditions according to "AC Test Conditions" table.

6. These parameters are tested initially and after a design or process change that affects the parameter according to appropriate AEC-Q100 and JEDEC test methods.

# CAT93C46

**Table 7. A.C. CHARACTERISTICS – NEW PRODUCT (Rev P)**

( $V_{CC} = +1.8\text{ V to }+5.5\text{ V}$ ,  $T_A = -40^\circ\text{C to }+125^\circ\text{C}$ ,  $V_{CC} = +1.65\text{ V to }+5.5\text{ V}$ ,  $T_A = -20^\circ\text{C to }+85^\circ\text{C}$  unless otherwise specified.)

Symbol	Parameter	$V_{CC} = 1.8\text{ V} - 5.5\text{ V}$		$V_{CC} = 4.5\text{ V} - 5.5\text{ V}$		Units
		Min	Max	Min	Max	
$t_{CSS}$	CS Setup Time	50		50		ns
$t_{CSH}$	CS Hold Time	0		0		ns
$t_{DIS}$	DI Setup Time	100		50		ns
$t_{DIH}$	DI Hold Time	100		50		ns
$t_{PD1}$	Output Delay to 1		0.25		0.1	$\mu\text{s}$
$t_{PD0}$	Output Delay to 0		0.25		0.1	$\mu\text{s}$
$t_{HZ}$ (Note 7)	Output Delay to High-Z		100		100	ns
$t_{EW}$	Program/Erase Pulse Width		5		5	ms
$t_{CSMIN}$	Minimum CS Low Time	0.25		0.1		$\mu\text{s}$
$t_{SKHI}$	Minimum SK High Time	0.25		0.1		$\mu\text{s}$
$t_{SKLOW}$	Minimum SK Low Time	0.25		0.1		$\mu\text{s}$
$t_{SV}$	Output Delay to Status Valid		0.25		0.1	$\mu\text{s}$
$SK_{MAX}$	Maximum Clock Frequency	DC	2000	DC	4000	kHz

7. This parameter is tested initially and after a design or process change that affects the parameter.

**Table 8. POWER-UP TIMING** (Notes 8 and 9)

Symbol	Parameter	Max	Units
$t_{PUR}$	Power-up to Read Operation	1	ms
$t_{PUW}$	Power-up to Write Operation	1	ms

8. These parameters are tested initially and after a design or process change that affects the parameter according to appropriate AEC-Q100 and JEDEC test methods.

9.  $t_{PUR}$  and  $t_{PUW}$  are the delays required from the time  $V_{CC}$  is stable until the specified operation can be initiated.

**Table 9. A.C. TEST CONDITIONS**

Input Rise and Fall Times	$\leq 50\text{ ns}$	
Input Pulse Voltages	0.4 V to 2.4 V	$4.5\text{ V} \leq V_{CC} \leq 5.5\text{ V}$
Timing Reference Voltages	0.8 V, 2.0 V	$4.5\text{ V} \leq V_{CC} \leq 5.5\text{ V}$
Input Pulse Voltages	$0.2 V_{CC}$ to $0.7 V_{CC}$	$1.8\text{ V} \leq V_{CC} \leq 4.5\text{ V}$
Timing Reference Voltages	$0.5 V_{CC}$	$1.8\text{ V} \leq V_{CC} \leq 4.5\text{ V}$
Output Load	Current Source $I_{OLmax}/I_{OHmax}$ ; $C_L = 100\text{ pF}$	

**Device Operation**

The CAT93C46 is a 1024-bit nonvolatile memory intended for use with industry standard microprocessors. The CAT93C46 can be organized as either registers of 16 bits or 8 bits. When organized as X16, seven 9-bit instructions control the reading, writing and erase operations of the device. When organized as X8, seven 10-bit instructions control the reading, writing and erase operations of the device. The CAT93C46 operates on a single power supply and will generate on chip the high voltage required during any write operation.

Instructions, addresses, and write data are clocked into the DI pin on the rising edge of the clock (SK). The DO pin is normally in a high impedance state except when reading data from the device, or when checking the ready/busy status during a write operation. The serial communication protocol follows the timing shown in Figure 2.

The ready/busy status can be determined after the start of internal write cycle by selecting the device (CS high) and polling the DO pin; DO low indicates that the write operation is not completed, while DO high indicates that the device is ready for the next instruction. If necessary, the DO pin may be placed back into a high impedance state during chip select by shifting a dummy “1” into the DI pin. The DO pin will enter the high impedance state on the rising edge of the clock (SK). Placing the DO pin into the high impedance state is recommended in applications where the DI pin and the DO pin are to be tied together to form a common DI/O pin. The Ready/Busy flag can be disabled only in Ready state; no change is allowed in Busy state.

The format for all instructions sent to the device is a logical “1” start bit, a 2-bit (or 4-bit) opcode, 6-bit address (an additional bit when organized X8) and for write operations a 16-bit data field (8-bit for X8 organization).

**Read**

Upon receiving a READ command (Figure 3) and an address (clocked into the DI pin), the DO pin of the CAT93C46 will come out of the high impedance state and, after sending an initial dummy zero bit, will begin shifting out the data addressed (MSB first). The output data bits will toggle on the rising edge of the SK clock and are stable after the specified time delay ( $t_{PD0}$  or  $t_{PD1}$ ).

After the initial data word has been shifted out and CS remains asserted with the SK clock continuing to toggle, the device will automatically increment to the next address and shift out the next data word in a sequential READ mode. As long as CS is continuously asserted and SK continues to toggle, the device will keep incrementing to the next address automatically until it reaches to the end of the address space, then loops back to address 0. In the sequential READ mode, only the initial data word is preceded by a dummy zero bit. All subsequent data words will follow without a dummy zero bit. *Note: The sequential READ mode is available for CAT93C46 New Product only.*

**Erase/Write Enable and Disable**

The CAT93C46 powers up in the write disable state. Any writing after power-up or after an EWDS (write disable) instruction must first be preceded by the EWEN (write enable) instruction. Once the write instruction is enabled, it will remain enabled until power to the device is removed, or the EWDS instruction is sent. The EWDS instruction can be used to disable all CAT93C46 write and erase instructions, and will prevent any accidental writing or clearing of the device. Data can be read normally from the device regardless of the write enable/disable status. The EWEN and EWDS instructions timing is shown in Figure 4.

**Table 10. INSTRUCTION SET**

Instruction	Start Bit	Opcode	Address		Data		Comments
			x8	x16	x8	x16	
READ	1	10	A6-A0	A5-A0			Read Address AN-A0
ERASE	1	11	A6-A0	A5-A0			Clear Address AN-A0
WRITE	1	01	A6-A0	A5-A0	D7-D0	D15-D0	Write Address AN-A0
EWEN	1	00	11XXXXX	11XXXX			Write Enable
EWDS	1	00	00XXXXX	00XXXX			Write Disable
ERAL*	1	00	10XXXXX	10XXXX			Clear All Addresses
WRAL*	1	00	01XXXXX	01XXXX	D7-D0	D15-D0	Write All Addresses

\* Not available at  $V_{CC} < 1.8 V$

# CAT93C46

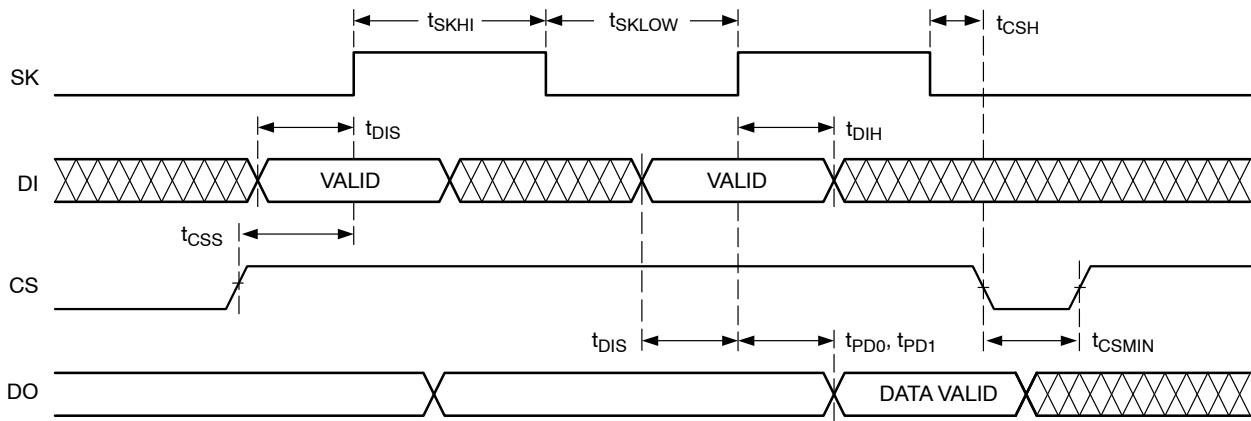

Figure 2. Synchronous Data Timing

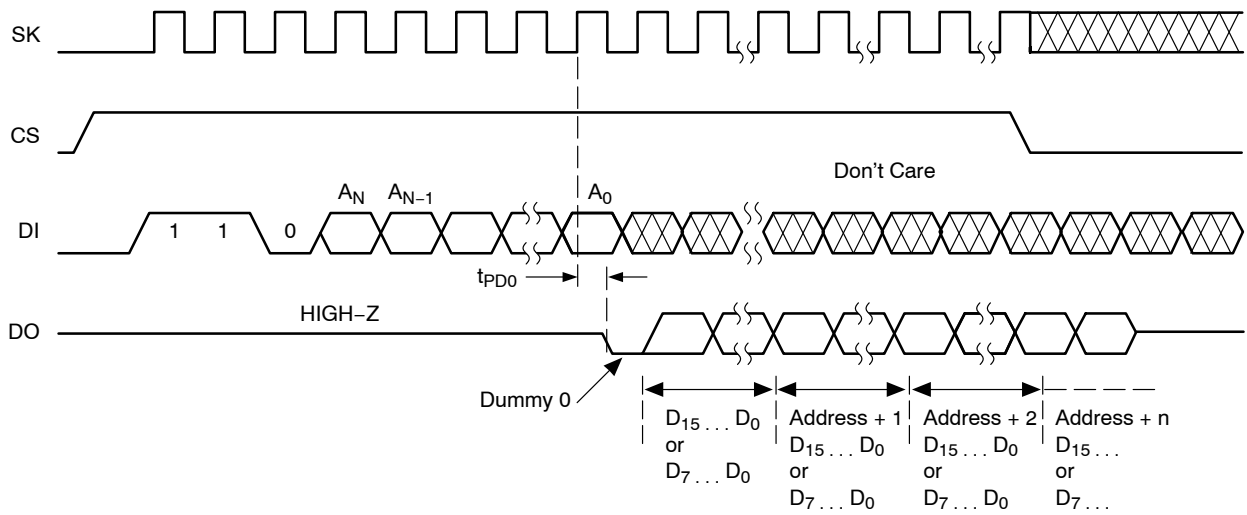

Figure 3. Read Instruction Timing

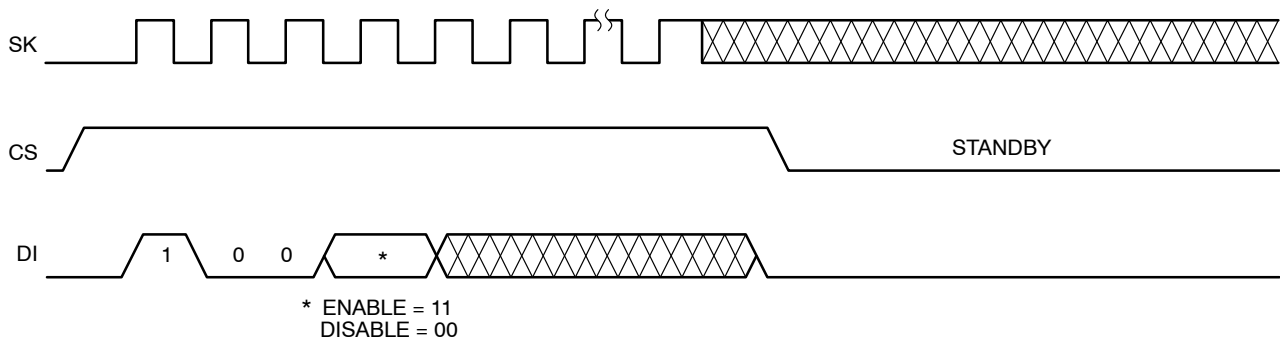

Figure 4. EWEN/EWDS Instruction Timing

# CAT93C46

## Write

After receiving a WRITE command (Figure 5), address and the data, the CS (Chip Select) pin must be deselected for a minimum of  $t_{CSMIN}$ . The falling edge of CS will start the self clocking for auto-clear and data store cycles on the memory location specified in the instruction. The clocking of the SK pin is not necessary after the device has entered the self clocking mode. The ready/busy status of the CAT93C46 can be determined by selecting the device and polling the DO pin. Since this device features Auto-Clear before write, it is NOT necessary to erase a memory location before it is written into.

## Erase

Upon receiving an ERASE command and address, the CS (Chip Select) pin must be de-asserted for a minimum of  $t_{CSMIN}$  (Figure 6). The falling edge of CS will start the self clocking clear cycle of the selected memory location. The clocking of the SK pin is not necessary after the device has entered the self clocking mode. The ready/busy status of the CAT93C46 can be determined by selecting the device and polling the DO pin. Once cleared, the content of a cleared location returns to a logical "1" state.

## Erase All

Upon receiving an ERAL command (Figure 7), the CS (Chip Select) pin must be deselected for a minimum of  $t_{CSMIN}$ . The falling edge of CS will start the self clocking clear cycle of all memory locations in the device. The clocking of the SK pin is not necessary after the device has entered the self clocking mode. The ready/busy status of the CAT93C46 can be determined by selecting the device and polling the DO pin. Once cleared, the contents of all memory bits return to a logical "1" state.

## Write All

Upon receiving a WRAL command and data, the CS (Chip Select) pin must be deselected for a minimum of  $t_{CSMIN}$  (Figure 8). The falling edge of CS will start the self clocking data write to all memory locations in the device. The clocking of the SK pin is not necessary after the device has entered the self clocking mode. The ready/busy status of the CAT93C46 can be determined by selecting the device and polling the DO pin. It is not necessary for all memory locations to be cleared before the WRAL command is executed.

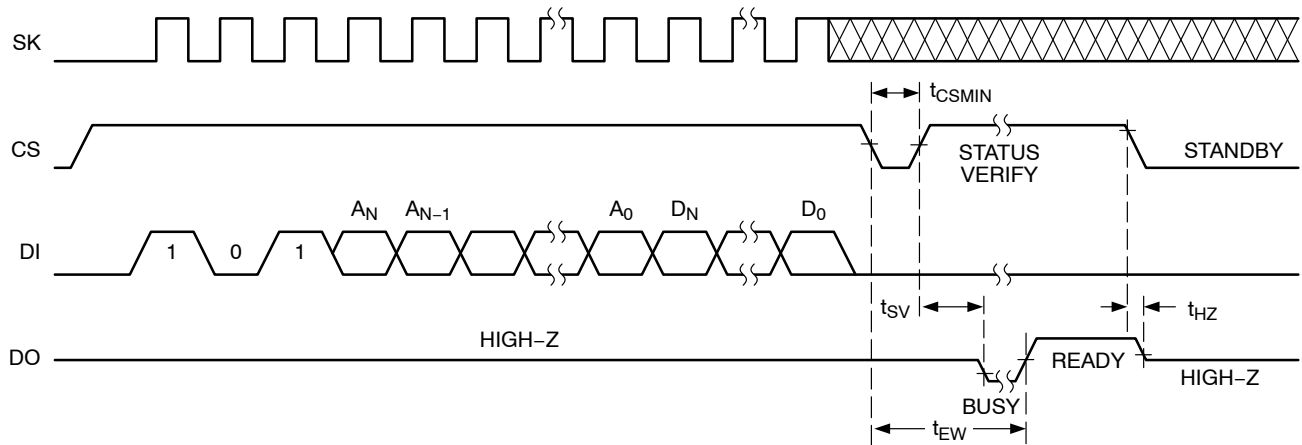

Figure 5. Write Instruction Timing

# CAT93C46



Figure 6. Erase Instruction Timing

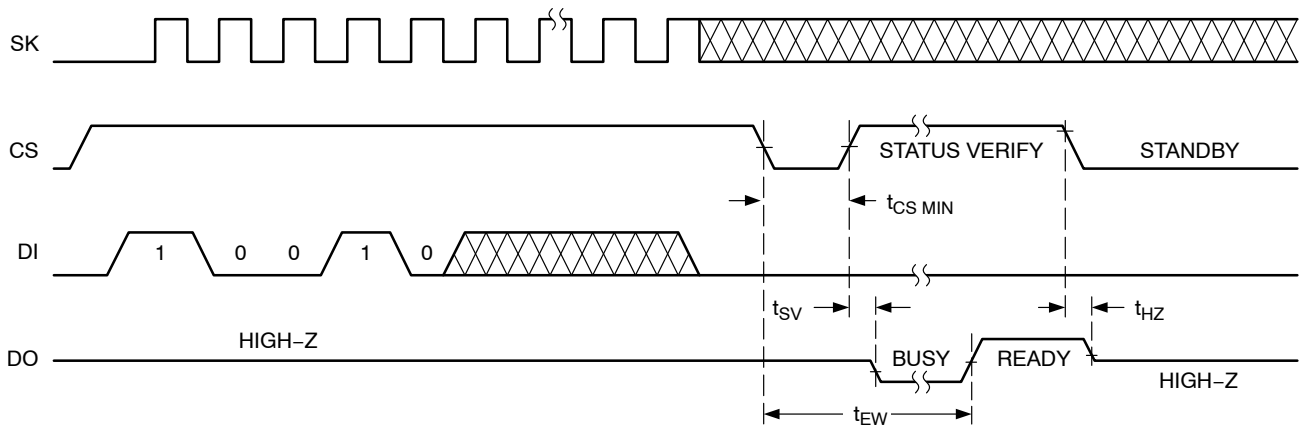

Figure 7. ERAL Instruction Timing

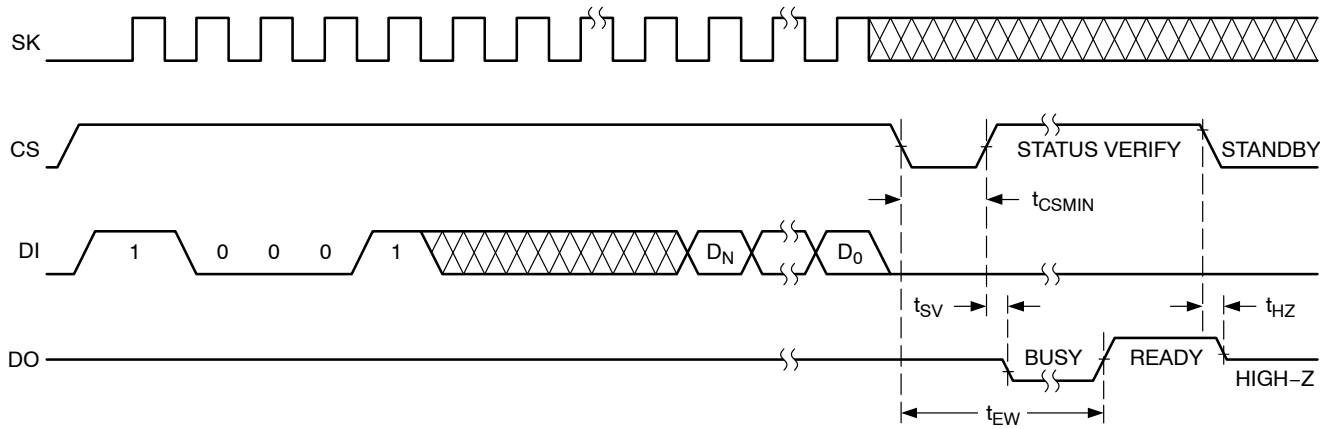

Figure 8. WRAL Instruction Timing



# CAT93C46

## PACKAGE DIMENSIONS

PDIP-8, 300 mils  
CASE 646AA-01  
ISSUE A



SYMBOL	MIN	NOM	MAX
A			5.33
A1	0.38		
A2	2.92	3.30	4.95
b	0.36	0.46	0.56
b2	1.14	1.52	1.78
c	0.20	0.25	0.36
D	9.02	9.27	10.16
E	7.62	7.87	8.25
E1	6.10	6.35	7.11
e	2.54 BSC		
eB	7.87		10.92
L	2.92	3.30	3.80

TOP VIEW

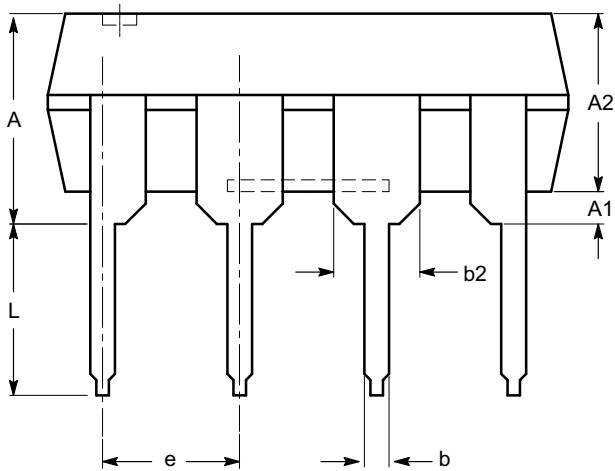

SIDE VIEW

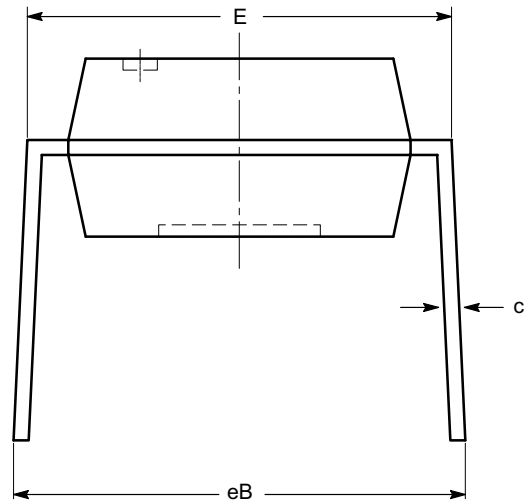

END VIEW

**Notes:**

- (1) All dimensions are in millimeters.
- (2) Complies with JEDEC MS-001.

# CAT93C46

## PACKAGE DIMENSIONS

SOIC 8, 150 mils  
CASE 751BD-01  
ISSUE O



TOP VIEW

SYMBOL	MIN	NOM	MAX
A	1.35		1.75
A1	0.10		0.25
b	0.33		0.51
c	0.19		0.25
D	4.80		5.00
E	5.80		6.20
E1	3.80		4.00
e	1.27 BSC		
h	0.25		0.50
L	0.40		1.27
$\theta$	0°		8°



SIDE VIEW

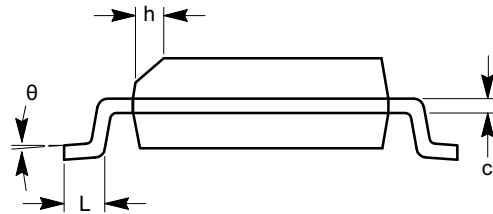

END VIEW

**Notes:**

- (1) All dimensions are in millimeters. Angles in degrees.
- (2) Complies with JEDEC MS-012.

# CAT93C46

## PACKAGE DIMENSIONS

SOIC-8, 208 mils  
CASE 751BE-01  
ISSUE O

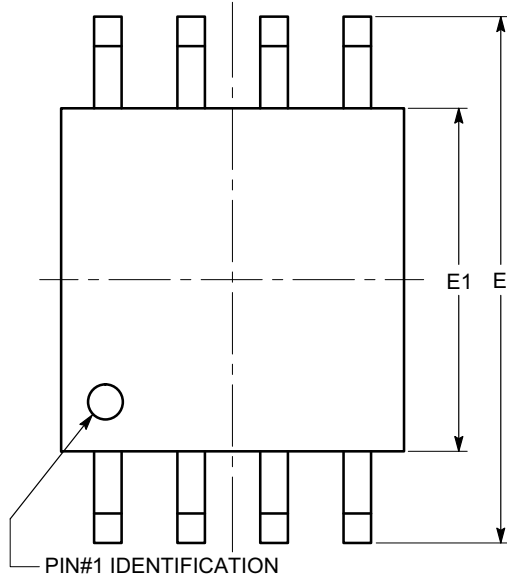

TOP VIEW

SYMBOL	MIN	NOM	MAX
A			2.03
A1	0.05		0.25
b	0.36		0.48
c	0.19		0.25
D	5.13		5.33
E	7.75		8.26
E1	5.13		5.38
e	1.27 BSC		
L	0.51		0.76
$\theta$	0°		8°

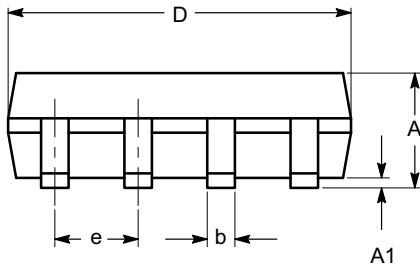

SIDE VIEW

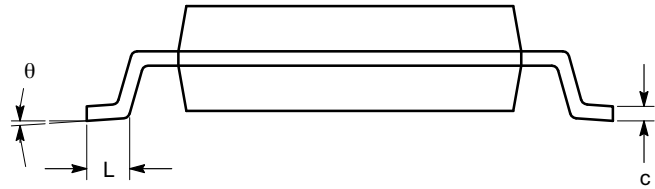

END VIEW

**Notes:**

- (1) All dimensions are in millimeters. Angles in degrees.
- (2) Complies with EIAJ EDR-7320.

# CAT93C46

## PACKAGE DIMENSIONS

TSSOP8, 4.4x3  
CASE 948AL-01  
ISSUE O

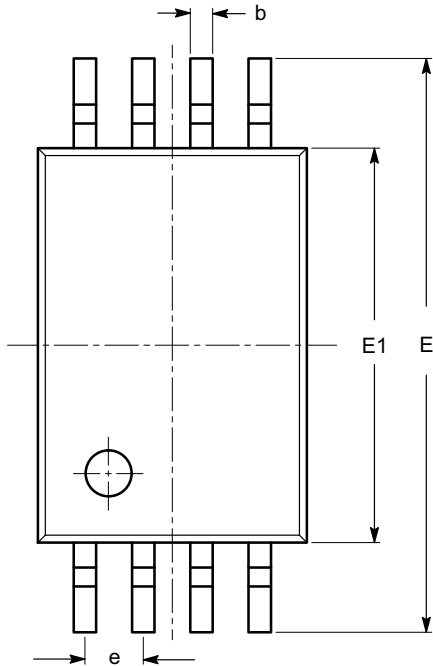

SYMBOL	MIN	NOM	MAX
A			1.20
A1	0.05		0.15
A2	0.80	0.90	1.05
b	0.19		0.30
c	0.09		0.20
D	2.90	3.00	3.10
E	6.30	6.40	6.50
E1	4.30	4.40	4.50
e	0.65 BSC		
L	1.00 REF		
L1	0.50	0.60	0.75
$\theta$	0°		8°

TOP VIEW

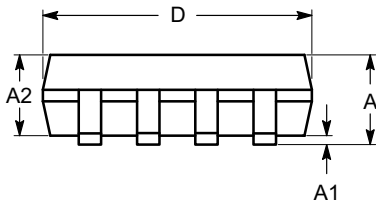

SIDE VIEW

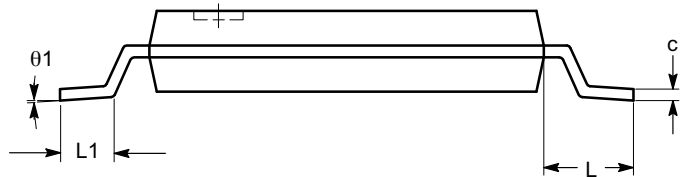

END VIEW

**Notes:**

- (1) All dimensions are in millimeters. Angles in degrees.
- (2) Complies with JEDEC MO-153.

# CAT93C46

## PACKAGE DIMENSIONS

UDFN8, 2x3 EXTENDED PAD  
CASE 517AZ-01  
ISSUE O

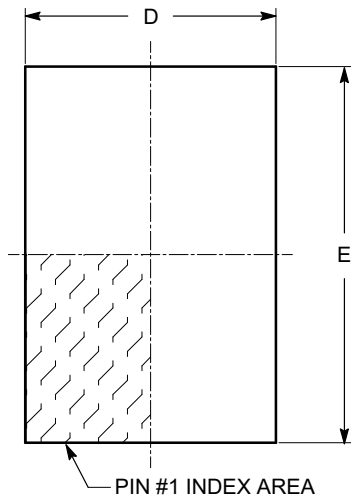

TOP VIEW

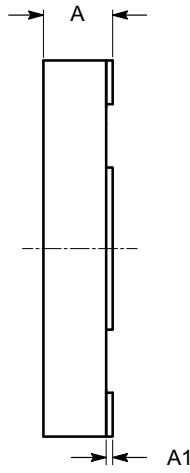

SIDE VIEW

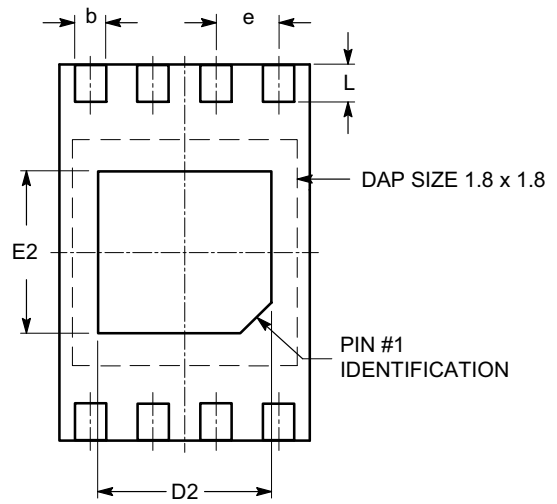

BOTTOM VIEW

SYMBOL	MIN	NOM	MAX
A	0.45	0.50	0.55
A1	0.00	0.02	0.05
A3	0.127 REF		
b	0.20	0.25	0.30
D	1.95	2.00	2.05
D2	1.35	1.40	1.45
E	2.95	3.00	3.05
E2	1.25	1.30	1.35
e	0.50 REF		
L	0.25	0.30	0.35

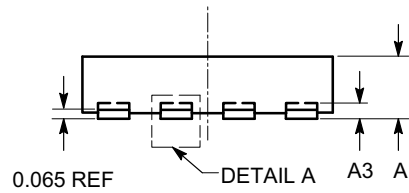

FRONT VIEW

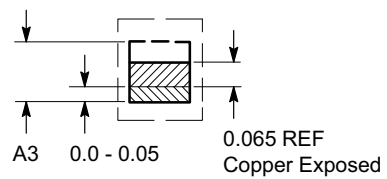

DETAIL A

**Notes:**

- (1) All dimensions are in millimeters.
- (2) Refer JEDEC MO-236/MO-252.

# CAT93C46

## PACKAGE DIMENSIONS

TDFN8, 2x3  
CASE 511AK-01  
ISSUE A

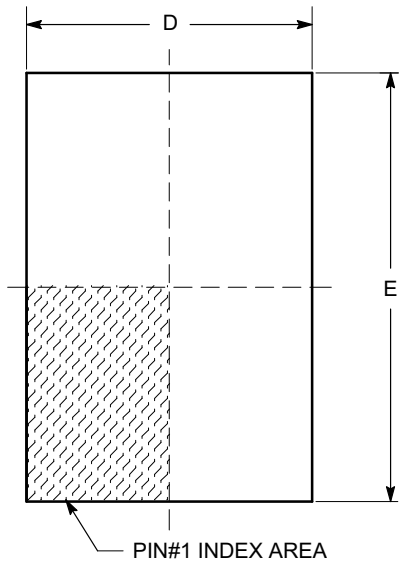

TOP VIEW

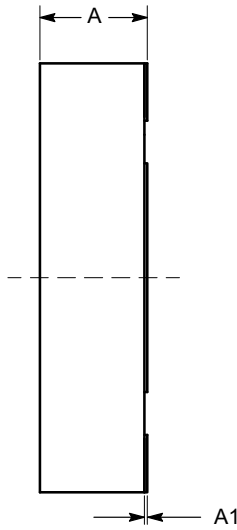

SIDE VIEW

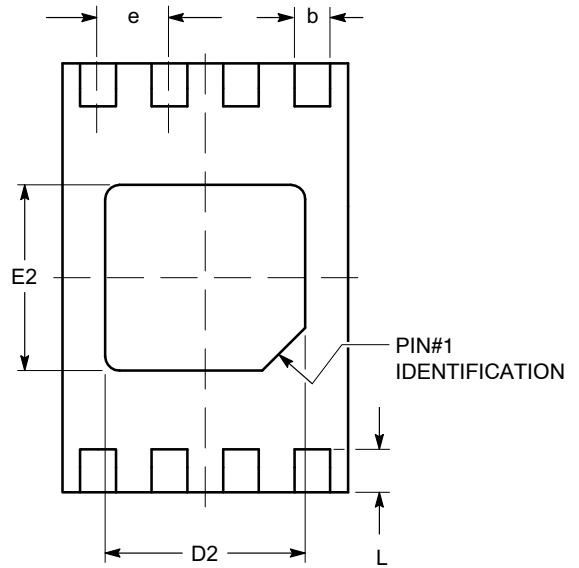

BOTTOM VIEW

SYMBOL	MIN	NOM	MAX
A	0.70	0.75	0.80
A1	0.00	0.02	0.05
A2	0.45	0.55	0.65
A3	0.20 REF		
b	0.20	0.25	0.30
D	1.90	2.00	2.10
D2	1.30	1.40	1.50
E	2.90	3.00	3.10
E2	1.20	1.30	1.40
e	0.50 TYP		
L	0.20	0.30	0.40

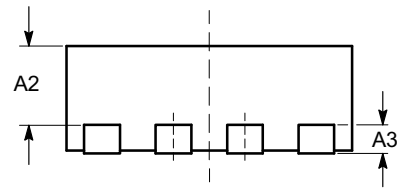

FRONT VIEW

**Notes:**

- (1) All dimensions are in millimeters.
- (2) Complies with JEDEC MO-229.

## CAT93C46

### Example of Ordering Information

Device Order Number	Specific Device Marking*	Package Type	Temperature Range	Lead Finish	Shipping
CAT93C46LI-G	93C46P	PDIP-8	I = Industrial (-40°C to +85°C)	NiPdAu	Tube, 50 Units / Tube
CAT93C46LE-G	93C46P	PDIP-8	E = Extended (-40°C to +125°C)	NiPdAu	Tube, 50 Units / Tube
CAT93C46VE-GT3	93C46P	SOIC-8, JEDEC	E = Extended (-40°C to +125°C)	NiPdAu	Tape & Reel, 3,000 Units / Reel
CAT93C46VI-G	93C46P	SOIC-8, JEDEC	I = Industrial (-40°C to +85°C)	NiPdAu	Tube, 100 Units / Tube
CAT93C46VI-GT3	93C46P	SOIC-8, JEDEC	I = Industrial (-40°C to +85°C)	NiPdAu	Tape & Reel, 3,000 Units / Reel
CAT93C46VI-GT3L	93C46P	SOIC-8, JEDEC	I = Industrial** (-20°C to +85°C)	NiPdAu	Tape & Reel, 3,000 Units / Reel
CAT93C46VP2I-GT3 (Note 10)	M0T	TDFN-8	I = Industrial (-40°C to +85°C)	NiPdAu	Tape & Reel, 3,000 Units / Reel
CAT93C46WI-G (Note 10)	93C46P	SOIC-8, JEDEC	I = Industrial (-40°C to +85°C)	NiPdAu	Tube, 100 Units / Tube
CAT93C46WI-GT3 (Note 10)	93C46P	SOIC-8, JEDEC	I = Industrial (-40°C to +85°C)	NiPdAu	Tape & Reel, 3,000 Units / Reel
CAT93C46XI-T2	93C46P	SOIC-8, EIAJ	I = Industrial (-40°C to +85°C)	Matte-Tin	Tape & Reel, 2,000 Units / Reel
CAT93C46XE-T2	93C46P	SOIC-8, EIAJ	E = Extended (-40°C to +125°C)	Matte-Tin	Tape & Reel, 2,000 Units / Reel
CAT93C46YI-G	M46P	TSSOP-8	I = Industrial (-40°C to +85°C)	NiPdAu	Tube, 100 Units / Tube
CAT93C46YI-GT3	M46P	TSSOP-8	I = Industrial (-40°C to +85°C)	NiPdAu	Tape & Reel, 3,000 Units / Reel
CAT93C46YI-GT3L	M46P	TSSOP-8	I = Industrial** (-20°C to +85°C)	NiPdAu	Tape & Reel, 3,000 Units / Reel
CAT93C46YE-GT3	M46P	TSSOP-8	E = Extended (-40°C to +125°C)	NiPdAu	Tape & Reel, 3,000 Units / Reel
CAT93C46HU4I-GT3	M0U	UDFN-8	I = Industrial (-40°C to +85°C)	NiPdAu	Tape & Reel, 3,000 Units / Reel
CAT93C46HU4E-GT3	M0U	UDFN-8	E = Extended (-40°C to +125°C)	NiPdAu	Tape & Reel, 3,000 Units / Reel

10. Not recommended for new designs.

11. All packages are RoHS-compliant (Lead-free, Halogen-free).

12. **The standard lead finish is NiPdAu.**

13. For additional package and temperature options, please contact your nearest ON Semiconductor Sales office.

14. For information on tape and reel specifications, including part orientation and tape sizes, please refer to our Tape and Reel Packaging Specifications Brochure, BRD8011/D.

15. For detailed information and a breakdown of device nomenclature and numbering systems, please see the ON Semiconductor Device Nomenclature document, TND310/D, available at [www.onsemi.com](http://www.onsemi.com)

\*Marking for New Product (Rev P)

\*\* Works only for the -20°C to +85°C interval of the Industrial range

# CAT93C46

**ON Semiconductor** and  are registered trademarks of Semiconductor Components Industries, LLC (SCILLC). SCILLC reserves the right to make changes without further notice to any products herein. SCILLC makes no warranty, representation or guarantee regarding the suitability of its products for any particular purpose, nor does SCILLC assume any liability arising out of the application or use of any product or circuit, and specifically disclaims any and all liability, including without limitation special, consequential or incidental damages. "Typical" parameters which may be provided in SCILLC data sheets and/or specifications can and do vary in different applications and actual performance may vary over time. All operating parameters, including "Typicals" must be validated for each customer application by customer's technical experts. SCILLC does not convey any license under its patent rights nor the rights of others. SCILLC products are not designed, intended, or authorized for use as components in systems intended for surgical implant into the body, or other applications intended to support or sustain life, or for any other application in which the failure of the SCILLC product could create a situation where personal injury or death may occur. Should Buyer purchase or use SCILLC products for any such unintended or unauthorized application, Buyer shall indemnify and hold SCILLC and its officers, employees, subsidiaries, affiliates, and distributors harmless against all claims, costs, damages, and expenses, and reasonable attorney fees arising out of, directly or indirectly, any claim of personal injury or death associated with such unintended or unauthorized use, even if such claim alleges that SCILLC was negligent regarding the design or manufacture of the part. SCILLC is an Equal Opportunity/Affirmative Action Employer. This literature is subject to all applicable copyright laws and is not for resale in any manner.

## PUBLICATION ORDERING INFORMATION

### LITERATURE FULFILLMENT:

Literature Distribution Center for ON Semiconductor  
P.O. Box 5163, Denver, Colorado 80217 USA  
**Phone:** 303-675-2175 or 800-344-3860 Toll Free USA/Canada  
**Fax:** 303-675-2176 or 800-344-3867 Toll Free USA/Canada  
**Email:** [orderlit@onsemi.com](mailto:orderlit@onsemi.com)

**N. American Technical Support:** 800-282-9855 Toll Free  
USA/Canada  
**Europe, Middle East and Africa Technical Support:**  
Phone: 421 33 790 2910  
**Japan Customer Focus Center**  
Phone: 81-3-5817-1050

**ON Semiconductor Website:** [www.onsemi.com](http://www.onsemi.com)

**Order Literature:** <http://www.onsemi.com/orderlit>

For additional information, please contact your local Sales Representative



Компания «Океан Электроники» предлагает заключение долгосрочных отношений при поставках импортных электронных компонентов на взаимовыгодных условиях!

Наши преимущества:

- Поставка оригинальных импортных электронных компонентов напрямую с производств Америки, Европы и Азии, а так же с крупнейших складов мира;
- Широкая линейка поставок активных и пассивных импортных электронных компонентов (более 30 млн. наименований);
- Поставка сложных, дефицитных, либо снятых с производства позиций;
- Оперативные сроки поставки под заказ (от 5 рабочих дней);
- Экспресс доставка в любую точку России;
- Помощь Конструкторского Отдела и консультации квалифицированных инженеров;
- Техническая поддержка проекта, помощь в подборе аналогов, поставка прототипов;
- Поставка электронных компонентов под контролем ВП;
- Система менеджмента качества сертифицирована по Международному стандарту ISO 9001;
- При необходимости вся продукция военного и аэрокосмического назначения проходит испытания и сертификацию в лаборатории (по согласованию с заказчиком);
- Поставка специализированных компонентов военного и аэрокосмического уровня качества (Xilinx, Altera, Analog Devices, Intersil, Interpoint, Microsemi, Actel, Aeroflex, Peregrine, VPT, Syfer, Eurofarad, Texas Instruments, MS Kennedy, Miteq, Cobham, E2V, MA-COM, Hittite, Mini-Circuits, General Dynamics и др.);

Компания «Океан Электроники» является официальным дистрибьютором и эксклюзивным представителем в России одного из крупнейших производителей разъемов военного и аэрокосмического назначения «**JONHON**», а так же официальным дистрибьютором и эксклюзивным представителем в России производителя высокотехнологичных и надежных решений для передачи СВЧ сигналов «**FORSTAR**».



## JONHON

«**JONHON**» (основан в 1970 г.)

Разъемы специального, военного и аэрокосмического назначения:

(Применяются в военной, авиационной, аэрокосмической, морской, железнодорожной, горно- и нефтедобывающей отраслях промышленности)

«**FORSTAR**» (основан в 1998 г.)

ВЧ соединители, коаксиальные кабели,  
кабельные сборки и микроволновые компоненты:

(Применяются в телекоммуникациях гражданского и специального назначения, в средствах связи, РЛС, а так же военной, авиационной и аэрокосмической отраслях промышленности).



Телефон: 8 (812) 309-75-97 (многоканальный)

Факс: 8 (812) 320-03-32

Электронная почта: [ocean@oceanchips.ru](mailto:ocean@oceanchips.ru)

Web: <http://oceanchips.ru/>

Адрес: 198099, г. Санкт-Петербург, ул. Калинина, д. 2, корп. 4, лит. А