

| | |
|-------|------|
| V_R | 650V |
| I_F | 10A |
| Q_C | 15nC |

●Features

- 1) Shorter recovery time
- 2) Reduced temperature dependence
- 3) High-speed switching possible

●Applications

- PFC Boost Topology
- Secondary Side Rectification
- Data Center
- PV Power Conditioners

●Outline

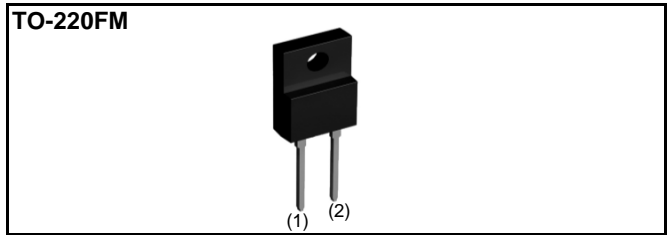

●Inner circuit

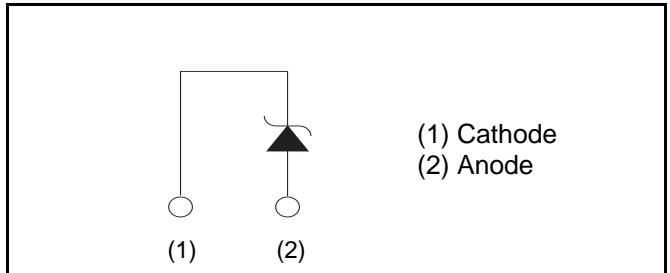

●Packaging specifications

| Type | Packaging | Tube |
|------|---------------------------|----------|
| | Reel size (mm) | - |
| | Tape width (mm) | - |
| | Basic ordering unit (pcs) | 50 |
| | Packing code | C |
| | Marking | SCS210AM |

●Absolute maximum ratings ($T_j = 25^\circ\text{C}$)

| Parameter | Symbol | Value | Unit | |
|---|---------------|--|------------------|----------------------|
| Reverse voltage (repetitive peak) | V_{RM} | 650 | V | |
| Reverse voltage (DC) | V_R | 650 | V | |
| Continuous forward current ($T_c = 85^\circ\text{C}$) | I_F | 10 | A | |
| Surge non-repetitive forward current | I_{FSM} | PW=10ms sinusoidal, $T_j=25^\circ\text{C}$ | 38 | A |
| | | PW=10ms sinusoidal, $T_j=150^\circ\text{C}$ | 30 | A |
| | | PW=10 μs square, $T_j=25^\circ\text{C}$ | 150 | A |
| Repetitive peak forward current | I_{FRM} | 28 *1 | A | |
| i^2t value | $\int i^2 dt$ | PW=10ms, $T_j=25^\circ\text{C}$ | 7.2 | A^2s |
| | | PW=10ms, $T_j=150^\circ\text{C}$ | 4.5 | A^2s |
| Total power dissipation | P_D | 34 *2 | W | |
| Junction temperature | T_j | 175 | $^\circ\text{C}$ | |
| Range of storage temperature | T_{stg} | -55 to +175 | $^\circ\text{C}$ | |

*1 $T_c=100^\circ\text{C}$, $T_j=150^\circ\text{C}$, Duty cycle=10% *2 $T_c=25^\circ\text{C}$

●Electrical characteristics ($T_j = 25^\circ\text{C}$)

| Parameter | Symbol | Conditions | Values | | | Unit |
|-------------------------|----------|--|--------|------|------|---------------|
| | | | Min. | Typ. | Max. | |
| DC blocking voltage | V_{DC} | $I_R=2.0\text{mA}$ | 650 | - | - | V |
| Forward voltage | V_F | $I_F=10\text{A}, T_j=25^\circ\text{C}$ | - | 1.35 | 1.55 | V |
| | | $I_F=10\text{A}, T_j=150^\circ\text{C}$ | - | 1.55 | - | V |
| | | $I_F=10\text{A}, T_j=175^\circ\text{C}$ | - | 1.63 | - | V |
| Reverse current | I_R | $V_R=650\text{V}, T_j=25^\circ\text{C}$ | - | 2 | 200 | μA |
| | | $V_R=650\text{V}, T_j=150^\circ\text{C}$ | - | 30 | - | μA |
| | | $V_R=650\text{V}, T_j=175^\circ\text{C}$ | - | 70 | - | μA |
| Total capacitance | C | $V_R=1\text{V}, f=1\text{MHz}$ | - | 360 | - | pF |
| | | $V_R=600\text{V}, f=1\text{MHz}$ | - | 37 | - | pF |
| Total capacitive charge | Q_C | $V_R=400\text{V}, di/dt=350\text{A}/\mu\text{s}$ | - | 15 | - | nC |
| Switching time | t_C | $V_R=400\text{V}, di/dt=350\text{A}/\mu\text{s}$ | - | 15 | - | ns |

●Thermal characteristics

| Parameter | Symbol | Conditions | Values | | | Unit |
|--------------------|---------------|------------|--------|------|------|---------------------------|
| | | | Min. | Typ. | Max. | |
| Thermal resistance | $R_{th(j-c)}$ | - | - | 3.6 | 4.3 | $^\circ\text{C}/\text{W}$ |

●Typical Transient Thermal Characteristics

| Symbol | Value | Unit | Symbol | Value | Unit |
|-----------|----------|------|------------|----------|------|
| R_{th1} | 7.04E-01 | K/W | C_{th1} | 1.89E-03 | Ws/K |
| R_{th2} | 1.29E+00 | | C_{th2} | 8.38E-03 | |
| R_{th3} | 1.62E+00 | | $C_{th,n}$ | 7.07E-01 | |

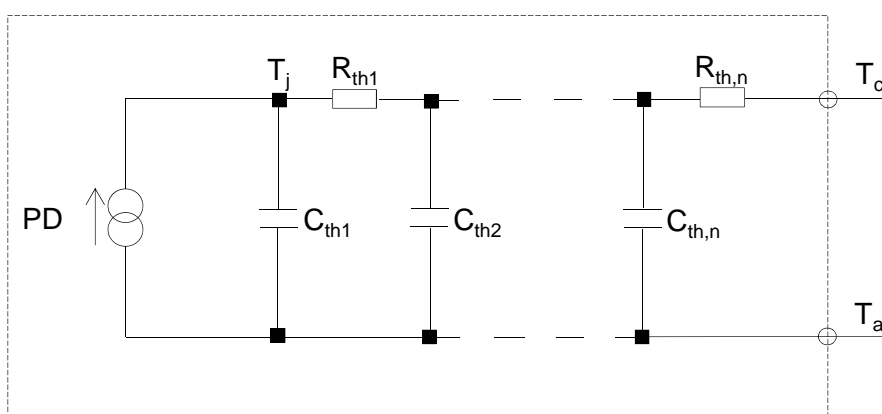

●Electrical characteristic curves

Fig.1 $V_F - I_F$ Characteristics

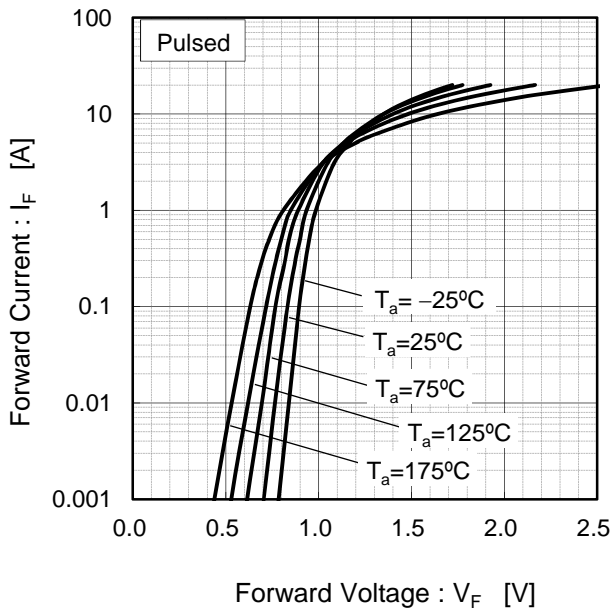

Fig.2 $V_F - I_F$ Characteristics

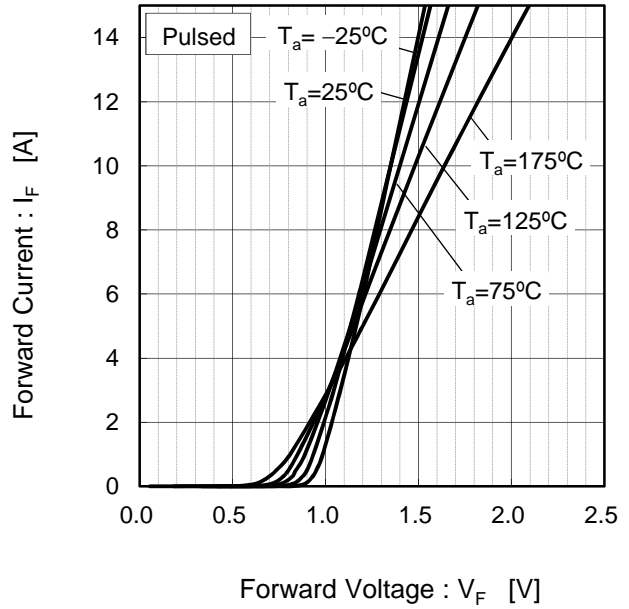

Fig.3 $V_R - I_R$ Characteristics

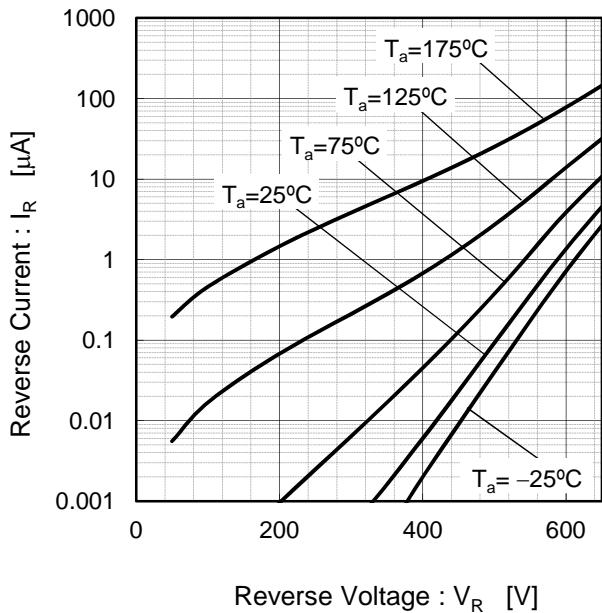
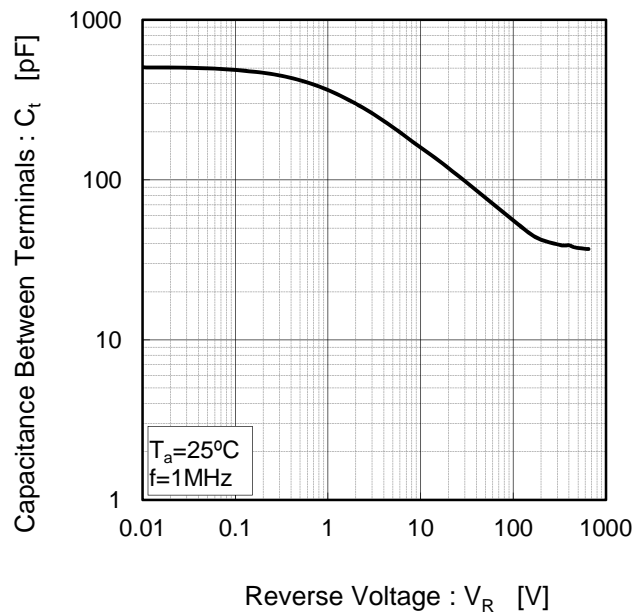

Fig.4 $V_R - C_t$ Characteristics



●Electrical characteristic curves

Fig.5 Typical Transient Thermal Resistance vs. Pulse Width

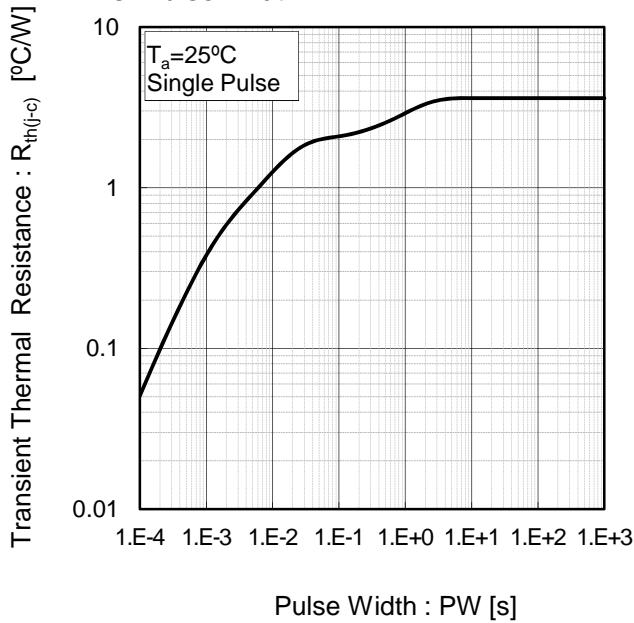

Fig.6 Power Dissipation

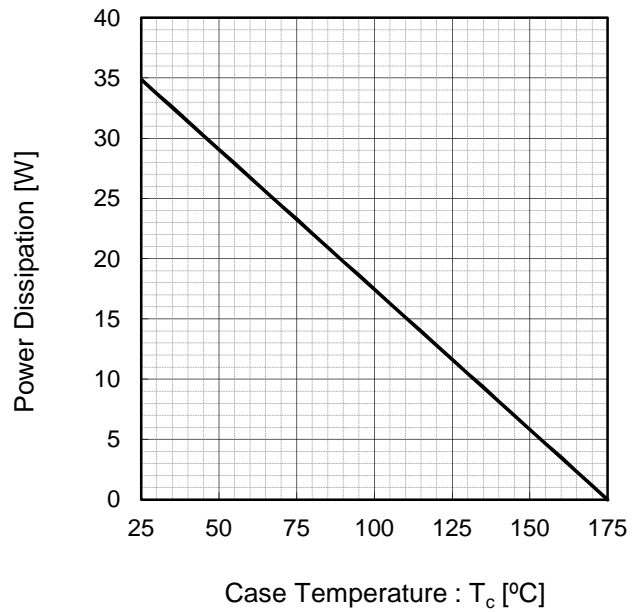
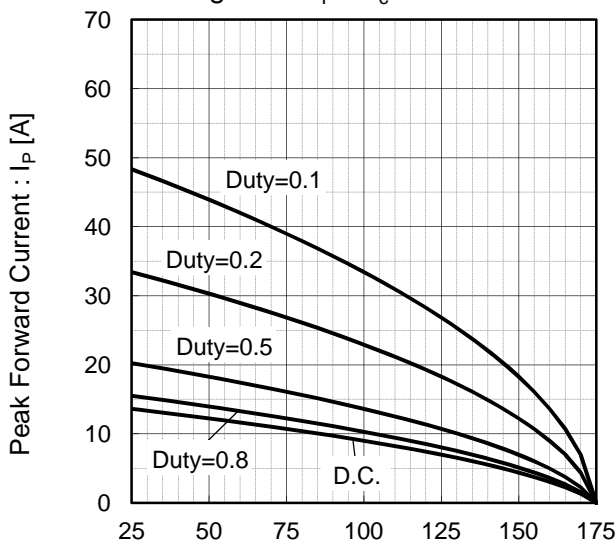
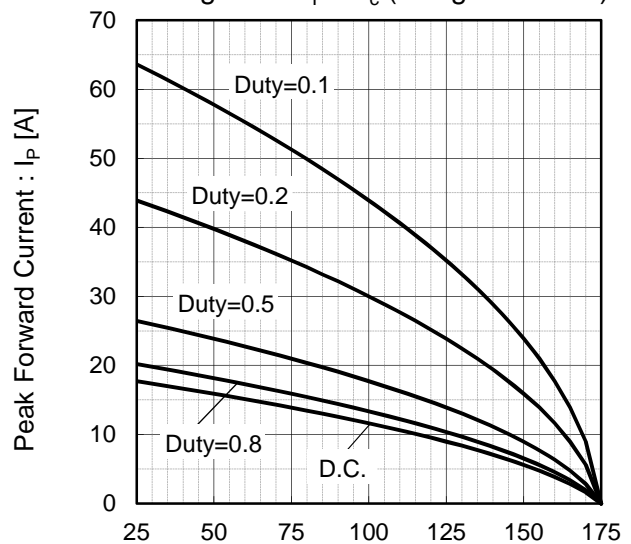

Fig.7*3 Maximum peak forward current derating curve $I_P - T_c$



Case Temperature : T_c [°C]
 *3 Based on max Vf, max $R_{th(j-c)}$
 Valid for switching of above 10kHz,
 excluding D.C. curve.

Fig.8*4 Typical peak forward current derating curve $I_P - T_c$ (Not guaranteed)



Case Temperature : T_c [°C]
 *4 Based on typ Vf, typ $R_{th(j-c)}$
 Typical value, not guaranteed
 Valid for switching of above 10kHz,
 excluding D.C. curve

●Electrical characteristic curves

Fig.9 Surge non-repetitive forward current vs. Pulse width (Sinusoidal waveform)

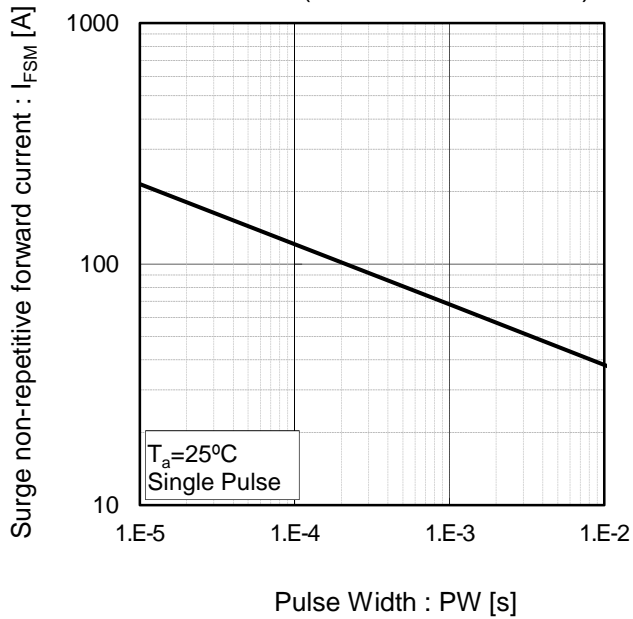
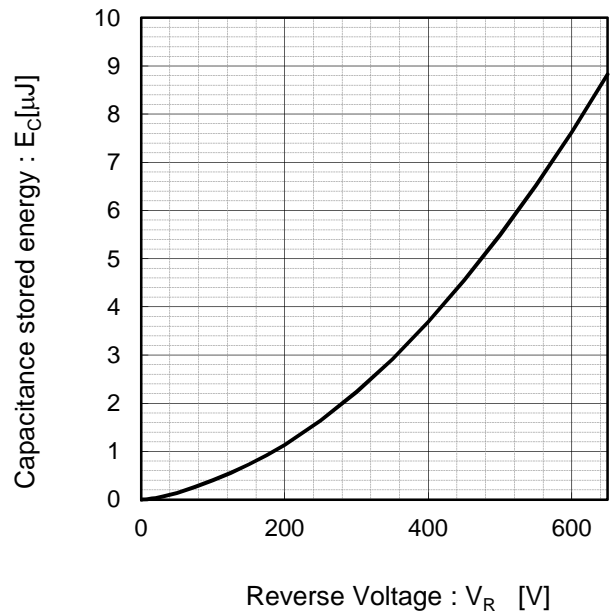

Fig.10 Typical capacitance store energy



●Simplified forward characteristic model

Fig.11 Equivalent forward current curve



$$V_F = V_{th} + R_{diff} I_F$$

$$V_{th} (T_j) = a_0 + a_1 T_j$$

$$R_{diff} (T_j) = b_0 + b_1 T_j + b_2 T_j^2$$

| Symbol | Typical Value | Unit |
|----------------|---------------|-------------------|
| a ₀ | 9.35E-01 | V |
| a ₁ | -1.12E-03 | V/°C |
| b ₀ | 3.98E-02 | Ω |
| b ₁ | 1.02E-04 | Ω/°C |
| b ₂ | 1.08E-06 | Ω/°C ² |

T_j in °C; -55 °C < T_j < °C ; I_F < 20 A

Notes

- 1) The information contained herein is subject to change without notice.
- 2) Before you use our Products, please contact our sales representative and verify the latest specifications :
- 3) Although ROHM is continuously working to improve product reliability and quality, semiconductors can break down and malfunction due to various factors.
Therefore, in order to prevent personal injury or fire arising from failure, please take safety measures such as complying with the derating characteristics, implementing redundant and fire prevention designs, and utilizing backups and fail-safe procedures. ROHM shall have no responsibility for any damages arising out of the use of our Products beyond the rating specified by ROHM.
- 4) Examples of application circuits, circuit constants and any other information contained herein are provided only to illustrate the standard usage and operations of the Products. The peripheral conditions must be taken into account when designing circuits for mass production.
- 5) The technical information specified herein is intended only to show the typical functions of and examples of application circuits for the Products. ROHM does not grant you, explicitly or implicitly, any license to use or exercise intellectual property or other rights held by ROHM or any other parties. ROHM shall have no responsibility whatsoever for any dispute arising out of the use of such technical information.
- 6) The Products specified in this document are not designed to be radiation tolerant.
- 7) For use of our Products in applications requiring a high degree of reliability (as exemplified below), please contact and consult with a ROHM representative : transportation equipment (i.e. cars, ships, trains), primary communication equipment, traffic lights, fire/crime prevention, safety equipment, medical systems, and power transmission systems.
- 8) Do not use our Products in applications requiring extremely high reliability, such as aerospace equipment, nuclear power control systems, and submarine repeaters.
- 9) ROHM shall have no responsibility for any damages or injury arising from non-compliance with the recommended usage conditions and specifications contained herein.
- 10) ROHM has used reasonable care to ensure the accuracy of the information contained in this document. However, ROHM does not warrant that such information is error-free, and ROHM shall have no responsibility for any damages arising from any inaccuracy or misprint of such information.
- 11) Please use the Products in accordance with any applicable environmental laws and regulations, such as the RoHS Directive. For more details, including RoHS compatibility, please contact a ROHM sales office. ROHM shall have no responsibility for any damages or losses resulting from non-compliance with any applicable laws or regulations.
- 12) When providing our Products and technologies contained in this document to other countries, you must abide by the procedures and provisions stipulated in all applicable export laws and regulations, including without limitation the US Export Administration Regulations and the Foreign Exchange and Foreign Trade Act.
- 13) This document, in part or in whole, may not be reprinted or reproduced without prior consent of ROHM.



Thank you for your accessing to ROHM product informations.
More detail product informations and catalogs are available, please contact us.

ROHM Customer Support System

<http://www.rohm.com/contact/>

Mouser Electronics

Authorized Distributor

Click to View Pricing, Inventory, Delivery & Lifecycle Information:

[ROHM Semiconductor:](#)

[SCS210AMC](#)

Компания «Океан Электроники» предлагает заключение долгосрочных отношений при поставках импортных электронных компонентов на взаимовыгодных условиях!

Наши преимущества:

- Поставка оригинальных импортных электронных компонентов напрямую с производств Америки, Европы и Азии, а так же с крупнейших складов мира;
- Широкая линейка поставок активных и пассивных импортных электронных компонентов (более 30 млн. наименований);
- Поставка сложных, дефицитных, либо снятых с производства позиций;
- Оперативные сроки поставки под заказ (от 5 рабочих дней);
- Экспресс доставка в любую точку России;
- Помощь Конструкторского Отдела и консультации квалифицированных инженеров;
- Техническая поддержка проекта, помощь в подборе аналогов, поставка прототипов;
- Поставка электронных компонентов под контролем ВП;
- Система менеджмента качества сертифицирована по Международному стандарту ISO 9001;
- При необходимости вся продукция военного и аэрокосмического назначения проходит испытания и сертификацию в лаборатории (по согласованию с заказчиком);
- Поставка специализированных компонентов военного и аэрокосмического уровня качества (Xilinx, Altera, Analog Devices, Intersil, Interpoint, Microsemi, Actel, Aeroflex, Peregrine, VPT, Syfer, Eurofarad, Texas Instruments, MS Kennedy, Miteq, Cobham, E2V, MA-COM, Hittite, Mini-Circuits, General Dynamics и др.);

Компания «Океан Электроники» является официальным дистрибьютором и эксклюзивным представителем в России одного из крупнейших производителей разъемов военного и аэрокосмического назначения «JONHON», а так же официальным дистрибьютором и эксклюзивным представителем в России производителя высокотехнологичных и надежных решений для передачи СВЧ сигналов «FORSTAR».



JONHON

«JONHON» (основан в 1970 г.)

Разъемы специального, военного и аэрокосмического назначения:

(Применяются в военной, авиационной, аэрокосмической, морской, железнодорожной, горно- и нефтедобывающей отраслях промышленности)

«FORSTAR» (основан в 1998 г.)

ВЧ соединители, коаксиальные кабели,
кабельные сборки и микроволновые компоненты:

(Применяются в телекоммуникациях гражданского и специального назначения, в средствах связи, РЛС, а так же военной, авиационной и аэрокосмической отраслях промышленности).



Телефон: 8 (812) 309-75-97 (многоканальный)

Факс: 8 (812) 320-03-32

Электронная почта: ocean@oceanchips.ru

Web: <http://oceanchips.ru/>

Адрес: 198099, г. Санкт-Петербург, ул. Калинина, д. 2, корп. 4, лит. А