

# Broadening the Tektronix Signal Source Portfolio

Cost efficient signal generation



**Tektronix**<sup>®</sup>

# Introducing a Full Featured Bench Top Arbitrary Function Generator for the Value Segment

**Standard  
3 year  
warranty**

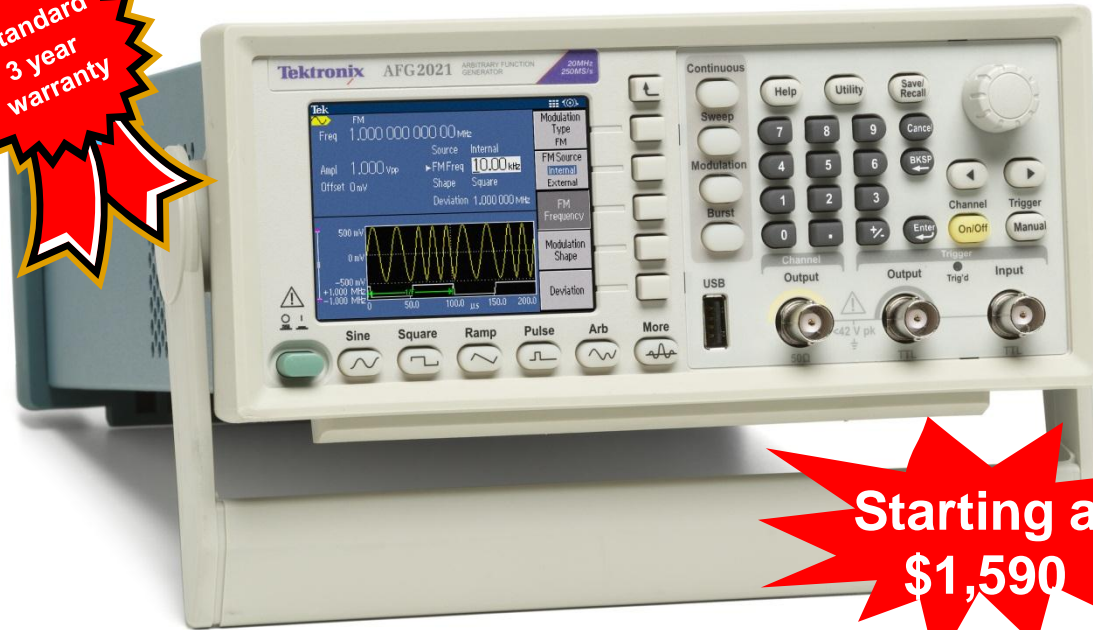

***Proven AFG  
Technology for price  
sensitive customers!***

**Starting at  
\$1,590**

Model	Bandwidth	Channel	Sample rate	Resolution	Interface	MSRP in US
AFG2021	20MHz	1	250MS/s	14bit	USB Host & Device	\$1,590
AFG2021 (with GL option)	20MHz	1	250MS/s	14bit	USB Host & Device, GPIB and LAN	\$1,690

# Best-in-class Performance

## AFG2000 Series Overview

### Performance

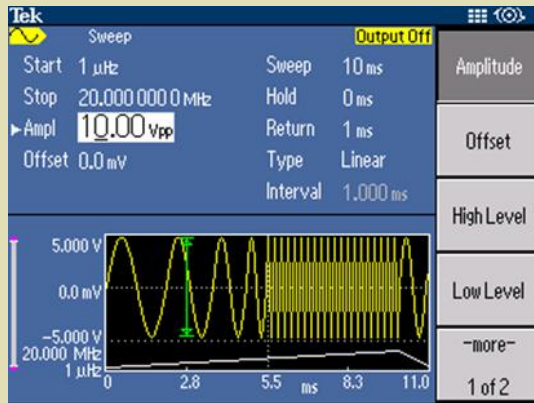

- Leverages industry leading AFG3000 technology & UI
- 1  $\mu$ Hz~20MHz sine
- 250MS/s sample rate
- 1ppm stability
- 14bit vertical resolution
- 10Vpp into 50ohm load

### Flexibility



- 12 built-in standard waveforms
- 4 distinct run modes
- Built-in noise generator
- Easily share waveform & set-up data with AFG3000 models

### Versatility



- Compact form factor
- Optional GPIB and LAN
- Free ArbExpress and SignalExpress productivity software

# Superior Features at an Affordable Price

- 20MHz bandwidth
- 14bit vertical resolution
- 250MS/s sample rate
- 12 built-in standard waveforms
- Continues, sweep, modulation and burst modes
- 4 × 128 KS built-in memory and USB memory expansion for user defined waveforms

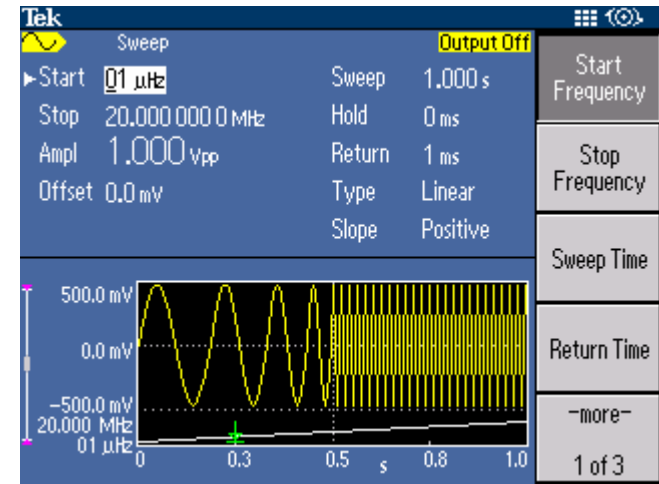

*Enabling end user to quickly generate simple or complex waveforms to exercise their designs*

# Leveraging Proven AFG3000 Technology

- The innovative ease-of-use features first seen on AFG3000 are the building blocks for the AFG2021
  - A 3.5 in color TFT LCD shows the relevant settings in both graphic and text formats
  - The shortcut buttons and rotary knob allow easy access to the most frequently used settings and functions
  
- Menu and online help are available in 8 languages
  
- The AFG3000 customers can migrate to AFG2021 quickly without having to learn a new User Interface

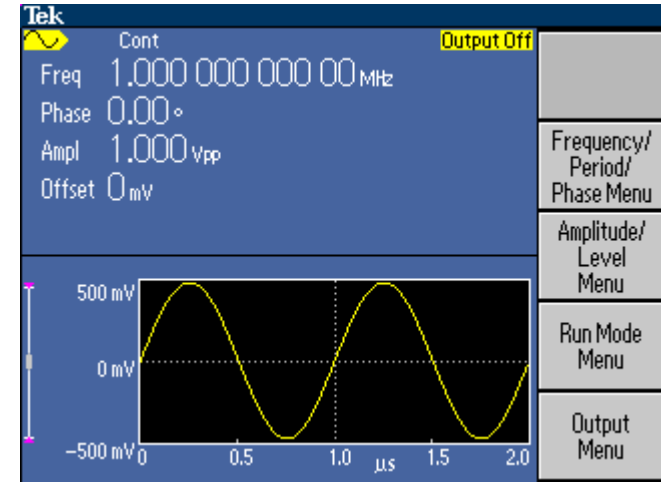

# Efficient Shortcuts to High Frequency

- DDS technology enables accurate, easy and on-the-fly changes to frequency and phase characteristics
  - 1uHz to 20MHz sine wave, 1uHz or 12digits frequency resolution
  - $-180^\circ \sim 180^\circ$  phase range,  $0.01^\circ$  resolution
- High stability time base
  - $\pm 1$ ppm internal frequency reference
  - 1ppm per year aging

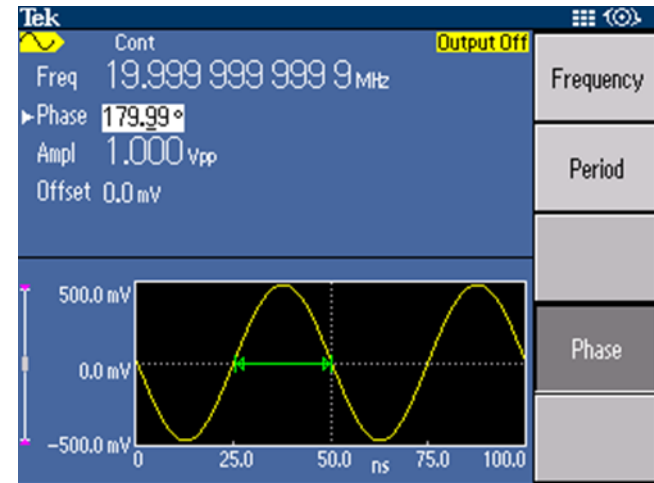



# Connectivity

- Standard USB Host and Device, Optional GPIB and LAN
  - Customized waveforms and settings can be saved in USB memory sticks, and recalled for later use, via the front panel USB host socket
  - USB device, GPIB and LAN fulfills the connectivity requirements to download waveforms to the instrument and remote control from a PC

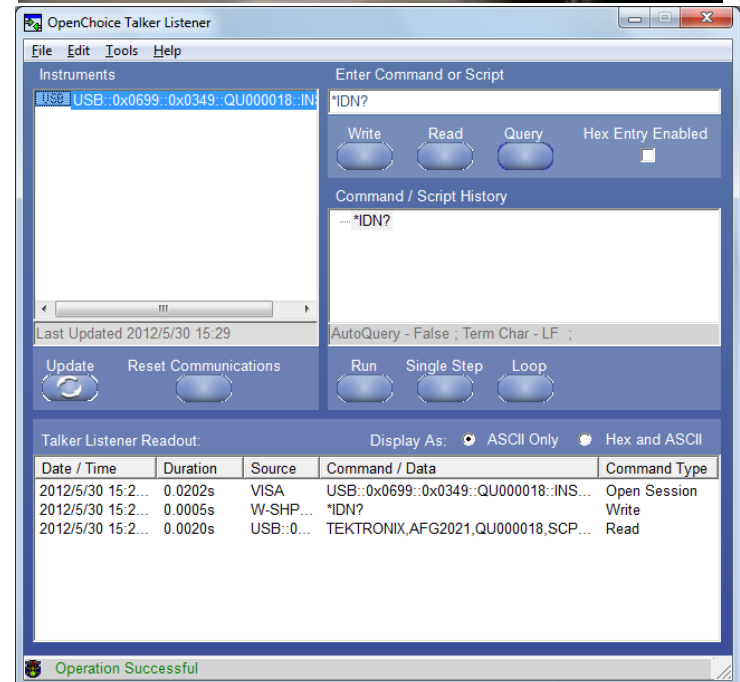

## ArbExpress® Real-world Waveform Replication Made Easy

- The ArbExpress waveform editing software ships free with every unit
- Convenient way to create and edit customized waveforms
  - Use standard waveforms as templates
  - Use freehand draw, equation editor or point draw modes
- Compatible to Tek oscilloscopes for direct loading of captured signals onto the host PC
- Download created/captured waveforms to AFG for replication via USB, GPIB or LAN connections.
- Facilitates control the AFG2000 remotely

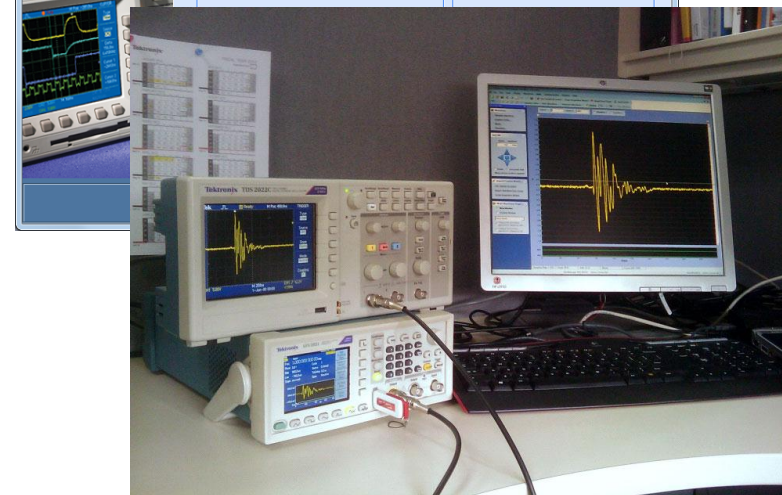
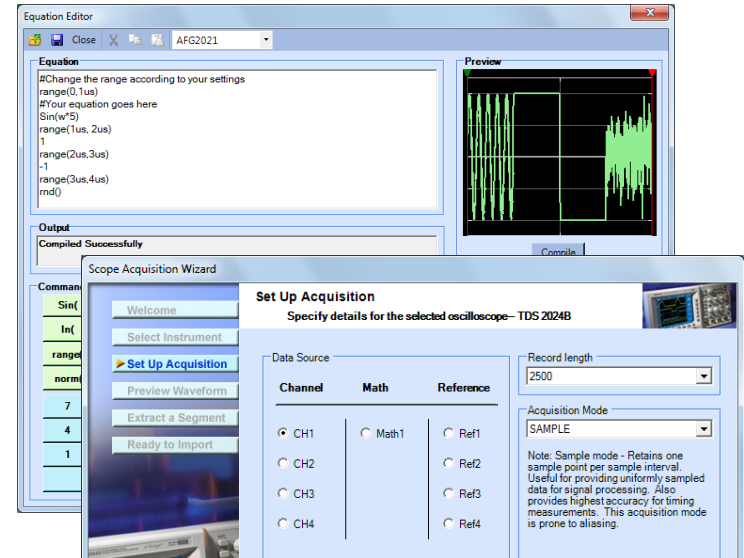



# Increase Productivity with SignalExpress

- National Instruments LabView SignalExpress LE version ships free with every unit
- Integrates AFG2021 to the whole Tektronix Bench portfolio
- Intuitive drag-and-drop interface provides an alternative to writing complex software routines
  - Basic instrument control
  - Data logging
  - Data analysis
  - Measurement trending
  - Documentation

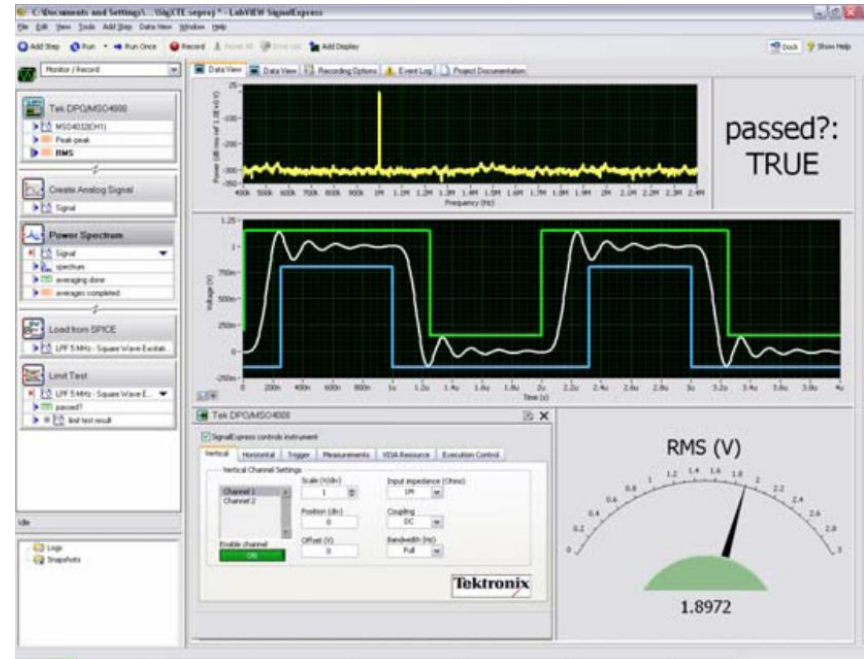

# Compact Form Factor

- The standard 2U height and half-rack width form factor fits both bench top and rack mount applications
- Stackable
  - Easily stack on other Tektronix bench instruments
  - Save valuable bench top space
- Perfect option for ATE and system integration
  - Available RMU2U rack mount kit simplifies rack mount requirements
  - Full support for GPIB & SCPI command environments

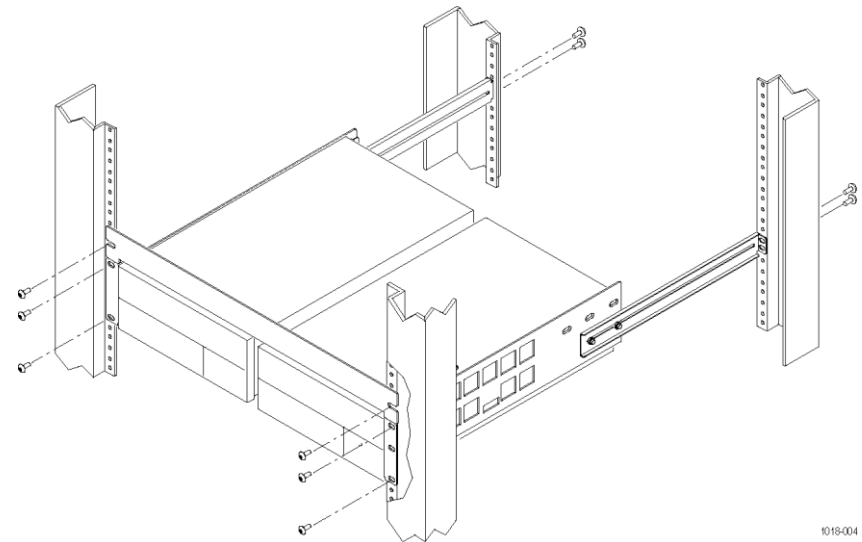
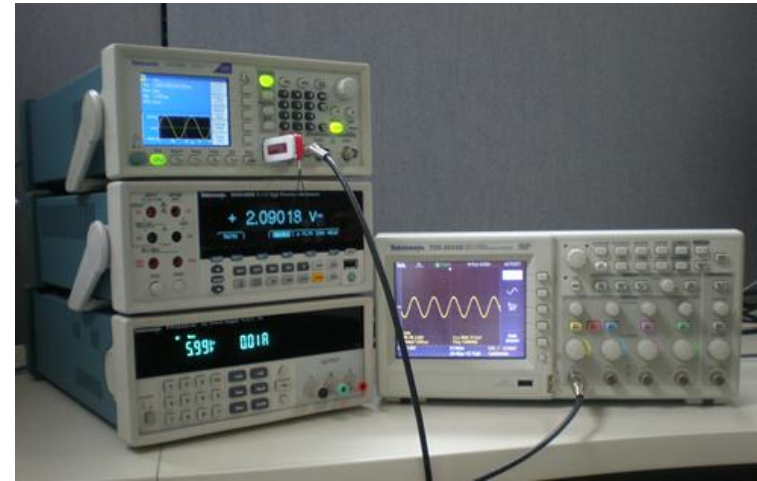

1018-004

# Ordering information

## ■ Base Model Pricing

Product	Description	US\$ Master Price
AFG2021	Arbitrary/Function Generator, 1-ch, 20MHz, 250MS/s, 14bit	\$1,590

## ■ Configuration Options

Option	Description	US\$ Master Price
GL	GPIB and LAN interfaces	\$100

## ■ Standard Accessories

Accessory
User Manual
Power Cord
USB Cable
CD-ROM with Programmer manual and service manual
CD-ROM with NI Labview Signal Express and IVI Drivers
CD-ROM with ArbExpress Software
NIST-Traceable Calibration Certificate

## ■ Recommended Accessories

Item	Description	US MSRP
RMU2U	Rackmount kit	\$152
013-0345-00	Fuse adapter, BNC-P to BNC-R	\$312
159-0454-00	Fuse set, 3 pcs, 0.125 A	\$21
012-0482-00	BNC cable shielded, 3 ft	\$206
012-1256-00	BNC cable shielded, 9 ft	\$84
012-0991-00	GPIB cable, double shielded	\$488
011-0049-02	50Ω BNC Terminator	\$135

# Options

## ■ Power Plug Options

Opt	Description	US MSRP
A0	North America	\$0
A1	Universal Euro	\$0
A2	United Kingdom	\$0
A3	Australia	\$0
A5	Switzerland	\$0
A6	Japan	\$0
A10	China	\$0
A11	India	\$0
A12	Brazil	\$0
A99	No power cord or adapter	\$0

## ■ Language Options

Opt	Description	US MSRP
L0	English manual	\$0
L1	French manual	\$0
L2	Italian manual	\$0
L3	German manual	\$0
L4	Spanish manual	\$0
L5	Japanese manual	\$0
L6	Portuguese manual	\$0
L7	Simple Chinese manual	\$0
L8	Traditional Chinese manual	\$0
L9	Korean manual	\$0
L10	Russian manual	\$0
L99	No Manual	\$0

## ■ Service Options

Opt	Description	US MSRP
C3	Calibration service 3 years	\$390
C5	Calibration service 5 years	\$738
D1	Calibration data report	\$65
D3	Calibration data report 3 years (with C3)	\$82
D5	Calibration data report 5 years (with C5)	\$163
R5	Repair service 5 years	\$260
R5DW	Repair Service Coverage 5 Years (starts at time of customer instrument purchase)	\$260

# Key Dates

Activity	Date
Order Queue Opens	▪ June 10, 2012
Shipments Begin	▪ July 03, 2012
Public Announcement *	▪ August 07, 2012

\* Product availability: target is 4 weeks.

# Demos & Training

- Demo Units
  - Distribution channel partners can opt to utilize the AFG2000 as demo for the entire AFG family
- Training
  - Level 1 CDT training and a demo guide will be developed as part of the product launch and will be made available through the Partner net



# Demand Generation and Marketing Collateral



Customer Presentation

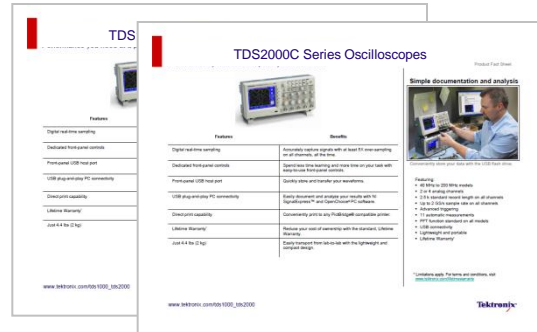

Product Fact Sheets



Product Material Q3



Web Content

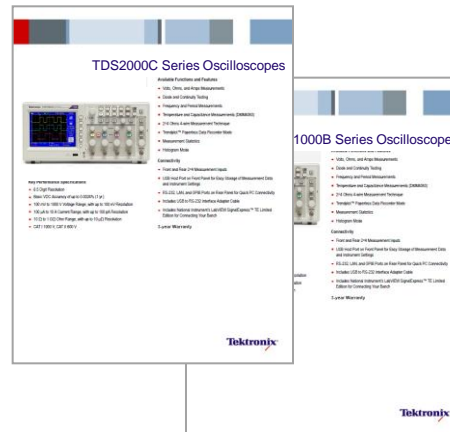

Product Datasheets



Application Notes Q3

# Front panel

On-line help in 8 languages

Save/recall settings to/from internal or USB memory

Rotary knob and key pad provide two ways to change numeric settings

Trigger Input / Output and Manual Trigger ease the effort for multi-instrument synchronization

USB Host on Front panel for waveform and setting save/recall

Floating output up to 42Vpk

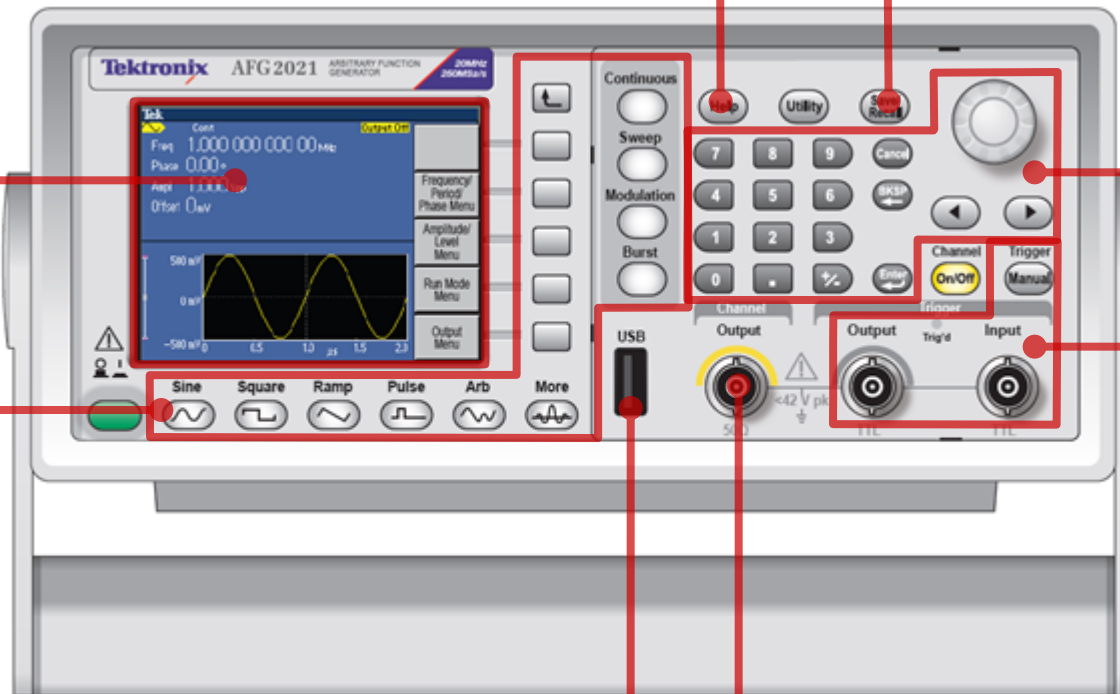

3.5" Color TFT LCD Displays waveform and settings in text and graphic

Shortcut buttons for easy access to frequently used functions and settings

# Rear panel

- Rear panel of base model



- Rear panel of model with GL option



External Modulating Signal Input      External Reference Clock Input

GPIB (optional)

USB Device (optional)      Ethernet LAN 10/100 M

Компания «Океан Электроники» предлагает заключение долгосрочных отношений при поставках импортных электронных компонентов на взаимовыгодных условиях!

Наши преимущества:

- Поставка оригинальных импортных электронных компонентов напрямую с производств Америки, Европы и Азии, а так же с крупнейших складов мира;
- Широкая линейка поставок активных и пассивных импортных электронных компонентов (более 30 млн. наименований);
- Поставка сложных, дефицитных, либо снятых с производства позиций;
- Оперативные сроки поставки под заказ (от 5 рабочих дней);
- Экспресс доставка в любую точку России;
- Помощь Конструкторского Отдела и консультации квалифицированных инженеров;
- Техническая поддержка проекта, помощь в подборе аналогов, поставка прототипов;
- Поставка электронных компонентов под контролем ВП;
- Система менеджмента качества сертифицирована по Международному стандарту ISO 9001;
- При необходимости вся продукция военного и аэрокосмического назначения проходит испытания и сертификацию в лаборатории (по согласованию с заказчиком);
- Поставка специализированных компонентов военного и аэрокосмического уровня качества (Xilinx, Altera, Analog Devices, Intersil, Interpoint, Microsemi, Actel, Aeroflex, Peregrine, VPT, Syfer, Eurofarad, Texas Instruments, MS Kennedy, Miteq, Cobham, E2V, MA-COM, Hittite, Mini-Circuits, General Dynamics и др.);

Компания «Океан Электроники» является официальным дистрибьютором и эксклюзивным представителем в России одного из крупнейших производителей разъемов военного и аэрокосмического назначения «JONHON», а так же официальным дистрибьютором и эксклюзивным представителем в России производителя высокотехнологичных и надежных решений для передачи СВЧ сигналов «FORSTAR».



## JONHON

«JONHON» (основан в 1970 г.)

Разъемы специального, военного и аэрокосмического назначения:

(Применяются в военной, авиационной, аэрокосмической, морской, железнодорожной, горно- и нефтедобывающей отраслях промышленности)

«FORSTAR» (основан в 1998 г.)

ВЧ соединители, коаксиальные кабели, кабельные сборки и микроволновые компоненты:

(Применяются в телекоммуникациях гражданского и специального назначения, в средствах связи, РЛС, а так же военной, авиационной и аэрокосмической отраслях промышленности).



Телефон: 8 (812) 309-75-97 (многоканальный)

Факс: 8 (812) 320-03-32

Электронная почта: [ocean@oceanchips.ru](mailto:ocean@oceanchips.ru)

Web: <http://oceanchips.ru/>

Адрес: 198099, г. Санкт-Петербург, ул. Калинина, д. 2, корп. 4, лит. А