

Schottky Rectifier, 100 A

ADD-A-PAK

PRODUCT SUMMARY

$I_{F(AV)}$	100 A
-------------	-------

MECHANICAL DESCRIPTION

The Generation 5 of ADD-A-PAK module combine the excellent thermal performance obtained by the usage of direct bonded copper substrate with superior mechanical ruggedness, thanks to the insertion of a solid copper baseplate at the bottom side of the device.

The Cu baseplate allow an easier mounting on the majority of heatsink with increased tolerance of surface roughness and improved thermal spread.

The Generation 5 of ADD-A-PAK module is manufactured without hard mold, eliminating in this way any possible direct stress on the leads.

The electrical terminals are secured against axial pull-out: they are fixed to the module housing via a click-stop feature already tested and proved as reliable on other Vishay HPP modules.

FEATURES

- 150 °C T_J operation
- Low forward voltage drop
- High frequency operation
- Guard ring for enhanced ruggedness and long term reliability
- UL pending
- Totally lead (Pb)-free, RoHS compliant
- Designed and qualified for industrial level

RoHS
COMPLIANT

DESCRIPTION

The VSKDS208.. Schottky rectifier doubler module has been optimized for low reverse leakage at high temperature. The proprietary barrier technology allows for reliable operation up to 150 °C junction temperature.

Typical applications are in high current switching power supplies, plating power supplies, UPS systems, converters, freewheeling diodes, welding, and reverse battery protection.

MAJOR RATINGS AND CHARACTERISTICS

SYMBOL	CHARACTERISTICS	VALUES	UNITS
$I_{F(AV)}$	Rectangular waveform	100	A
V_{RRM}		60	V
I_{FSM}	$t_p = 5 \mu s$ sine	15 000	A
V_F	100 Apk, $T_J = 125 \text{ }^\circ\text{C}$	0.64	V
T_J	Range	- 55 to 150	$^\circ\text{C}$

VOLTAGE RATINGS

PARAMETER	SYMBOL	VSKDS208/060P	UNITS
Maximum DC reverse voltage	V_R	60	V
Maximum working peak reverse voltage	V_{RWM}		

ABSOLUTE MAXIMUM RATINGS					
PARAMETER	SYMBOL	TEST CONDITIONS		VALUES	UNITS
Maximum average forward current	$I_{F(AV)}$	50 % duty cycle at $T_C = 97\text{ }^\circ\text{C}$, rectangular waveform		100	
Maximum peak one cycle non-repetitive surge current	I_{FSM}	5 μs sine or 3 μs rect. pulse	Following any rated load condition and with rated V_{RRM} applied	15 000	A
		10 ms sine or 6 ms rect. pulse		1900	
Non-repetitive avalanche energy	E_{AS}	$T_J = 25\text{ }^\circ\text{C}$, $I_{AS} = 5.5\text{ Amps}$, $L = 1\text{ mH}$		15	mJ
Repetitive avalanche current	I_{AR}	Current decaying linearly to zero in 1 μs Frequency limited by T_J maximum $V_A = 1.5 \times V_R$ typical		1	A

ELECTRICAL SPECIFICATIONS					
PARAMETER	SYMBOL	TEST CONDITIONS		VALUES	UNITS
Maximum forward voltage drop	$V_{FM}^{(1)}$	200 A	$T_J = 25\text{ }^\circ\text{C}$	0.69	V
		400 A		0.97	
		200 A	$T_J = 125\text{ }^\circ\text{C}$	0.64	
		400 A		0.89	
Maximum reverse leakage current	$I_{RM}^{(1)}$	$T_J = 25\text{ }^\circ\text{C}$	$V_R = \text{Rated } V_R$	1.1	mA
		$T_J = 125\text{ }^\circ\text{C}$		300	
Maximum junction capacitance	C_T	$V_R = 5 V_{DC}$ (test signal range 100 kHz to 1 MHz) $25\text{ }^\circ\text{C}$		6000	pF
Typical series inductance	L_S	From top of terminal hole to mounting plane		5.0	nH
Maximum voltage rate of change	dV/dt	Rated V_R		10 000	V/ μs
RMS insulation voltage	V_{INS}	50 Hz, circuit to base, all terminals shorted (1 s)		3500	V

Note⁽¹⁾ Pulse width < 500 μs

THERMAL - MECHANICAL SPECIFICATIONS					
PARAMETER	SYMBOL	TEST CONDITIONS		VALUES	UNITS
Maximum junction and storage temperature range	T_J, T_{Stg}			- 55 to 150	$^\circ\text{C}$
Maximum thermal resistance, junction to case per leg	R_{thJC}	DC operation		0.6	$^\circ\text{C/W}$
Maximum thermal resistance, case to heatsink	R_{thCS}	Mounting surface, smooth and greased		0.1	
Approximate weight				110	g
				4	oz.
Mounting torque $\pm 10\%$	to heatsink			5	Nm
	busbar			4	
Case style		JEDEC		TO-240AA	

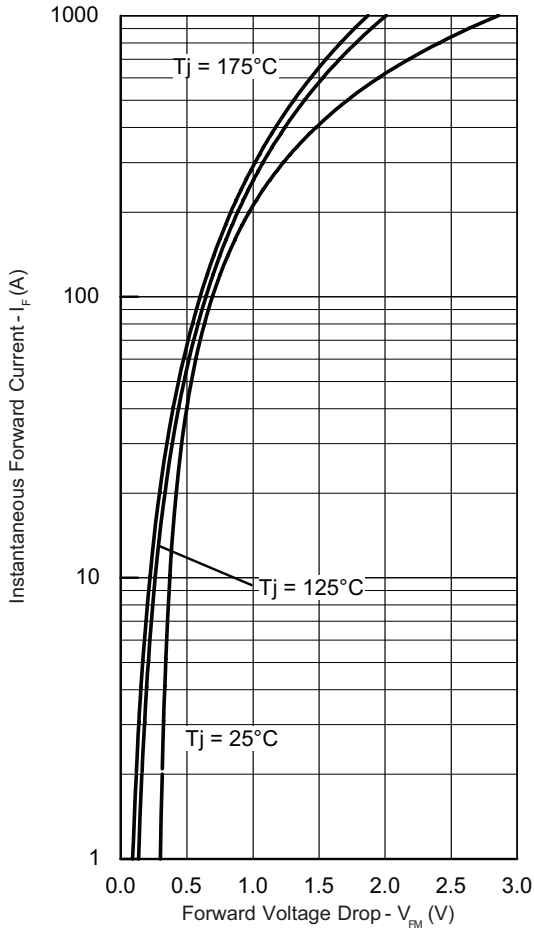

Fig. 1 - Maximum Forward Voltage Drop Characteristics

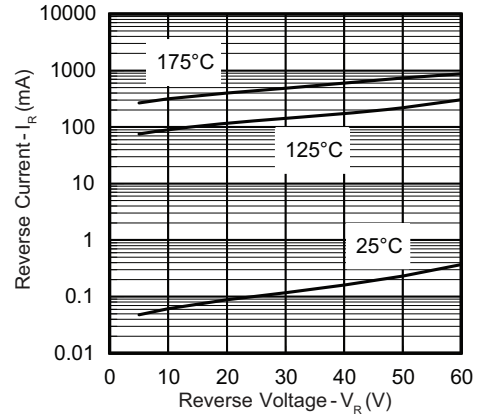

Fig. 2 - Typical Values of Reverse Current vs. Reverse Voltage

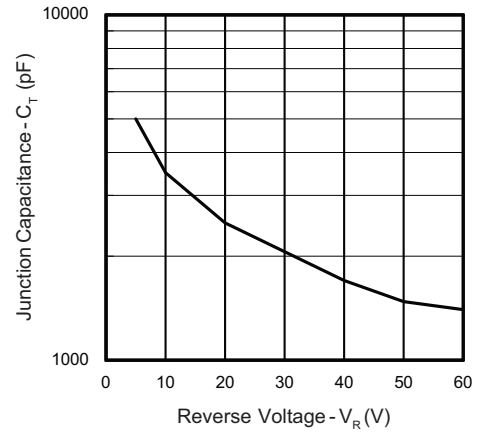
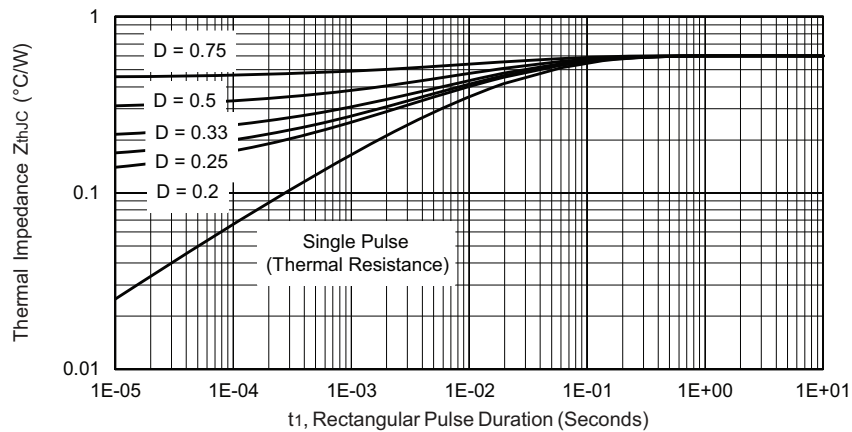

Fig. 3 - Typical Junction Capacitance vs. Reverse Voltage

 Fig. 4 - Maximum Thermal Impedance Z_{thJC} Characteristics

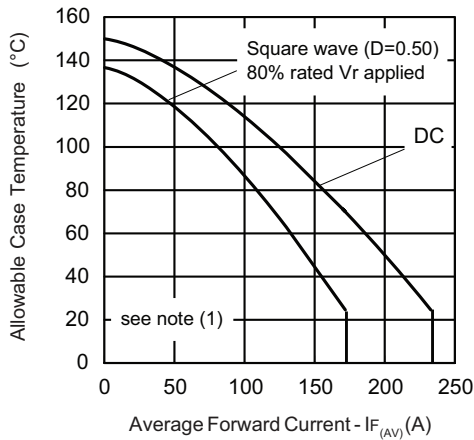

Fig. 5 - Maximum Allowable Case Temperature vs. Average Forward Current

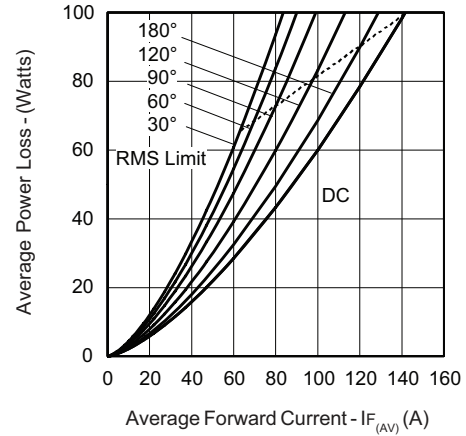

Fig. 6 - Forward Power Loss Characteristics

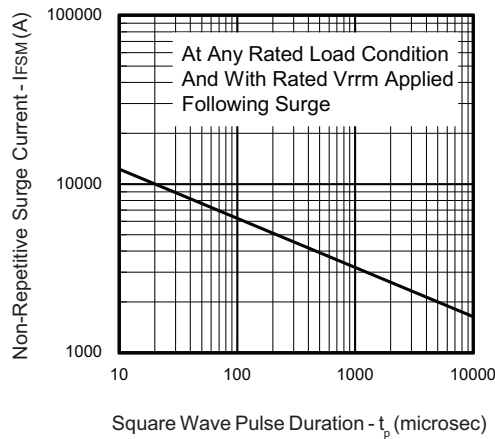

Fig. 7 - Maximum Non-Repetitive Surge Current



Fig. 8 - Unclamped Inductive Test Circuit

Note

- (1) Formula used: $T_C = T_J - (P_d + P_{d_{REV}}) \times R_{thJC}$;
 P_d = Forward power loss = $I_{F(AV)} \times V_{FM}$ at $(I_{F(AV)}/D)$ (see fig. 6);
 $P_{d_{REV}}$ = Inverse power loss = $V_{R1} \times I_R (1 - D)$; I_R at $V_{R1} = 80\%$ rated V_R



ORDERING INFORMATION TABLE

Device code	VS	KD	S	20	8	/	060	P
	①	②	③	④	⑤		⑥	⑦

- 1** - Vishay HPP
- 2** - Circuit configuration:
KD = ADD-A-PAK - 2 diodes in series
- 3** - S = Schottky diode
- 4** - Average rating (x 10)
- 5** - Product silicon identification
- 6** - Voltage rating (060 = 60 V)
- 7** - Lead (Pb)-free

CIRCUIT CONFIGURATION

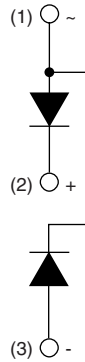

LINKS TO RELATED DOCUMENTS	
Dimensions	http://www.vishay.com/doc?95174

ADD-A-PAK Diode

DIMENSIONS in millimeters (inches)

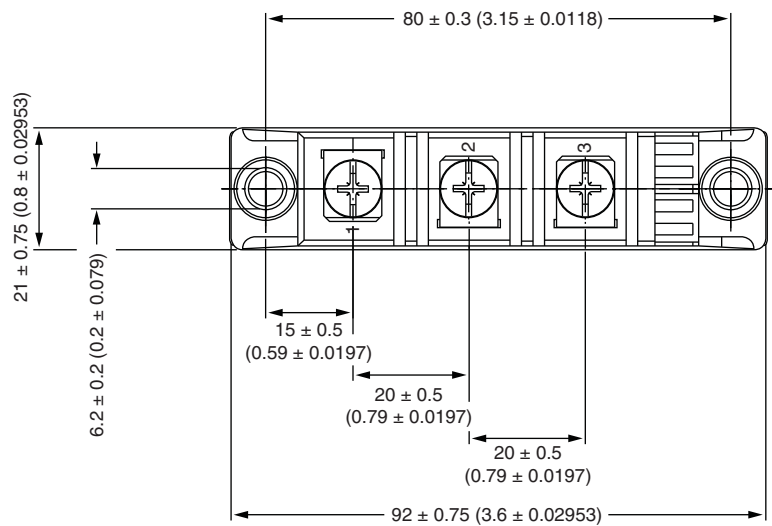
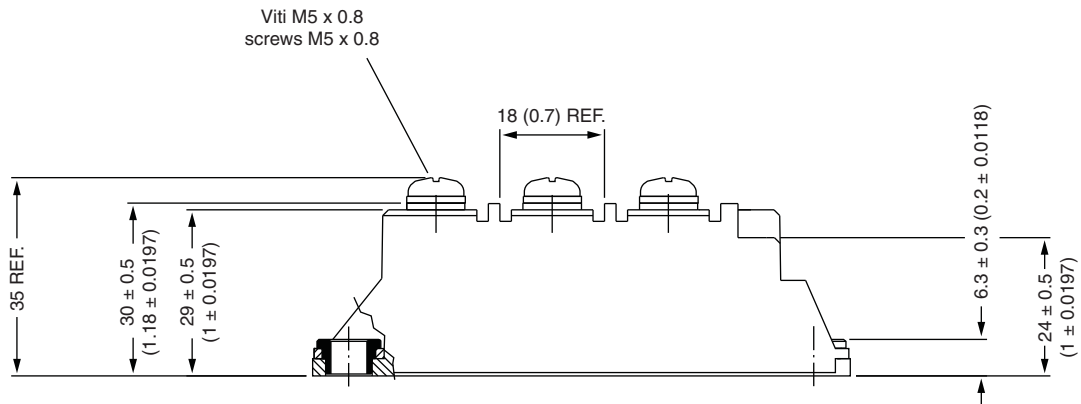



Disclaimer

ALL PRODUCT, PRODUCT SPECIFICATIONS AND DATA ARE SUBJECT TO CHANGE WITHOUT NOTICE TO IMPROVE RELIABILITY, FUNCTION OR DESIGN OR OTHERWISE.

Vishay Intertechnology, Inc., its affiliates, agents, and employees, and all persons acting on its or their behalf (collectively, "Vishay"), disclaim any and all liability for any errors, inaccuracies or incompleteness contained in any datasheet or in any other disclosure relating to any product.

Vishay makes no warranty, representation or guarantee regarding the suitability of the products for any particular purpose or the continuing production of any product. To the maximum extent permitted by applicable law, Vishay disclaims (i) any and all liability arising out of the application or use of any product, (ii) any and all liability, including without limitation special, consequential or incidental damages, and (iii) any and all implied warranties, including warranties of fitness for particular purpose, non-infringement and merchantability.

Statements regarding the suitability of products for certain types of applications are based on Vishay's knowledge of typical requirements that are often placed on Vishay products in generic applications. Such statements are not binding statements about the suitability of products for a particular application. It is the customer's responsibility to validate that a particular product with the properties described in the product specification is suitable for use in a particular application. Parameters provided in datasheets and/or specifications may vary in different applications and performance may vary over time. All operating parameters, including typical parameters, must be validated for each customer application by the customer's technical experts. Product specifications do not expand or otherwise modify Vishay's terms and conditions of purchase, including but not limited to the warranty expressed therein.

Except as expressly indicated in writing, Vishay products are not designed for use in medical, life-saving, or life-sustaining applications or for any other application in which the failure of the Vishay product could result in personal injury or death. Customers using or selling Vishay products not expressly indicated for use in such applications do so at their own risk and agree to fully indemnify and hold Vishay and its distributors harmless from and against any and all claims, liabilities, expenses and damages arising or resulting in connection with such use or sale, including attorneys fees, even if such claim alleges that Vishay or its distributor was negligent regarding the design or manufacture of the part. Please contact authorized Vishay personnel to obtain written terms and conditions regarding products designed for such applications.

No license, express or implied, by estoppel or otherwise, to any intellectual property rights is granted by this document or by any conduct of Vishay. Product names and markings noted herein may be trademarks of their respective owners.

Компания «Океан Электроники» предлагает заключение долгосрочных отношений при поставках импортных электронных компонентов на взаимовыгодных условиях!

Наши преимущества:

- Поставка оригинальных импортных электронных компонентов напрямую с производств Америки, Европы и Азии, а так же с крупнейших складов мира;
- Широкая линейка поставок активных и пассивных импортных электронных компонентов (более 30 млн. наименований);
- Поставка сложных, дефицитных, либо снятых с производства позиций;
- Оперативные сроки поставки под заказ (от 5 рабочих дней);
- Экспресс доставка в любую точку России;
- Помощь Конструкторского Отдела и консультации квалифицированных инженеров;
- Техническая поддержка проекта, помощь в подборе аналогов, поставка прототипов;
- Поставка электронных компонентов под контролем ВП;
- Система менеджмента качества сертифицирована по Международному стандарту ISO 9001;
- При необходимости вся продукция военного и аэрокосмического назначения проходит испытания и сертификацию в лаборатории (по согласованию с заказчиком);
- Поставка специализированных компонентов военного и аэрокосмического уровня качества (Xilinx, Altera, Analog Devices, Intersil, Interpoint, Microsemi, Actel, Aeroflex, Peregrine, VPT, Syfer, Eurofarad, Texas Instruments, MS Kennedy, Miteq, Cobham, E2V, MA-COM, Hittite, Mini-Circuits, General Dynamics и др.);

Компания «Океан Электроники» является официальным дистрибьютором и эксклюзивным представителем в России одного из крупнейших производителей разъемов военного и аэрокосмического назначения «JONHON», а так же официальным дистрибьютором и эксклюзивным представителем в России производителя высокотехнологичных и надежных решений для передачи СВЧ сигналов «FORSTAR».



JONHON

«JONHON» (основан в 1970 г.)

Разъемы специального, военного и аэрокосмического назначения:

(Применяются в военной, авиационной, аэрокосмической, морской, железнодорожной, горно- и нефтедобывающей отраслях промышленности)

«FORSTAR» (основан в 1998 г.)

ВЧ соединители, коаксиальные кабели, кабельные сборки и микроволновые компоненты:

(Применяются в телекоммуникациях гражданского и специального назначения, в средствах связи, РЛС, а так же военной, авиационной и аэрокосмической отраслях промышленности).



Телефон: 8 (812) 309-75-97 (многоканальный)

Факс: 8 (812) 320-03-32

Электронная почта: ocean@oceanchips.ru

Web: <http://oceanchips.ru/>

Адрес: 198099, г. Санкт-Петербург, ул. Калинина, д. 2, корп. 4, лит. А