

0.25 dB LSB GaAs MMIC 5-BIT DIGITAL POSITIVE CONTROL ATTENUATOR, DC - 4 GHz

Typical Applications

The HMC539ALP3/539ALP3E is ideal for both RF and IF applications:

- Cellular Infrastructure
- ISM, MMDS, WLAN, WiMAX, WiBro
- Microwave Radio & VSAT
- Test Equipment and Sensors

Functional Diagram

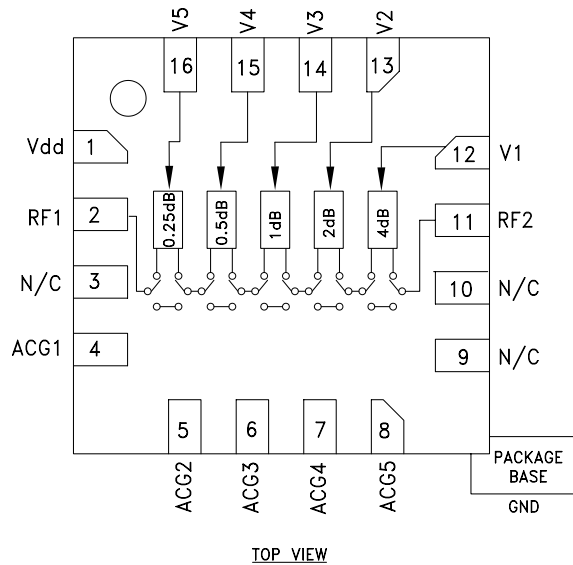

Features

- 0.25 dB LSB Steps to 7.75 dB
- ± 0.05 dB Typical Step Error
- Low Insertion Loss: 0.7 dB
- High IP3: +62 dBm
- Single Control Line Per Bit
- TTL/CMOS Compatible Control
- Single +3V to +5V Supply
- 3x3 mm SMT Package

General Description

The HMC539ALP3/539ALP3E is a broadband 5-bit GaAs IC digital attenuator in a low cost leadless surface mount package. This single positive control line per bit digital attenuator utilizes an off chip AC ground capacitor for near DC operation, making it suitable for a wide variety of RF and IF applications. Covering DC to 4 GHz, the insertion loss is less than 0.7 dB typical. The attenuator bit values are 0.25 (LSB), 0.5, 1, 2, and 4 dB for a total attenuation of 7.75 dB. Attenuation accuracy is excellent at ± 0.05 dB typical step error. The attenuator also features a high IIP3 of +62 dBm. Five TTL/CMOS control inputs are used to select each attenuation state. A single Vdd bias of +3V to +5V is required.

Electrical Specifications,

$T_A = +25^\circ \text{C}$, With $V_{dd} = +5V$ & $V_{ctl} = 0/+5V$ (Unless Otherwise Noted)

Parameter	Frequency (GHz)	Min.	Typ.	Max.	Units
Insertion Loss	DC - 1.5 GHz		0.7	1.0	dB
	1.5 - 3.0 GHz		1.0	1.3	dB
	3.0 - 4.0 GHz		1.3	1.7	dB
Attenuation Range	DC - 4 GHz		7.75		dB
Return Loss (RF1 & RF2, All Atten. States)	DC - 3 GHz		27		dB
	3.0 - 4.0 GHz		25		dB
Attenuation Accuracy: (Referenced to Insertion Loss)	All States DC - 3 GHz 3.0 - 4.0 GHz	± (0.2 + 2% of Atten. Setting) Max.			dB
		± (0.2 + 4% of Atten. Setting) Max.			dB
Input Power for 0.1 dB Compression	0.1 - 4.0 GHz		32		dBm
Input Third Order Intercept Point (Two-Tone Input Power= 15 dBm Each Tone)	0.1 - 4.0 GHz		62		dBm
Switching Characteristics	DC - 4 GHz				
		tRISE, tFALL (10/90% RF)		45	ns
		tON, tOFF (50% CTL to 10/90% RF)		52	ns

0.25 dB LSB GaAs MMIC 5-BIT DIGITAL POSITIVE CONTROL ATTENUATOR, DC - 4 GHz

Insertion Loss

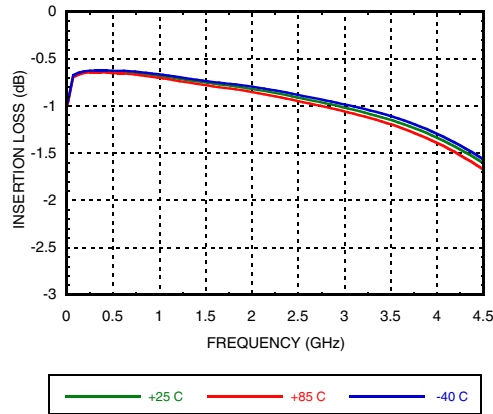

Return Loss RF1, RF2
(Only Major States are Shown)

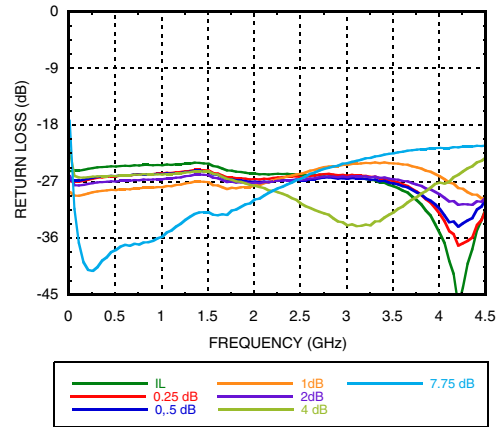

Normalized Attenuation
(Only Major States are Shown)

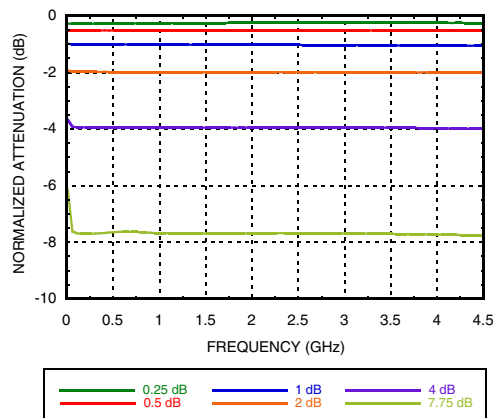

Bit Error vs. Attenuation State

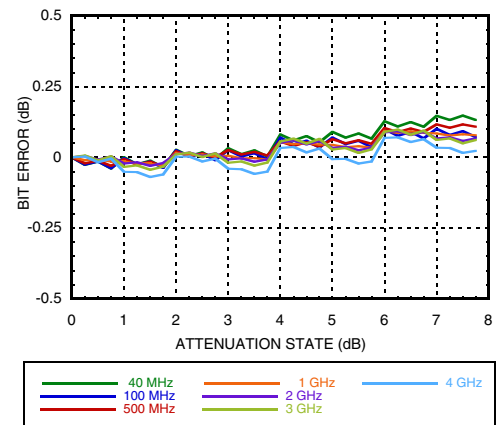

Bit Error vs. Frequency
(Only Major States are Shown)

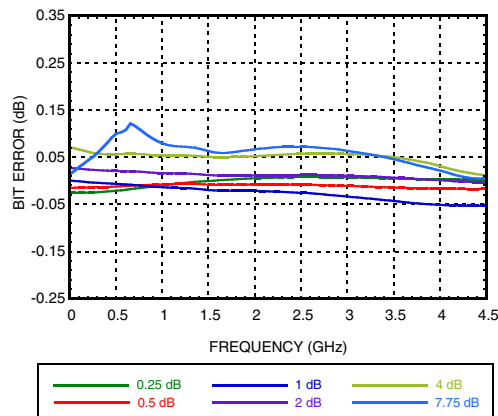

Relative Phase vs. Frequency
(Only Major States are Shown)

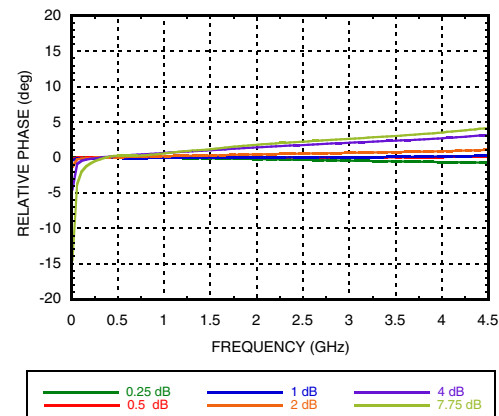

0.25 dB LSB GaAs MMIC 5-BIT DIGITAL POSITIVE CONTROL ATTENUATOR, DC - 4 GHz

Step Error vs. Frequency (Only Major States are Shown)

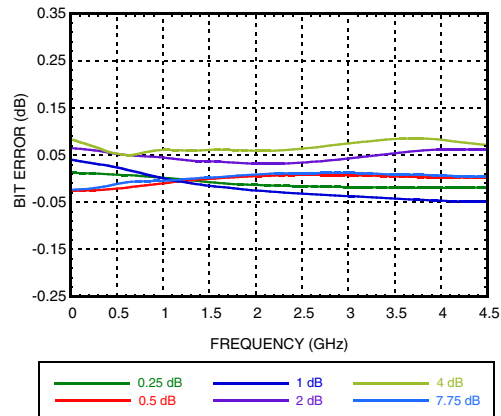

1dB Input Compression Point

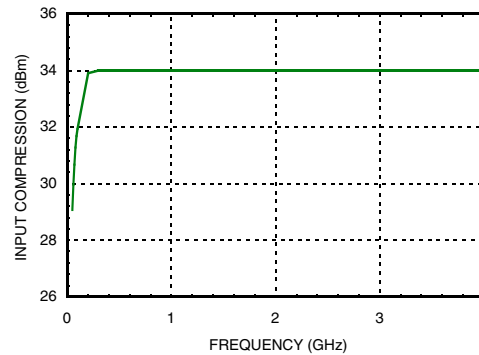

Bias Voltage & Current

Vdd = +5.0 Vdc ± 10%	
Vdd (VDC)	Idd (Typ.) (mA)
+3.0	1.6
+5.0	1.7

Truth Table

Control Voltage Input					Attenuation State RF1 - RF2
V1 4 dB	V2 2 dB	V3 1 dB	V4 0.5 dB	V5 0.25 dB	
High	High	High	High	High	Reference I.L.
High	High	High	High	Low	0.25 dB
High	High	High	Low	High	0.5 dB
High	High	Low	High	High	1 dB
High	Low	High	High	High	2 dB
Low	High	High	High	High	4 dB
Low	Low	Low	Low	Low	7.75 dB

Any combination of the above states will provide an attenuation approximately equal to the sum of the bits selected.

Control Voltage

State	Vdd = +3V	Vdd = +5V
Low	0 to 0.8V @ <1 uA	0 to +1.1V @ 33uA Typ.
High	1.2 to 3.3V @ <1 uA	1.8V to +5.0V @ 33uA Typ.

0.25 dB LSB GaAs MMIC 5-BIT DIGITAL POSITIVE CONTROL ATTENUATOR, DC - 4 GHz

Absolute Maximum Ratings

RF Input Power (DC - 4 GHz)	+29 dBm (T = +85 °C)
Control Voltage Range (V1 to V5)	-1V to Vdd +1V
Bias Voltage (Vdd)	+7.0 Vdc
Channel Temperature	150 °C
Continuous Pdiss (T = 85 °C) (derate 12.0 mW/°C above 85 °C)	0.551 W
Thermal Resistance	118 °C/W
Storage Temperature	-65 to +150 °C
Operating Temperature	-40 to +85 °C



ELECTROSTATIC SENSITIVE DEVICE
OBSERVE HANDLING PRECAUTIONS

Outline Drawing

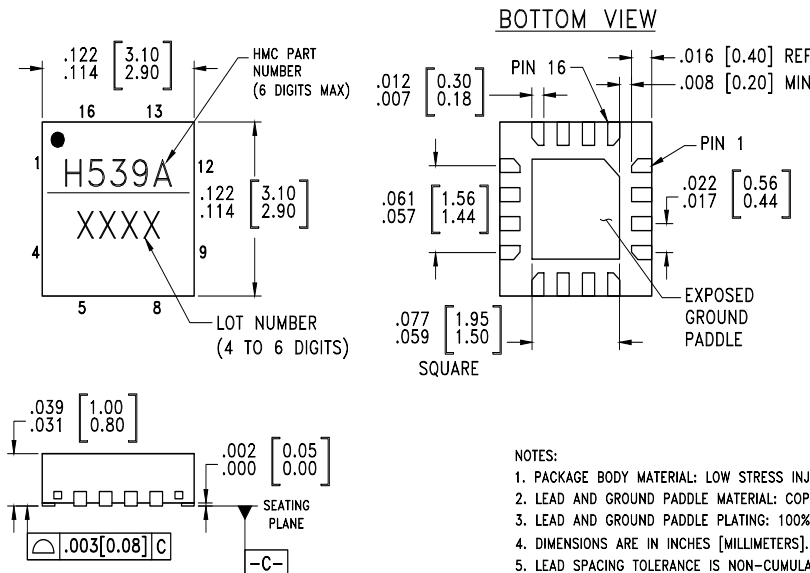

Package Information

Part Number	Package Body Material	Lead Finish	MSL Rating	Package Marking ^[3]
HMC539ALP3	Low Stress Injection Molded Plastic	Sn/Pb solder	MSL3 ^[1]	H539A XXXX
HMC539ALP3E	RoHS-compliant Low Stress Injection Molded Plastic	100% matte Sn	MSL3 ^[2]	H539A XXXX

[1] Max peak reflow temperature of 235 °C

[2] Max peak reflow temperature of 260 °C

[3] 4-Digit lot number XXXX

0.25 dB LSB GaAs MMIC 5-BIT DIGITAL POSITIVE CONTROL ATTENUATOR, DC - 4 GHz

Pin Descriptions

Pin Number	Function	Description	Interface Schematic
1	Vdd	Supply Voltage.	
2, 11	RF1, RF2	This pin is DC coupled and matched to 50 Ohm. Blocking capacitors are required. Select value based on lowest frequency of operation.	
3, 9, 10	N/C	These pins should be connected to PCB RF ground to maximize performance.	
4 - 8	ACG1 - ACG5	External capacitor to ground is required. Select value for lowest frequency of operation. Place capacitor as close to pins as possible.	
12 - 16	V1 - V5	See truth table and control voltage table.	
	GND	Package bottom has an exposed metal paddle that must be connected to RF Ground.	

Application Circuit

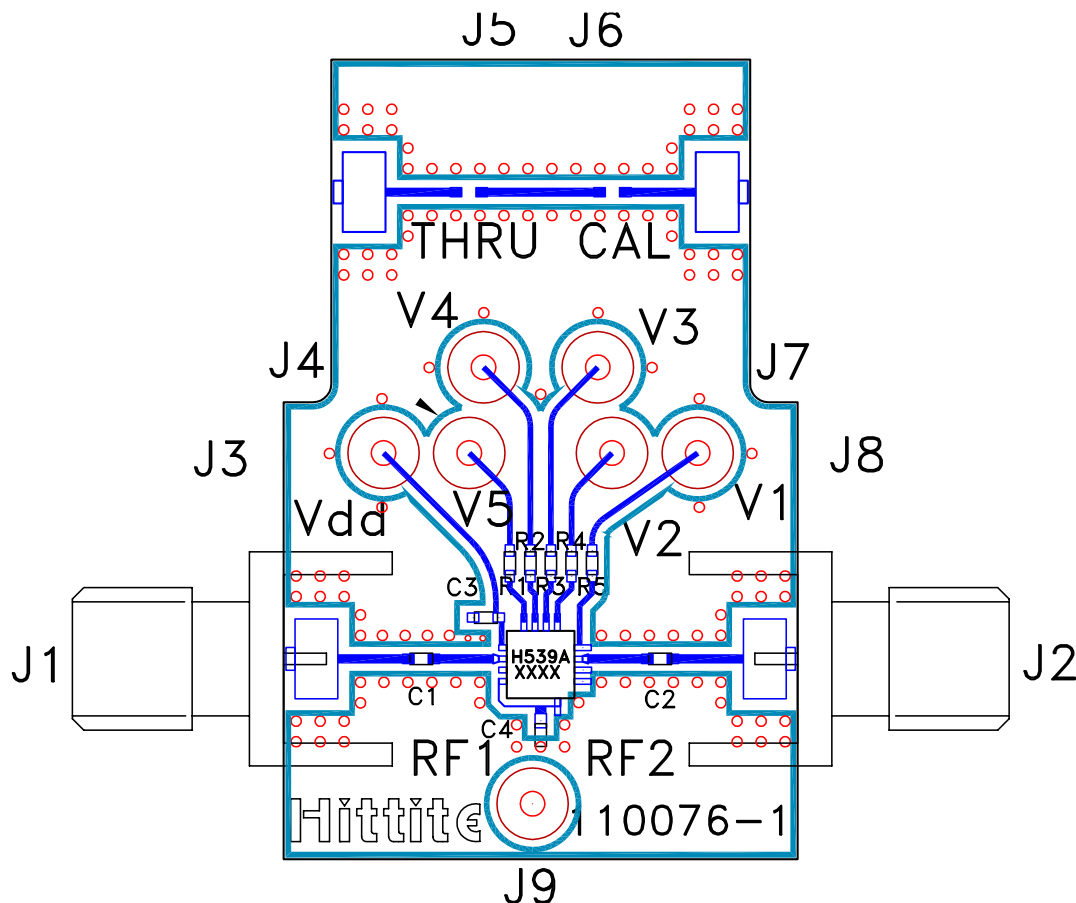

**0.25 dB LSB GaAs MMIC 5-BIT DIGITAL
POSITIVE CONTROL ATTENUATOR, DC - 4 GHz**
Evaluation PCB

List of Materials for Evaluation PCB EV1HC539ALP3 [1]

Item	Description
J1, J2	PCB Mount SMA Connector
J3 - J9	DC Pin
C1, C2	100 pF Capacitor, 0402 Pkg.
C3	1000 pF Capacitor, 0402 Pkg.
C4	330 pF Capacitor, 0402 Pkg.
R1 - R5	100 Ohm Resistor 0402
U1	HMC539ALP3/539ALP3E Digital Attenuator
PCB [2]	110076 Evaluation PCB

[1] Reference this number when ordering complete evaluation PCB

[2] Circuit Board Material: Rogers 4350

The circuit board used in the application should use RF circuit design techniques. Signal lines should have 50 Ohm impedance while the package ground leads and exposed paddle should be connected directly to the ground plane similar to that shown. A sufficient number of via holes should be used to connect the top and bottom ground planes. The evaluation circuit board shown is available from Analog Devices Inc upon request.

Компания «Океан Электроники» предлагает заключение долгосрочных отношений при поставках импортных электронных компонентов на взаимовыгодных условиях!

Наши преимущества:

- Поставка оригинальных импортных электронных компонентов напрямую с производств Америки, Европы и Азии, а так же с крупнейших складов мира;
- Широкая линейка поставок активных и пассивных импортных электронных компонентов (более 30 млн. наименований);
- Поставка сложных, дефицитных, либо снятых с производства позиций;
- Оперативные сроки поставки под заказ (от 5 рабочих дней);
- Экспресс доставка в любую точку России;
- Помощь Конструкторского Отдела и консультации квалифицированных инженеров;
- Техническая поддержка проекта, помощь в подборе аналогов, поставка прототипов;
- Поставка электронных компонентов под контролем ВП;
- Система менеджмента качества сертифицирована по Международному стандарту ISO 9001;
- При необходимости вся продукция военного и аэрокосмического назначения проходит испытания и сертификацию в лаборатории (по согласованию с заказчиком);
- Поставка специализированных компонентов военного и аэрокосмического уровня качества (Xilinx, Altera, Analog Devices, Intersil, Interpoint, Microsemi, Actel, Aeroflex, Peregrine, VPT, Syfer, Eurofarad, Texas Instruments, MS Kennedy, Miteq, Cobham, E2V, MA-COM, Hittite, Mini-Circuits, General Dynamics и др.);

Компания «Океан Электроники» является официальным дистрибьютором и эксклюзивным представителем в России одного из крупнейших производителей разъемов военного и аэрокосмического назначения «JONHON», а так же официальным дистрибьютором и эксклюзивным представителем в России производителя высокотехнологичных и надежных решений для передачи СВЧ сигналов «FORSTAR».



JONHON

«JONHON» (основан в 1970 г.)

Разъемы специального, военного и аэрокосмического назначения:

(Применяются в военной, авиационной, аэрокосмической, морской, железнодорожной, горно- и нефтедобывающей отраслях промышленности)

«FORSTAR» (основан в 1998 г.)

ВЧ соединители, коаксиальные кабели, кабельные сборки и микроволновые компоненты:

(Применяются в телекоммуникациях гражданского и специального назначения, в средствах связи, РЛС, а так же военной, авиационной и аэрокосмической отраслях промышленности).



Телефон: 8 (812) 309-75-97 (многоканальный)

Факс: 8 (812) 320-03-32

Электронная почта: ocean@oceanchips.ru

Web: <http://oceanchips.ru/>

Адрес: 198099, г. Санкт-Петербург, ул. Калинина, д. 2, корп. 4, лит. А