



Is Now Part of



ON Semiconductor®

To learn more about ON Semiconductor, please visit our website at
www.onsemi.com

Please note: As part of the Fairchild Semiconductor integration, some of the Fairchild orderable part numbers will need to change in order to meet ON Semiconductor's system requirements. Since the ON Semiconductor product management systems do not have the ability to manage part nomenclature that utilizes an underscore (_), the underscore (_) in the Fairchild part numbers will be changed to a dash (-). This document may contain device numbers with an underscore (_). Please check the ON Semiconductor website to verify the updated device numbers. The most current and up-to-date ordering information can be found at www.onsemi.com. Please email any questions regarding the system integration to Fairchild_questions@onsemi.com.

ON Semiconductor and the ON Semiconductor logo are trademarks of Semiconductor Components Industries, LLC dba ON Semiconductor or its subsidiaries in the United States and/or other countries. ON Semiconductor owns the rights to a number of patents, trademarks, copyrights, trade secrets, and other intellectual property. A listing of ON Semiconductor's product/patent coverage may be accessed at www.onsemi.com/site/pdf/Patent-Marking.pdf. ON Semiconductor reserves the right to make changes without further notice to any products herein. ON Semiconductor makes no warranty, representation or guarantee regarding the suitability of its products for any particular purpose, nor does ON Semiconductor assume any liability arising out of the application or use of any product or circuit, and specifically disclaims any and all liability, including without limitation special, consequential or incidental damages. Buyer is responsible for its products and applications using ON Semiconductor products, including compliance with all laws, regulations and safety requirements or standards, regardless of any support or applications information provided by ON Semiconductor. "Typical" parameters which may be provided in ON Semiconductor data sheets and/or specifications can and do vary in different applications and actual performance may vary over time. All operating parameters, including "Typicals" must be validated for each customer application by customer's technical experts. ON Semiconductor does not convey any license under its patent rights nor the rights of others. ON Semiconductor products are not designed, intended, or authorized for use as a critical component in life support systems or any FDA Class 3 medical devices or medical devices with a same or similar classification in a foreign jurisdiction or any devices intended for implantation in the human body. Should Buyer purchase or use ON Semiconductor products for any such unintended or unauthorized application, Buyer shall indemnify and hold ON Semiconductor and its officers, employees, subsidiaries, affiliates, and distributors harmless against all claims, costs, damages, and expenses, and reasonable attorney fees arising out of, directly or indirectly, any claim of personal injury or death associated with such unintended or unauthorized use, even if such claim alleges that ON Semiconductor was negligent regarding the design or manufacture of the part. ON Semiconductor is an Equal Opportunity/Affirmative Action Employer. This literature is subject to all applicable copyright laws and is not for resale in any manner.



March 2015



FGA60N60UFD 600 V, 60 A Field Stop IGBT

Features

- High Current Capability
- Low Saturation Voltage: $V_{CE(sat)} = 1.9\text{ V @ } I_C = 60\text{ A}$
- High Input Impedance
- Fast Switching
- RoHS Compliant

Applications

- Solar Inverter, UPS, Welder, PFC

General Description

Using novel field stop IGBT technology, Fairchild's field stop IGBTs offer the optimum performance for solar inverter, UPS, welder and PFC applications where low conduction and switching losses are essential.

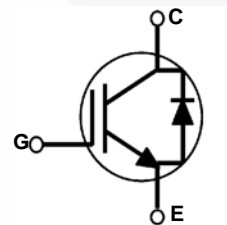
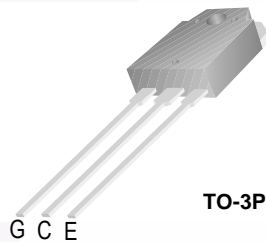

Absolute Maximum Ratings

| Symbol | Description | Ratings | Unit |
|-------------|---|-------------|------------------|
| V_{CES} | Collector to Emitter Voltage | 600 | V |
| V_{GES} | Gate to Emitter Voltage | ± 20 | V |
| | Transient Gate-to-Emitter Voltage | ± 30 | |
| I_C | Collector Current @ $T_C = 25^\circ\text{C}$ | 120 | A |
| | Collector Current @ $T_C = 100^\circ\text{C}$ | 60 | A |
| $I_{CM(1)}$ | Pulsed Collector Current @ $T_C = 25^\circ\text{C}$ | 180 | A |
| P_D | Maximum Power Dissipation @ $T_C = 25^\circ\text{C}$ | 298 | W |
| | Maximum Power Dissipation @ $T_C = 100^\circ\text{C}$ | 119 | W |
| T_J | Operating Junction Temperature | -55 to +150 | $^\circ\text{C}$ |
| T_{stg} | Storage Temperature Range | -55 to +150 | $^\circ\text{C}$ |
| T_L | Maximum Lead Temp. for soldering Purposes, 1/8" from case for 5 seconds | 300 | $^\circ\text{C}$ |

Notes:

1: Repetitive test, Pulse width limited by max. junction temperature

Thermal Characteristics

| Symbol | Parameter | Typ. | Max. | Unit |
|-------------------------------|---|------|------|--------------------|
| $R_{\theta JC}(\text{IGBT})$ | Thermal Resistance, Junction to Case | - | 0.33 | $^\circ\text{C/W}$ |
| $R_{\theta JC}(\text{Diode})$ | Thermal Resistance, Junction to Case | - | 1.1 | $^\circ\text{C/W}$ |
| $R_{\theta JA}$ | Thermal Resistance, Junction to Ambient | - | 40 | $^\circ\text{C/W}$ |

Package Marking and Ordering Information

| Part Number | Top Mark | Package | Packing Method | Reel Size | Tape Width | Quantity |
|-------------|-------------|---------|----------------|-----------|------------|----------|
| FGA60N60UFD | FGA60N60UFD | TO-3P | Tube | N/A | N/A | 30 |

Electrical Characteristics of the IGBT T_C = 25°C unless otherwise noted

| Symbol | Parameter | Test Conditions | Min. | Typ. | Max. | Unit |
|--------------------------------------|--|--|------|------|------|------|
| Off Characteristics | | | | | | |
| BV _{CES} | Collector to Emitter Breakdown Voltage | V _{GE} = 0 V, I _C = 250 μA | 600 | - | - | V |
| ΔBV _{CES} / ΔT _J | Temperature Coefficient of Breakdown Voltage | V _{GE} = 0 V, I _C = 250 μA | - | 0.67 | - | V/°C |
| I _{CES} | Collector Cut-Off Current | V _{CE} = V _{CES} , V _{GE} = 0 V | - | - | 250 | μA |
| I _{GES} | G-E Leakage Current | V _{GE} = V _{GES} , V _{CE} = 0 V | - | - | ±400 | nA |
| On Characteristics | | | | | | |
| V _{GE(th)} | G-E Threshold Voltage | I _C = 250 μA, V _{CE} = V _{GE} | 4.0 | 5.0 | 6.5 | V |
| V _{CE(sat)} | Collector to Emitter Saturation Voltage | I _C = 60 A, V _{GE} = 15 V | - | 1.9 | 2.4 | V |
| | | I _C = 60 A, V _{GE} = 15 V, T _C = 125°C | - | 2.1 | - | V |
| Dynamic Characteristics | | | | | | |
| C _{ies} | Input Capacitance | V _{CE} = 30 V, V _{GE} = 0 V, f = 1 MHz | - | 2855 | - | pF |
| C _{oes} | Output Capacitance | | - | 325 | - | pF |
| C _{res} | Reverse Transfer Capacitance | | - | 110 | - | pF |
| Switching Characteristics | | | | | | |
| t _{d(on)} | Turn-On Delay Time | V _{CC} = 400 V, I _C = 60 A, R _G = 5 Ω, V _{GE} = 15 V, Inductive Load, T _C = 25°C | - | 23 | - | ns |
| t _r | Rise Time | | - | 58 | - | ns |
| t _{d(off)} | Turn-Off Delay Time | | - | 130 | - | ns |
| t _f | Fall Time | | - | 40 | 80 | ns |
| E _{on} | Turn-On Switching Loss | | - | 1.81 | - | mJ |
| E _{off} | Turn-Off Switching Loss | | - | 0.81 | - | mJ |
| E _{ts} | Total Switching Loss | | - | 2.62 | - | mJ |
| t _{d(on)} | Turn-On Delay Time | V _{CC} = 400 V, I _C = 60 A, R _G = 5 Ω, V _{GE} = 15 V, Inductive Load, T _C = 125°C | - | 22 | - | ns |
| t _r | Rise Time | | - | 61 | - | ns |
| t _{d(off)} | Turn-Off Delay Time | | - | 141 | - | ns |
| t _f | Fall Time | | - | 63 | - | ns |
| E _{on} | Turn-On Switching Loss | | - | 1.92 | - | mJ |
| E _{off} | Turn-Off Switching Loss | | - | 1.23 | - | mJ |
| E _{ts} | Total Switching Loss | | - | 3.15 | - | mJ |
| Q _g | Total Gate Charge | V _{CE} = 400 V, I _C = 60 A, V _{GE} = 15 V | - | 188 | - | nC |
| Q _{ge} | Gate to Emitter Charge | | - | 21 | - | nC |
| Q _{gc} | Gate to Collector Charge | | - | 97 | - | nC |

Electrical Characteristics of the Diode $T_C = 25^\circ\text{C}$ unless otherwise noted

| Symbol | Parameter | Test Conditions | Min. | Typ. | Max | Unit | |
|----------|-------------------------------|---|---------------------------|------|-----|------|----|
| V_{FM} | Diode Forward Voltage | $I_F = 30\text{ A}$ | $T_C = 25^\circ\text{C}$ | - | 2.0 | 2.6 | V |
| | | | $T_C = 125^\circ\text{C}$ | - | 1.8 | - | |
| t_{rr} | Diode Reverse Recovery Time | $I_F = 30\text{ A}, di_F/dt = 200\text{ A}/\mu\text{s}$ | $T_C = 25^\circ\text{C}$ | - | 47 | - | ns |
| | | | $T_C = 125^\circ\text{C}$ | - | 179 | - | |
| Q_{rr} | Diode Reverse Recovery Charge | $I_F = 30\text{ A}, di_F/dt = 200\text{ A}/\mu\text{s}$ | $T_C = 25^\circ\text{C}$ | - | 83 | - | nC |
| | | | $T_C = 125^\circ\text{C}$ | - | 567 | - | |



Typical Performance Characteristics

Figure 1. Typical Output Characteristics

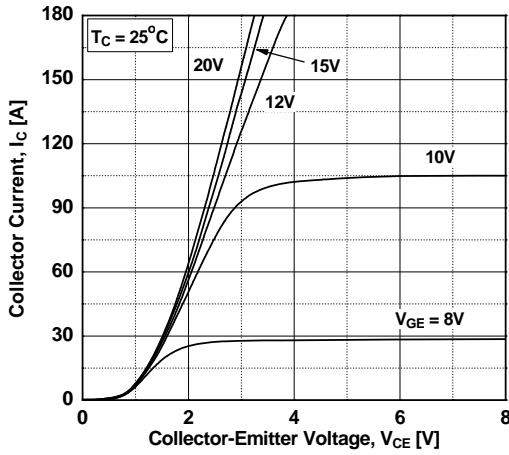

Figure 2. Typical Output Characteristics

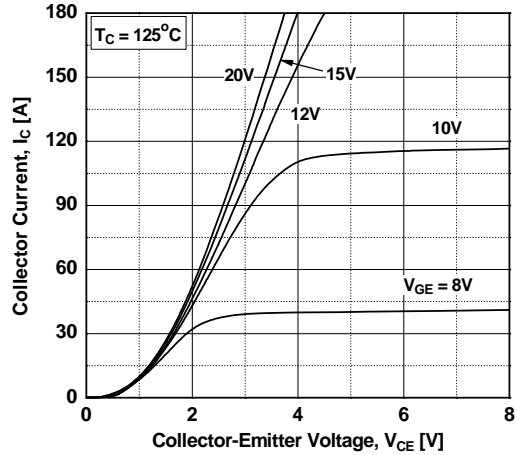

Figure 3. Typical Saturation Voltage Characteristics

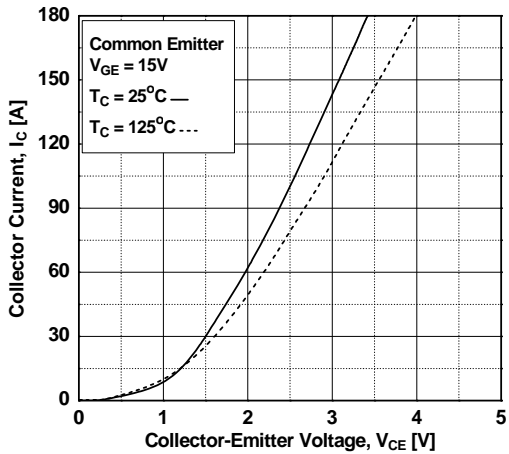

Figure 4. Transfer Characteristics

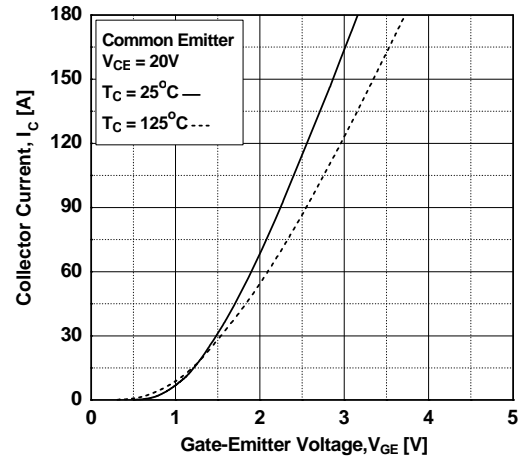

Figure 5. Saturation Voltage vs. Case Temperature at Variant Current Level

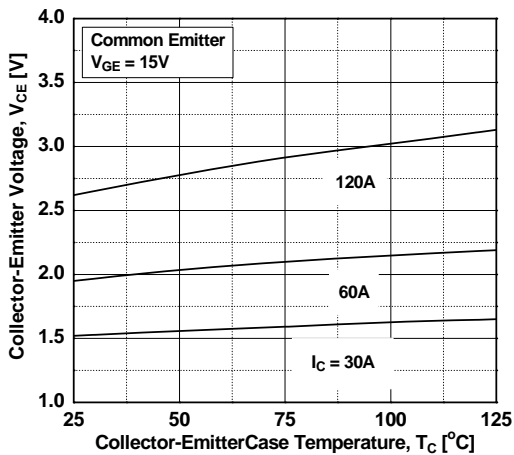
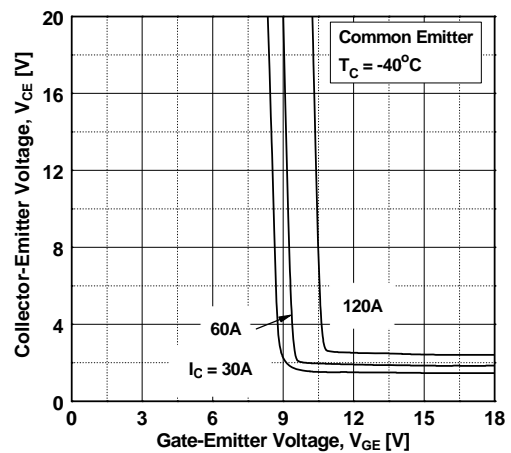

Figure 6. Saturation Voltage vs. Vge



Typical Performance Characteristics

Figure 7. Saturation Voltage vs. V_{GE}

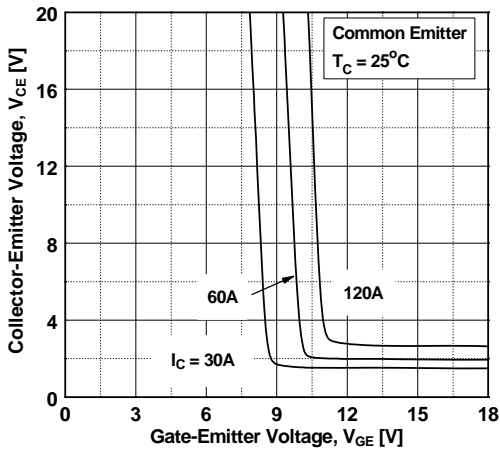

Figure 8. Saturation Voltage vs. V_{GE}

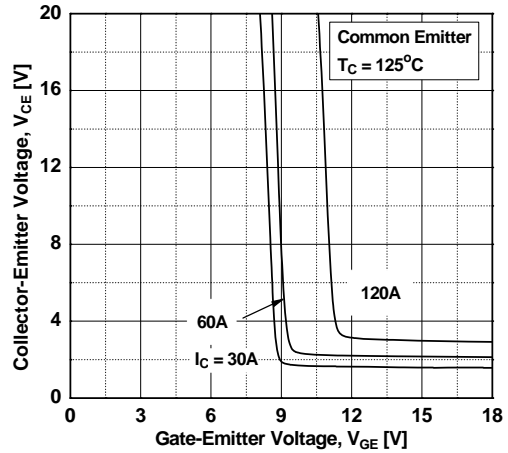

Figure 9. Capacitance Characteristics

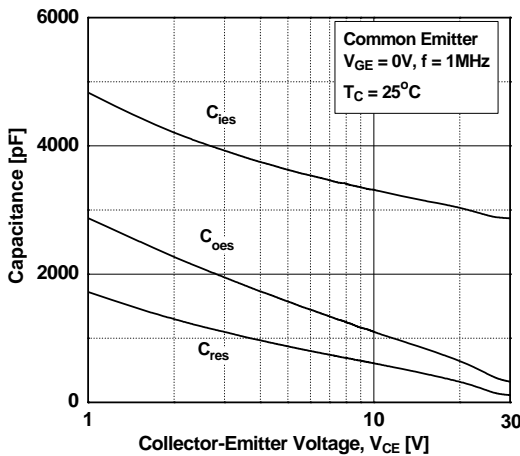

Figure 10. Gate charge Characteristics

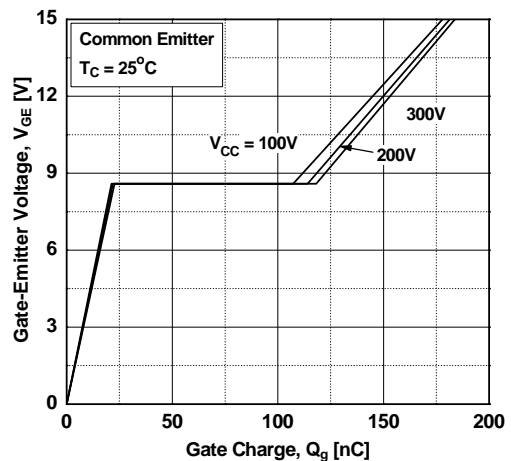

Figure 11. SOA Characteristics

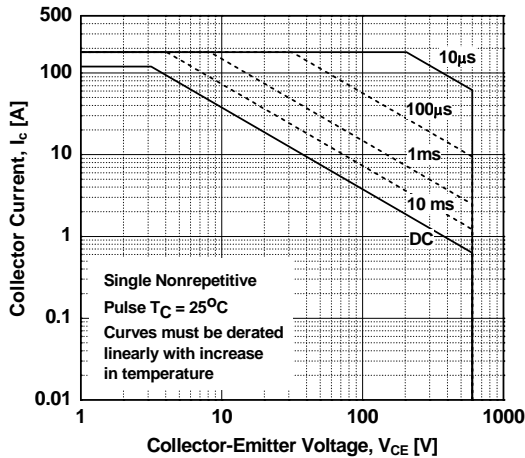
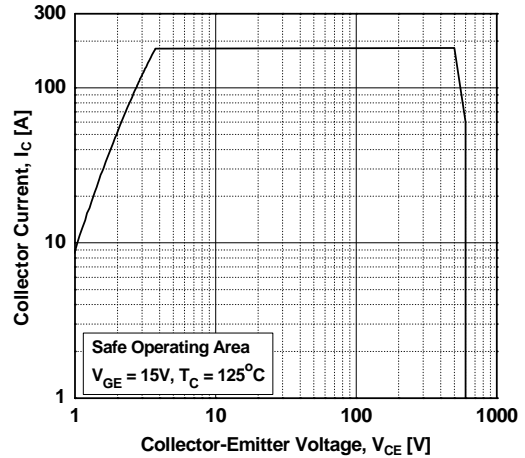

Figure 12. Turn off Switching SOA Characteristics



Typical Performance Characteristics

Figure 13. Turn-on Characteristics vs. Gate Resistance

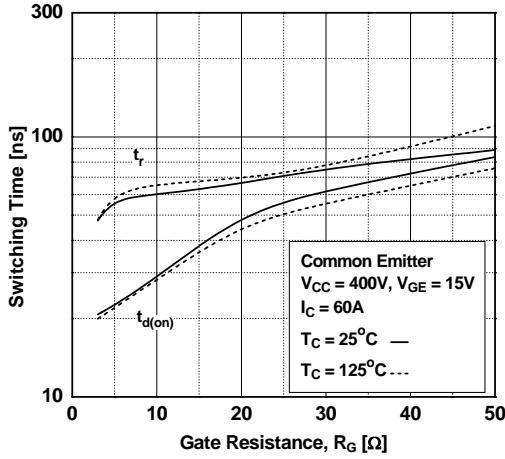

Figure 14. Turn-off Characteristics vs. Gate Resistance

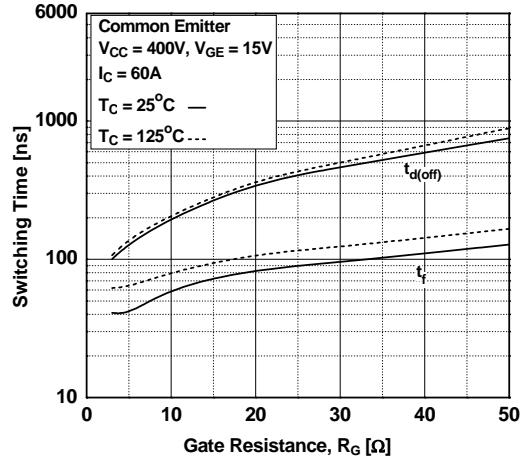

Figure 15. Turn-on Characteristics vs. Collector Current

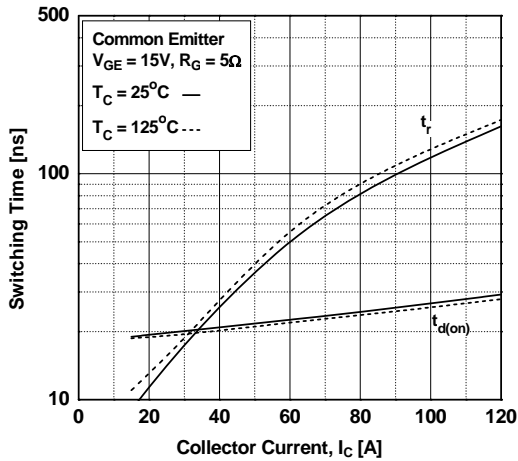

Figure 16. Turn-off Characteristics vs. Collector Current

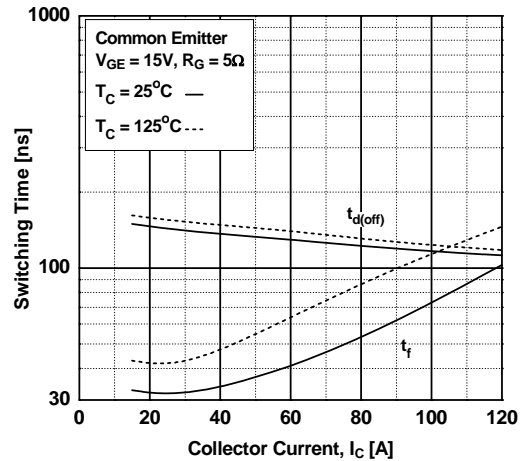

Figure 17. Switching Loss vs. Gate Resistance

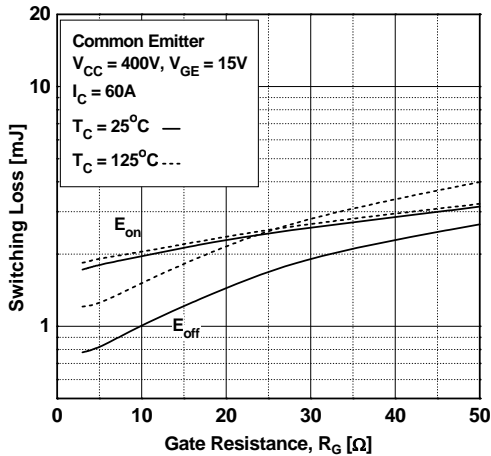
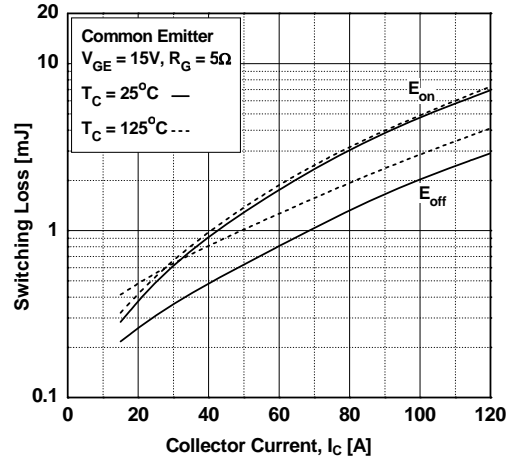

Figure 18. Switching Loss vs. Collector Current



Typical Performance Characteristics

Figure 19. Forward Characteristics

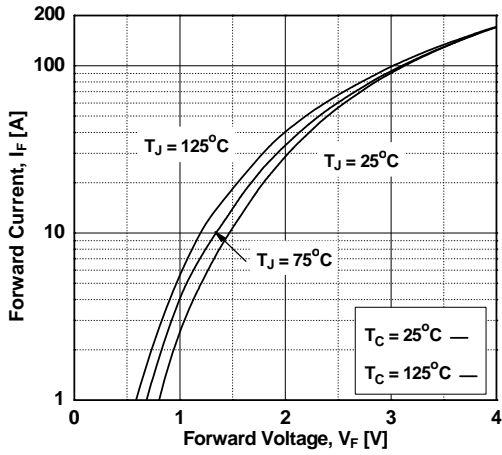

Figure 20. Reverse Current

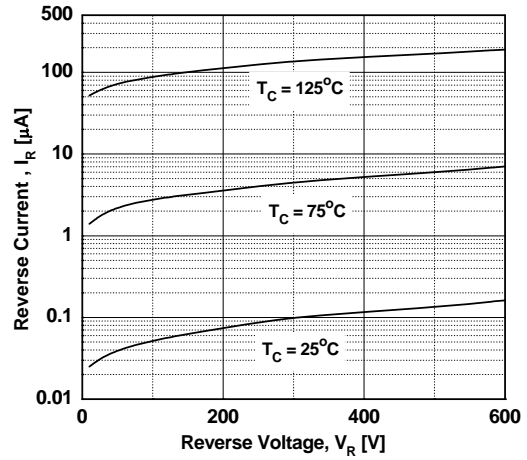

Figure 21. Stored Charge

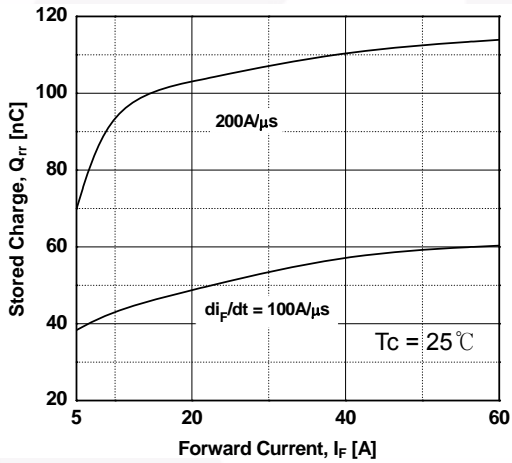

Figure 22. Reverse Recovery Time

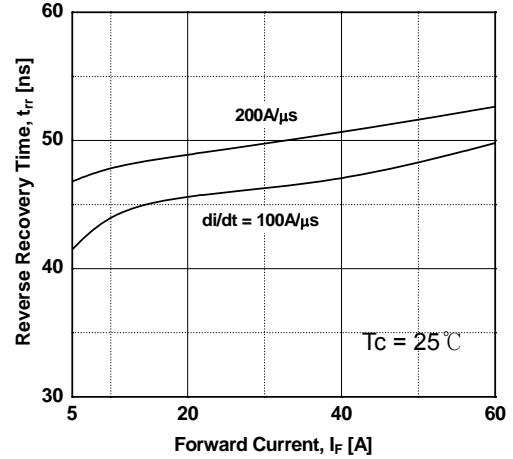
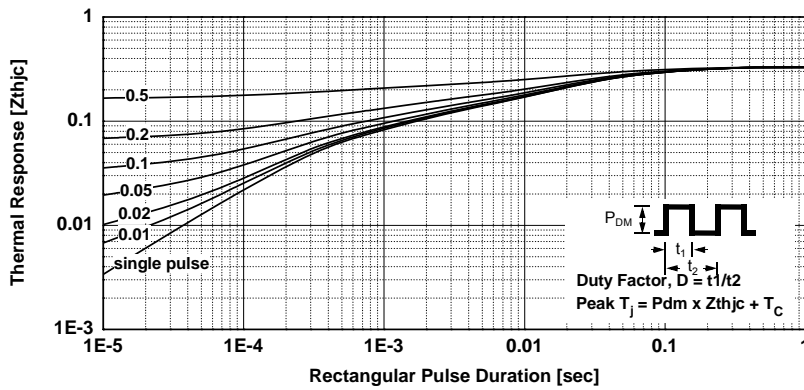

Figure 23. Transient Thermal Impedance of IGBT



ON Semiconductor and  are trademarks of Semiconductor Components Industries, LLC dba ON Semiconductor or its subsidiaries in the United States and/or other countries. ON Semiconductor owns the rights to a number of patents, trademarks, copyrights, trade secrets, and other intellectual property. A listing of ON Semiconductor's product/patent coverage may be accessed at www.onsemi.com/site/pdf/Patent-Marking.pdf. ON Semiconductor reserves the right to make changes without further notice to any products herein. ON Semiconductor makes no warranty, representation or guarantee regarding the suitability of its products for any particular purpose, nor does ON Semiconductor assume any liability arising out of the application or use of any product or circuit, and specifically disclaims any and all liability, including without limitation special, consequential or incidental damages. Buyer is responsible for its products and applications using ON Semiconductor products, including compliance with all laws, regulations and safety requirements or standards, regardless of any support or applications information provided by ON Semiconductor. "Typical" parameters which may be provided in ON Semiconductor data sheets and/or specifications can and do vary in different applications and actual performance may vary over time. All operating parameters, including "Typicals" must be validated for each customer application by customer's technical experts. ON Semiconductor does not convey any license under its patent rights nor the rights of others. ON Semiconductor products are not designed, intended, or authorized for use as a critical component in life support systems or any FDA Class 3 medical devices or medical devices with a same or similar classification in a foreign jurisdiction or any devices intended for implantation in the human body. Should Buyer purchase or use ON Semiconductor products for any such unintended or unauthorized application, Buyer shall indemnify and hold ON Semiconductor and its officers, employees, subsidiaries, affiliates, and distributors harmless against all claims, costs, damages, and expenses, and reasonable attorney fees arising out of, directly or indirectly, any claim of personal injury or death associated with such unintended or unauthorized use, even if such claim alleges that ON Semiconductor was negligent regarding the design or manufacture of the part. ON Semiconductor is an Equal Opportunity/Affirmative Action Employer. This literature is subject to all applicable copyright laws and is not for resale in any manner.

PUBLICATION ORDERING INFORMATION

LITERATURE FULFILLMENT:

Literature Distribution Center for ON Semiconductor
19521 E. 32nd Pkwy, Aurora, Colorado 80011 USA
Phone: 303-675-2175 or 800-344-3860 Toll Free USA/Canada
Fax: 303-675-2176 or 800-344-3867 Toll Free USA/Canada
Email: orderlit@onsemi.com

N. American Technical Support: 800-282-9855 Toll Free
USA/Canada
Europe, Middle East and Africa Technical Support:
Phone: 421 33 790 2910
Japan Customer Focus Center
Phone: 81-3-5817-1050

ON Semiconductor Website: www.onsemi.com
Order Literature: <http://www.onsemi.com/orderlit>
For additional information, please contact your local
Sales Representative

Mouser Electronics

Authorized Distributor

Click to View Pricing, Inventory, Delivery & Lifecycle Information:

[ON Semiconductor:](#)

[FGA60N60UFDTU](#)

Компания «Океан Электроники» предлагает заключение долгосрочных отношений при поставках импортных электронных компонентов на взаимовыгодных условиях!

Наши преимущества:

- Поставка оригинальных импортных электронных компонентов напрямую с производств Америки, Европы и Азии, а так же с крупнейших складов мира;
- Широкая линейка поставок активных и пассивных импортных электронных компонентов (более 30 млн. наименований);
- Поставка сложных, дефицитных, либо снятых с производства позиций;
- Оперативные сроки поставки под заказ (от 5 рабочих дней);
- Экспресс доставка в любую точку России;
- Помощь Конструкторского Отдела и консультации квалифицированных инженеров;
- Техническая поддержка проекта, помощь в подборе аналогов, поставка прототипов;
- Поставка электронных компонентов под контролем ВП;
- Система менеджмента качества сертифицирована по Международному стандарту ISO 9001;
- При необходимости вся продукция военного и аэрокосмического назначения проходит испытания и сертификацию в лаборатории (по согласованию с заказчиком);
- Поставка специализированных компонентов военного и аэрокосмического уровня качества (Xilinx, Altera, Analog Devices, Intersil, Interpoint, Microsemi, Actel, Aeroflex, Peregrine, VPT, Syfer, Eurofarad, Texas Instruments, MS Kennedy, Miteq, Cobham, E2V, MA-COM, Hittite, Mini-Circuits, General Dynamics и др.);

Компания «Океан Электроники» является официальным дистрибьютором и эксклюзивным представителем в России одного из крупнейших производителей разъемов военного и аэрокосмического назначения «JONHON», а так же официальным дистрибьютором и эксклюзивным представителем в России производителя высокотехнологичных и надежных решений для передачи СВЧ сигналов «FORSTAR».



JONHON

«JONHON» (основан в 1970 г.)

Разъемы специального, военного и аэрокосмического назначения:

(Применяются в военной, авиационной, аэрокосмической, морской, железнодорожной, горно- и нефтедобывающей отраслях промышленности)

«FORSTAR» (основан в 1998 г.)

ВЧ соединители, коаксиальные кабели, кабельные сборки и микроволновые компоненты:

(Применяются в телекоммуникациях гражданского и специального назначения, в средствах связи, РЛС, а так же военной, авиационной и аэрокосмической отраслях промышленности).



Телефон: 8 (812) 309-75-97 (многоканальный)

Факс: 8 (812) 320-03-32

Электронная почта: ocean@oceanchips.ru

Web: <http://oceanchips.ru/>

Адрес: 198099, г. Санкт-Петербург, ул. Калинина, д. 2, корп. 4, лит. А