

## GPS LOW NOISE AMPLIFIER GaAs MMIC

### ■ GENERAL DESCRIPTION

The NJG1108HA8 is a low noise amplifier GaAs MMIC designed for GPS. This amplifier provides low noise figure, high gain and high IP3 operated by single low positive power supply. This IC has the function of Stand-by mode. This amplifier can be tuned to wide frequency point (1.5GHz~2.7GHz) by changing the external matching components.

An ultra-small and ultra-thin package of the USB6-A8 is adopted.

### ■ PACKAGE OUTLINE

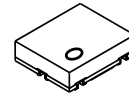

NJG1108HA8

### ■ FEATURES

- Low voltage operation +2.7V typ.
  - Low current consumption 2.0mA typ.
  - High gain 19dB typ.
  - Low noise figure 1.0dB typ.
  - Input power at 1dB gain compression point -15.0dBm typ.
  - High input IP3 0dBm typ.
  - Ultra-small and ultra-thin package USB6-A8 (Package size: 1.0x1.2x0.38mm)
- @  $V_{CTL}=1.85V$   
 @  $V_{CTL}=0V$   
 @  $V_{CTL}=1.85V, f=1.575GHz$   
 @  $V_{CTL}=1.85V, f=1.575GHz$   
 @  $V_{CTL}=1.85V, f=1.575GHz$   
 @  $V_{CTL}=1.85V, f=1.575+1.5751GHz$

### ■ PIN CONFIGURATION

(Top View)

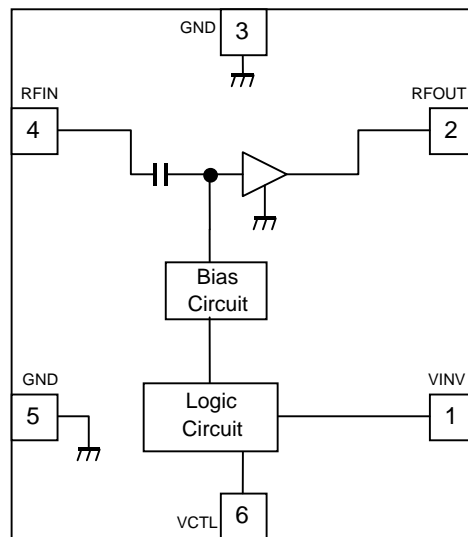

Pin Connection

1. VINV
2. RFOUT
3. GND
4. RFIN
5. GND
6. VCTL

### ■ TRUTH TABLE

“H”= $V_{CTL(H)}$ , “L”= $V_{CTL(L)}$

$V_{CTL}$	LNA Mode
H	Active Mode
L	Sleep Mode

Note: Specifications and description listed in this datasheet are subject to change without notice.

# NJG1108HA8

## ■ABSOLUTE MAXIMUM RATINGS

$T_a=+25^{\circ}\text{C}$ ,  $Z_s=Z_l=50\text{ohm}$

PARAMETER	SYMBOL	CONDITIONS	RATINGS	UNITS
Drain Voltage	$V_{DD}$		5.0	V
Inverter voltage	$V_{INV}$		5.0	V
Control voltage	$V_{CTL}$		5.0	V
Input power	$P_{in}$	$V_{DD}=2.7\text{V}$	+15	dBm
Power dissipation	$P_D$	On PCB board, $T_{jmax}=150^{\circ}\text{C}$	150	mW
Operating temperature	$T_{opr}$		-40~+85	$^{\circ}\text{C}$
Storage temperature	$T_{stg}$		-55~+150	$^{\circ}\text{C}$

## ■ELECTRICAL CHARACTERISTICS 1

GENERAL CONDITIONS:  $V_{DD}=V_{INV}=2.7\text{V}$ ,  $T_a=+25^{\circ}\text{C}$ ,  $Z_s=Z_l=50\text{ohm}$ , with application circuit

PARAMETERS	SYMBOL	CONDITIONS	MIN	TYP	MAX	UNITS
Operating voltage	$V_{DD}$		2.5	2.7	3.5	V
Inverter supply voltage	$V_{INV}$		2.5	2.7	3.5	V
Control voltage (High)	$V_{CTL(H)}$		1.5	1.85	$V_{INV}+0.3$	V
Control voltage (Low)	$V_{CTL(L)}$		0	0	0.3	V
Operating current1 (Active Mode, RF OFF)	$I_{DD1}$	RF OFF, $V_{CTL}=1.85\text{V}$	-	2.0	3.0	mA
Operating current2 (Sleep Mode, RF OFF)	$I_{DD2}$	RF OFF, $V_{CTL}=0\text{V}$	-	1	5	$\mu\text{A}$
Inverter current1	$I_{INV1}$	RF OFF, $V_{CTL}=1.85\text{V}$	-	30	60	$\mu\text{A}$
Inverter current2	$I_{INV2}$	RF OFF, $V_{CTL}=0\text{V}$	-	9	20	$\mu\text{A}$
Control current	$I_{CTL}$	RF OFF, $V_{CTL}=1.85\text{V}$	-	6	20	$\mu\text{A}$

**ELECTRICAL CHARACTERISTICS 2 (Active Mode)**

GENERAL CONDITIONS:  $V_{DD}=V_{INV}=2.7V$ ,  $V_{CTL}=1.85V$ ,  $f_{RF}=1575MHz$ ,  $T_a=+25^{\circ}C$ ,  $Z_s=Z_l=50ohm$ , with application circuit

PARAMETERS	SYMBOL	CONDITIONS	MIN	TYP	MAX	UNITS
Operating Frequency	freq		1.57	1.575	1.58	GHz
Small signal gain	Gain		17.0	19.0	21.5	dB
Noise figure	NF	Exclude PCB & connector losses (IN: 0.05dB)	-	1.0	1.2	dB
Input power at 1dB gain compression point	$P_{-1dB(IN)}$		-19.0	-15.0	-	dBm
Input 3rd order intercept point	IIP3	$f1=f_{RF}$ , $f2=f_{RF}+100kHz$ , $Pin=-34dBm$	-5.0	0	-	dBm
RF IN VSWR	VSWR <sub>i</sub>		-	2.0	2.5	
RF OUT VSWR	VSWR <sub>o</sub>		-	1.5	2.0	

# NJG1108HA8

## ■ TERMINAL INFORMATION

No.	SYMBOL	DESCRIPTION
1	VINV	Power supply pin of the inverter circuit.
2	RFOUT	RF Output and voltage supply pin. External matching circuits and a bypass capacitor is required. L3 is a RF choke inductor. These elements are used as output matching circuit.
3	GND	Ground pin. To keep good RF grounding performance, please use multiple via holes to connect with ground plane and this pin.)
4	RFIN	RF input pin. A DC blocking capacitor is not required. An external matching circuit is required.
5	GND	Ground pin. To keep good RF grounding performance, please use multiple via holes to connect with ground plane and this pin.)
6	VCTL	Control voltage input pin. This control pin is set to high. LNA suffers from standby state when LNA puts the changeover voltage of "Low" in a state of movement when the changeover voltage of "High" is put in this terminal.

### CAUTION

1) Ground terminal (3, 5) should be connected to the ground plane as low inductance as possible.

## ■ ELECTRICAL CHARACTERISTICS

(Conditions:  $V_{DD}=V_{INV}=2.7V$ ,  $V_{CTL}=1.85V$ ,  $f_{RF}=1575MHz$ ,  $T_a=+25^\circ C$ ,  $Z_s=Z_l=50\Omega$ , with application circuit)

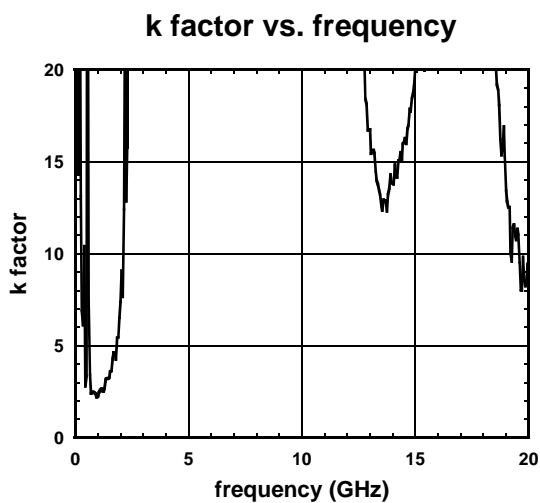
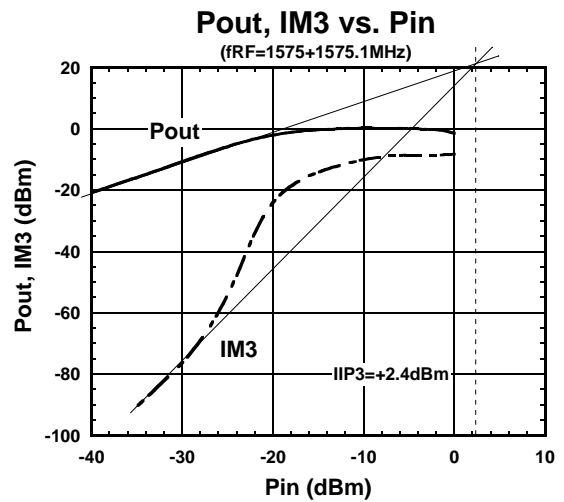
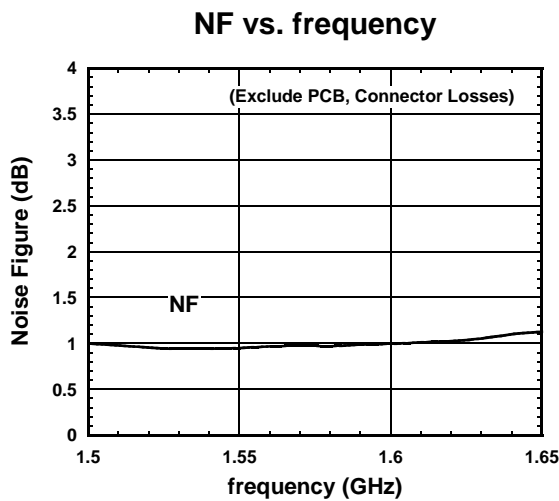
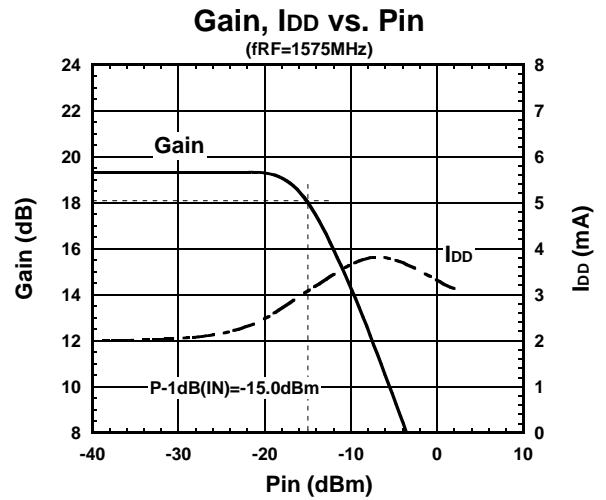
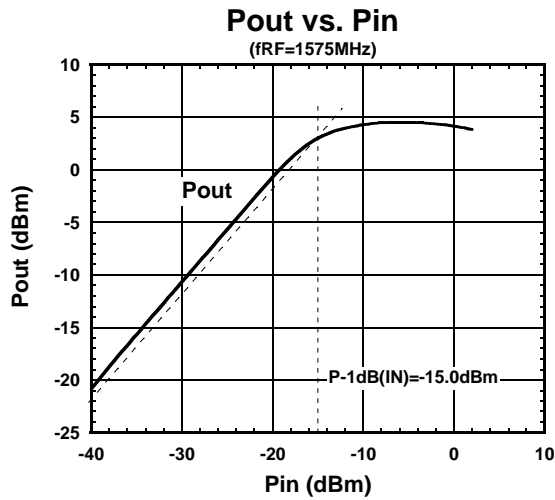

# NJG1108HA8

## ■ ELECTRICAL CHARACTERISTICS

(Conditions:  $V_{DD}=V_{INV}=2.7V$ ,  $V_{CTL}=1.85V$ ,  $f_{RF}=1575MHz$ ,  $T_a=+25^\circ C$ ,  $Z_s=Z_l=50\Omega$ , with application circuit)

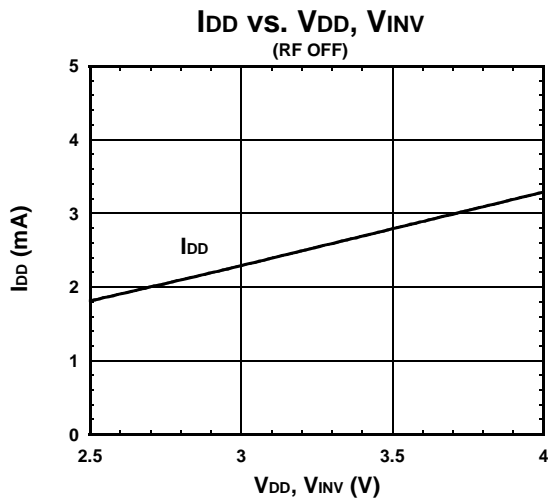
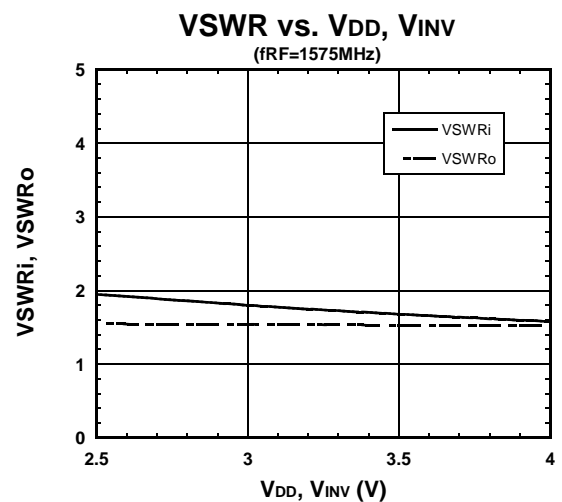
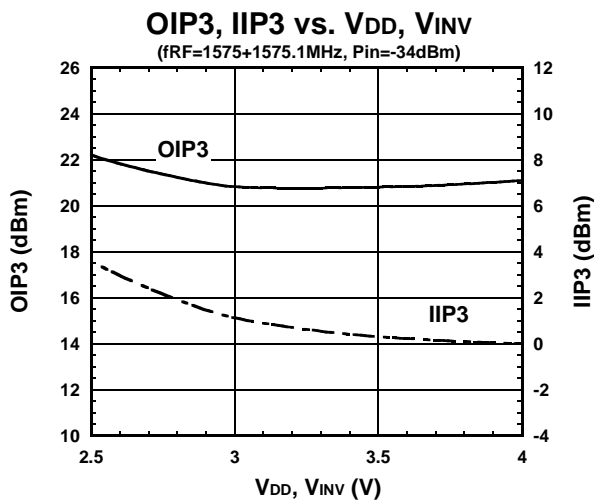
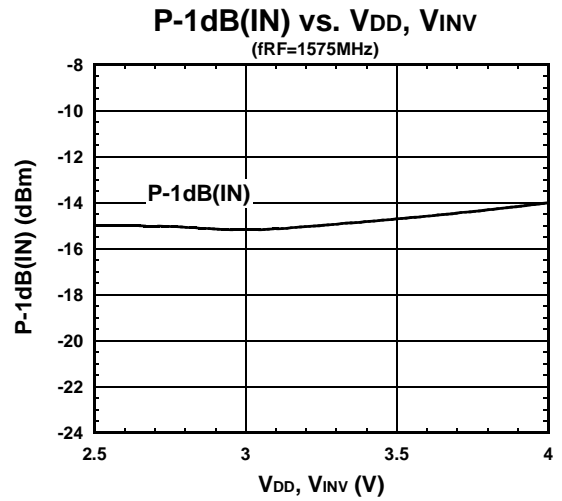
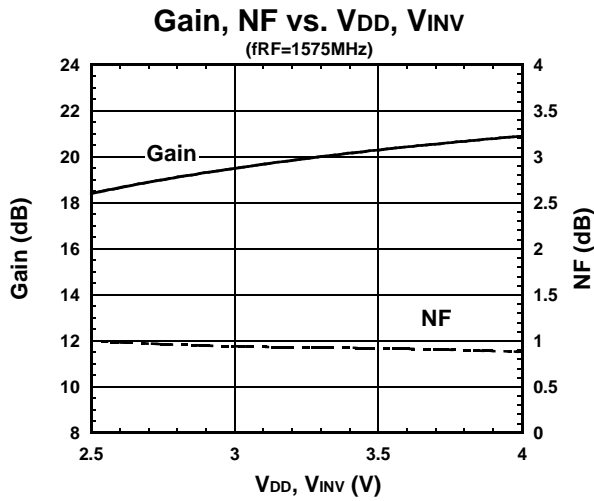

## ■ ELECTRICAL CHARACTERISTICS

(Conditions:  $V_{DD}=V_{INV}=2.7V$ ,  $V_{CTL}=1.85V$ ,  $f_{RF}=1575MHz$ ,  $T_a=+25^\circ C$ ,  $Z_s=Z_i=50\Omega$ , with application circuit)

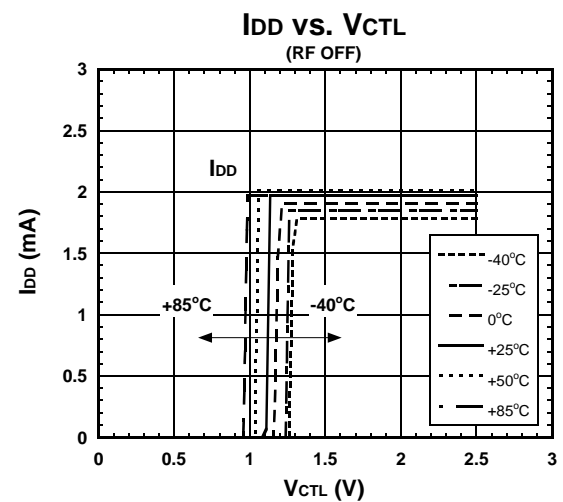
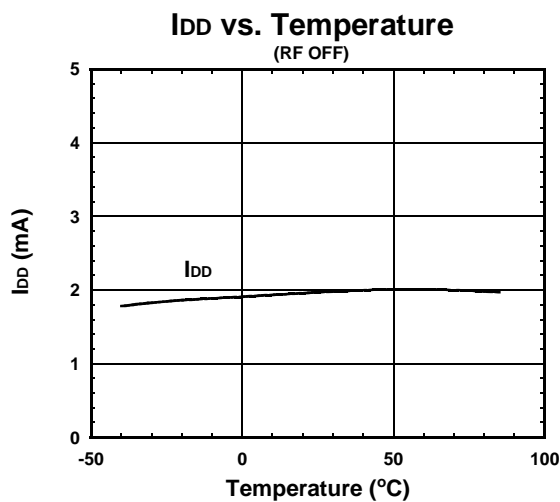
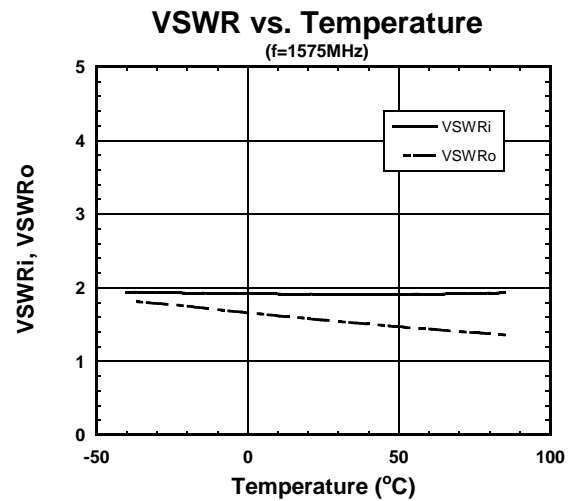
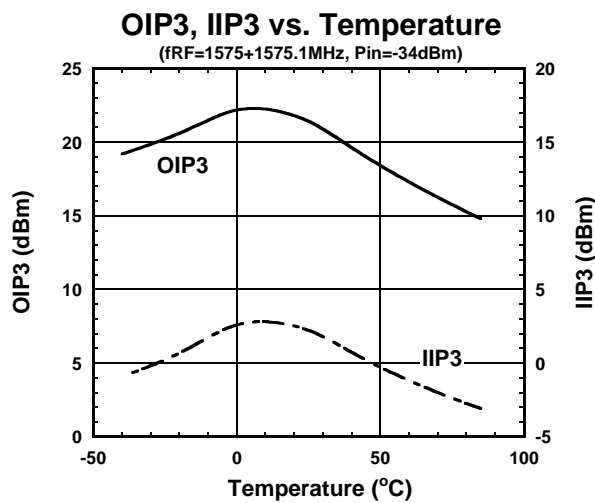
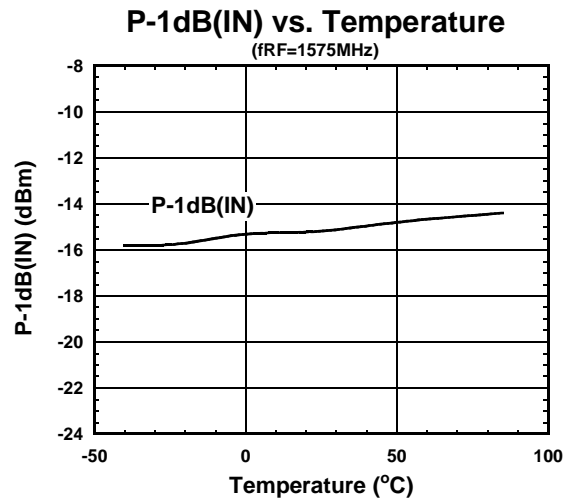
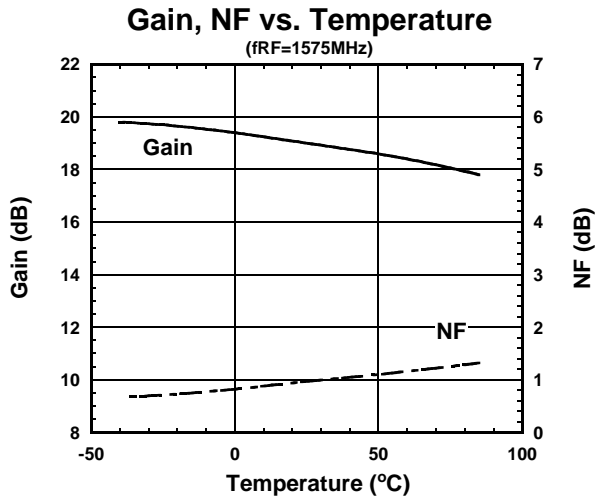

# NJG1108HA8

## ELECTRICAL CHARACTERISTICS

(Conditions:  $V_{DD}=V_{INV}=2.7V$ ,  $V_{CTL}=1.85V$ ,  $f_{RF}=1575MHz$ ,  $T_a=+25^\circ C$ ,  $Z_s=Z_l=50\Omega$ , with application circuit)

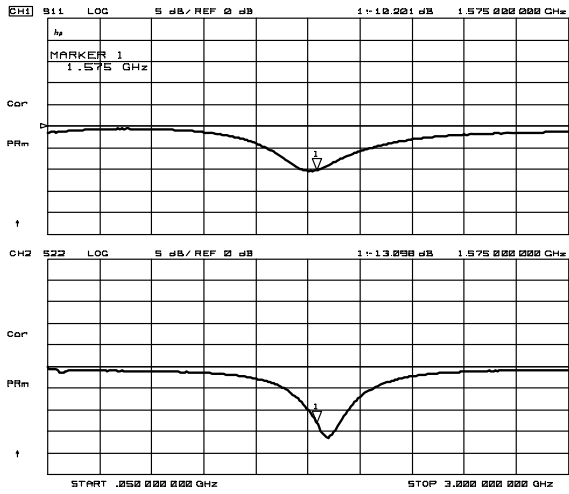

S11, S22

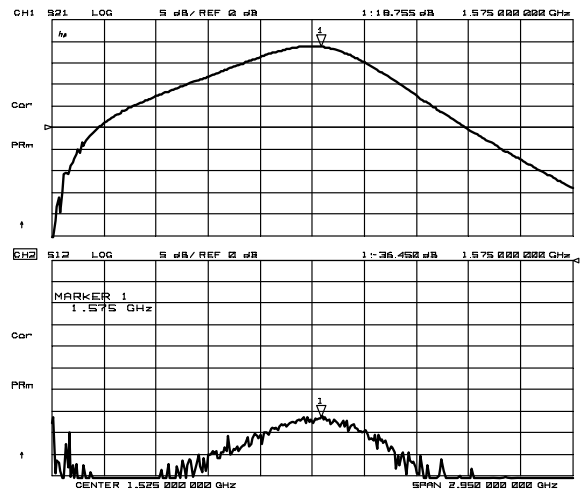

S21, S22

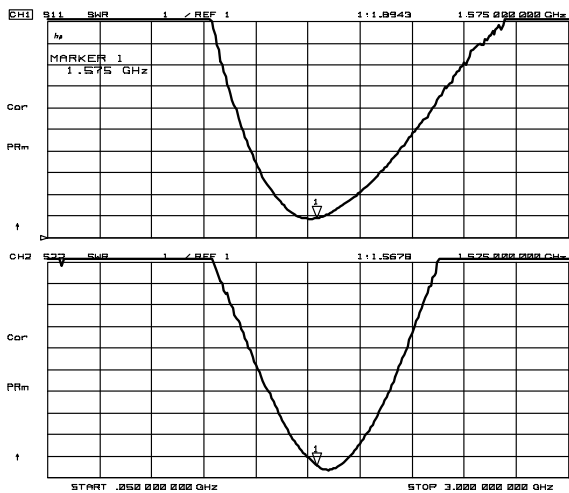

VSWR

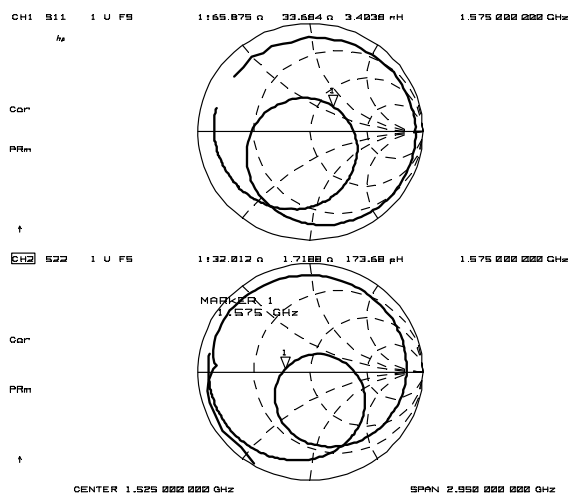

Zin, Zout

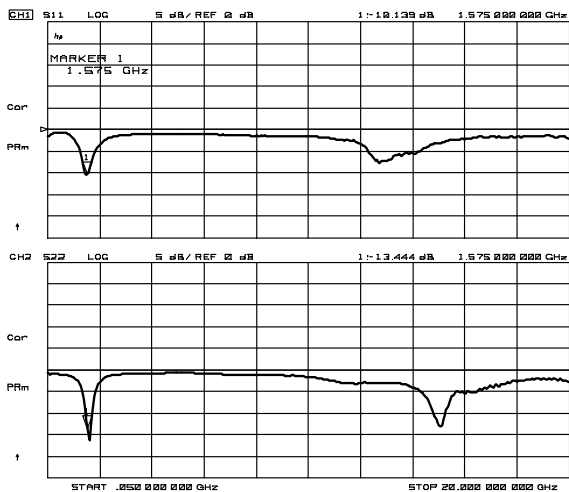

S11, S22 (f=50MHz~20GHz)

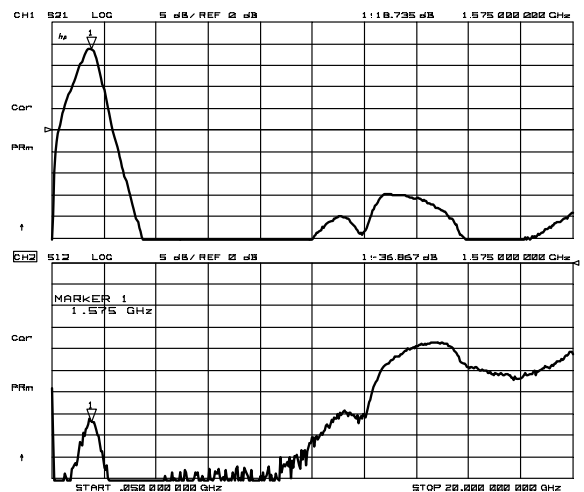

S21, S22 (f=50MHz~20GHz)



## APPLICATION CIRCUIT

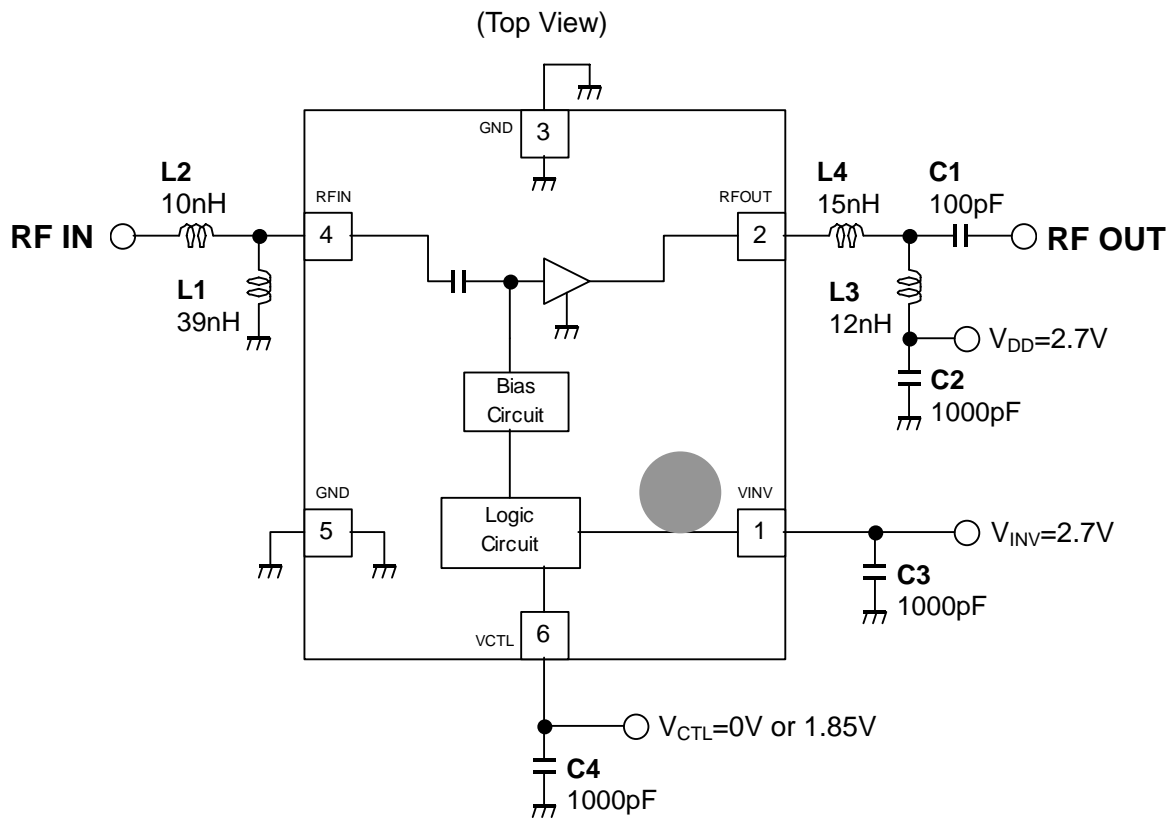

## TEST PCB LAYOUT

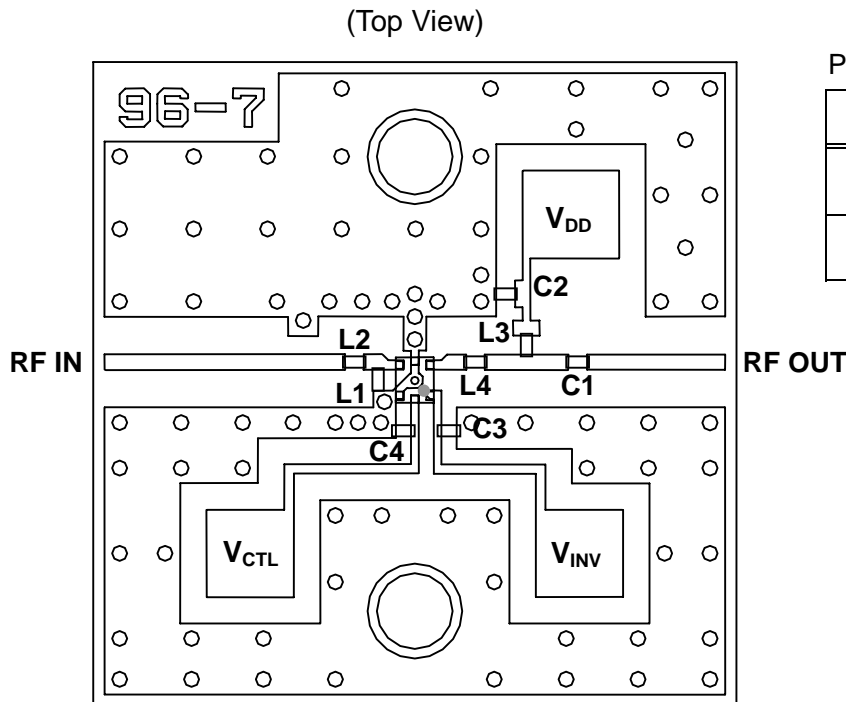

### Parts List

Parts ID	Notes
L1~L4	MURATA (LQP03T series)
C1~C3	MURATA (GRM03 series)

PCB (FR-4): t=0.2mm  
 MICROSTRIP LINE WIDTH  
 =0.4mm ( $Z_0=50\text{ohm}$ )  
 PCB SIZE=17.0mmx17.0mm

# NJG1108HA8

## PACKAGE OUTLINE (USB6-A8)

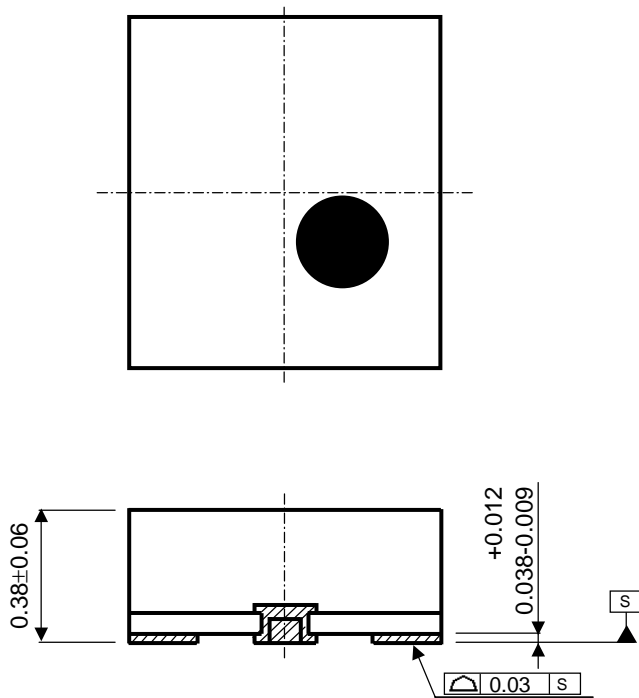

TERMINAL TREAT :Au  
 Substrate :FR5  
 Molding material :Epoxy resin  
 UNIT :mm  
 WEIGHT :1.1mg

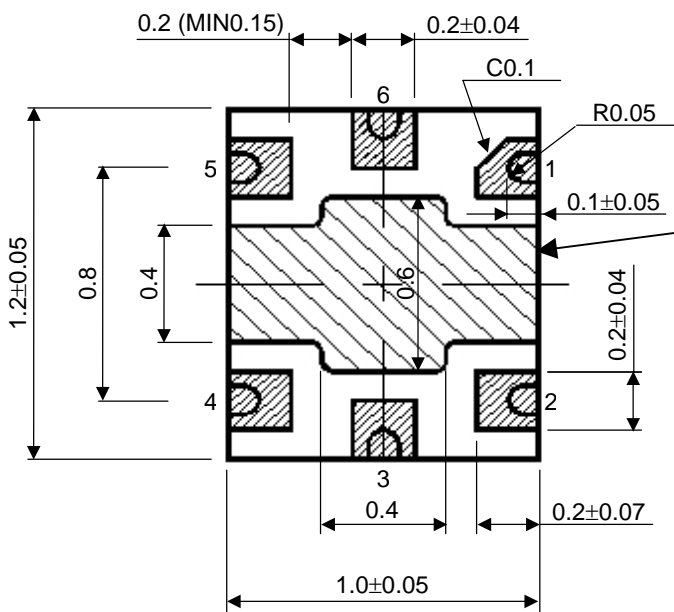
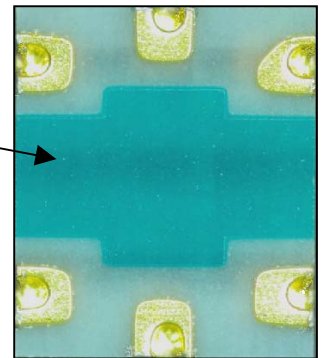

Photo resist coating



### Cautions on using this product

This product contains Gallium-Arsenide (GaAs) which is a harmful material.

- Do NOT eat or put into mouth.
- Do NOT dispose in fire or break up this product.
- Do NOT chemically make gas or powder with this product.
- To waste this product, please obey the relating law of your country.

### [CAUTION]

The specifications on this databook are only given for information, without any guarantee as regards either mistakes or omissions. The application circuits in this databook are described only to show representative usages of the product and not intended for the guarantee or permission of any right including the industrial rights.

This product may be damaged with electric static discharge (ESD) or spike voltage. Please handle with care to avoid these damages.

# Mouser Electronics

Authorized Distributor

Click to View Pricing, Inventory, Delivery & Lifecycle Information:

[NJR:](#)

[NJG1108HA8-TE1](#)

Компания «Океан Электроники» предлагает заключение долгосрочных отношений при поставках импортных электронных компонентов на взаимовыгодных условиях!

Наши преимущества:

- Поставка оригинальных импортных электронных компонентов напрямую с производств Америки, Европы и Азии, а так же с крупнейших складов мира;
- Широкая линейка поставок активных и пассивных импортных электронных компонентов (более 30 млн. наименований);
- Поставка сложных, дефицитных, либо снятых с производства позиций;
- Оперативные сроки поставки под заказ (от 5 рабочих дней);
- Экспресс доставка в любую точку России;
- Помощь Конструкторского Отдела и консультации квалифицированных инженеров;
- Техническая поддержка проекта, помощь в подборе аналогов, поставка прототипов;
- Поставка электронных компонентов под контролем ВП;
- Система менеджмента качества сертифицирована по Международному стандарту ISO 9001;
- При необходимости вся продукция военного и аэрокосмического назначения проходит испытания и сертификацию в лаборатории (по согласованию с заказчиком);
- Поставка специализированных компонентов военного и аэрокосмического уровня качества (Xilinx, Altera, Analog Devices, Intersil, Interpoint, Microsemi, Actel, Aeroflex, Peregrine, VPT, Syfer, Eurofarad, Texas Instruments, MS Kennedy, Miteq, Cobham, E2V, MA-COM, Hittite, Mini-Circuits, General Dynamics и др.);

Компания «Океан Электроники» является официальным дистрибьютором и эксклюзивным представителем в России одного из крупнейших производителей разъемов военного и аэрокосмического назначения «JONHON», а так же официальным дистрибьютором и эксклюзивным представителем в России производителя высокотехнологичных и надежных решений для передачи СВЧ сигналов «FORSTAR».



## JONHON

«JONHON» (основан в 1970 г.)

Разъемы специального, военного и аэрокосмического назначения:

(Применяются в военной, авиационной, аэрокосмической, морской, железнодорожной, горно- и нефтедобывающей отраслях промышленности)

«FORSTAR» (основан в 1998 г.)

ВЧ соединители, коаксиальные кабели, кабельные сборки и микроволновые компоненты:

(Применяются в телекоммуникациях гражданского и специального назначения, в средствах связи, РЛС, а так же военной, авиационной и аэрокосмической отраслях промышленности).



Телефон: 8 (812) 309-75-97 (многоканальный)

Факс: 8 (812) 320-03-32

Электронная почта: [ocean@oceanchips.ru](mailto:ocean@oceanchips.ru)

Web: <http://oceanchips.ru/>

Адрес: 198099, г. Санкт-Петербург, ул. Калинина, д. 2, корп. 4, лит. А