



Is Now Part of



ON Semiconductor®

To learn more about ON Semiconductor, please visit our website at
www.onsemi.com

Please note: As part of the Fairchild Semiconductor integration, some of the Fairchild orderable part numbers will need to change in order to meet ON Semiconductor's system requirements. Since the ON Semiconductor product management systems do not have the ability to manage part nomenclature that utilizes an underscore (_), the underscore (_) in the Fairchild part numbers will be changed to a dash (-). This document may contain device numbers with an underscore (_). Please check the ON Semiconductor website to verify the updated device numbers. The most current and up-to-date ordering information can be found at www.onsemi.com. Please email any questions regarding the system integration to Fairchild_questions@onsemi.com.

ON Semiconductor and the ON Semiconductor logo are trademarks of Semiconductor Components Industries, LLC dba ON Semiconductor or its subsidiaries in the United States and/or other countries. ON Semiconductor owns the rights to a number of patents, trademarks, copyrights, trade secrets, and other intellectual property. A listing of ON Semiconductor's product/patent coverage may be accessed at www.onsemi.com/site/pdf/Patent-Marking.pdf. ON Semiconductor reserves the right to make changes without further notice to any products herein. ON Semiconductor makes no warranty, representation or guarantee regarding the suitability of its products for any particular purpose, nor does ON Semiconductor assume any liability arising out of the application or use of any product or circuit, and specifically disclaims any and all liability, including without limitation special, consequential or incidental damages. Buyer is responsible for its products and applications using ON Semiconductor products, including compliance with all laws, regulations and safety requirements or standards, regardless of any support or applications information provided by ON Semiconductor. "Typical" parameters which may be provided in ON Semiconductor data sheets and/or specifications can and do vary in different applications and actual performance may vary over time. All operating parameters, including "Typicals" must be validated for each customer application by customer's technical experts. ON Semiconductor does not convey any license under its patent rights nor the rights of others. ON Semiconductor products are not designed, intended, or authorized for use as a critical component in life support systems or any FDA Class 3 medical devices or medical devices with a same or similar classification in a foreign jurisdiction or any devices intended for implantation in the human body. Should Buyer purchase or use ON Semiconductor products for any such unintended or unauthorized application, Buyer shall indemnify and hold ON Semiconductor and its officers, employees, subsidiaries, affiliates, and distributors harmless against all claims, costs, damages, and expenses, and reasonable attorney fees arising out of, directly or indirectly, any claim of personal injury or death associated with such unintended or unauthorized use, even if such claim alleges that ON Semiconductor was negligent regarding the design or manufacture of the part. ON Semiconductor is an Equal Opportunity/Affirmative Action Employer. This literature is subject to all applicable copyright laws and is not for resale in any manner.

FOD2741A, FOD2741B, FOD2741C

Optically Isolated Error Amplifier

Features

- Optocoupler, precision reference and error amplifier in single package
- 2.5V reference
- CTR 100% to 200%
- 5,000V RMS isolation
- UL approved E90700, Volume 2
CSA approval 1296837
VDE approval 40002463
BSI approval 8702, 8703
- Low temperature coefficient 50ppm/°C max.
- FOD2741A: tolerance 0.5%
FOD2741B: tolerance 1%
FOD2741C: tolerance 2%

Applications

- Power supplies regulation
- DC to DC converters

Description

The FOD2741 Optically Isolated Amplifier consists of the popular KA431 precision programmable shunt reference and an optocoupler. The optocoupler is a gallium arsenide (GaAs) light emitting diode optically coupled to a silicon phototransistor. It comes in 3 grades of reference voltage tolerance = 2%, 1%, and 0.5%.

The Current Transfer Ratio (CTR) ranges from 100% to 200%. It also has an outstanding temperature coefficient of 50 ppm/°C. It is primarily intended for use as the error amplifier/reference voltage/optocoupler function in isolated AC to DC power supplies and DC/DC converters.

When using the FOD2741, power supply designers can reduce the component count and save space in tightly packaged designs. The tight tolerance reference eliminates the need for adjustments in many applications. The device comes in a 8-pin dip white package.

Functional Block Diagram



Package Outlines



Pin Definitions

Pin Number	Pin Name	Pin Description
1	NC	Not connected
2	C	Phototransistor Collector
3	E	Phototransistor Emitter
4	NC	Not connected
5	GND	Ground
6	COMP	Error Amplifier Compensation. This pin is the output of the error amplifier.*
7	FB	Voltage Feedback. This pin is the inverting input to the error amplifier
8	LED	Anode LED. This pin is the input to the light emitting diode.

*The compensation network must be attached between pins 6 and 7.

Typical Application



Absolute Maximum Ratings ($T_A = 25^\circ\text{C}$ unless otherwise specified)

Stresses exceeding the absolute maximum ratings may damage the device. The device may not function or be operable above the recommended operating conditions and stressing the parts to these levels is not recommended. In addition, extended exposure to stresses above the recommended operating conditions may affect device reliability. The absolute maximum ratings are stress ratings only.

Symbol	Parameter	Value	Units
T_{STG}	Storage Temperature	-40 to +125	$^\circ\text{C}$
T_{OPR}	Operating Temperature	-40 to +85	$^\circ\text{C}$
T_{SOL}	Lead Solder Temperature	260 for 10 sec.	$^\circ\text{C}$
V_{LED}	Input Voltage	37	V
I_{LED}	Input DC Current	20	mA
V_{CEO}	Collector-Emitter Voltage	30	V
V_{ECO}	Emitter-Collector Voltage	7	V
I_C	Collector Current	50	mA
PD1	Input Power Dissipation ⁽¹⁾	145	mW
PD2	Transistor Power Dissipation ⁽²⁾	85	mW
PD3	Total Power Dissipation ⁽³⁾	145	mW

Notes:

1. Derate linearly from 25°C at a rate of $2.42\text{mW}/^\circ\text{C}$
2. Derate linearly from 25°C at a rate of $1.42\text{mW}/^\circ\text{C}$.
3. Derate linearly from 25°C at a rate of $2.42\text{mW}/^\circ\text{C}$.

Electrical Characteristics (T_A = 25°C unless otherwise specified)

Input Characteristics

Symbol	Parameter	Test Conditions	Device	Min.	Typ.	Max.	Unit	
V _F	LED Forward Voltage	I _{LED} = 10mA, V _{COMP} = V _{FB} (Fig.1)	All			1.5	V	
V _{REF}	Reference Voltage	I _{LED} = 10mA, V _{COMP} = V _{FB}	FOD2741A	2.482	2.495	2.508	V	
			FOD2741B	2.470	2.495	2.520	V	
			FOD2741C	2.450	2.500	2.550	V	
V _{REF (DEV)} ⁽⁴⁾	Deviation of V _{REF} Over Temperature	T _A = -25°C to +85°C	All		4.5	17	mV	
ΔV _{REF} / ΔV _{COMP}	Ratio of V _{REF} Variation to the Output of the Error Amplifier	I _{LED} = 10mA	All	ΔV _{COMP} = 10V to V _{REF}		-1.0	-2.7	mV/V
				ΔV _{COMP} = 36V to 10V		-0.5	-2.0	
I _{REF}	Feedback Input Current	I _{LED} = 10mA, R ₁ = 10kΩ (Fig. 3)	All		1.5	4	μA	
I _{REF (DEV)} ⁽⁴⁾	Deviation of I _{REF} Over Temperature	T _A = -25°C to +85°C	All		0.4	1.2	μA	
I _{LED (MIN)}	Minimum Drive Current	V _{COMP} = V _{FB} (Fig. 1)	All		0.45	1.0	mA	
I _(OFF)	Off-state Error Amplifier Current	V _{LED} = 37V, V _{FB} = 0 (Fig. 4)	All		0.05	1.0	μA	
Z _{OUT}	Error Amplifier Output impedance ⁽⁵⁾	V _{COMP} = V _{REF} , I _{LED} = 1mA to 20mA, f ≥ 1.0 kHz	All		0.15	0.5	Ω	

Output Characteristics

Symbol	Parameter	Test Conditions	Min.	Typ.	Max.	Unit
I _{CEO}	Collector Dark Current	V _{CE} = 10V (Fig. 5)			50	nA
BV _{ECO}	Emitter-Collector Voltage Breakdown	I _E = 100μA	7			V
BV _{CEO}	Collector-Emitter Voltage Breakdown	I _C = 1.0mA	70			V

Transfer Characteristics

Symbol	Parameter	Test Conditions	Min.	Typ.	Max.	Unit
CTR	Current Transfer Ratio	I _{LED} = 10mA, V _{COMP} = V _{FB} , V _{CE} = 5V (Fig. 6)	100		200	%
V _{CE (SAT)}	Collector-Emitter Saturation Voltage	I _{LED} = 10mA, V _{COMP} = V _{FB} , I _C = 2.5mA (Fig. 6)			0.4	V

Notes:

4. The deviation parameters V_{REF(DEV)} and I_{REF(DEV)} are defined as the differences between the maximum and minimum values obtained over the rated temperature range. The average full-range temperature coefficient of the reference input voltage, ΔV_{REF}, is defined as:

$$|\Delta V_{REF}|(\text{ppm}/^\circ\text{C}) = \frac{\{V_{REF(DEV)}/V_{REF}(T_A = 25^\circ\text{C})\} \times 10^6}{\Delta T_A}$$

where ΔT_A is the rated operating free-air temperature range of the device.

5. The dynamic impedance is defined as |Z_{OUT}| = ΔV_{COMP} / ΔI_{LED}. When the device is operating with two external resistors (see Figure 2), the total dynamic impedance of the circuit is given by:

$$|Z_{OUT, TOT}| = \frac{\Delta V}{\Delta I} \approx |Z_{OUT}| \times \left[1 + \frac{R1}{R2} \right]$$

Electrical Characteristics (Continued) ($T_A = 25^\circ\text{C}$ unless otherwise specified)**Isolation Characteristics**

Symbol	Parameter	Test Conditions	Min.	Typ.	Max.	Unit
I_{I-O}	Input-Output Insulation Leakage Current	RH = 45%, $T_A = 25^\circ\text{C}$, $t = 5\text{s}$, $V_{I-O} = 3000\text{ VDC}^{(6)}$			1.0	μA
V_{ISO}	Withstand Insulation Voltage	RH $\leq 50\%$, $T_A = 25^\circ\text{C}$, $t = 1\text{ min.}^{(6)}$	5000			Vrms
R_{I-O}	Resistance (Input to Output)	$V_{I-O} = 500\text{ VDC}^{(6)}$		10^{12}		Ω

Switching Characteristics

Symbol	Parameter	Test Conditions	Min.	Typ.	Max.	Unit
BW	Bandwidth	(Fig. 7)		50		kHZ
CMH	Common Mode Transient Immunity at Output HIGH	$I_{LED} = 0\text{mA}$, $ V_{cm} = 10\text{ V}_{PP}$, $R_L = 2.2\text{k}\Omega^{(7)}$ (Fig. 8)		1.0		$\text{kV}/\mu\text{s}$
CML	Common Mode Transient Immunity at Output LOW	$(I_{LED} = 1\text{mA}$, $ V_{cm} = 10\text{ V}_{PP}$, $R_L = 2.2\text{k}\Omega^{(7)}$ (Fig. 8)		1.0		$\text{kV}/\mu\text{s}$

Notes:

- Device is considered as a two terminal device: Pins 1, 2, 3 and 4 are shorted together and Pins 5, 6, 7 and 8 are shorted together.
- Common mode transient immunity at output high is the maximum tolerable (positive) dV_{cm}/dt on the leading edge of the common mode impulse signal, V_{cm} , to assure that the output will remain high. Common mode transient immunity at output low is the maximum tolerable (negative) dV_{cm}/dt on the trailing edge of the common pulse signal, V_{cm} , to assure that the output will remain low.

Test Circuits



Figure 1. V_{REF} , V_F , I_{LED} (min.) Test Circuit



Figure 2. $\Delta V_{REF} / \Delta V_{COMP}$ Test Circuit



Figure 3. I_{REF} Test Circuit



Figure 4. $I_{(OFF)}$ Test Circuit

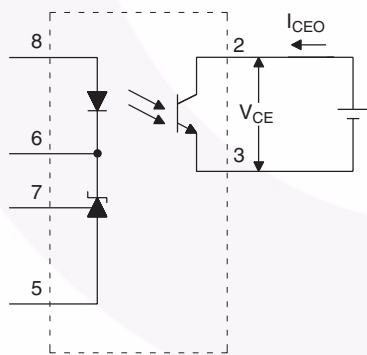


Figure 5. I_{CEO} Test Circuit



Figure 6. CTR , $V_{CE(sat)}$ Test Circuit

Test Circuits (Continued)



Figure 7. Frequency Response Test Circuit.



Figure 8. CMH and CML Test Circuit

Typical Performance Curves

Fig. 9a – LED Current vs. Cathode Voltage



Fig. 9b – LED Current vs. Cathode Voltage

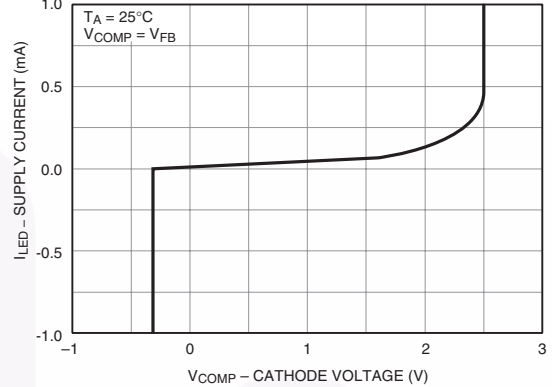


Fig. 10 – Reference Voltage vs. Ambient Temperature



Fig. 11 – Reference Current vs. Ambient Temperature



Fig. 12 – Off-State Current vs. Ambient Temperature



Fig. 13 – Forward Current vs. Forward Voltage



Typical Performance Curves (Continued)

Fig. 14 – Dark Current vs. Ambient Temperature



Fig. 15 – Collector Current vs. Ambient Temperature



Fig. 16 – Current Transfer Ratio vs. LED Current



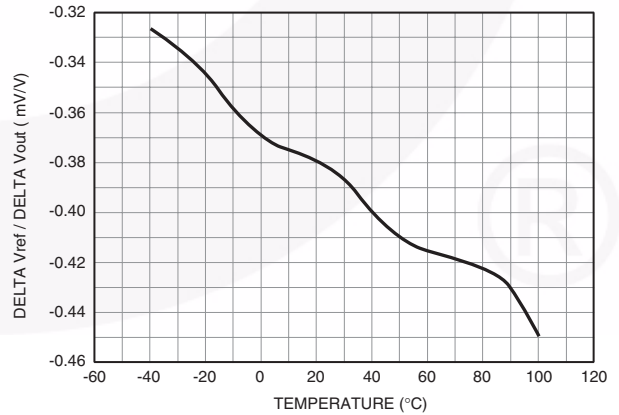
Fig. 17 – Saturation Voltage vs. Ambient Temperature



Fig. 18 – Collector Current vs. Collector Voltage

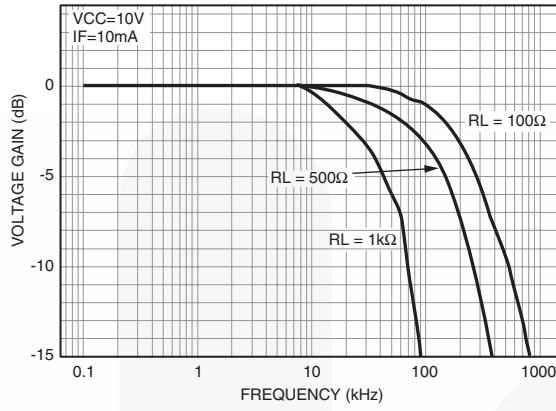


Fig. 19 – Rate of Change V_{ref} to V_{out} vs. Temperature



Typical Performance Curves (Continued)

Fig. 20 – Voltage Gain vs. Frequency



The FOD2741

The FOD2741 is an optically isolated error amplifier. It incorporates three of the most common elements necessary to make an isolated power supply, a reference voltage, an error amplifier, and an optocoupler. It is functionally equivalent to the popular KA431 shunt voltage regulator plus the CNY17F-X optocoupler.

Powering the Secondary Side

The LED pin in the FOD2741 powers the secondary side, and in particular provides the current to run the LED. The actual structure of the FOD2741 dictates the minimum voltage that can be applied to the LED pin: The error amplifier output has a minimum of the reference voltage, and the LED is in series with that. Minimum voltage applied to the LED pin is thus $2.5V + 1.5V = 4.0V$. This voltage can be generated either directly from the output of the converter, or else from a slaved secondary winding. The secondary winding will not affect regulation, as the input to the FB pin may still be taken from the output winding.

The LED pin needs to be fed through a current limiting resistor. The value of the resistor sets the amount of current through the LED, and thus must be carefully selected in conjunction with the selection of the primary side resistor.

Feedback

Output voltage of a converter is determined by selecting a resistor divider from the regulated output to the FB pin. The FOD2741 attempts to regulate its FB pin to the reference voltage, 2.5V. The ratio of the two resistors should thus be:

$$\frac{R_{TOP}}{R_{BOTTOM}} = \frac{V_{OUT}}{V_{REF}} - 1$$

The absolute value of the top resistor is set by the input offset current of $5.2\mu A$. To achieve 0.5% accuracy, the resistance of R_{TOP} should be:

$$\frac{V_{OUT} - 2.5}{R_{TOP}} > 1040\mu A$$

Compensation

The compensation pin of the FOD2741 provides the opportunity for the designer to design the frequency response of the converter. A compensation network may be placed between the COMP pin and the FB pin. In typical low-bandwidth systems, a $0.1\mu F$ capacitor may be used. For converters with more stringent requirements, a network should be designed based on measurements of the system's loop. An excellent reference for this process may be found in "Practical Design of Power Supplies" by Ron Lenk, IEEE Press, 1998.

Secondary Ground

The GND pin should be connected to the secondary ground of the converter.

No Connect Pins

The NC pins have no internal connection. They should not have any connection to the secondary side, as this may compromise the isolation structure.

Photo-Transistor

The Photo-transistor is the output of the FOD2741. In a normal configuration the collector will be attached to a pull-up resistor and the emitter grounded. There is no base connection necessary.

The value of the pull-up resistor, and the current limiting resistor feeding the LED, must be carefully selected to account for voltage range accepted by the PWM IC, and for the variation in current transfer ratio (CTR) of the opto-isolator itself.

Example: The voltage feeding the LED pins is +12V, the voltage feeding the collector pull-up is +10V, and the PWM IC is the Fairchild KA1H0680, which has a 5V reference. If we select a $10k\Omega$ resistor for the LED, the maximum current the LED can see is:

$$(12V - 4V) / 10k\Omega = 800\mu A.$$

The CTR of the opto-isolator is a minimum of 100%, so the minimum collector current of the photo-transistor when the diode is full on is also $800\mu A$. The collector resistor must thus be such that:

$$\frac{10V - 5V}{R_{COLLECTOR}} < 800\mu A \text{ or } R_{COLLECTOR} > 6.25k\Omega;$$

select $12k\Omega$ to allow some margin.

Ordering Information

Option	Example Part Number	Description
No Option	FOD2741A	Standard Through Hole
S	FOD2741AS	Surface Mount Lead Bend
SD	FOD2741ASD	Surface Mount; Tape and Reel
T	FOD2741AT	0.4" Lead Spacing
V	FOD2741AV	VDE0884
TV	FOD2741ATV	VDE0884; 0.4" Lead Spacing
SV	FOD2741ASV	VDE0884; Surface Mount
SDV	FOD2741ASDV	VDE0884; Surface Mount; Tape and Reel

Marking Information



Definitions	
1	Fairchild logo
2	Device number
3	VDE mark (Note: Only appears on parts ordered with VDE option – See order entry table)
4	Two digit year code, e.g., '03'
5	Two digit work week ranging from '01' to '53'
6	Assembly package code

Carrier Tape Specifications



Symbol	Description	Dimension in mm
W	Tape Width	16.0 ± 0.3
t	Tape Thickness	0.30 ± 0.05
P ₀	Sprocket Hole Pitch	4.0 ± 0.1
D ₀	Sprocket Hole Diameter	1.55 ± 0.05
E	Sprocket Hole Location	1.75 ± 0.10
F	Pocket Location	7.5 ± 0.1
P ₂		4.0 ± 0.1
P	Pocket Pitch	12.0 ± 0.1
A ₀	Pocket Dimensions	10.30 ± 0.20
B ₀		10.30 ± 0.20
K ₀		4.90 ± 0.20
W ₁	Cover Tape Width	1.6 ± 0.1
d	Cover Tape Thickness	0.1 max
	Max. Component Rotation or Tilt	10°
R	Min. Bending Radius	30

Reflow Profile

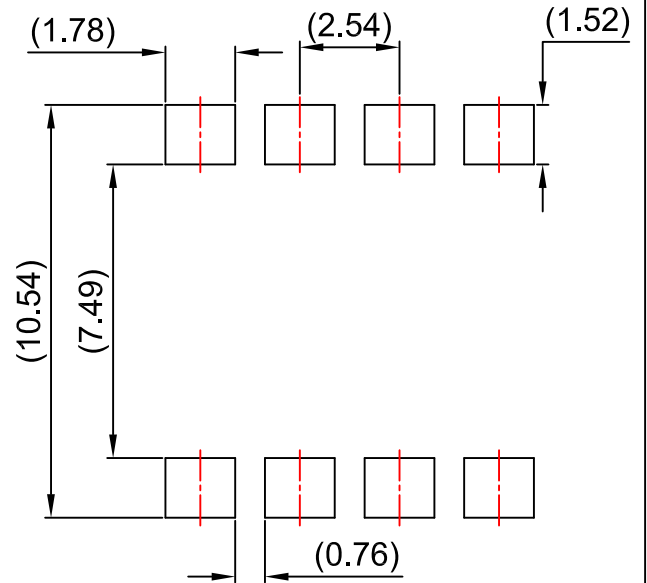
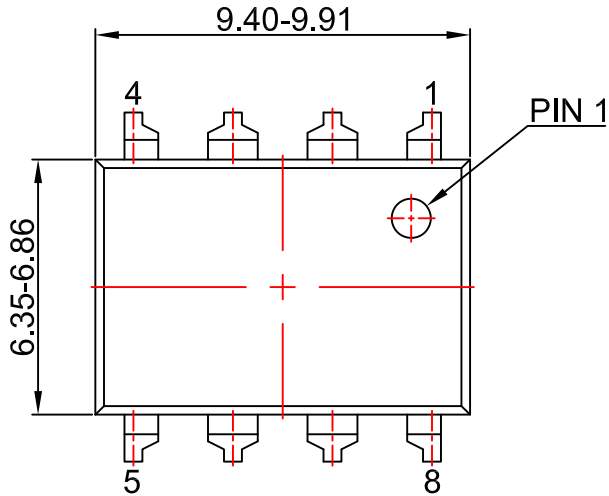


- Peak reflow temperature: 260C (package surface temperature)
- Time of temperature higher than 183C for 160 seconds or less
- One time soldering reflow is recommended

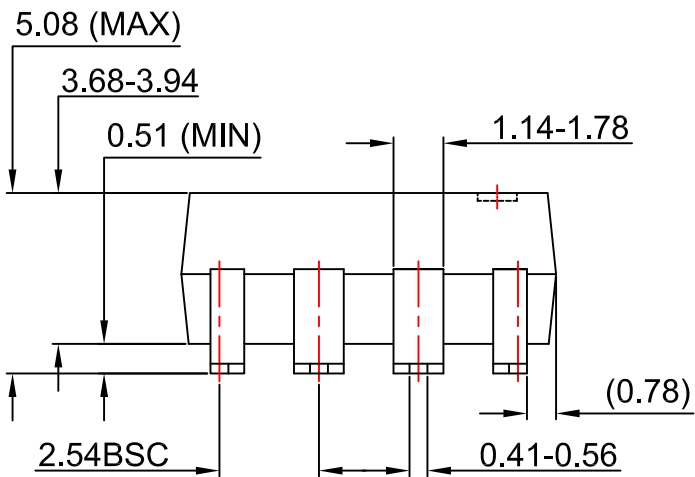


- NOTES:
- A) NO STANDARD APPLIES TO THIS PACKAGE
 - B) ALL DIMENSIONS ARE IN MILLIMETERS.
 - C) DIMENSIONS ARE EXCLUSIVE OF BURRS, MOLD FLASH, AND TIE BAR EXTRUSION
 - D) DRAWING FILENAME AND REVISION: MKT-N08GREV7





LAND PATTERN RECOMMENDATION



NOTES:

- A) NO STANDARD APPLIES TO THIS PACKAGE
- B) ALL DIMENSIONS ARE IN MILLIMETERS.
- C) DIMENSIONS ARE EXCLUSIVE OF BURRS, MOLD FLASH, AND TIE BAR EXTRUSION
- D) DRAWING FILENAME AND REVISION: MKT-N08Hrev7.





PIN 1

15.0° (MAX)

10.16 (TYP)

0.20-0.40



NOTES:

- A) NO STANDARD APPLIES TO THIS PACKAGE
- B) ALL DIMENSIONS ARE IN MILLIMETERS.
- C) DIMENSIONS ARE EXCLUSIVE OF BURRS, MOLD FLASH, AND TIE BAR EXTRUSION
- D) DRAWING FILENAME AND REVISION: MKT-N08REV7



ON Semiconductor and  are trademarks of Semiconductor Components Industries, LLC dba ON Semiconductor or its subsidiaries in the United States and/or other countries. ON Semiconductor owns the rights to a number of patents, trademarks, copyrights, trade secrets, and other intellectual property. A listing of ON Semiconductor's product/patent coverage may be accessed at www.onsemi.com/site/pdf/Patent-Marking.pdf. ON Semiconductor reserves the right to make changes without further notice to any products herein. ON Semiconductor makes no warranty, representation or guarantee regarding the suitability of its products for any particular purpose, nor does ON Semiconductor assume any liability arising out of the application or use of any product or circuit, and specifically disclaims any and all liability, including without limitation special, consequential or incidental damages. Buyer is responsible for its products and applications using ON Semiconductor products, including compliance with all laws, regulations and safety requirements or standards, regardless of any support or applications information provided by ON Semiconductor. "Typical" parameters which may be provided in ON Semiconductor data sheets and/or specifications can and do vary in different applications and actual performance may vary over time. All operating parameters, including "Typicals" must be validated for each customer application by customer's technical experts. ON Semiconductor does not convey any license under its patent rights nor the rights of others. ON Semiconductor products are not designed, intended, or authorized for use as a critical component in life support systems or any FDA Class 3 medical devices or medical devices with a same or similar classification in a foreign jurisdiction or any devices intended for implantation in the human body. Should Buyer purchase or use ON Semiconductor products for any such unintended or unauthorized application, Buyer shall indemnify and hold ON Semiconductor and its officers, employees, subsidiaries, affiliates, and distributors harmless against all claims, costs, damages, and expenses, and reasonable attorney fees arising out of, directly or indirectly, any claim of personal injury or death associated with such unintended or unauthorized use, even if such claim alleges that ON Semiconductor was negligent regarding the design or manufacture of the part. ON Semiconductor is an Equal Opportunity/Affirmative Action Employer. This literature is subject to all applicable copyright laws and is not for resale in any manner.

PUBLICATION ORDERING INFORMATION

LITERATURE FULFILLMENT:

Literature Distribution Center for ON Semiconductor
19521 E. 32nd Pkwy, Aurora, Colorado 80011 USA
Phone: 303-675-2175 or 800-344-3860 Toll Free USA/Canada
Fax: 303-675-2176 or 800-344-3867 Toll Free USA/Canada
Email: orderlit@onsemi.com

N. American Technical Support: 800-282-9855 Toll Free
USA/Canada
Europe, Middle East and Africa Technical Support:
Phone: 421 33 790 2910
Japan Customer Focus Center
Phone: 81-3-5817-1050

ON Semiconductor Website: www.onsemi.com
Order Literature: <http://www.onsemi.com/orderlit>
For additional information, please contact your local
Sales Representative

Mouser Electronics

Authorized Distributor

Click to View Pricing, Inventory, Delivery & Lifecycle Information:

[ON Semiconductor:](#)

[FOD2741BSD](#) [FOD2741BSV](#) [FOD2741BTV](#) [FOD2741B](#) [FOD2741BS](#) [FOD2741BV](#) [FOD2741BSDV](#)

Компания «Океан Электроники» предлагает заключение долгосрочных отношений при поставках импортных электронных компонентов на взаимовыгодных условиях!

Наши преимущества:

- Поставка оригинальных импортных электронных компонентов напрямую с производств Америки, Европы и Азии, а так же с крупнейших складов мира;
- Широкая линейка поставок активных и пассивных импортных электронных компонентов (более 30 млн. наименований);
- Поставка сложных, дефицитных, либо снятых с производства позиций;
- Оперативные сроки поставки под заказ (от 5 рабочих дней);
- Экспресс доставка в любую точку России;
- Помощь Конструкторского Отдела и консультации квалифицированных инженеров;
- Техническая поддержка проекта, помощь в подборе аналогов, поставка прототипов;
- Поставка электронных компонентов под контролем ВП;
- Система менеджмента качества сертифицирована по Международному стандарту ISO 9001;
- При необходимости вся продукция военного и аэрокосмического назначения проходит испытания и сертификацию в лаборатории (по согласованию с заказчиком);
- Поставка специализированных компонентов военного и аэрокосмического уровня качества (Xilinx, Altera, Analog Devices, Intersil, Interpoint, Microsemi, Actel, Aeroflex, Peregrine, VPT, Syfer, Eurofarad, Texas Instruments, MS Kennedy, Miteq, Cobham, E2V, MA-COM, Hittite, Mini-Circuits, General Dynamics и др.);

Компания «Океан Электроники» является официальным дистрибьютором и эксклюзивным представителем в России одного из крупнейших производителей разъемов военного и аэрокосмического назначения «JONHON», а так же официальным дистрибьютором и эксклюзивным представителем в России производителя высокотехнологичных и надежных решений для передачи СВЧ сигналов «FORSTAR».



JONHON

«JONHON» (основан в 1970 г.)

Разъемы специального, военного и аэрокосмического назначения:

(Применяются в военной, авиационной, аэрокосмической, морской, железнодорожной, горно- и нефтедобывающей отраслях промышленности)

«FORSTAR» (основан в 1998 г.)

ВЧ соединители, коаксиальные кабели, кабельные сборки и микроволновые компоненты:

(Применяются в телекоммуникациях гражданского и специального назначения, в средствах связи, РЛС, а так же военной, авиационной и аэрокосмической отраслях промышленности).



Телефон: 8 (812) 309-75-97 (многоканальный)

Факс: 8 (812) 320-03-32

Электронная почта: ocean@oceanchips.ru

Web: <http://oceanchips.ru/>

Адрес: 198099, г. Санкт-Петербург, ул. Калинина, д. 2, корп. 4, лит. А