

## Features

- 3528 1.9mm SMD LED
- High Brightness
- AllnGaP / InGaN Technology
- Small package
- High reliability
- Clear Lens

## Applications

- Consumer Electronics
- Wearable
- Automobile After Market
- Industrial Equipment

## Description

The IN-P32AT series is a popular low profile 3528 package with versatile design capabilities. It is a PLCC type silicone style LED which can be used in various applications.

## Recommended Solder Pattern

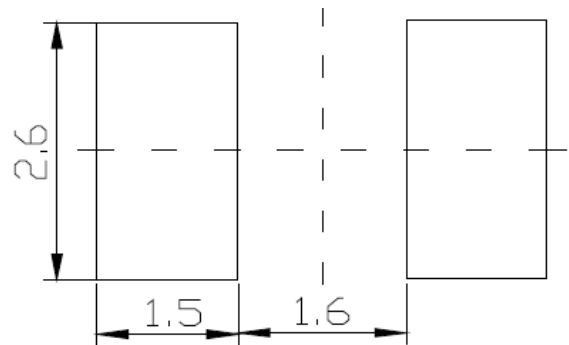

Figure 1. IN-P32AT Solder Pattern

## Package Dimensions in mm

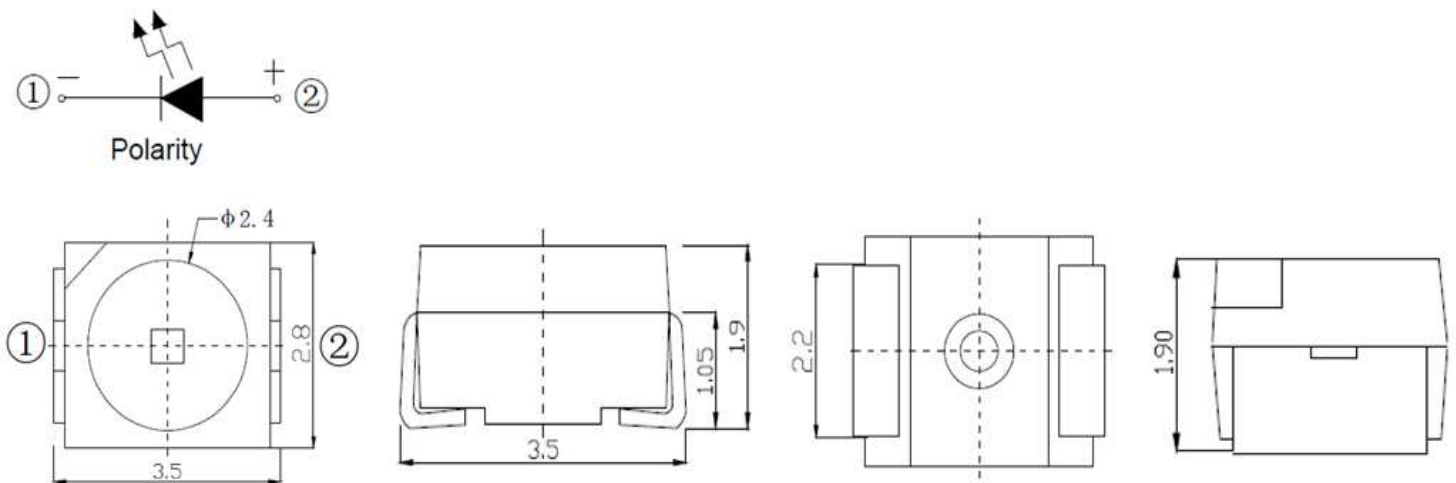

Figure 2. IN-P32AT Package Dimensions

**Absolute Maximum Rating at 25°C** (Note 1)

Product	Emission Color	P <sub>d</sub> (mW)	I <sub>F</sub> (mA)	I <sub>FP</sub> * (mA)	V <sub>R</sub> (V)	T <sub>OP</sub> (°C)	T <sub>ST</sub> (°C)
IN-P32ATYG	Yellow Green	90	30	70	5	-30°C~+85°C	-40°C~+90°C
IN-P32ATY	Yellow	75	30				
IN-P32ATA	Amber	75	30				
IN-P32ATR	Red	90	30				
IN-P32ATB	Blue	90	30	100	5	-30°C~+85°C	-40°C~+90°C
IN-P32ATG	Green	90	30				
IN-P32AT5UW	White	90	25				

**Notes**

1. Condition for I<sub>FP</sub> is pulse of 1/10 duty and 0.1msec width

**ESD Precaution**

ATTENTION: Electrostatic Discharge (ESD) protection



The symbol above denotes that ESD precaution is needed. ESD protection for GaP and AlGaAs based chips is necessary even though they are relatively safe in the presence of low static-electric discharge. Parts built with AlInGaP, GaN, or/and InGaN based chips are STATIC SENSITIVE devices. ESD precaution must be taken during design and assembly.

If manual work or processing is needed, please ensure the device is adequately protected from ESD during the process.

Please be advised that normal static precautions should be taken in the handling and assembly of this device to prevent damage or degradation which may be induced by electrostatic discharge (ESD).

**Electrical Characteristics**  $T_A = 25^\circ\text{C}$  (Note 1)

Product	Emission Color	$I_F(\text{mA})$	$V_F(\text{V})$		$\lambda(\text{nm})$			Viewing Angel	$I_v(\text{mcd})$
			min	max	$\lambda_D$	$\lambda_P$	$\Delta\lambda$	$2\theta_{1/2}$	typ.
IN-P32ATYG	Yellow Green	20	1.8	2.6	573	576	15	120	110
IN-P32ATY	Yellow	20	1.8	2.6	590	595	15	120	230
IN-P32ATA	Amber	20	1.8	2.4	605	609	17	120	200
IN-P32ATR	Red	20	1.8	2.4	622	628	20	120	285
IN-P32ATB	Blue	20	2.8	3.6	467	473	30	120	600
IN-P32ATG	Green	20	2.8	3.6	521	530	35	120	1800
IN-P32AT5UW	White	5	2.7	3.1	X=0.27 Y=0.26	-	-	120	1000

**Notes**

1. Performance guaranteed only under conditions listed in above tables.

**Chromaticity Bin (for White only)**

Bin Code	CIE-X	CIE-Y	Bin Code	CIE-X	CIE-Y	Bin Code	CIE-X	CIE-Y	Bin Code	CIE-X	CIE-Y
A5	0.2545	0.2480	B1	0.2640	0.2670	C1	0.2830	0.3050	D1	0.2920	0.3060
	0.2589	0.2445		0.2680	0.2623		0.2863	0.2978		0.2935	0.3015
	0.2680	0.2623		0.2772	0.2800		0.2923	0.3052		0.2997	0.3088
	0.2640	0.2670		0.2735	0.2860		0.2895	0.3134		0.2984	0.3133
A6	0.2589	0.2445	B2	0.2720	0.2575	C2	0.2863	0.2978	D2	0.2935	0.3015
	0.2633	0.2410		0.2680	0.2623		0.2895	0.2905		0.2950	0.2970
	0.2720	0.2575		0.2772	0.2800		0.2950	0.2970		0.3009	0.3042
	0.2680	0.2623		0.2808	0.2740		0.2923	0.3052		0.2997	0.3088
A7	0.2677	0.2375	B3	0.2720	0.2575	C3	0.2895	0.2905	D3	0.2950	0.2970
	0.2633	0.2410		0.2760	0.2528		0.2928	0.2833		0.2965	0.2925
	0.2720	0.2575		0.2844	0.2680		0.2977	0.2891		0.3023	0.2990
	0.2760	0.2528		0.2808	0.2740		0.2950	0.2970		0.3009	0.3042
A8	0.2720	0.2340	B4	0.2760	0.2528	C4	0.2928	0.2833	D4	0.2965	0.2925
	0.2677	0.2375		0.2844	0.2680		0.2977	0.2891		0.2980	0.2880
	0.2760	0.2528		0.2880	0.2620		0.3003	0.2812		0.3037	0.2937
	0.2800	0.2480		0.2800	0.2480		0.2960	0.2760		0.3023	0.2990
E1	0.2984	0.3133	B5	0.2735	0.2860	C5	0.2883	0.3172	D5	0.2937	0.3312
	0.2997	0.3088		0.2772	0.2800		0.2870	0.3210		0.2950	0.3266
	0.3058	0.3160		0.2863	0.2978		0.2937	0.3312		0.3017	0.3360
	0.3048	0.3207		0.2830	0.3050		0.2950	0.3266		0.3005	0.3415
E2	0.2997	0.3088	B6	0.2772	0.2800	C6	0.2883	0.3172	D6	0.2950	0.3266
	0.3009	0.3042		0.2808	0.2740		0.2950	0.3266		0.2962	0.3220
	0.3068	0.3113		0.2895	0.2905		0.2962	0.3220		0.3028	0.3304
	0.3058	0.3160		0.2863	0.2978		0.2895	0.3134		0.3017	0.3360
E3	0.3009	0.3042	B7	0.2808	0.2740	C7	0.2895	0.3134	D7	0.2962	0.3220
	0.3023	0.2990		0.2844	0.2680		0.2908	0.3097		0.2973	0.3177
	0.3081	0.3053		0.2928	0.2833		0.2973	0.3177		0.3038	0.3256
	0.3068	0.3113		0.2895	0.2905		0.2962	0.3220		0.3028	0.3304
E4	0.3023	0.2990	B8	0.2844	0.2680	C8	0.2908	0.3097	D8	0.2973	0.3177
	0.3037	0.2937		0.2928	0.2833		0.2920	0.3060		0.2984	0.3133
	0.3093	0.2993		0.2960	0.2760		0.2984	0.3133		0.3048	0.3207
	0.3081	0.3053		0.2880	0.2620		0.2973	0.3177		0.3038	0.3256
Z2	0.25	0.251	Z3	0.26	0.271	Z4	0.27	0.291	Z5	0.28	0.311
	0.26	0.271		0.27	0.291		0.28	0.311		0.2871	0.321
	0.264	0.267		0.2735	0.286		0.283	0.305		0.2895	0.3134
	0.2545	0.248		0.264	0.267		0.2735	0.286		0.283	0.305
A1	0.2497	0.2267	A2	0.2497	0.2267	A3	0.2593	0.2223	A4	0.2640	0.2200
	0.245	0.229		0.2589	0.2445		0.2677	0.2375		0.2593	0.2223
	0.2545	0.248		0.2633	0.241		0.2633	0.2410		0.2677	0.2375
	0.2589	0.2445		0.2545	0.2245		0.2545	0.2245		0.2720	0.2340
Z1	0.24	0.231									
	0.25	0.251									
	0.2545	0.248									
	0.245	0.2291									

Chromaticity Bin

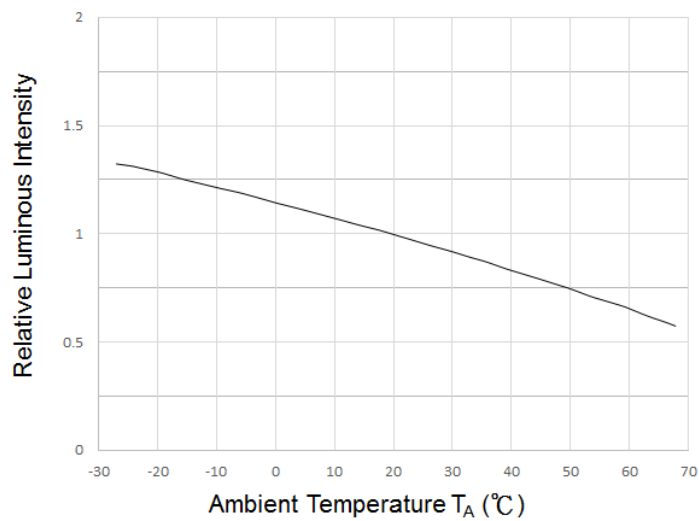
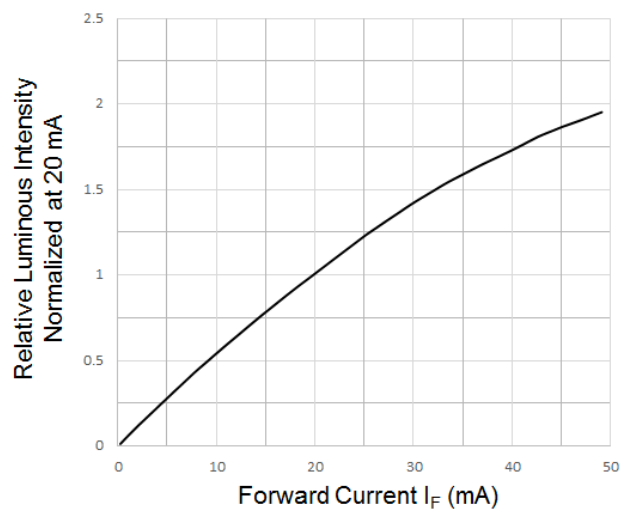
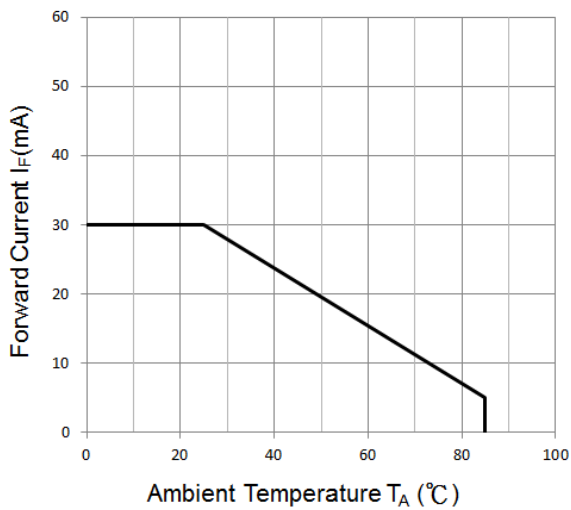
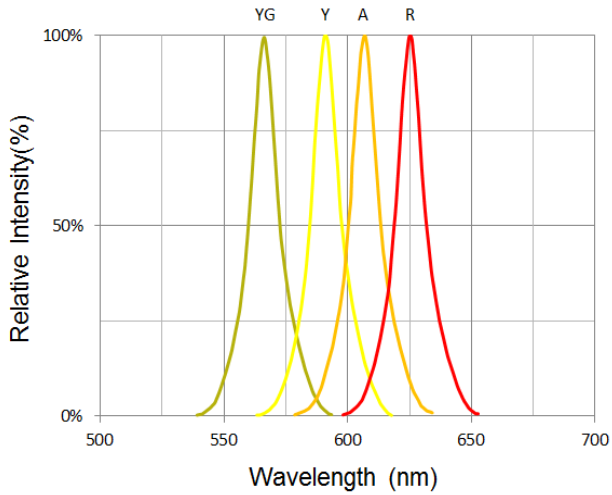

**Typical Characteristic Curves – YG, Y, A, R**

### Typical Characteristic Curves – B, G, W

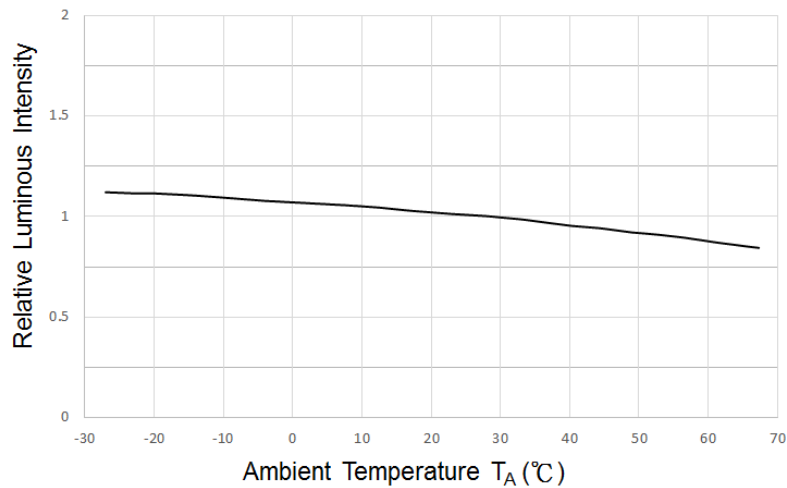
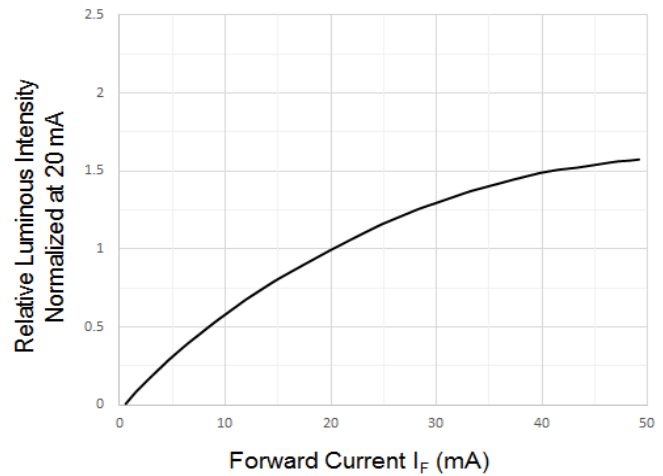
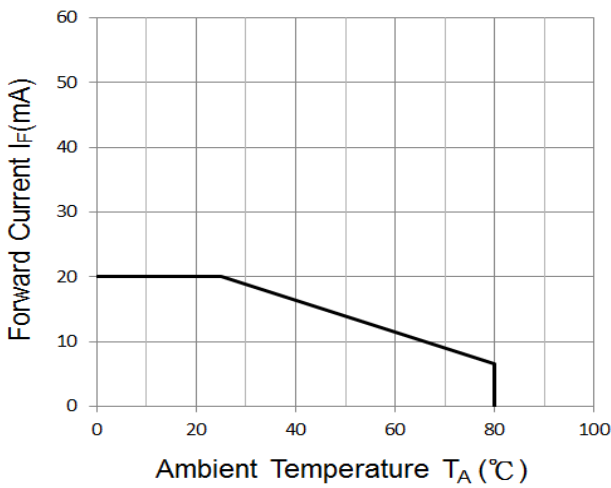
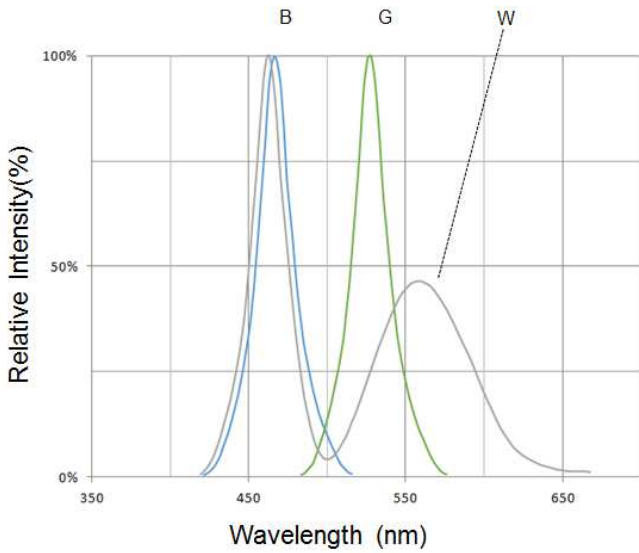

### Typical Characteristic Curves – Radiation Pattern

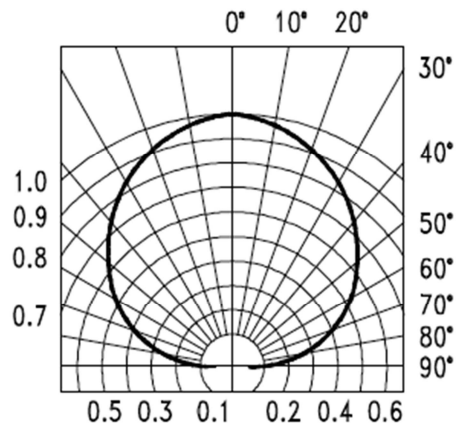

### Ordering Information

Product	Emission Color	Technology	Test Current $I_F$ (mA)	Luminous Intensity $I_v$ (mcd) (Typ.)	Forward Voltage $V_F$ (V) (Typ.)	Orderable Part Number
IN-P32ATYG	Yellow Green	AlInGaP	20	110	2.2	IN-P32ATYG
IN-P32ATY	Yellow	AlInGaP	20	230	2.2	IN-P32ATY
IN-P32ATA	Amber	AlInGaP	20	200	2.0	IN-P32ATA
IN-P32ATR	Red	AlInGaP	20	285	2.0	IN-P32ATR
IN-P32ATB	Blue	InGaN	20	600	3.1	IN-P32ATB
IN-P32ATG	Green	InGaN	20	1800	3.1	IN-P32ATG
IN-P32AT5UW	White	InGaN	5	1000	2.9	IN-P32AT5UW



### Label Specifications



### Inolux P/N:

I	N	-	P	3	2	A	T			X	-	X	X	X	X
Inolux			Material	Package	Variation	Orientation	Current	Lens	Color			Customized Stamp-off			
			P = PLCC Type	32A = 3.5 x 2.8 x 1.9mm		T = Top Mount	(Blank) = 20mA 5=5mA	(Blank) = Clear U = Diffused	R=628nm A=609nm Y=595nm YG=576nm G=530nm B=473nm W=White						

### Lot No.:

Z	2	0	1	7	01	24	001
Internal Tracker	Year (2017, 2018, .....)				Month	Date	Serial

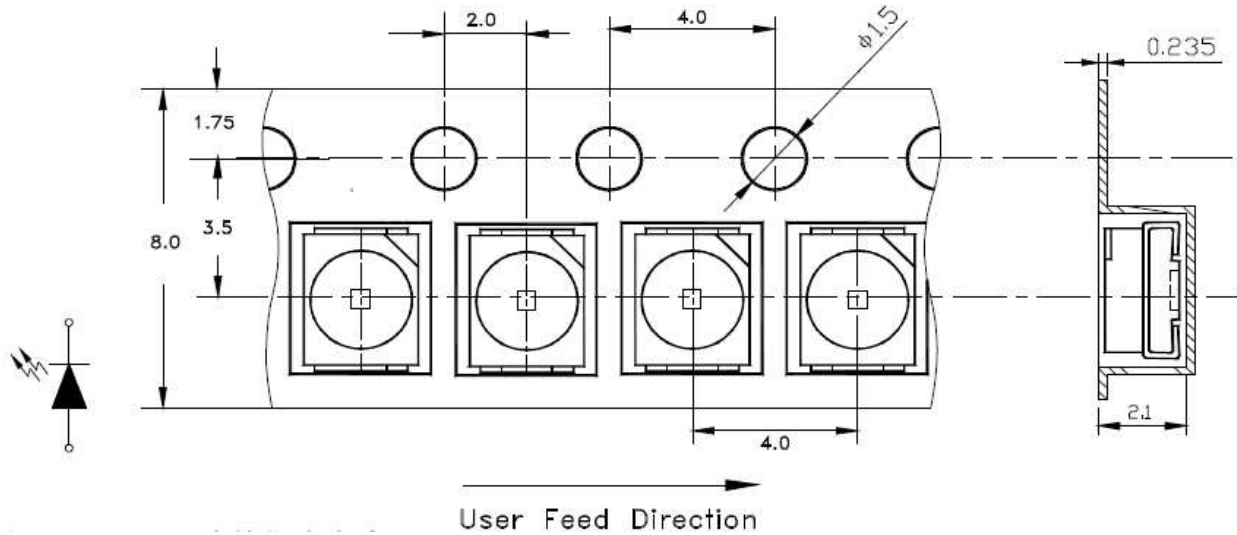
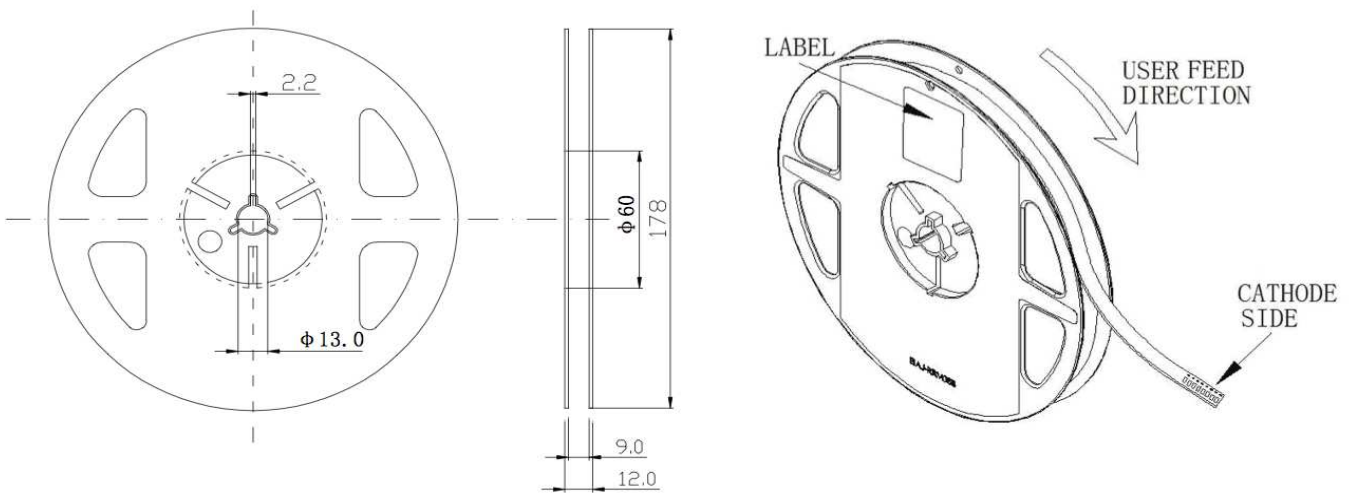
**Packaging Information: 2000pcs Per Reel**
**Tape Dimension**

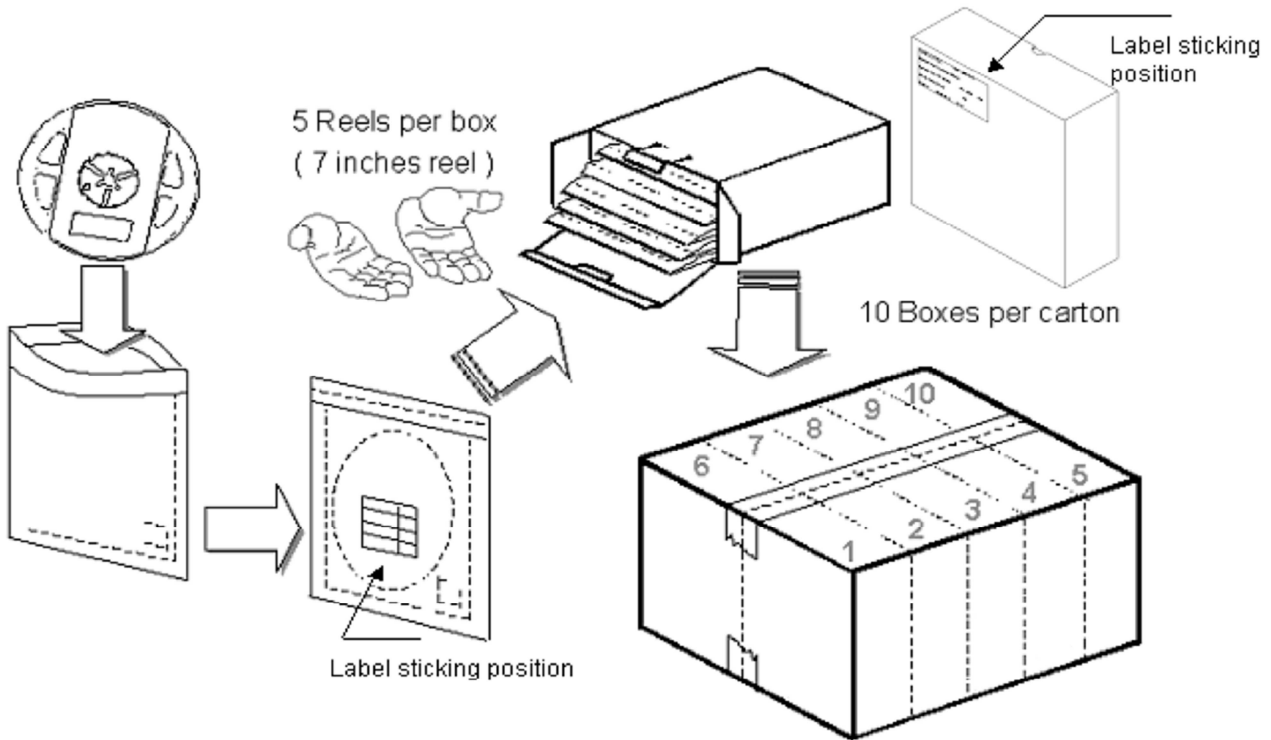
**Reel Dimension**

**Packing Dimension**

5 boxes per carton are available depending on shipment quantity.

	Specification	Material	Quantity
Carrier tape	Per EIA 481-1A specs	Conductive black tape	2000pcs per reel
Reel	Per EIA 481-1A specs	Conductive black	
Label	IN standard	Paper	
Packing bag	220x240mm	Aluminum laminated bag/ no-zipper	One reel per bag
Carton	IN standard	Paper	Non-specified

**Others:**

Each immediate box consists of 5 reels. The 5 reels may not necessarily have the same lot number or the same bin combinations of  $I_v$ ,  $\lambda_D$  and  $V_f$ . Each reel has a label identifying its specification; the immediate box consists of a product label as well.

## Dry Pack

All SMD optical devices are **MOISTURE SENSITIVE**. Avoid exposure to moisture at all times during transportation or storage. Every reel is packaged in a moisture protected anti-static bag. Each bag is properly sealed prior to shipment.

Upon request, a humidity indicator will be included in the moisture protected anti-static bag prior to shipment.

The packaging sequence is as follows:

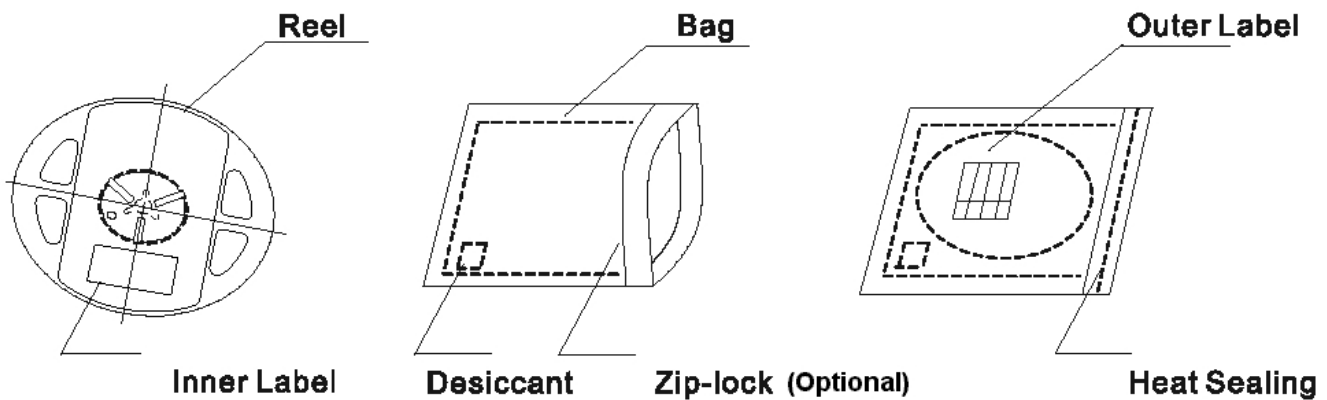

## Reflow Soldering

- Recommended tin glue specifications: melting temperature in the range of 178~192°C
- The recommended reflow soldering profile is as follows (temperatures indicated are as measured on the surface of the LED resin):

Lead-free Solder Profile

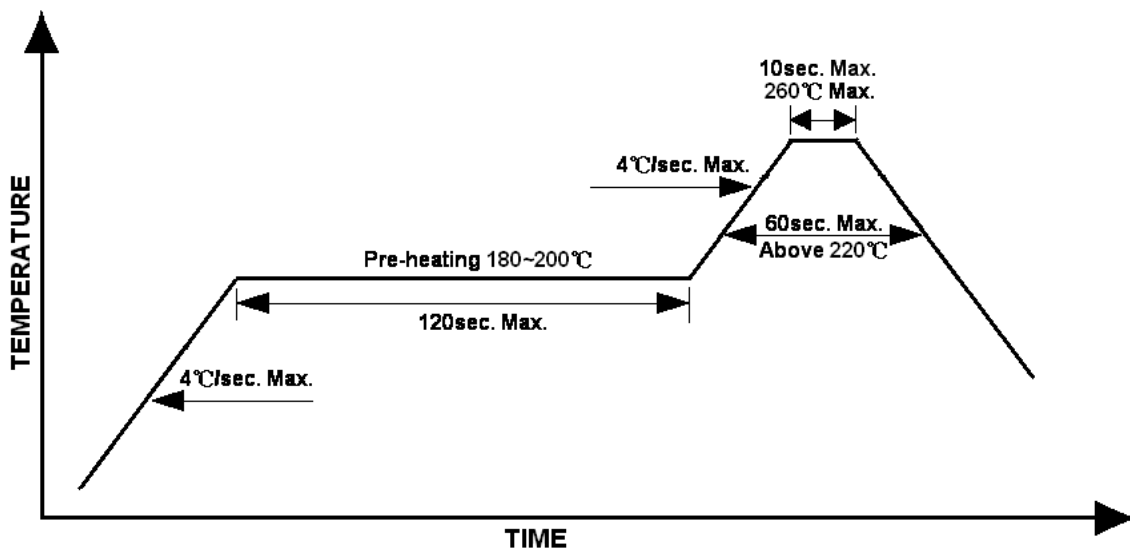

## Precautions

- Avoid exposure to moisture at all times during transportation or storage.
- Anti-Static precaution must be taken when handling GaN, InGaN, and AlInGaP products.
- It is suggested to connect the unit with a current limiting resistor of the proper size. Avoid applying a reverse voltage.
- Avoid operation beyond the limits as specified by the absolute maximum ratings.
- Avoid direct contact with the surface through which the LED emits light.
- If possible, assemble the unit in a clean room or dust-free environment.

## Reworking

- Rework should be completed within 5 seconds under 260 °C.
- The iron tip must not come in contact with the copper foil.
- Twin-head type is preferred.

## Cleaning

Following are cleaning procedures after soldering:

- An alcohol-based solvent such as isopropyl alcohol (IPA) is recommended.
- Temperature x Time should be 50°C x 30sec. or <30°C x 3min
- Ultra sonic cleaning: < 15W/ bath; bath volume ≤ 1liter
- Curing: 100 °C max, <3min

## Cautions of Pick and Place

- Avoid stress on the resin at elevated temperature.
- Avoid rubbing or scraping the resin by any object.
- Electro-static may cause damage to the component. Please ensure that the equipment is properly grounded. Use of an ionizer fan is recommended.

**Reliability**

Item	Frequency/ lots/ samples/ failures	Standards Reference	Conditions
Precondition	For all reliability monitoring tests according to JEDEC Level 2	J-STD-020	1.) Baking at 85°C for 24hrs 2.) Moisture storage at 85°C/ 60% R.H. for 168hrs
Solderability	1Q/ 1/ 22/ 0	JESD22-B102-B And CNS-5068	Accelerated aging 155°C/ 24hrs Tinning speed: 2.5+0.5cm/s Tinning: A: 215°C/ 3+1s or B: 260°C/ 10+1s
Resistance to soldering heat		CNS-5067	Dipping soldering terminal only Soldering bath temperature A: 260+/-5°C; 10+/-1s B: 350+/-10°C; 3+/-0.5s
Operating life test	1Q/ 1/ 40/ 0	CNS-11829	1.) Precondition: 85°C baking for 24hrs 85°C/ 60%R.H. for 168hrs 2.) Tamb25°C; IF=20mA; duration 1000hrs
High humidity, high temperature bias	1Q/ 1/ 45/ 0	JESD-A101-B	Tamb: 85°C Humidity: 85% R.H., IF=5mA Duration: 1000hrs
High temperature bias	1Q/ 1/ 20	IN specs.	Tamb: 55°C IF=20mA Duration: 1000hrs
Pulse life test	1Q/ 1/ 40/ 0		Tamb25°C, If=20mA, Ip=100mA, Duty cycle=0.125 (tp=125 μs, T=1sec) Duration 500hrs)
Temperature cycle	1Q/ 1/ 76/ 0	JESD-A104-A IEC 68-2-14, Nb	A cycle: -40 degree C 15min; +85 degree C 15min Thermal steady within 5 min.. 300 cycles 2 chamber/ Air-to-air type
High humidity storage test	1Q/ 1/ 40/ 0	CNS-6117	60+3°C 90+5/-10% R.H. for 500hrs
High temperature storage test	1Q/ 1/ 40/ 0	CNS-554	100+10°C for 500hrs
Low temperature storage test	1Q/ 1/ 40/ 0	CNS-6118	-40+5°C for 500hrs

## Revision History

Changes since last revision	Page	Version No.	Revision Date
Initial Release		1.0	02-21-2017

## DISCLAIMER

INOLUX reserves the right to make changes without further notice to any products herein to improve reliability, function or design. INOLUX does not assume any liability arising out of the application or use of any product or circuit described herein; neither does it convey any license under its patent rights, nor the rights of others.

## LIFE SUPPORT POLICY

INOLUX's products are not authorized for use as critical components in life support devices or systems without the express written approval of the President of INOLUX or INOLUX CORPORATION. As used herein:

1. Life support devices or systems are devices or systems which, (a) are intended for surgical implant into the body, or (b) support or sustain life, and (c) whose failure to perform when properly used in accordance with instructions for use provided in the labeling, can be reasonably expected to result in a significant injury of the user.
2. A critical component in any component of a life support device or system whose failure to perform can be reasonably expected to cause the failure of the life support device or system, or to affect its safety or effectiveness.

Компания «Океан Электроники» предлагает заключение долгосрочных отношений при поставках импортных электронных компонентов на взаимовыгодных условиях!

Наши преимущества:

- Поставка оригинальных импортных электронных компонентов напрямую с производств Америки, Европы и Азии, а так же с крупнейших складов мира;
- Широкая линейка поставок активных и пассивных импортных электронных компонентов (более 30 млн. наименований);
- Поставка сложных, дефицитных, либо снятых с производства позиций;
- Оперативные сроки поставки под заказ (от 5 рабочих дней);
- Экспресс доставка в любую точку России;
- Помощь Конструкторского Отдела и консультации квалифицированных инженеров;
- Техническая поддержка проекта, помощь в подборе аналогов, поставка прототипов;
- Поставка электронных компонентов под контролем ВП;
- Система менеджмента качества сертифицирована по Международному стандарту ISO 9001;
- При необходимости вся продукция военного и аэрокосмического назначения проходит испытания и сертификацию в лаборатории (по согласованию с заказчиком);
- Поставка специализированных компонентов военного и аэрокосмического уровня качества (Xilinx, Altera, Analog Devices, Intersil, Interpoint, Microsemi, Actel, Aeroflex, Peregrine, VPT, Syfer, Eurofarad, Texas Instruments, MS Kennedy, Miteq, Cobham, E2V, MA-COM, Hittite, Mini-Circuits, General Dynamics и др.);

Компания «Океан Электроники» является официальным дистрибьютором и эксклюзивным представителем в России одного из крупнейших производителей разъемов военного и аэрокосмического назначения «JONHON», а так же официальным дистрибьютором и эксклюзивным представителем в России производителя высокотехнологичных и надежных решений для передачи СВЧ сигналов «FORSTAR».



## JONHON

«JONHON» (основан в 1970 г.)

Разъемы специального, военного и аэрокосмического назначения:

(Применяются в военной, авиационной, аэрокосмической, морской, железнодорожной, горно- и нефтедобывающей отраслях промышленности)

«FORSTAR» (основан в 1998 г.)

ВЧ соединители, коаксиальные кабели, кабельные сборки и микроволновые компоненты:

(Применяются в телекоммуникациях гражданского и специального назначения, в средствах связи, РЛС, а так же военной, авиационной и аэрокосмической отраслях промышленности).



Телефон: 8 (812) 309-75-97 (многоканальный)

Факс: 8 (812) 320-03-32

Электронная почта: [ocean@oceanchips.ru](mailto:ocean@oceanchips.ru)

Web: <http://oceanchips.ru/>

Адрес: 198099, г. Санкт-Петербург, ул. Калинина, д. 2, корп. 4, лит. А