

Vision System FH Series

Industry's Fastest Compact Vision System

The Fastest **FH**



» Easy to Integrate in Machines

» Increase Machine Speed

» Perform High-precision Machine Operation

Industry's Fastest* Compact Vision System A New Concept in Image Processing That Considers

It's time to move beyond simply increasing the speed of image processing and start seriously shortening Machine cycle time. This is the concept that gave birth to OMRON's FH-series Vision System and its best-in-the-industry speed.

Manufacturing Machines are operated through the interaction of sensors, PLCs, servomotors, and other devices. Vision Systems measure positions and perform inspections, and the results are used to control the operation of Machines. The demand for faster, more precise Vision System operation is the primary requirement. The FH-series Vision System provides higher speed and precision for Machine cycle time and is loaded with all of the performance required to move Machines quickly and at high precision into a compact Controller for embedding into Machine. And even though the Camera/communications interfaces, image processing algorithms, and other features of this complete image processing system are built into one housing, the flexibility of a PC-based image processing system is also provided to help increase efficiency in the frequent reuse of Machine designs and in design changes.

*Based on OMRON investigation in May 2013.



Shorter Machine Cycle Times

Logic control



- Sysmac is a trademark or registered trademark of OMRON corporation in Japan and other countries for OMRON factory automation products.
 - Think&See is a trademark or registered trademark of OMRON Corporation in Japan and other countries.
 - EtherCAT® is registered trademark and patented technology, licensed by Beckhoff Automation GmbH, Germany.
 - Windows, Microsoft® Visual Studio® are either registered trademarks or trademarks of Microsoft Corporation in the United States and/or other countries.
 - The Microsoft .NET software is used to connect users, information, systems, and devices.
 - QR Code is registered trademarks of DENSO WAVE INCORPORATED in Japan and in other countries.
 - Other company names and product names in this document are the trademarks or registered trademarks of their respective companies.
 - The product photographs and figures that are used in this catalog may vary somewhat from the actual products.
- Microsoft product screen shot(s) reprinted with permission from Microsoft Corporation.

Machine Cycle Time

Increase Machine Speed >> p4



- **High-speed Response to Execution Instructions from a PLC**

A high-speed image bus and 4-core CPU processing increase the speed at every step, from image input to data output.

- **Multiple camera inspections provide total judgement results**

Calculations are easy to set for the results from four parallel tasks.

- **Quickly Outputting Measurement Results to a PLC**

You can output results to an NJ-series Machine Automation Controller on an EtherCAT communications cycle of 500 μ s.

Perform High-precision Machine Operation >> p8

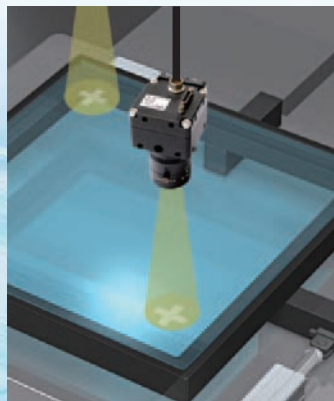

- **Measurements for Out-of-focus or Rotated Images**

The new Shape Search III processing item provides superior stability.

- **No Worker-dependence in Calibration Accuracy**

Vision master calibration is provided.

Easy to Integrate in Machines >> p10

Positioning



- **Shared Machine Interface**

Microsoft® .NET is supported.

- **Display Only Required Menu Commands on the Operation Interface**

User interface customization is supported.

- **Fast Support for Additional Measurement Needs**

Complete processing item libraries are provided.

Process Higher-resolution Images without Increasing the Machine Cycle Time



High-speed Image Input **Fastest: 3.3 ms**

Camera resolution, driven by higher expectations for quality, continues to increase. OMRON has greatly reduced the input time and image transfer time to provide high-speed processing to match the speed of Machine applications for high-resolution images. Even with more Cameras and higher resolution, high-speed image input will contribute to increasing throughput.

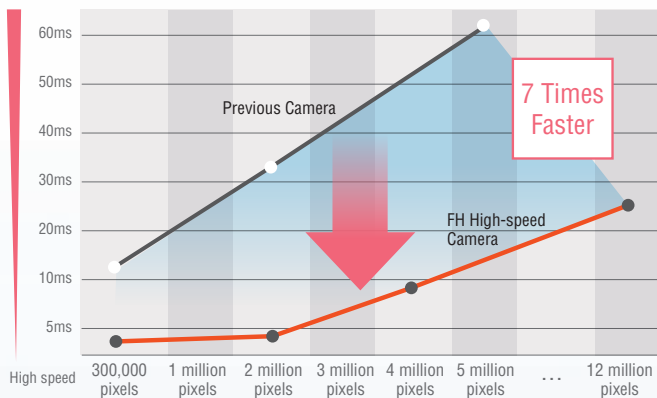

Realtime Image Transfer

High-resolution Cameras capture large amounts of data, which can make a bottleneck out of the transfer speed time in addition to the image input time bottleneck. An FH-series Controller provides a faster, multi-line image bus to enable realtime transfer of large amounts of image data for high-resolution Cameras or multiple Cameras. If high-precision measurements were sacrificed due to speed, the FH Series returns your precision without increasing cycle time.

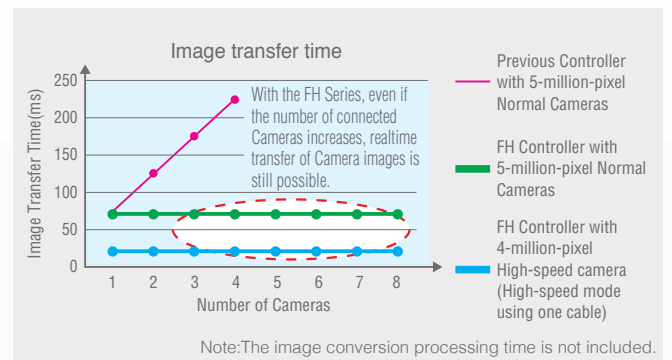

Ultra-high-speed Searching **Shape Search III**

New technology makes search algorithms nine times faster than before. Even for unstable image conditions, including light interference, overlapping shapes, gloss, and incomplete images, stable searching is possible without reducing speed, resulting in a increased stability.

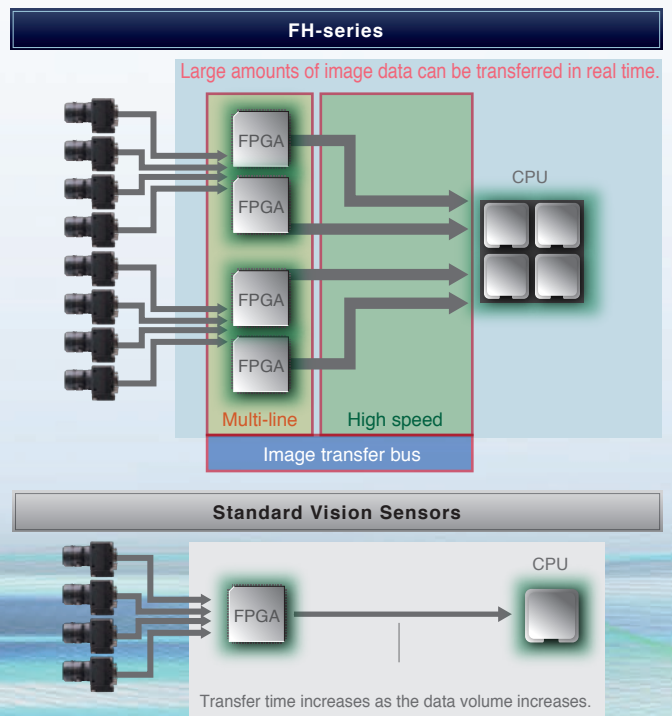
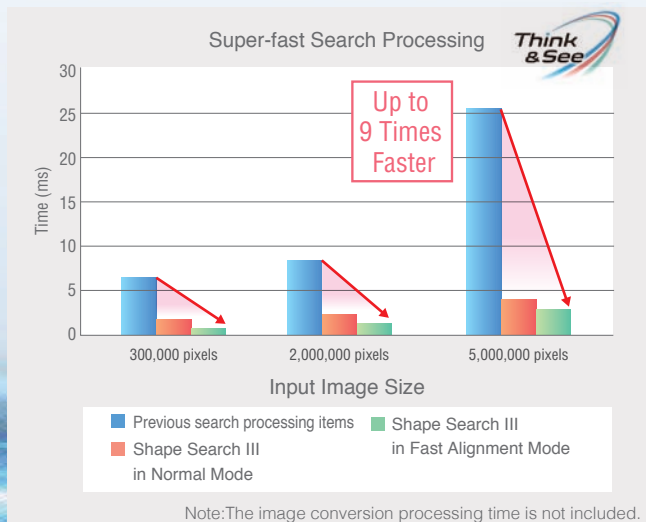

Four-core CPU* to Meet High-speed Demands for Different Machines

*for high speed controllers only

Case1 Perform Calculations for Multiple Cameras without Delay

Even when the measurement results of sequential operations are dependent on the speed of the independent action, parallel processing allows high speed performance without any dwell time. The measurement results from four cores can be easily calculated on one Controller to achieve continuous interaction without any special programming.

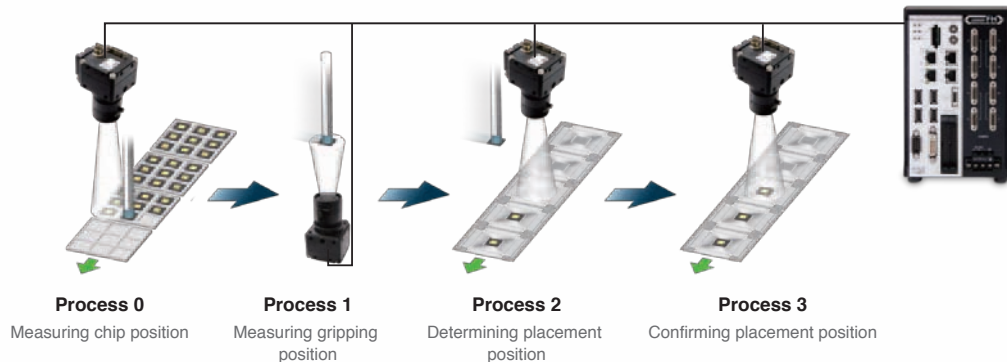

Measuring the Next Workpiece without Waiting Time

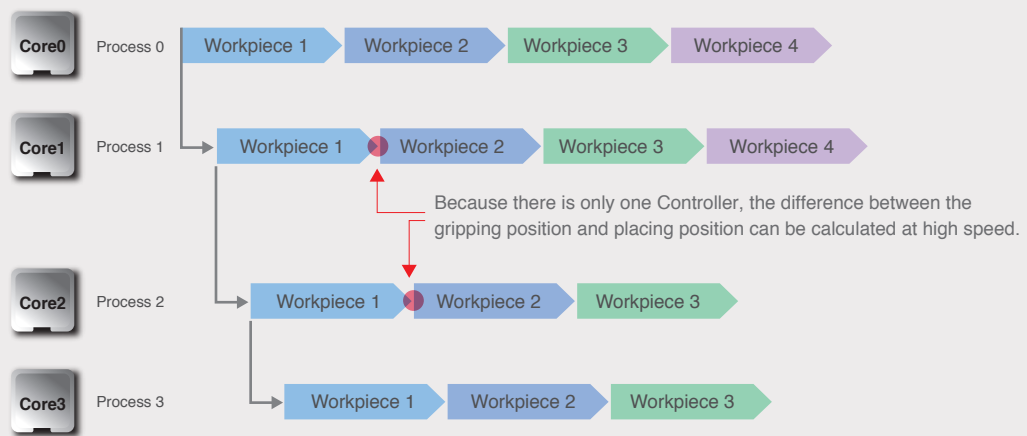

Frequently Waiting for Processing with a Standard Vision Sensor

The lack of the ability for standard Vision Sensors to handle parallel processing creates waiting time everywhere. If the Machine cycle time cannot be increased, a Controller must be added for each process to perform parallel processing, increasing costs.

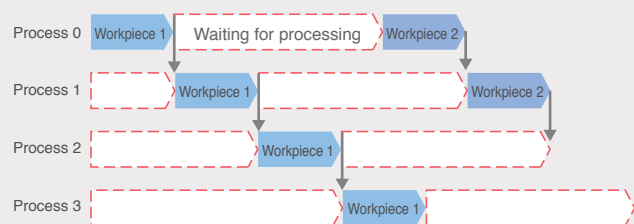

Four-core CPU* to Meet High-speed Demands for Different Machines

*for high speed controllers only

Case2 Machine Cycle Time Reduced to 1/4* of Previous Time

Four cores process triggers, so the trigger interval can be 1/4th* of previous models.

*In-house comparison.

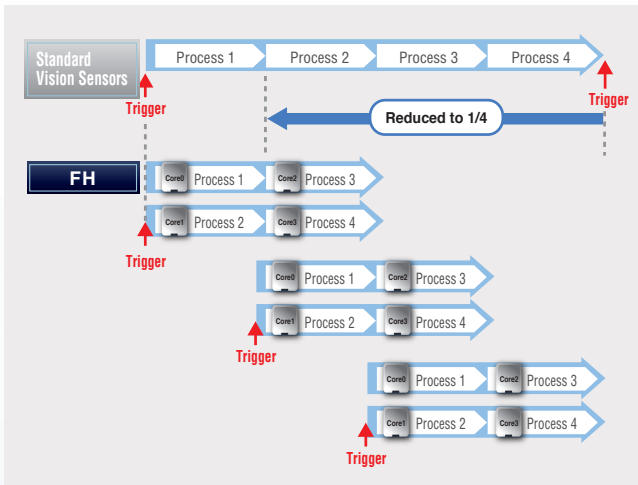
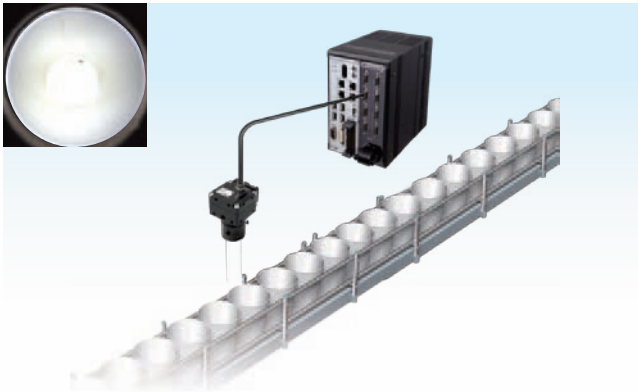

Multi-input Function Continuous High-speed Image Capture

Higher Speed from Advanced Image Capture and Parallel Measurements

Each camera has its own image buffer for storing image data that is separate from the main memory used for measurement processing. This allows for up to 256 frames of continuous high-speed image capture even while the main memory is processing measurement data.

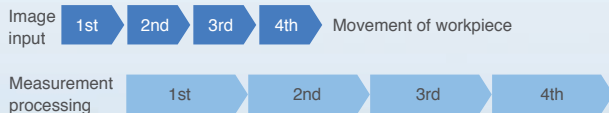

*The number of images that can be captured depends on the Controller and the Camera that is connected to it. Refer to the user's manual for details.

Case3 Process Multiple Lines in Parallel without Any Waiting Time

Four controllers are compressed into one without increasing the line cycle time. You can greatly reduce costs for processes that involve many lines.

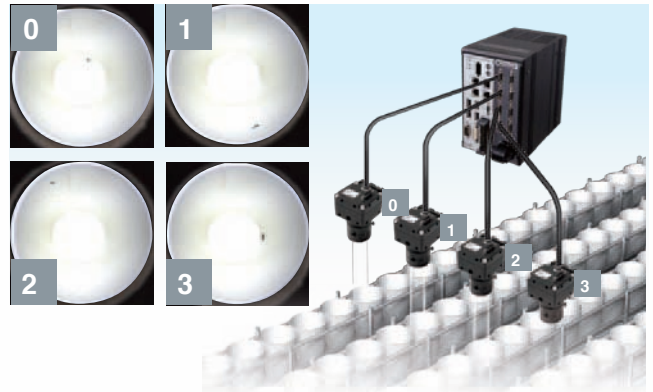

FH-series

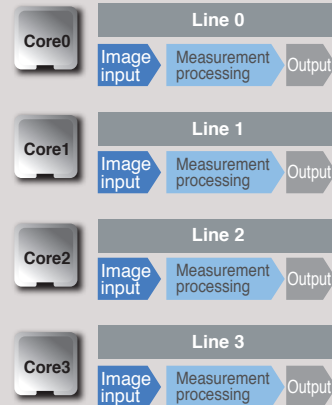

Eliminate the 'Waiting Time' Bottleneck

Standard Vision Sensors

When multiple triggers are input to a standard vision sensor, only image input is performed in parallel, and waiting time occurs when starting measurement processing. This time becomes a bottleneck in terms of the Machine cycle time.

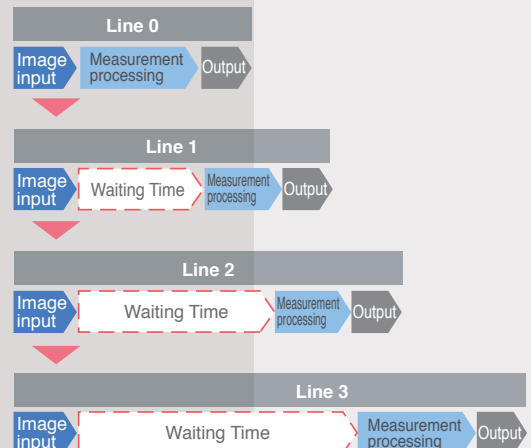

Fast Output of Measurement Results to Reduce Machine Cycle Time

EtherCAT Machine Control Network

EtherCAT is a high-speed open network that is ideal for Machine control. You can use EtherCAT to connect to NJ-series Machine Automation Controllers and motion control G5-series Servomotors and Servo Drives to increase the control speed over everyday communications protocols from workpiece detection to starting axis motion.

■ Features

- Communications cycle as low as 500 μ s
- Motion control that is synchronized with the communications cycle

Communications Cycle

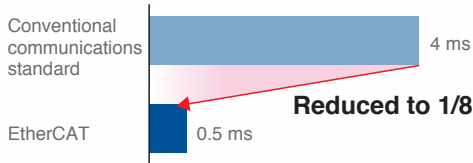

Time from Trigger Input to Producing Measurement Results

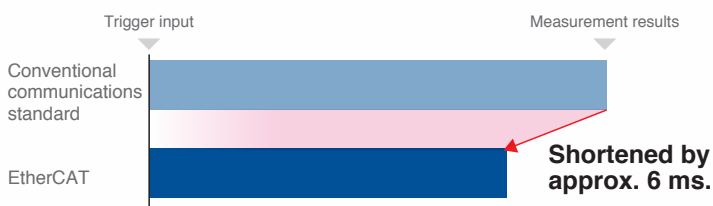

Note: The times given above are typical times. They depend on parameter settings.

Positioning Solution That Eliminates Workpiece Dwell Time: Continuous Alignment Patent Pending

For a Machine that requires micron precision, one alignment is not always enough to obtain an acceptable error level, but executing multiple alignments greatly increases the processing time. OMRON provides control methods that eliminate workpiece dwell time, the main cause of increased processing time. Our Sysmac Automation Platform achieves high-speed, high-precision control that continuously detects workpiece positions and successively updates the travel distance to quickly approach the target position.



[Previous Vision Sensors]

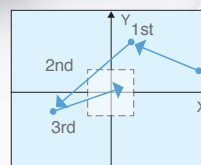
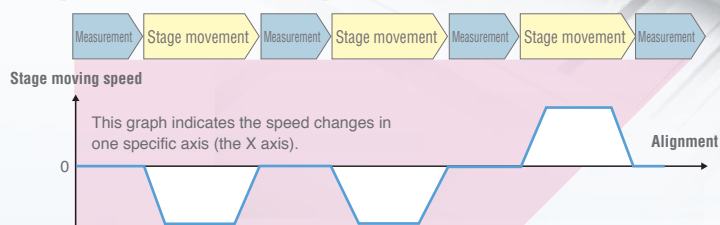

[Sysmac]

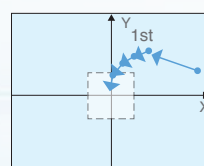
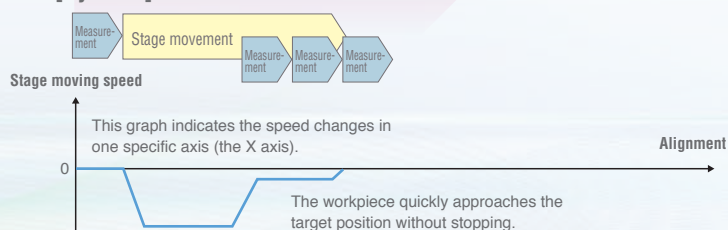

Note: Please ask your OMRON representative for details.

The High-precision Object Detection Required for Positioning

Low-error Position Detection Even with Blurry Images

Over the years, OMRON has perfected techniques to search for and match templates at high speed. From these techniques Shape Search III provides advanced robustness, which is critical on FA sites. When measuring lamination of glass or other processes where the distance to the workpiece from the Camera varies, size differences and focal shifts can occur. Even in cases like this, the new Shape Search III algorithm detects positions with limited error.

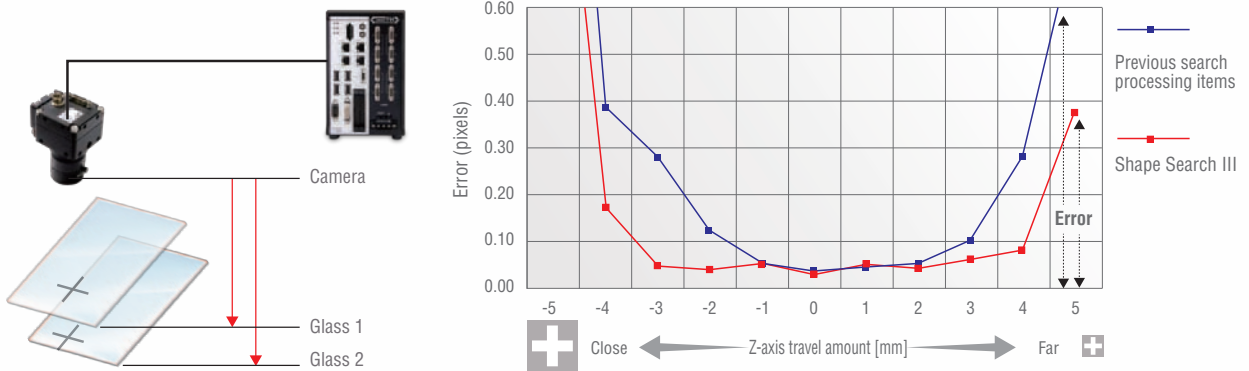

Stable Searching with Limited Error Even under Adverse Conditions

Stable searching is possible even under the following adverse conditions, which occur far too often in actual measurement applications.

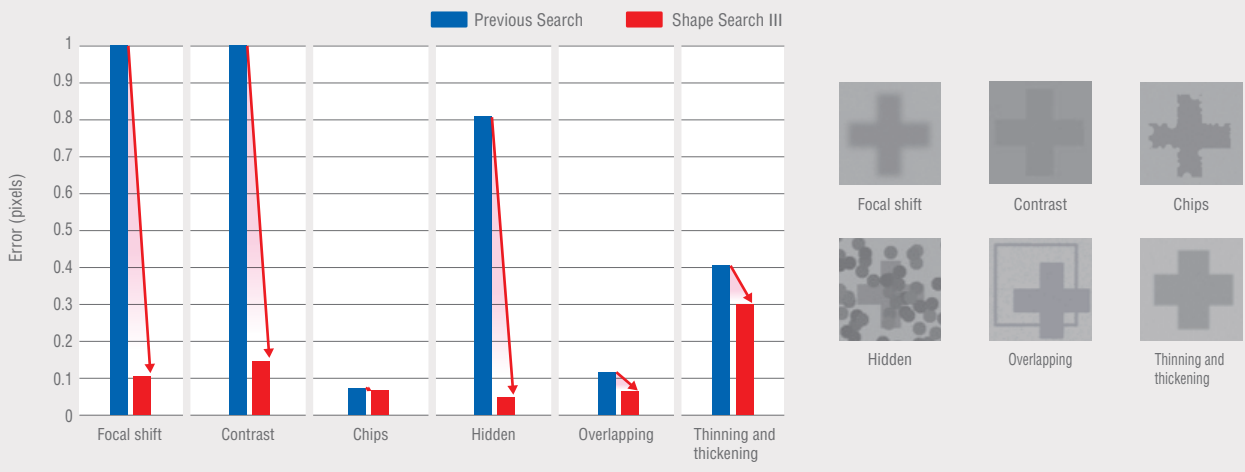

Visualization of Comparisons Enables Easy Setup of High-precision Searching

Patent Pending

Advanced searching is accompanied by many parameters that must be tuned to match the application. However, it is difficult for the person making the settings to see the internal process. Extensive time is required to make the most of tool performance. With Shape Search III, you can visualize comparisons between the model data and a part of the measurement object to easily see when comparisons are not matched well for the inspection. Visualization of the comparison level, allows for parameters to be adjusted simply to obtain the best performance.

The diagram shows a 'Registered model' (a green cross) and a 'Measurement image' (a grey cross). The measurement image has 'Deformation' and a 'Chip' indicated by red dashed circles. A comparison level is shown as a green outline on the measurement image. An arrow points to a second comparison level where the green outline is more closely aligned with the measurement image. Text labels indicate 'Reduction in correlation' and 'No reduction'.

You can see at a glance the difference between the registered model and measurement image.

You can adjust a parameter called the Acceptable Distortion Level to enable measurements without reducing the correlation even if there is distortion. You can easily adjust this parameter while monitoring the comparison.

Converting Measurement Results to Output User Units

Support for the Main Stages and Robots Used for 2D Positioning

The FH Controllers contain special setup displays for the stages and robots that are commonly used on FA sites. You just fill in the settings to easily output axis travel amounts for stages and robots.

User Interface Example

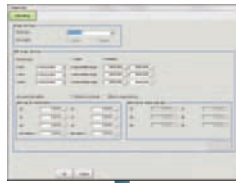

Application Examples

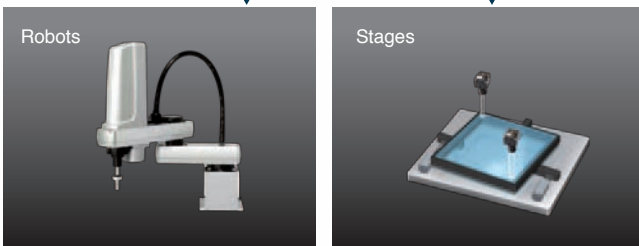

Item			
Stages	XY	θ axis: Direct drive	Camera axis movement: None
			Camera axis movement: X axis
	Camera axis movement: Y axis		
	Camera axis movement: XY axes		
	XYθ	θ axis: Linear drive	Camera axis movement: None
			Camera axis movement: X axis
	Camera axis movement: Y axis		
	Camera axis movement: XY axes		
θXY	θ axis: Direct drive	Camera axis movement: None	
		Camera axis movement: X axis	
	Camera axis movement: Y axis		
	Camera axis movement: XY axes		
θXY	θ axis: Linear drive	Camera axis movement: None	
		Camera axis movement: X axis	
Camera axis movement: Y axis			
Camera axis movement: XY axes			
UVW	Direct fulcrum motion		
	Rotary fulcrum motion		
UVWR	Direct fulcrum motion		
	Rotary fulcrum motion		
Robots	3 axes		
	4 axes	Control method: Measured positions	

Vision Master Calibration for High-precision Positioning Even with Normal Lenses

To perform high-precision positioning, the coordinate system must be accurately aligned between image processing and the stage or robot. Calibration is used to achieve this. Normally trial and error in the actual application environment is necessary, which requires experience in moving sampling points and a experience with the influence of minor tilt in the Camera installation, the influence of lens distortion, and other factors. With an FH Controller, all you need to do is set a minimum number of conditions. Movement patterns for the sampling points are automatically calculated to optimize the stage/robot axis travel ranges, imaging processing field of view, and other factors, and the required axis travel amounts are sent to the PLC. By moving the system according to the instructions, optimum sampling is achieved and the coordinate systems for image processing and the stage/robot are accurately aligned. Correction coefficients are simultaneously calculated for Camera tilt and lens distortion. If you use the calibration conversion parameters that are made with this function, you can easily achieve high-precision positioning even for normal lenses with high distortion rates.

> Page 15: Setup Flow for Vision Master Calibration

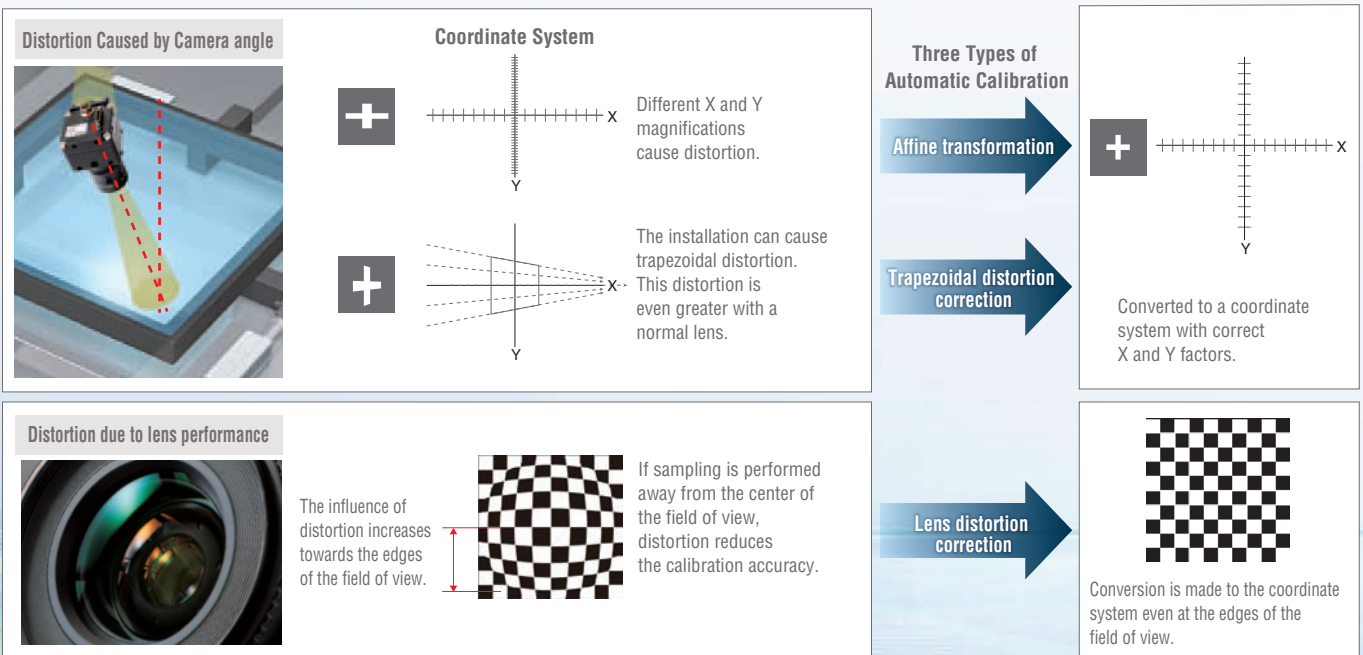

Easily Integrate Interfaces into the Machine

Easy Integration into a Machine Monitor Support for .NET User Interface Controls

Custom .NET controls are supported so that you can easily display FH Controller measurement images and measurement results on a Machine PC.

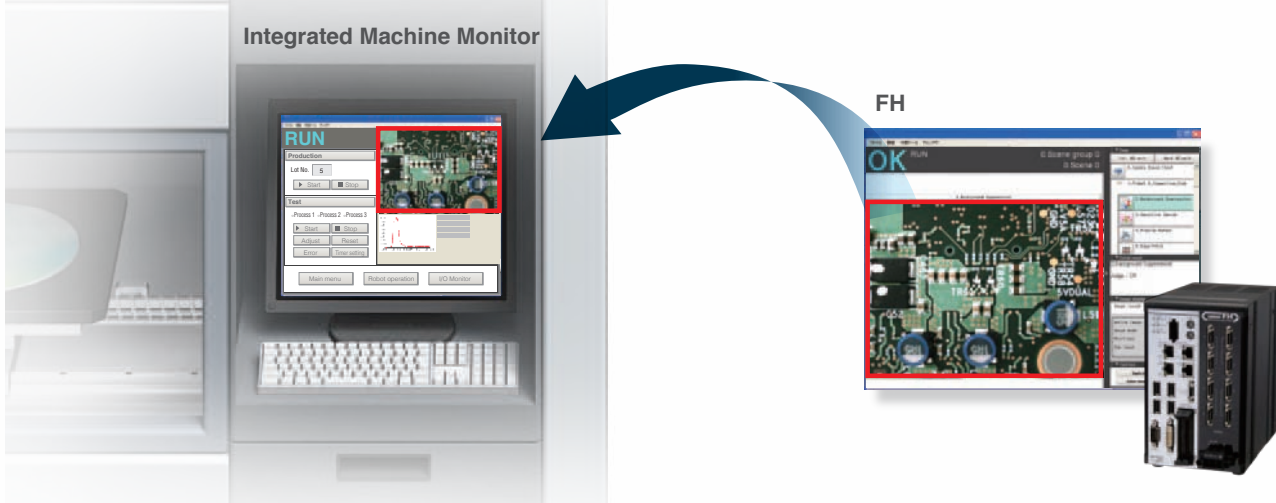

Easy Customization

① Custom controls for FH measurement images and measurement results are laid out on Microsoft Visual Studio®.

② Instead of writing the program code from scratch to build interfaces, you can easily build the interfaces simply by pasting custom controls.



Easy Setting and Operation Using a Touch Pen

NEW

The Touch Panel Monitor FH-MT12 has been added to the FH Series. The FH-MT12 is equipped with a 12.1-inch screen that is ideal for replacement of existing models. You can adjust all the settings by touching the screen.

- 12.1 inch XGA
- Panel mountable
- VESA mountable



Design the Connected Components with One Software Application

Develop Machine Control Programs with One Software Application: Sysmac Studio

Use the Automation Software Sysmac Studio to set up all of the slaves connected via EtherCAT. Simulate and debug motion control, logic, drives, and sensing on an integrated platform to reduce the work required for Machine design.

One Software



Sysmac Studio version 1.07 or higher supports the FH Series.



NJ-series
Machine Automation Controller



FH-series
Vision System



G5-series
Servomotors and Servo Drives

Minimize Commissioning and Adjustment Work with Simulations

Integrated simulations linked to an NJ-series Machine Automation Controller lets you verify the NJ-series program logic and check how the FH-series Vision System responds to each control signal. You can directly edit the EtherCAT I/O map to send measurement commands to the FH-series Vision System.

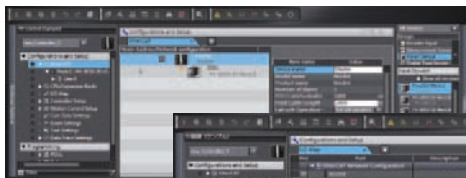

EtherCAT
Configuration
Window

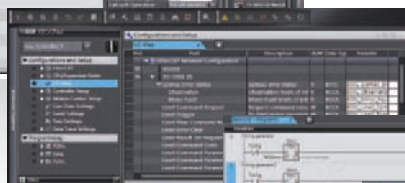

I/O Map Window

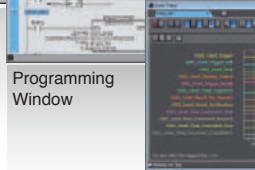

Programming
Window

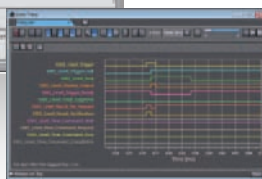

Data Trace Window

Easy Setup with Program Scalability

Customize Original Operation Interfaces

Show only the buttons you need

Choose from our library of buttons and position them anywhere on-screen to best support your daily operation, without 'screen clutter'.

Arrange the Interface Elements Flexibly

You can flexibly change the image display composition to display an entire image, enlarge part of an image, or display images from different Cameras.

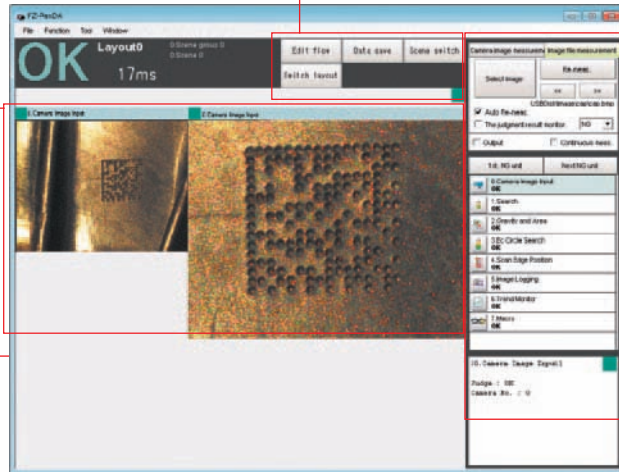

Move windows freely

Drag and drop windows where you want. You can also change the box size and delete.

Nine screen layout

Up to 9 screens can be stored depending on the application or user classification.

Hide Unnecessary Adjustment Commands

With only menu operations on the Controller, you can customize the setting displays in dialog boxes for processing items. For example, you can set up the interface to hide any parameters from the operator.

Freely Lay Out Dialog Box Contents

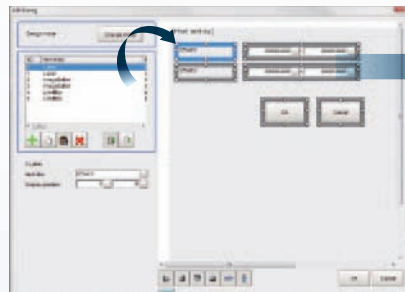

Completed



Only a parameter required for daily operation can be displayed.

Completely Different Operation Interfaces for the Designer and Operator

Accounts can be used to keep completely different operation interfaces for the designer and the operator. You can set up to eight levels of security for up to 50 items for each account. You can record operation logs for each account to enable smoothly isolating problems when troubleshooting.

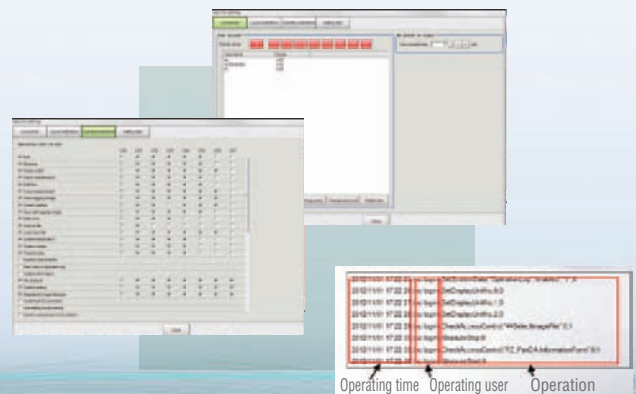

Flow Viewer Builds the Measurement Process with Flow Chart Programming

Just add any of the large variety of processing items to the measurement flow to build the basic program for image processing.

All processing items have menus for easy setup and adjustment.

Easily build the best imaging processing for each application to smoothly complete testing and adjustments without programming.

Flowchart

Just add processing items from the processing item list to visually edit the flow.

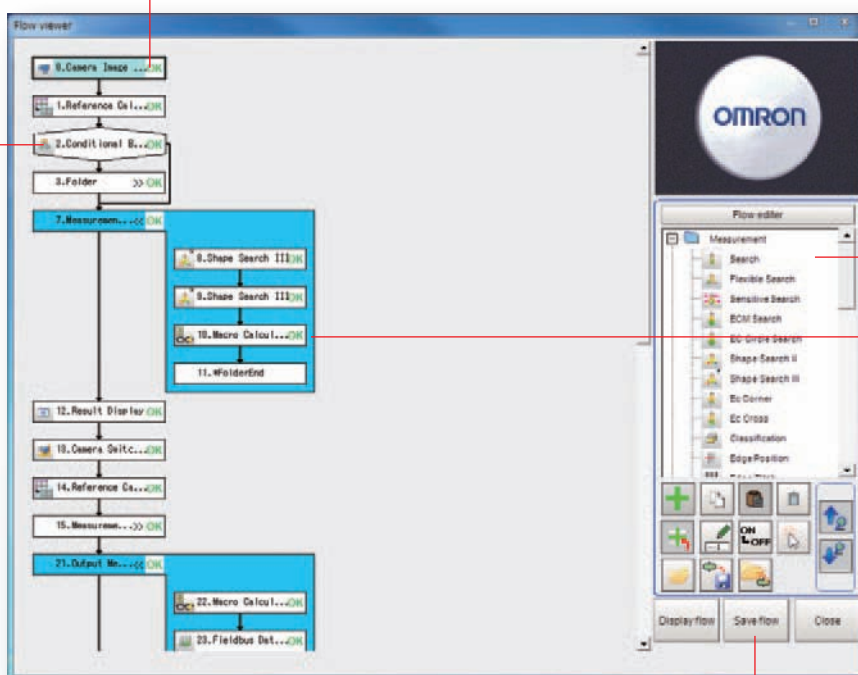

Processing Item List

Folders

You can group processing units into named folders. By managing related processing together and hiding lower levels, you can display even long measurement flows in a way that easily shows the overall flow.

Flowchart Output

You can save the flowchart as an image file.

Branching

You can use conditional branching to branch according to the execution results of the previous processing units or you can use branching controls with external commands through parallel I/O, PLC Links, or no-protocol communications.

>Page 25: Controlling Flow Branching Conditions from an External Device.

Easy Multi-language Support: Change between 9 Languages

You can change display messages between nine different languages: Japanese, English, Chinese (traditional or simplified), German, French, Italian, Spanish, and Korean. You can display the best language for the user for applications in other countries.

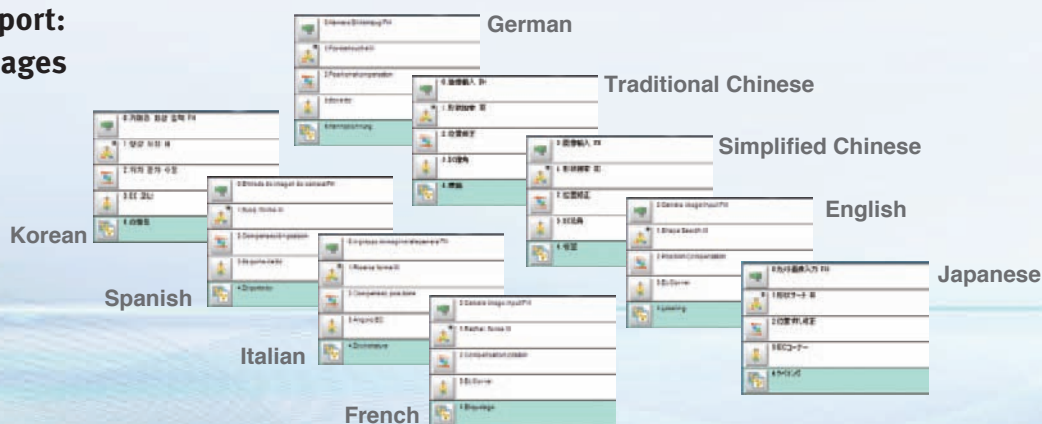

High-precision Alignment Library

Alignment Calculations

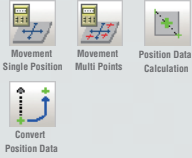

Four specialized processing items for alignment calculations are supported. These can be combined to easily execute alignments that require complex calculations on previous systems models or computers.

Movement Single Position

The axis movement that is required to match the measured position angle to the reference position angle is calculated.

Convert Position Data

The position angle after the specified axis movement is calculated.

Movement Multi Points

The axis movements that are required to match the measured position angles to the corresponding reference position angles are calculated.

Position Data Calculation

The specified position angle is calculated from the measured position.

Examples of Available Alignments

Alignment Using Positions and Angles

The alignment based on positions and angles using the Movement Single Position processing item is available to align the positions of workpieces with different sizes. This alignment allows the use of offsets to achieve flexible positioning.

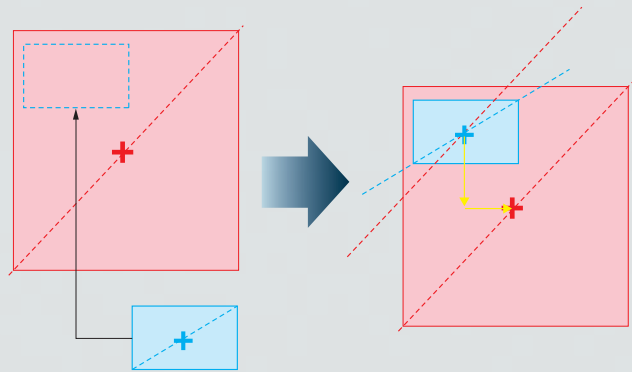

Alignment with Side Measurements

This alignment method measures the sides of the workpiece using the Movement Multi Points processing item. You can use this method to position the workpiece without alignment marks or when its corners cannot be measured.

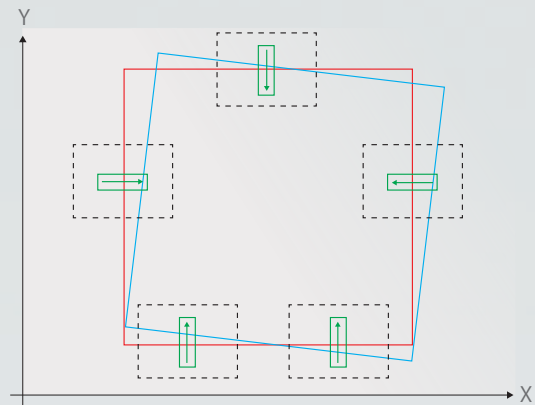

Alignment Using Corresponding Points

The Movement Multi Points processing item is used for alignment based on relational positions.

This method is used to align the respective positions on substrates.

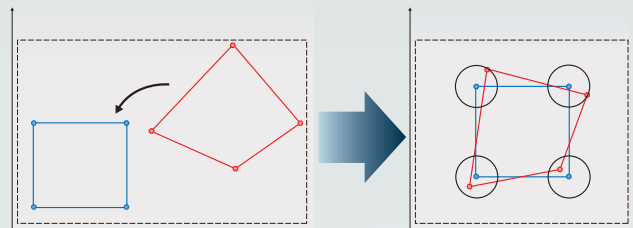

Setup Aids

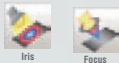

Optimum Focus and Aperture Settings

Until now, focus and brightness settings were adjusted according to experience and intuition. But now they can be evaluated numerically and visually on graphs. This allows quick verification of optimum focus and aperture settings to eliminate inconsistencies in settings caused by worker differences so that you can achieve even higher levels of measurement accuracy.

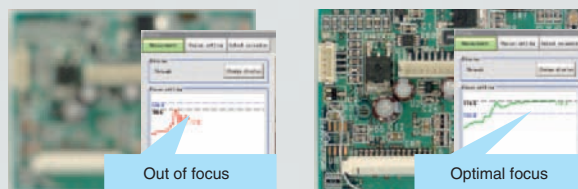

- Camera installation and setup are easy.
- Errors can be generated when the focus or aperture changes.
- You can determine the numerical values for the focus and aperture for the master workpiece so that essentially anyone can reproduce the same conditions.

Calibration

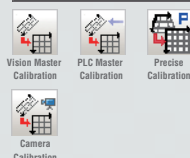

Vision Master Calibration

With Vision Master Calibration, the FH-series Vision System automatically calculates the movement patterns for sampling points to optimize the stage/robot axis travel ranges, imaging processing field of view, and other factors, and the required axis movements are sent to the PLC. By moving the system accordingly, optimum sampling is achieved and the coordinate systems for image processing and the stage/robot are accurately aligned. Correction coefficients are simultaneously calculated for Camera tilt and lens distortion. If you use the calibration conversion parameters that are made with this function, you can easily achieve high-precision positioning even for normal lenses with high distortion rates.

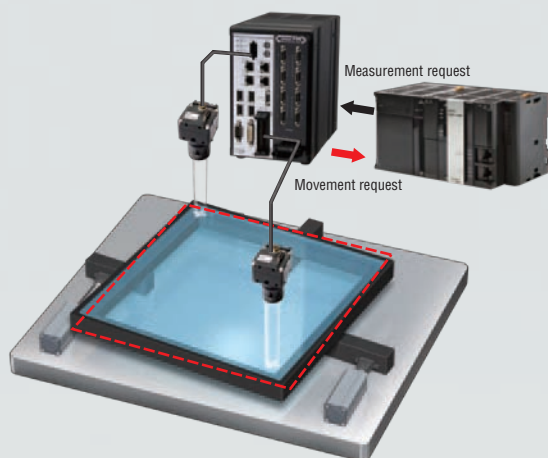

Precise Rotational Position Estimation

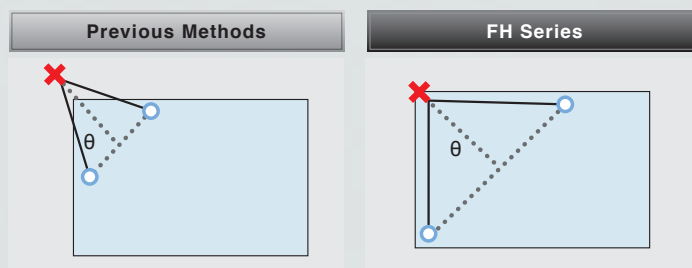

In order to estimate a rotational center position precisely, it is required to move to sampling points to ensure a large rotational angle in the q direction on the stage. With the previous methods, users had to calculate such sampling points and program the stage axis movements to move to the sampling points on the PLC. Finding the best sampling points was a trial and error process that required a significant amount of time.

The FH-series Vision System automatically calculates sampling points in the field of view to ensure the maximum rotational angle in the θ direction on the stage and sends the stage axis movement requests to the PLC to move to the sampling points. "Movement to sampling points by combining parallel movement and rotational movement", which was difficult to implement due to requiring complex calculations, can be now easily achieved by moving stage axes according to the instructions from the FH-series Vision System.

Automatically Calculated Calibration Data

Both affine transformation parameters and distortion correction parameters are calculated at the same time.

Affine Transformation

Positional relationship of Camera and stage

Stage axis movement per Camera pixel

Stage axis orthogonality

Distortion Correction

Trapezoidal compensation parameter

Lens distortion compensation parameter

Inspection and Measurement Process Library

Search

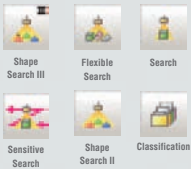

A complete array of search tools are provided to meet an array of requirements. Minute difference detection is supported without false detection.

Sensitive Search

This allows the recognition of very subtle differences that cannot be detected through ordinary search processes, by dividing the registered model image into several regions and carefully matching them. Delicate threshold setting is not required saving time in the registration process.

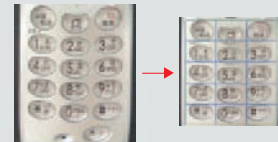

Different conditions for dividing the model image can be set.

Flexible Search

When inspecting workpieces with some variations in shape, these characteristics are sometimes recognized erroneously as defects. Flexible Search ensures accurate searches regardless of some variations in print quality or shape, by registering several images of non-defective products as models. It helps you decrease your inspection failure rate by rejecting defective products only.

Inspection of characters on IC chips

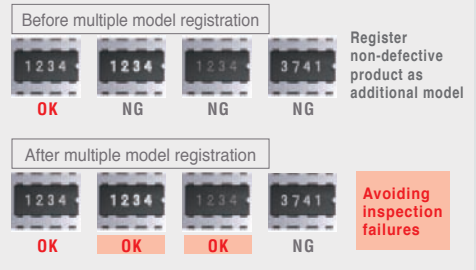

Edges

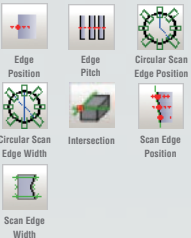

These processing items let you measure positions, widths, and the number of edges from edge extraction.

Circular Scan Edge Position

You can measure the center coordinates, diameter, and radius of a round workpiece without performing any calculations simply by drawing one measurement region.

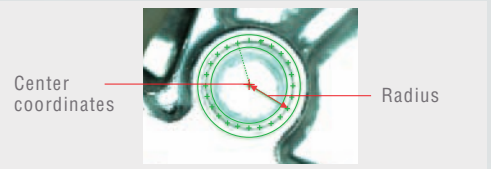

Circular Scan Edge Width

You can measure the center coordinates, width, and thickness of a ring-shaped workpiece without requiring additional calculation.



Defects

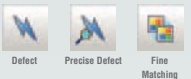

These processing items are ideal for external appearance inspections for damage, foreign matter, etc.

Inspections of Scratches and Dirt

Subtle scratches and dirt can be detected with more fine-tuned conditions compared to conventional inspections. Since you can clearly distinguish defects to be detected from the background, the failure detection rate can be decreased. Profiles of defects and comparison elements can be displayed on the screen in real time. You can adjust by confirming the settings and detection results on the image. Fine parameters for defect detection allow fine settings at the pixel level.



Scratch detection profile displayed on the screen Patent Pending

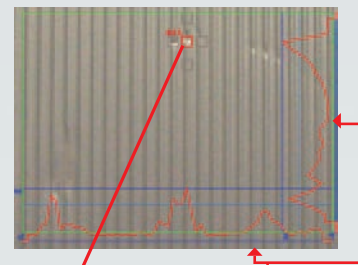

Comparison element display

Intervals and sizes of comparing elements are displayed.

Profile display

Defects of each direction for detection are displayed as wave profiles.

Fine Matching

It is useful for detecting scratches, chipped edges or subtle dirt in complex backgrounds.

Defect

It is useful for detecting scratches and dirt in plain backgrounds.

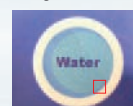

Fine Matching / Defect

With our Real Color Sensing technology, FH-series Vision System can accurately recognize and process subtle variations in color. This feature helps you detect unpredictable scratches and dirt. High precision defect inspections are possible by using both Fine Matching and Defect flexibly according to the background of each image.

Character Inspections/OCR



These processing items provide the functions that are required for inspections of characters such as dates and lot codes.

Stable Reading of Difficult-to-read Characters

Sometimes characters printed may be too close to each other, and character strings may be printed on curved surfaces. Even these instance, stable reading is now possible.

Touching characters



Curved character strings

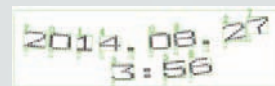

Correct Segmentation of Close or Touching Characters

When characters are too close to each other or touching, previous methods often failed to segment out each character; sometimes two characters at once or over-segmentation into character fragments. OMRON's newly developed optimized character segmentation method generates a number of extraction candidates from an entire character string to find out a correct answer from these candidates, ensuring overall consistency. This unique segmentation method brings robust character recognition for touching, distorted and/or inclined characters that have been previously difficult to read.

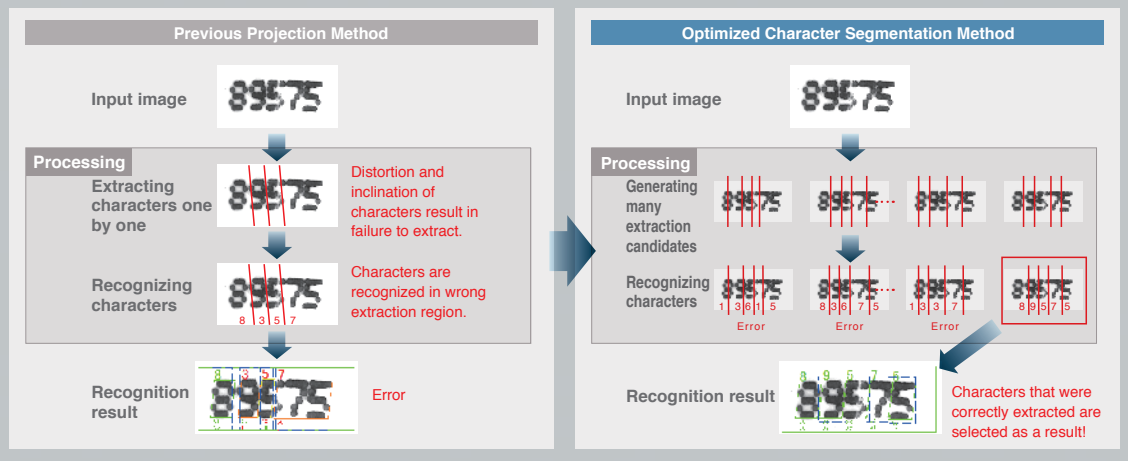

Easy Installation with Built-in Dictionary

Many previous character reading methods required dictionary setup before usage, which was tedious step. In contrary, based on OMRON's long and rich experiences in FA fields, possible variations of fonts and printing are already included and optimized to provide sophisticated performance as it is.

Characters from most printers can be read, including dot and impact printers. **Handles Approx. 80 Fonts**



Codes



FH enables bar /2D codes reading as well.

Printing quality evaluation based on ISO standards is supported. Applicable standards: ISO/IEC 15415 (The data matrix standard in ECC 200 is supported) and ISO/IEC 15416. FH can provide judgement of the code quality based on standardized printing quality criteria.

Glue Bead Inspection



You can inspect coating of a specified color for gaps or runoffs along the coating path.

Automatic Extraction of Complex Measurement Region Shapes

Measurement regions are no longer restricted to combinations of rectangles and circles. You can freely set the shape according to the outline of the workpiece. It's easy to set the measurement regions. Just specify one portion of the region to extract, and a continuous region with a similar color is extracted automatically. You can set precise regions for measurements even for scratch inspections or labeling on workpieces with complex shapes. This method to set measurement regions can be used for Gravity and Area, Color Data, Labeling, Defect, and Precise Defect processing items.

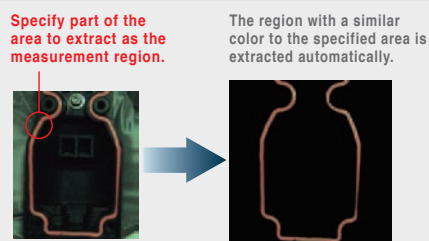
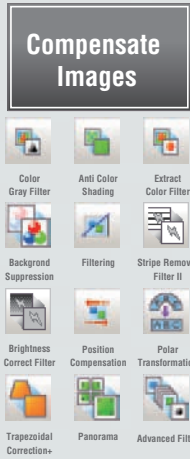
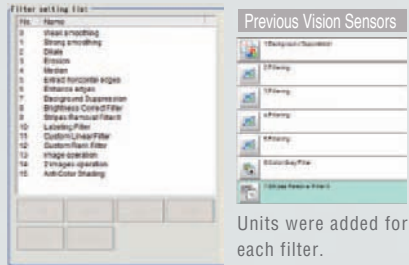

Image Filter Library



Advanced Filter

The image filter library has been condensed into one processing item. This allows you to easily set complex filtering as required for external inspections.



You set up to 16 of the 24 different filters.

Advanced Filter

Many different filter functions can be set with just one processing unit.

The average image is obtained from multiple images.

Application Flow Example

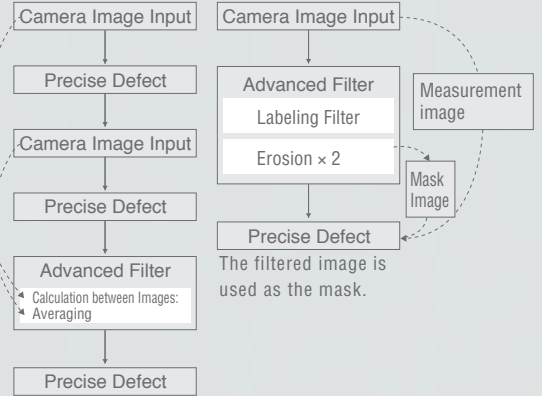

The filtered image is used as the mask.

Labeling Filter

This filter uses label processing to output an extracted image that contains only the specified characteristic labels.

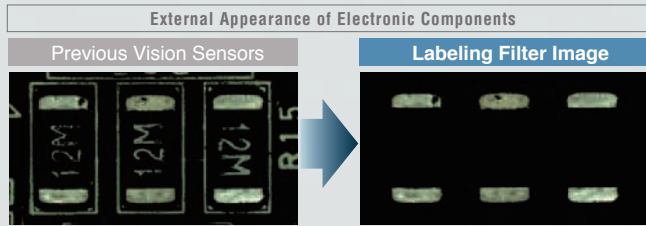

Extraction is possible only with color or brightness information.

Extraction of labels with specified areas or shapes is possible.

Calculations between Images

You can perform arithmetic operations, bit operations, averaging, or maximum/minimum operations between two images.

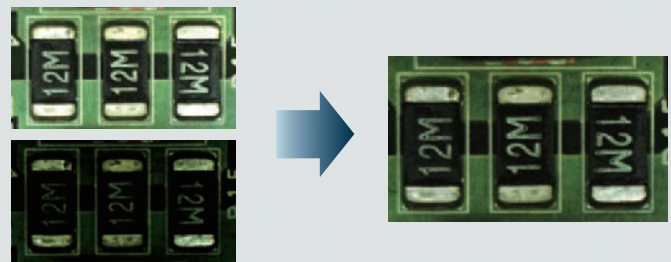

Example: You can get the average of two images that were taken under different imaging conditions.

Custom Filter

You can set the mask coefficients as required for these filters. The mask size can be up to 21 x 21. You can more flexibly set image smoothing, edge extractions, dilation, and erosion.

Example: Dilation/Erosion in One Direction



Filter Coefficients



You can set the filter coefficients as required.

Brightness Correct Filter

These filter cut out uneven lighting and changes in brightness caused by work-piece surface irregularities to make characteristic features stand out clearly.

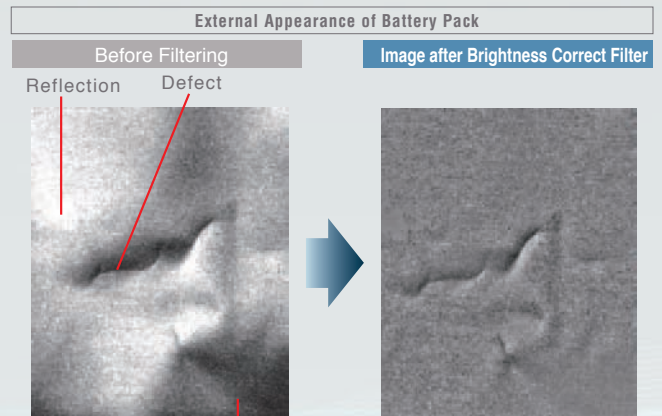



Shadow

The wavy inconsistencies are judged as defects.

Uneven areas are removed so that only the defect appears in the inspection.

Stripe Removal Filter II

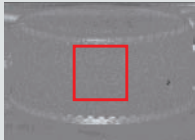
The stripped pattern is filtered out so that only required aspects are shown clearly. Vertical, horizontal, and diagonal stripes can be removed.

External Appearance of Bottle Cap	
Unfiltered Image	Image after Stripe Removal Filter
	
<p>Inspection is possible only in the small portion without stripes.</p>  <p>Due to the stripes, inspection is possible only in the very center of the image. To inspect the entire surface, the cap must be rotated and many images must be taken.</p>	<p>Even the defect at the edge of the image can be detected after stripe removal.</p>  <p>Because inspection is possible to the sides of the image, the number of images that is required to inspect the entire cap is greatly reduced.</p>

High Dynamic Range to Easily Combine Images

To simply combine images, you must set the imaging conditions and create the images that you want to obtain. With OMRON's high dynamic range function, all you need to do is to set the upper and lower brightness images on a graph of the image brightness distribution to make the adjustments.







Dynamic range after HDR processing

Industry's highest dynamic range

Max. 5000 times higher than previous models

What is Real Color Sensing?

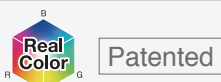

In order to secure stable measurements in different inspection environments, FH Series feature Omron's proprietary Real Color Sensing processing, in addition to the conventional color image processing.



Edges are detected reliably even when the contrast between the background and subject is low.

Color Segmentation Processing



Color images taken by the camera are processed after being converted into black and white pixels. The color extracted is represented as white, and the other colors as black. Based on minimum information, high speed processing is possible. Since color data is limited only to brightness, however, it takes a long time to make optical adjustments for extracting color features.

Color Image Processing



Color images are converted into 256 levels of black-and-white brightness and the contrasts of specific colors is enhanced. More precise, stable results can be produced compared to color segmentation. However, this method has difficulty in capturing subtle variations in color because all colors are converted into black-and-white brightness levels. Therefore, it is difficult to detect subtle changes in images with low contrast.

Real Color Sensing

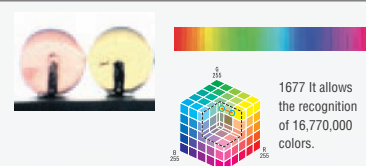

Different colors are represented as different positions in the 3D RGB space. Subtle variations in color can be recognized by representing them as distances between different color pixels comprising this space. Thus, scratches and dirt can be detected accurately even in images with low contrast.



Utility Library

Unit Macro/ Unit Calculation Macro

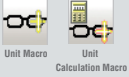

Unit Macro

Unit Macro let you easily achieve flow control that normally requires complex programming from the user interface. Improvements to the setup from the user interface provides ease of selection and modification of the programming process.

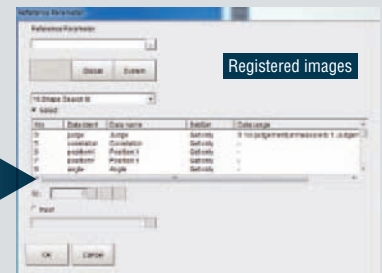
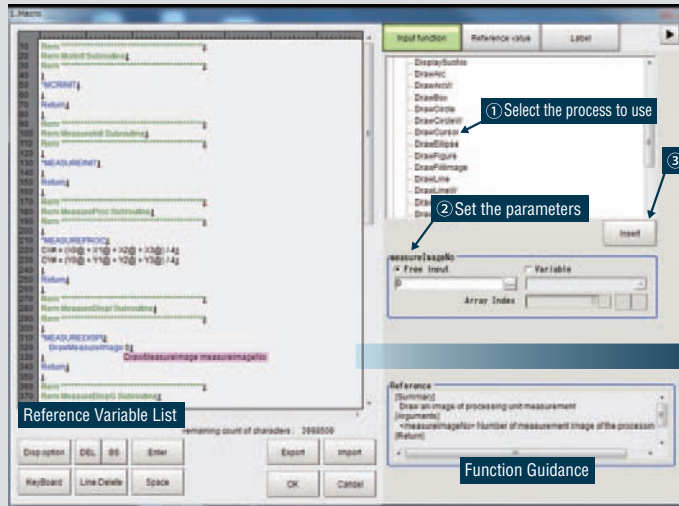

Variables can be used in Unit Macro to access processing item data and system data.

For example, it would previously have been long and complicated to change the set parameters of a processing item for each product model. With a Unit Calculation Macro processing item, the flow is shorter and setting changes are easy to achieve.

Previous Vision Sensors

FH/FZ5-series Unit Macro

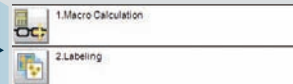
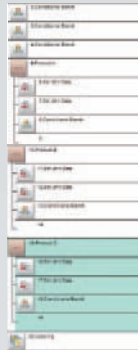

Just enter the values of the variables to update the parameters.

```
' Branching for each product model
Select INDEX@
Case 0
  ExtCond0@ = 1 ' Area
  ExtParam0@ = 0
  ExtParam1@ = 10000
Case 1
  ExtCond0@ = 4 ' Elliptic major axis
  ExtParam0@ = 0
  ExtParam1@ = 100
Case 2
  ExtCond0@ = 7 ' Rectangle width
  ExtParam0@ = 0
  ExtParam1@ = 200
End Select
```

Unit Calculation Macro

You can create expressions that require multiple lines in one processing item. In addition to making calculations, you can also make judgements based on the calculation results of the processing items.

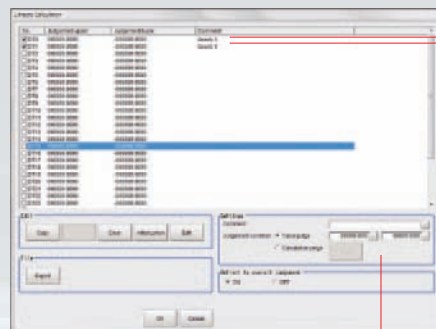

Example 1: Multiline Expression

```
DET# = A0@ * B1@ - A1@ * B0@ ' Calculates intersection
CX# = (B0@ * C1@ - B1@ * C0@) / DET# ' X coordinate of intersection
CY# = (A1@ * C0@ - A0@ * C1@) / DET# ' Y coordinate of intersection
```

Example 2: Calculations to Drive Branching or Loops

```
Max# = 0
For i& = 0 To 10
  If (Max # < value#(i&)) Then
    Max# = value#(i&)
  EndIf
Next
RESULTDATA#(0) = Max#
```

Judgement condition for calculation results

User Data



Ideal for Managing Inspection Standards and for Statistical Analysis of Inspection Results

Shared data used within scene groups as constants and variables in the measurement flow can be set as user data. With the shared data, you can use the measurement flow in many new ways, including standard values, conditional branching flags, and counters.

Application Example 1 | Unified Management of Judgment Values

When setting up complex scene data, such as the data required for inspection of many different models, you can unify management of important judgment values for inspections to easily manage and then adjust them later. Also, if you isolate in advance the settings that are critical to inspection performance (and normally known only to the designer) as user data, the locations that require adjustment can be clarified so that the user can more easily make adjustments.

Application Example 2 | Statistical Information on Productivity Indices

User data can be used as variables that can be read and written in the inspection flow. It can also be used for counters for the number of inspected workpieces or the number of NG workpieces. Math functions can be used to calculate failure rates and display them onscreen so that productivity can be checked at any time.

Adjustment of All User Data in a List

No.	Data	Comment
0	00.0000	Man 1-A Search Judgement
1	00.0000	Man 1-B Search Judgement
2	00.0000	Man 2-A Search Judgement
3	00.0000	Man 2-B Search Judgement
4	0.0000	NG-Counter
5	0.0000	
6	0.0000	
7	0.0000	
8	0.0000	
9	0.0000	

Indices Displayed Onscreen with the Result Display Function



Application Method

All you have to do is set a User Data processing item in the inspection flow.

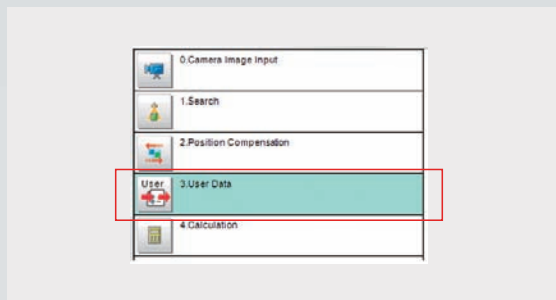

The data that is set as user data is used as shared constants and variables in different scenes.

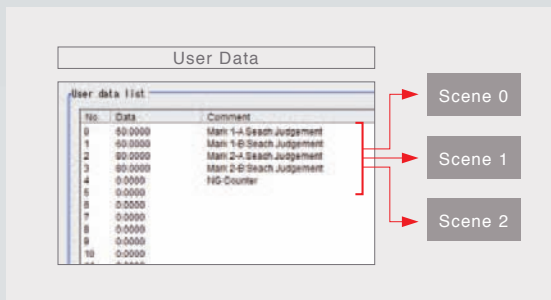

Trend Monitor



Results Analysis with Trend Monitors

You can graph trends in measurement values to output warnings before failures occur. This helps provide feedback to earlier processes to prevent NGs in advance and to analyze the causes of NGs.

Prevent High Defect Rates in Advance

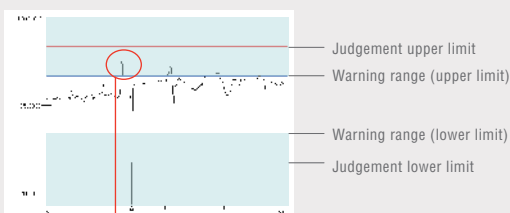

You can set the warning range to output warnings before failures occur to provide feedback to earlier processes.

Cause Analysis when Defects Occur

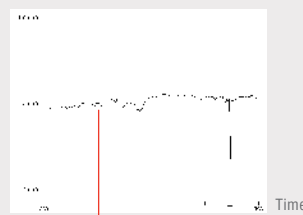

The 100,000 most recent measurement values are stored.

Operation and Analysis

Optimum Operation both Online and Offline

Connections to a network hard disk drive or network computer enables a wide range of operation possibilities.

You can log measurement images longterm, or you can perform verifications and adjustments on a computer without stopping the FH-series Vision System.

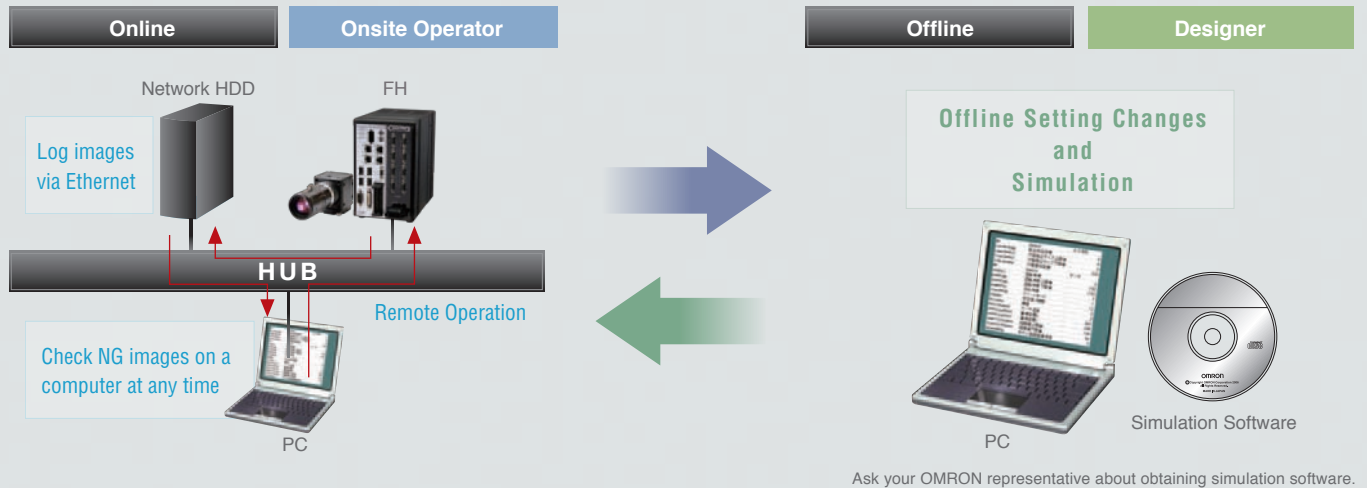

New Operation Schemes through Network Applications

1 Daily Monitoring

You can store NG image in a network HDD to check the NG images every day on a computer without reducing measurement performance. Or you can start simulation software on your computer to remeasure and analyze NG images.

2 Periodic Adjustments and Inspection Adjustments

The non-stop adjustment function lets you change Controller settings without stopping the production line. With remote operation, you can perform operations without going onsite.

3 Handling Unstable Inspections or Measurement Failure

The user sends the programmer the image data, setting data, and parameter settings. The programmer can use the simulation software on the computer to check the process and change the settings with the simulation software. The altered scene data can be returned to the user and loaded to the system to complete the adjustments. This enables modifications without requiring the programmer to be on site.

4 Adding Inspections or Making Changes for New Models

Based on the images to be inspected, settings are made on the simulation software on a PC running simulation software. The scene data is sent to the user to easily add the new settings.

Ideal for History Management

CSV files allow you to easily understand the parameter settings. Also, you can easily change any of the settings.

1 Comparisons

If you save the basic settings, you can easily extract any differences in settings caused by changes made incorrectly.

Standard settings		Current parameter settings	
0001	0001	0001	0001
0002	0002	0002	0002
0003	0003	0003	0003
0004	0004	0004	0004
0005	0005	0005	0005
0006	0006	0006	0006
0007	0007	0007	0007
0008	0008	0008	0008
0009	0009	0009	0009
0010	0010	0010	0010
0011	0011	0011	0011
0012	0012	0012	0012
0013	0013	0013	0013
0014	0014	0014	0014
0015	0015	0015	0015
0016	0016	0016	0016
0017	0017	0017	0017
0018	0018	0018	0018
0019	0019	0019	0019
0020	0020	0020	0020
0021	0021	0021	0021
0022	0022	0022	0022
0023	0023	0023	0023
0024	0024	0024	0024
0025	0025	0025	0025
0026	0026	0026	0026
0027	0027	0027	0027
0028	0028	0028	0028
0029	0029	0029	0029
0030	0030	0030	0030
0031	0031	0031	0031
0032	0032	0032	0032
0033	0033	0033	0033
0034	0034	0034	0034
0035	0035	0035	0035
0036	0036	0036	0036
0037	0037	0037	0037
0038	0038	0038	0038
0039	0039	0039	0039
0040	0040	0040	0040
0041	0041	0041	0041
0042	0042	0042	0042
0043	0043	0043	0043
0044	0044	0044	0044
0045	0045	0045	0045
0046	0046	0046	0046
0047	0047	0047	0047
0048	0048	0048	0048
0049	0049	0049	0049
0050	0050	0050	0050

2 Remote Adjustment

You can attach CSV files to email and upload settings to the FH-series Vision System to easily make adjustments from remote locations when problems occur.



Remote Operation Centralizes Monitoring and Adjustment of multiple controllers

You can check the status and adjust the settings of multiple units on one computer.

This enables efficient adjustment of Camera images when commissioning a system and application of test adjustment results.

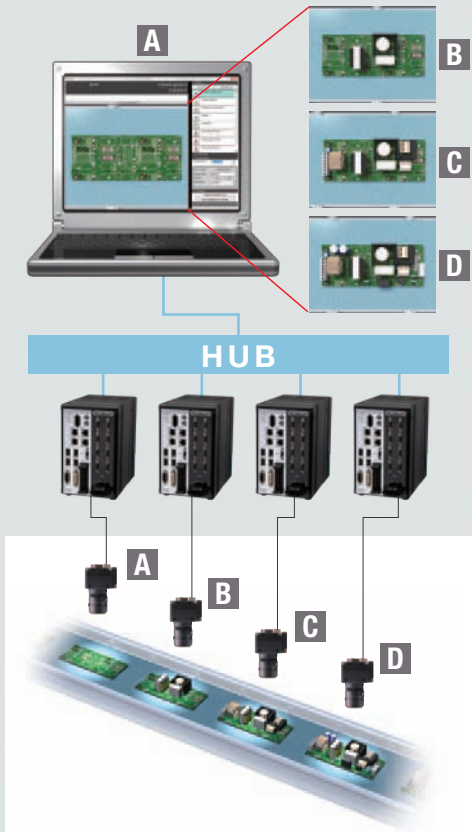

Application Example 1 | Operating Several FH from One Location

- 1 When commissioning an installation from one location you can adjust the camera for all the controllers located along the line. There's no need to go to and from each Controller, and you can compare Camera images under various conditions to adjust them.
- 2 If setting changes are necessary to add a new model, you can do all the required work at the same time without making trips to all of the Controllers.
- 3 You can easily balance the thresholds between Controllers when increasing inspection stability through testing at the production line.

Application Example 2 | Display images from multiple controllers

- 1 Space savings with a single monitor installation.
- 2 Single location programming for multiple controllers facilitates adjustments and reduces programmer movement.

Note: Ask your OMRON representative about obtaining simulation software for a computer.

Saving and Using Measurement Images

Save Images Directly in JPEG or BMP Format

You can easily view images on a computer or attach them to reports. With BMP files, you can measure them again on the Vision controller.

Restricting the Areas of Saved Images

By restricting the areas that are saved, file sizes are smaller so you can continue to log even more files.



Save Both Filtered and Unfiltered Images

You can save both the filtered images that were actually measured and the raw images taken directly from the Camera. You can therefore tell if an NG was caused by the input image or by the filter settings.

Filtered Images

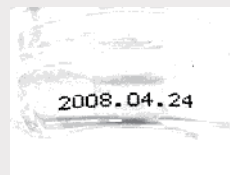

Unfiltered Images



Utilities That Don't Stop Your Machines

Making Confirmations and Adjustments without Stopping Production **Non-stop adjustment**

Parallel processing on Four-core CPU not only speeds up measurements, but it enables parallel processing of measurements and adjustments. Automatic distributed processing means that measurements are not delayed when adjustments are applied.

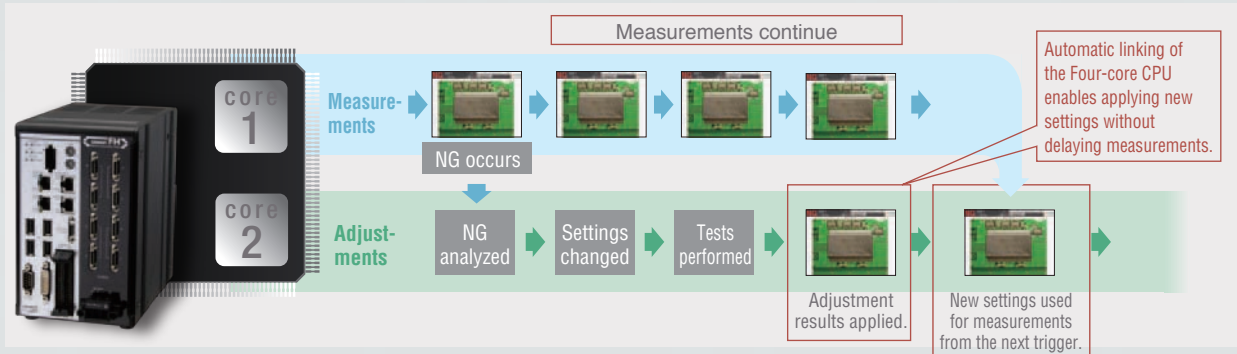

Doubly effective when combined with the Non-stop adjustment mode NG analyzer

You can display in a structured manner a graph showing the results measured at once on logging images. This lets you identify the cause of a given NG much more quickly. You can also measure all images again after changing a given setting, to check the reliability of the new setting. Adjustment and troubleshooting has never been so quick, simple and reliable.

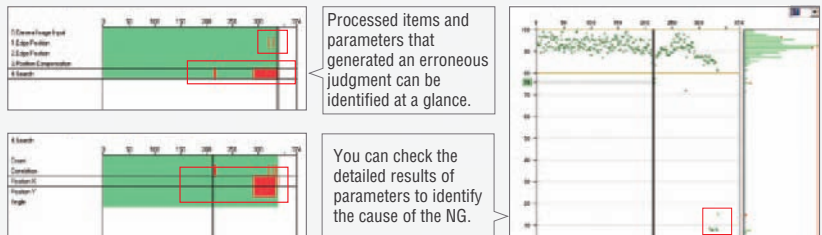

Save All Images Even during Measurements **High speed logging**

The Four-core CPU can also perform parallel processing of measurements and image logging, with high-speed connection to a high-capacity hard disk (3terabytes). Trend analysis of saved images, quickly isolates NG's and facilitates countermeasures.

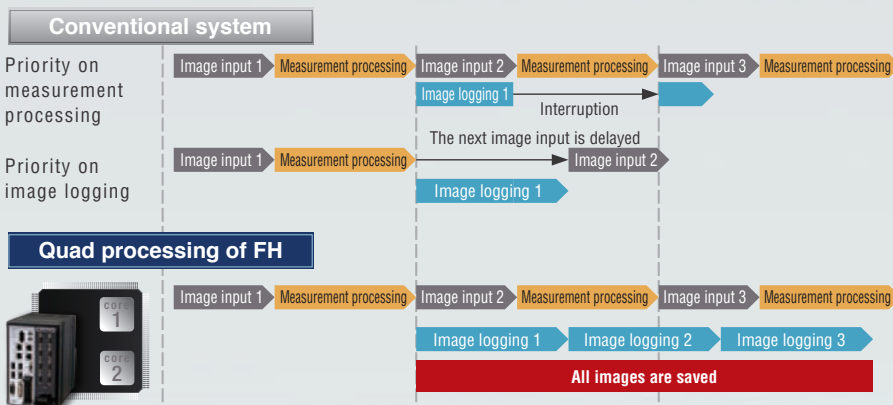

*1 All images can be saved under the following conditions:
 • 300,000-pixel camera x 1 unit . Measurement time: 20 ms
 • Images can be saved continuously for approx. five days when a 3-terabyte HDD is used (based on 8 hours of operation a day).

Issues

Since logging was not possible during measurement, the user had to choose either measurement or logging. Accordingly, not all images could be saved or image input triggers had to be delayed depending on the measurement trigger intervals.

Resolution

Measurement and image logging are processed completely in parallel. As a result, you can save all images.

Seamless Communications with Peripheral Devices

Complete Interfaces for All Connected Devices

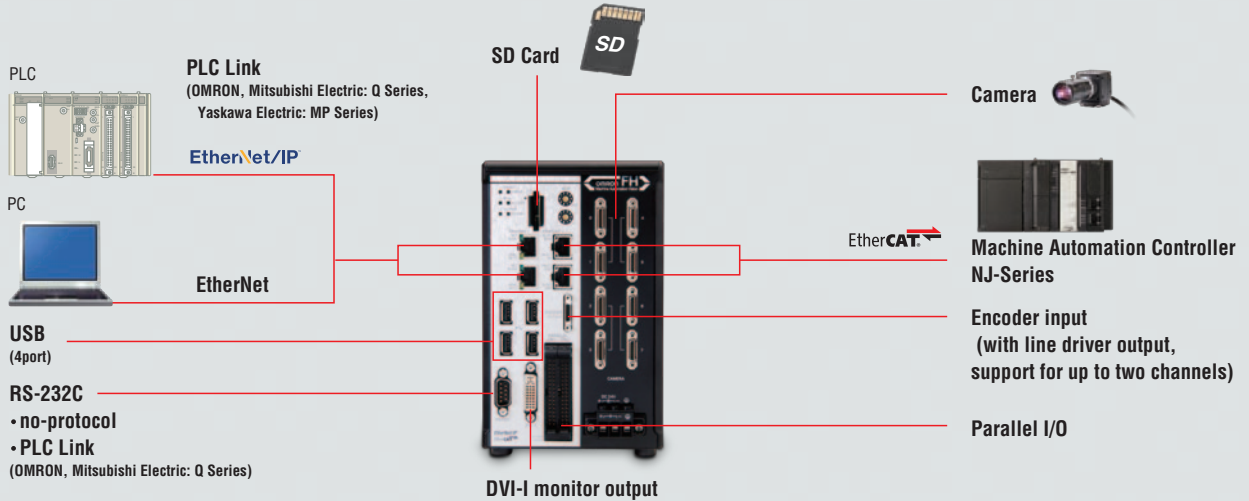

Controlling Flow Branching Conditions from an External Device

You can control branching by using commands and signal inputs from external devices as branching conditions for the measurement flow.

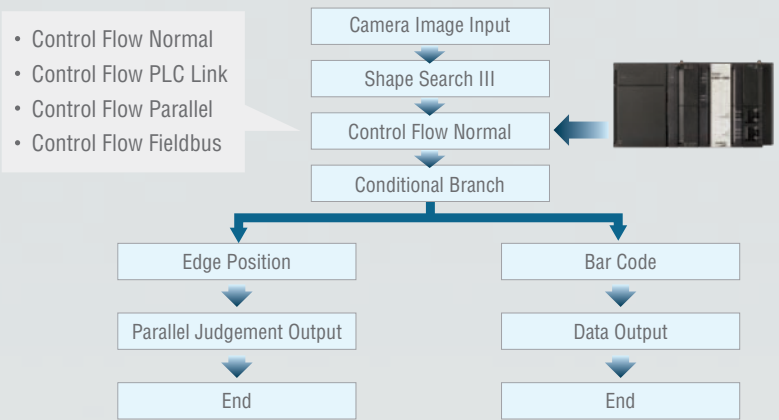

Communication Command Macro

You can shorten the communications time by using commands for complex controls or by shortening multiple commands. You can also define how the Vision System responds to the communications commands. For example, you can define one command to change both a scene and perform measurements.

No.	BUS/IO	Command name	Function name
<input checked="" type="checkbox"/>	0	CMD0000	FUNC_0000
<input type="checkbox"/>	1	CMD0001	FUNC_0001
<input type="checkbox"/>	2	CMD0002	FUNC_0002
<input type="checkbox"/>	3	CMD0003	FUNC_0003
<input type="checkbox"/>	4	CMD0004	FUNC_0004
<input type="checkbox"/>	5	CMD0005	FUNC_0005
<input type="checkbox"/>	6	CMD0006	FUNC_0006
<input type="checkbox"/>	7	CMD0007	FUNC_0007
<input type="checkbox"/>	8	CMD0008	FUNC_0008
<input type="checkbox"/>	9	CMD0009	FUNC_0009

You can define up to 256 commands

The screenshot shows the 'Combining command processing' interface with the following steps:

- Select the command:** A list of commands is shown, with 'ChangeSceneID' selected.
- Set the parameters:** The 'sceneNo' parameter is set to 'Free input'.
- Insert the command:** The 'Insert' button is clicked to add the command to the macro.

Additional interface elements include 'Command Guidance', 'Remaining count of characters: 199236', and keyboard shortcuts (F5, F6, F7).

Options for More Power Customization

Application Producer provides a Development Environment to Build and Simulate Applications

You can further customize the standard controller features of the FH-series Vision System. In Application Producer custom control units allow development of original interfaces with Microsoft® Visual Studio®. The software command reference helps create original processing items, and more.

Application Producer Main Window

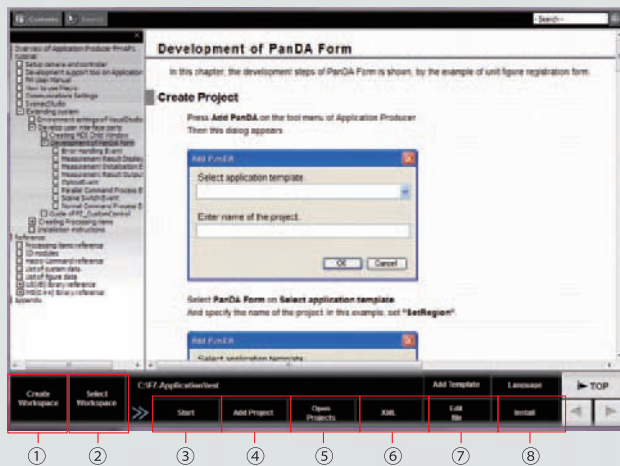

- ① Create workspaces.
- ② Select and change between workspaces.
- ③ Start the program in the selected workspace.
- ④ Add projects.
- ⑤ Open Microsoft® Visual Studio® projects.
- ⑥ Start the XML generation tool.
- ⑦ Open setup files.
- ⑧ Create installation files.

Customization Example: GUI Customization

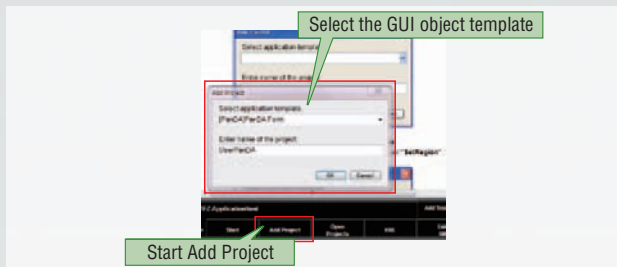

Start Add Project and select the template that will serve as a base for customization. Selecting an interface template as a base first greatly reduces the work that is required compared with programming interfaces from scratch.

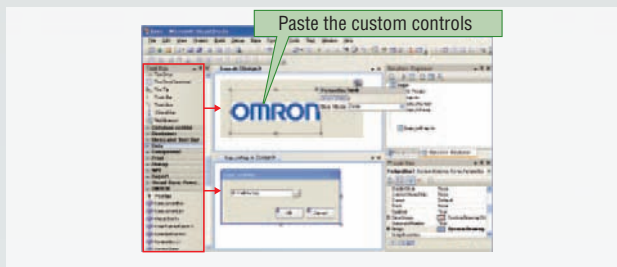

The Application Producer will automatically generate a project file from the selected template so that you can open it in Microsoft® Visual Studio®. You can develop interfaces just by dragging FH-series custom controls and Windows-based controls.

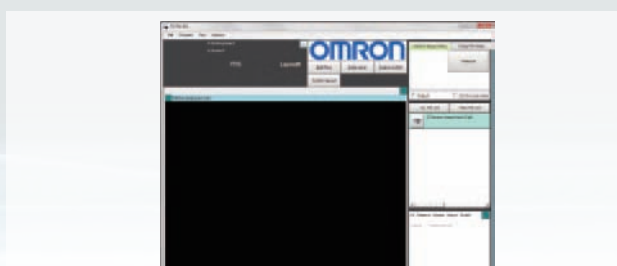

Instead of writing the program code from scratch to build an interface, you can easily build the interface simply by pasting custom controls. You can immediately check and debug the operation of the GUI objects that you add.

Easily Control Lights from Vision System

Camera-mount Lighting Controller FLV-TCC Series



Simple wiring and space saving

Wiring from the control panel to remote Cameras and Lights is simplified.

The more Cameras and Lights are connected to the Vision System Controller, the more effective in simplifying wiring and saving space.

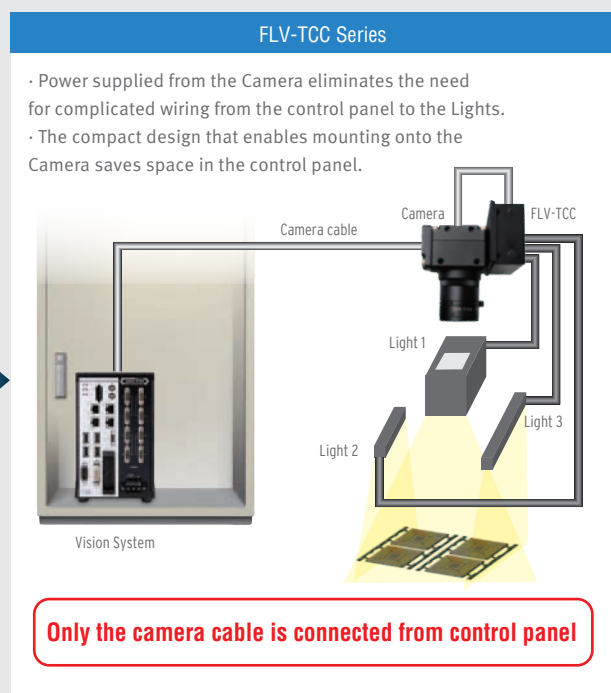
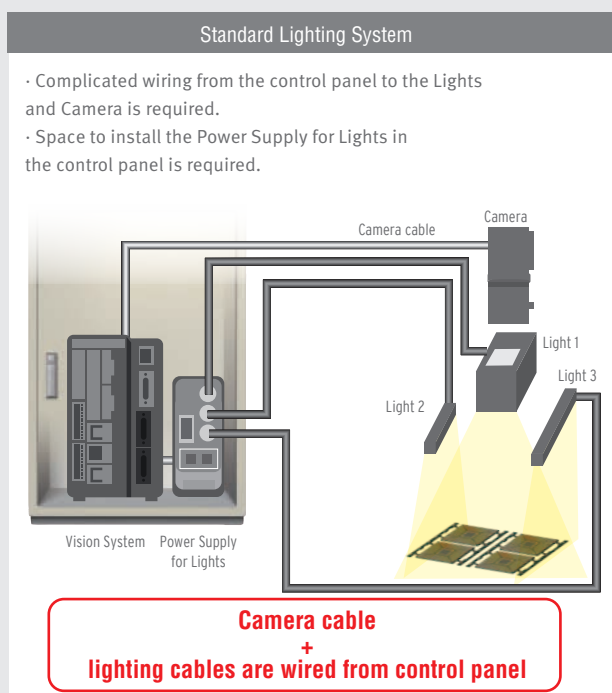

OMRON's Light Lineup

Standard Model FLV Series

■ Direct Ring Light



■ Bar Light



■ Coaxial Light



■ Edge Type Light



■ Edge Type Light



■ Direct Back Light



■ Dome Light



■ Shadowless Light



High-brightness Model FL Series

■ Bar Light



■ Direct Ring Light



OMRON also provides many other models of Lights.
Please ask your OMRON representative for details.

Vision System FH-Series

Easier to Embed in Machine, Shorter Machine Cycle Times

- Calculations are easy to set for the results from four parallel tasks.
- Synchronous control of devices connected via EtherCAT is possible.
- The new Shape Search III processing item enables fast, precise, and stable measurements.
- Microsoft® .NET is supported to share machine interface with PC.
- User interface customization is supported.



System configuration

EtherCAT connections for FH series

Example of the FH Sensor Controllers (4-camera type)

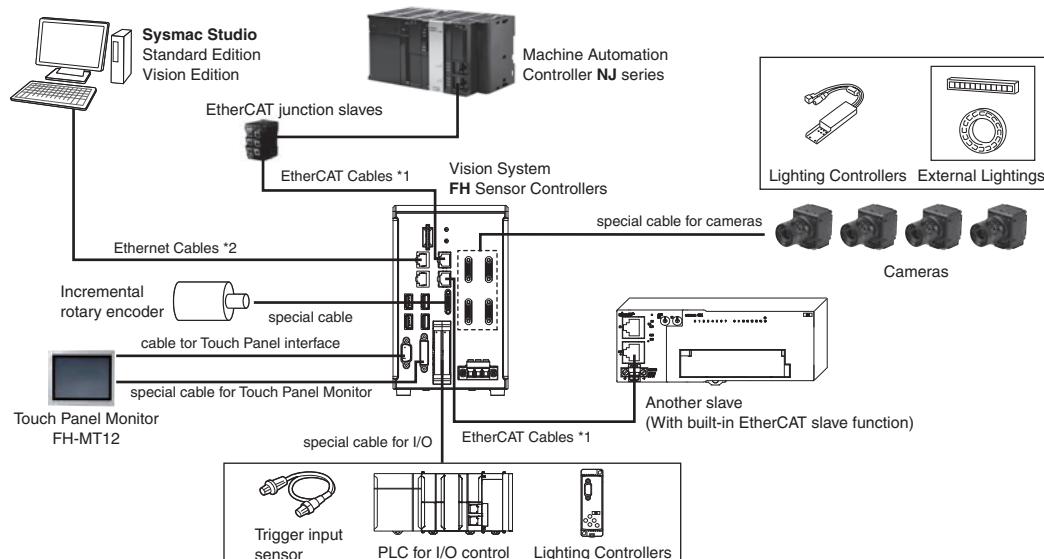

*1. To use STP (shielded twisted-pair) cable of category 5 or higher with double shielding (braiding and aluminum foil tape) for EtherCAT and RJ45 connector.
*2. To use STP (shielded twisted-pair) cable of category 5 or higher for Ethernet and RJ45 connector.

Ordering Information

FH Series Sensor Controllers

Item	CPU	No. of cameras	Output	Model	
	Box-type controllers	High-speed Controllers (4 core)	2	NPN/PNP	FH-3050
			4	NPN/PNP	FH-3050-10
			8	NPN/PNP	FH-3050-20
		Standard Controllers (2 core)	2	NPN/PNP	FH-1050
			4	NPN/PNP	FH-1050-10
			8	NPN/PNP	FH-1050-20

FZ5 Lite Series Sensor Controllers

Item	CPU	No. of cameras	Output	Model	
	Box-type controllers	Lite Controllers	2	NPN	FZ5-L350
			2	PNP	FZ5-L355
		4	NPN	FZ5-L350-10	
			PNP	FZ5-L355-10	

Note: Refer to the FZ5 Series Data sheet (Cat. No. Q203) for details.

Cameras

Item	Descriptions	Color / Monochrome	Image Acquisition Time	Model
	12 million pixels (Up to four cameras can be connected to one Controller. Up to eight cameras other than 12 million-pixel cameras can be connected to a FH-3050-20 or a FH-1050-20.)	Color	25.7 ms *	FH-SC12
		Monochrome		FH-SM12
	4 million pixels	Color	8.5 ms *	FH-SC04
		Monochrome		FH-SM04
	2 million pixels	Color	4.6 ms *	FH-SC02
		Monochrome		FH-SM02
	300,000 pixels	Color	3.3 ms	FH-SC
		Monochrome		FH-SM
	5 million pixels (When connecting FZ5-L35□, up to two cameras can be connected.)	Color	62.5 ms	FZ-SC5M2
		Monochrome		FZ-S5M2
	2 million pixels	Color	33.3 ms	FZ-SC2M
		Monochrome		FZ-S2M
	300,000 pixels	Color	12.5 ms	FZ-SC
		Monochrome		FZ-S
	300,000 pixels	Color	4.9 ms	FZ-SHC
		Monochrome		FZ-SH
	300,000-pixel flat type	Color	12.5 ms	FZ-SFC
		Monochrome		FZ-SF
	300,000-pixel pen type	Color	12.5 ms	FZ-SPC
		Monochrome		FZ-SP
	Narrow view	Color	16.7 ms	FZ-SQ1010F
	Standard view	Color		FZ-SQ050F
	Wide View (long-distance)	Color		FZ-SQ100F
	Wide View (short-distance)	Color		FZ-SQ100N

* Frame rate in high speed mode when the camera is connected using two camera cables. For other conditions, please refer to the chart below.

Model		FH-SM02	FH-SC02	FH-SM04	FH-SC04	FH-SM12	FH-SC12
Image Acquisition Time	2 Cables *1	High Speed Mode *2	4.6ms	8.5ms	25.7ms		
		Standard Mode	9.7ms	17.9ms	51.3ms		
	1 Cables	High Speed Mode *2	9.2ms	17.0ms	51.3ms		
		Standard Mode	19.3ms	35.8ms	102.0ms		

* 1. Two Camera ports of the controller are used per one camera.

* 2. Up to 5 m Camera Cable length.

Camera Cables

Item	Descriptions	Model
	Camera Cable Cable length: 2 m, 3 m, 5m, or 10 m *2	FZ-VS3
	Bend resistant Camera Cable Cable length: 2 m, 3 m, 5m, or 10 m *2	FZ-VSB3
	Right-angle Camera Cable *1 Cable length: 2 m, 3 m, 5m, or 10 m *2	FZ-VSL3
	Bend resistant Right-angle Camera Cable *1 Cable length: 2 m, 3 m, 5 m, or 10 m *2	FZ-VSLB3
	Long-distance Camera Cable Cable length: 15 m *2	FZ-VS4
	Long-distance Right-angle Camera Cable *1 Cable length: 15 m *2	FZ-VSL4
	Cable Extension Unit Up to two Extension Units and three Cables can be connected. (Maximum cable length: 45 m *2)	FZ-VSJ

*1 This Cable has an L-shaped connector on the Camera end.

*2 The maximum cable length depends on the Camera being connected, and the model and length of the Cable being used. For further information, please refer to the "Cameras / Cables Connection Table" and "Maximum Extension Length Using Cable Extension Units FZ-VSJ table".
When a high-speed CMOS camera FH-S□02/-S□04/-S□12 is used in the high speed mode of transmission speed, two camera cables are required.

Cameras / Cables Connection Table

Type of camera	Model	Cable length	High-speed CMOS cameras *							
			300,000-pixel	2 million-pixel		4 million-pixel		12 million-pixel		
			FH-SM/SC	FH-SM02/SC02		FH-SM04/SC04		FH-SM12/SC12		
			—	High speed mode of transmission speed select	Standard mode of transmission speed select	High speed mode of transmission speed select	Standard mode of transmission speed select	High speed mode of transmission speed select	Standard mode of transmission speed select	
Camera Cables Right-angle camera cables	FZ-VS3 FZ-VSL3	2 m	Yes	Yes	Yes	Yes	Yes	Yes	Yes	
		3 m	Yes	Yes	Yes	Yes	Yes	Yes	Yes	
		5 m	Yes	Yes	Yes	Yes	Yes	Yes	Yes	
		10 m	Yes	No	Yes	No	Yes	No	Yes	
Bend resistant camera cables Bend resistant	FZ-VSB3 FZ-VSLB3	2 m	Yes	Yes	Yes	Yes	Yes	Yes	Yes	
		3 m	Yes	Yes	Yes	Yes	Yes	Yes	Yes	
		5 m	Yes	Yes	Yes	Yes	Yes	Yes	Yes	
		10 m	Yes	No	Yes	No	Yes	No	Yes	
Long-distance camera cable Long-distance right-angle	FZ-VS4 FZ-VSL4	15 m	Yes	No	Yes	No	Yes	No	Yes	

Type of camera	Model	Cable length	Digital CCD cameras			Small digital CCD cameras Pen type / flat type	High-speed CCD cameras	Intelligent compact CMOS cameras
			300,000-pixel	2 million-pixel	5 million-pixel			
			FZ-S/SC	FZ-S2M/SC2M	FZ-S5M2/SC5M2	FZ-SF/SFC FZ-SP/SPC	FZ-SH/SHC	FZ-SQ□
Camera Cables Right-angle camera cables	FZ-VS3 FZ-VSL3	2 m	Yes	Yes	Yes	Yes	Yes	Yes
		3 m	Yes	Yes	Yes	Yes	Yes	Yes
		5 m	Yes	Yes	Yes	Yes	Yes	Yes
		10 m	Yes	Yes	No	Yes	Yes	Yes
Bend resistant camera cables Bend resistant Right-angle	FZ-VSB3 FZ-VSLB3	2 m	Yes	Yes	Yes	Yes	Yes	Yes
		3 m	Yes	Yes	Yes	Yes	Yes	Yes
		5 m	Yes	Yes	Yes	Yes	Yes	Yes
		10 m	Yes	Yes	No	Yes	Yes	Yes
Long-distance camera cable Long-distance right-angle camera cable	FZ-VS4 FZ-VSL4	15 m	Yes	Yes	No	Yes	Yes	Yes

Maximum Extension Length Using Cable Extension Units FZ-VSJ

Item	Model	Transmission speed (*1)	No. of CH used for connection (*2)	Maximum cable length using 1 Camera Cable (*1)	Max. number of connectable Extension Units	Using Cable Extension Units FZ-VSJ						
						Max. cable length	Connection configuration					
High-speed CMOS Cameras	FH-SM/SC	---	---	15 m (Using FZ-VS4/VSL4)	2	45 m	[Configuration 1] Camera cable: 15 m × 3 Extension Unit: 2					
							[Configuration 1] Camera cable: 15 m × 3 Extension Unit: 2					
	FH-SM02/SC02 FH-SM04/SC04 FH-SM12/SC12	Standard	1	15 m (Using FZ-VS4/VSL4)	2	45 m	[Configuration 1] Camera cable: 15 m × 3 Extension Unit: 2					
							[Configuration 2] Camera cable: 15 m × 6 Extension Unit: 4					
							High speed	1	5 m (Using FZ-VS□/VSL□)	2	15 m	[Configuration 3] Camera cable: 5 m × 3 Extension Unit: 2
												[Configuration 4] Camera cable: 5 m × 6 Extension Unit: 4
FZ-S/SC FZ-S2M/SC2M	---	---	15 m (Using FZ-VS4/VSL4)	2	45 m	[Configuration 1] Camera cable: 15 m × 3 Extension Unit: 2						
						[Configuration 3] Camera cable: 5 m × 3 Extension Unit: 2						
Digital CCD Cameras	FZ-S5M2/SC5M2	---	---	5 m (Using FZ-VS□/VSL□)	2	15 m	[Configuration 3] Camera cable: 5 m × 3 Extension Unit: 2					
Small Digital CCD Cameras	FZ-SF/SFC FZ-SP/SPC	---	---	15 m (Using FZ-VS4/VSL4)	2	45 m	[Configuration 1] Camera cable: 15 m × 3 Extension Unit: 2					
High-speed CCD Cameras	FZ-SH/SHC	---	---	15 m (Using FZ-VS4/VSL4)	2	45 m	[Configuration 1] Camera cable: 15 m × 3 Extension Unit: 2					
Intelligent Compact	FZ-SQ□	---	---	15 m (Using FZ-VS4/VSL4)	2	45 m	[Configuration 1] Camera cable: 15 m × 3 Extension Unit: 2					

*1 The FH-S□□□ enables switching between standard and high speed modes. In high speed mode, images can be transferred approximately two times faster than in standard mode, but the connectable cable length will be shorter.
 *2 The FH-S□□□ has two channels to connect Camera Cables. Connection to two channels makes image transfer two times faster than connection to one channel: high speed mode using two channels can transfer approximately four times as many images as standard mode using one channel.
 *3 Each channel can be used to connect up to two Cable Extension Units: up to four extension units, two channels x two units, can be connected by using two channels.

Connection Configuration

	Connection configuration using the maximum length of Camera Cables	Remarks
Configuration 1		
Configuration 2		
Configuration 3		
Configuration 4		

*4 Select the Camera Cables between the Controller and Extension Unit, between the Extension Units, and between the Extension Unit and Camera according to the connected Camera.
 Different types or lengths of Camera Cables can be used for (1), (2), and (3) as well as for (4), (5), and (6). However, the type and length of Camera Cable (1) must be the same as those of Camera Cable (4), (2) must be the same as (5), and (3) must be the same as (6).

Touch Panel Monitor

Item	Descriptions	Model
	Touch Panel Monitor 12.1 inches For FH Sensor Controllers *	FH-MT12

* FH Series Sensor Controllers version 5.32 or higher is required.

Touch Panel Monitor Cables

Item	Descriptions	Model
	DVI-Analog Conversion Cable for Touch Panel Monitor Cable length: 2 m, 5 m or 10 m	FH-VMDA
	RS-232C Cable for Touch Panel Monitor Cable length: 2 m, 5 m or 10 m	XW2Z-□□□PP-1*
	USB Cable for Touch Panel Monitor Cable length: 2 m or 5 m	FH-VUAB

* Insert the cables length into □□□ in the model number as follows. 2 m = 200, 5 m = 500, 10 m = 010.

A video signal cable and an operation signal cable are required to connect the Touch Panel Monitor.

Signal	Cable	2 m	5 m	10 m
Video signal	DVI-Analog Conversion Cable	Yes	Yes	Yes
Touch panel operation signal	USB Cable	Yes	Yes	No
	RS-232C Cable	Yes	Yes	Yes

Parallel I/O Cables/Encoder Cable

Item	Descriptions	Model
	Parallel I/O Cable *1 Cable length: 2 m or 5 m	XW2Z-S013-□ *2
	Parallel I/O Cable for Connector-terminal Conversion Unit *1 Cable length: 0.5 m, 1 m, 1.5 m, 2 m, 3 m, 5 m Connector-Terminal Block Conversion Units can be connected (Terminal Blocks Recommended Products: OMRON XW2R-□□34G-T)	XW2Z-□□□EE *3
	Connector-Terminal Block Conversion Units, General-purpose devices	XW2R-□□34G-T *4
	Encoder Cable for line-driver Cable length: 1.5 m	FH-VR

*1 2 Cables are required for all I/O signals.

*2 Insert the cables length into □ in the model number as follows. 2 m = 2, 5 m = 5

*3 Insert the cables length into □□□ in the model number as follows. 0.5 m = 050, 1 m = 100, 1.5 m = 150, 2 m = 200, 3 m = 300, 5 m = 500

*4 Insert the wiring method into □ in the model number as follows. Phillips screw = J, Slotted screw (rise up) = E, Push-in spring = P
 Refer to the XW2R Series catalog (Cat. No. G077) for details.

Recommended EtherCAT and EtherNet/IP Communications Cables

Use Straight STP (shielded twisted-pair) cable of category 5 or higher with double shielding (braiding and aluminum foil tape) for EtherCAT.
Use Straight or cross STP (shielded twisted-pair) cable of category 5 or higher for EtherNet/IP.

Item	Descriptions			Model	
	For EtherCAT	Standard type Cable with Connectors on Both Ends (RJ45/RJ45) Wire Gauge and Number of Pairs: AWG27, 4-pair Cable, Cable Sheath material: LSZH *1, Cable color: Blue, Yellow, or Green, Cables length: 0.2m, 0.3m, 0.5m, 1m, 1.5m, 2m, 3m, 5m, 7.5m, 10m, 15m, 20m		XS6W-6LSZH8SS□CM-Y *2	
		Rugged type Cable with Connectors on Both Ends (RJ45/RJ45) Wire Gauge and Number of Pairs: AWG22, 2-pair Cable Cables length: 0.3m, 0.5m, 1m, 2m, 3m, 5m, 10m, 15m		XS5W-T421-□MD-K *2	
		Rugged type Cable with Connectors on Both Ends (M12/RJ45) Wire Gauge and Number of Pairs: AWG22, 2-pair Cable Cables length: 0.3m, 0.5m, 1m, 2m, 3m, 5m, 10m, 15m		XS5W-T421-□MC-K *2	
		Rugged type Cable with Connectors on Both Ends (M12 L/RJ45) Wire Gauge and Number of Pairs: AWG22, 2-pair Cable Cables length: 0.3m, 0.5m, 1m, 2m, 3m, 5m, 10m, 15m		XS5W-T422-□MC-K *2	
--	For EtherCAT and EtherNet/IP	Wire Gauge and Number of Pairs: AWG24, 4-pair Cable	Cables	Hitachi Metals, Ltd.	NETSTAR-C5E SAB 0.5 × 4P *3
--				Kuramo Electric Co.	KETH-SB *3
--				SWCC Showa Cable Systems Co.	FAE-5004 *3
--			RJ45 Connectors	Panduit Corporation	MPS588-C *3
--		Wire Gauge and Number of Pairs: AWG22, 2-pair Cable	Cables	Kuramo Electric Co. Nihon Electric Wire&Cable Co.,Ltd.	KETH-PSB-OMR *4 PNET/B *4
			RJ45 Assembly Connector	OMRON	XS6G-T421-1 *4
--	For EtherNet/IP	Wire Gauge and Number of Pairs: 0.5 mm, 4-pair Cable	Cables	Fujikura Ltd.	F-LINK-E 0.5mm × 4P *5
--				RJ45 Connectors	Panduit Corporation

Note: Please be careful while cable processing, for EtherCAT, connectors on both ends should be shield connected and for EtherNet/IP, connectors on only one end should be shield connected.

*1 The lineup features Low Smoke Zero Halogen cables for in-cabinet use and PUR cables for out-of-cabinet use.

*2 For details, refer to Cat.No.G019.

*3 We recommend you to use above cable for EtherCAT and EtherNet/IP, and RJ45 Connector together.

*4 We recommend you to use above cable for EtherCAT and EtherNet/IP, and RJ45 Assembly Connector together.

*5 We recommend you to use above cable For EtherNet/IP and RJ45 Connectors together.

Automation Software Sysmac Studio

Please purchase a DVD and licenses the first time you purchase the Sysmac Studio. DVDs and licenses are available individually. The license does not include the DVD.

Product	Specifications			Model
		Number of licenses	Media	
Sysmac Studio Standard Edition Ver.1.□□	The Sysmac Studio is the software that provides an integrated environment for setting, programming, debugging and maintenance of machine automation controllers including the NJ Series, EtherCat Slave, and the HMI. Sysmac Studio runs on the following OS. Windows XP (Service Pack 3 or higher, 32-bit version) / Windows Vista (32-bit version) / Windows 7 (32-bit/64-bit version) / Windows 8 (32-bit/64-bit version) / Windows 8.1 (32-bit/64-bit version)	-- (Media only)	DVD *1	SYSMAC-SE200D
		1 license	--	SYSMAC-SE201L
		3 license	--	SYSMAC-SE203L
		10 license	--	SYSMAC-SE210L
		30 license	--	SYSMAC-SE230L
		50 license	--	SYSMAC-SE250L
Sysmac Studio Vision Edition Ver.1.□□ *2 *3	Sysmac Studio Vision Edition is a limited license that provides selected functions required for FH-series/FQ-M-series Vision Sensor settings.	1 license	--	SYSMAC-VE001L

Note: 1. Site licenses are available for users who will run Sysmac Studio on multiple computers. Ask your OMRON sales representative for details.

2. Sysmac Studio version 1.07 or higher supports the FH Series. Sysmac Studio does not support the FZ5 Series.

*1 The same media is used for both the Standard Edition and the Vision Edition.

*2 With the Vision Edition, you can use only the setup functions for FH-series/FQ-M-series Vision Sensors.











*3 This product is a license only. You need the Sysmac Studio Standard Edition DVD media to install it.

Development Environment

Please purchase a CD-ROM and licenses the first time you purchase the Application Producer. CD-ROMs and licenses are available individually. The license does not include the CD-ROM.

Product	Specifications	Number of Model Standards licenses	Media	Model
		Application Producer	Software components that provide a development environment to further customize the standard controller features of the FH Series. System requirements: <ul style="list-style-type: none"> • CPU: Intel Pentium Processor (SSE2 or higher) • OS: Windows 7 Professional (32/64bit) or Enterprise(32/64bit) or Ultimate (32/64bit), Windows 8 Pro(32/64bit) or Enterprise(32/64bit), Windows 8.1 Pro(32/64bit) or Enterprise(32/64bit) • .NET Framework: .NET Framework 3.5 or higher • Memory: At least 2 GB RAM • Available disk space: At least 2 GB • Browser: Microsoft® Internet Explorer 6.0 or later • Display: XGA (1024 × 768), True Color (32-bit) or higher • Optical drive: CD/DVD drive The following software is required to customize the software: Microsoft® Visual Studio® 2010 Professional or Microsoft® Visual Studio® 2008 Professional or Microsoft® Visual Studio® 2012 Professional	– (Media only)
		1 license	–	FH-AP1L

Accessories











Item	Descriptions				Model	
	LCD Monitor 8.4 inches For Box-type Controllers*1				FZ-M08	
	LED Monitor Cable Cable length: 2 m or 5 m (When you connect a LCD Monitor FZ-M08 to FH sensor controller, please use it in combination with a DVI-I -RGB Conversion Connector FH-VMRGB.)				FZ-VM	
	DVI-I -RGB Conversion Connector				FH-VMRGB	
	USB Memory	2 GB			FZ-MEM2G	
		8 GB			FZ-MEM8G	
	SD Card	2 GB			HMC-SD291	
		4 GB			HMC-SD491	
	Display/USB Switcher				FZ-DU	
–	Mouse Recommended Products Driverless wired mouse (A mouse that requires the mouse driver to be installed is not supported.)				---	
	EtherCAT junction slaves	3 port	Power supply voltage: 20.4 to 28.8 VDC (24 VDC -15 to 20%)	Current consumption: 0.08 A	GX-JC03	
		6 port		Current consumption: 0.17 A	GX-JC06	
	Industrial Switching Hubs for EtherNet/IP and Ethernet	3 port	Failure detection: None	Current consumption: 0.08 A	W4S1-03B	
		5 port		Failure detection: None	Current consumption: 0.12 A	W4S1-05B
		5 port		Failure detection: Supported		W4S1-05C
–	Calibration Plate				FZD-CAL	
–	External Lighting			–	FLV Series *2 FL Series *2	
	Lighting Controller (Required to control external lighting from a Controller)	For FLV-Series		Camera Mount Light- ing Controller	FLV-TCC Series *2	
		For FLV-Series		Analog Lighting Con- troller	FLV-ATC Series *2	
		For FL-Series		Camera Mount Light- ing Controller	FL-TCC Series *2	
	For Intelligent Compact Camera			Mounting Bracket	FQ-XL	
				Mounting Brackets	FQ-XL2	
				Polarizing Filter At- tachment	FQ-XF1	
–	Mounting Bracket for FZ-S□				FZ-S-XLC	
	Mounting Bracket for FZ-S□2M				FZ-S2M-XLC	
	Mounting Bracket for FZ-SH□				FZ-SH-XLC	
	Mounting Bracket for FH-S□, FZ-S□5M2				FH-SM-XLC	
	Mounting Bracket for FH-S□12				FH-SM12-XLC	

*1 It can be used in FH series.









*2 Refer to the Vision Accessory Catalog (Cat. No. Q198) for details.

Lenses







C-mount Lens for 1/3-inch image sensor (Recommend: FZ-S□/FZ-SH□/FH-S□)

Model	3Z4S-LE SV-03514V	3Z4S-LE SV-04514V	3Z4S-LE SV-0614V	3Z4S-LE SV-0813V	3Z4S-LE SV-1214V	3Z4S-LE SV-1614V	3Z4S-LE SV-2514V	3Z4S-LE SV-3518V	3Z4S-LE SV-5018V	3Z4S-LE SV-7527V	3Z4S-LE SV-10035V
Appearance/Dimensions (mm)											
Focal length	3.5 mm	4.5 mm	6 mm	8 mm	12 mm	16 mm	25 mm	35 mm	50 mm	75 mm	100 mm
Aperture (F No.)	1.4 to Close	1.4 to Close	1.4 to Close	1.3 to Close	1.4 to Close	1.4 to Close	1.4 to Close	1.8 to Close	1.8 to Close	2.7 to Close	3.5 to Close
Filter size	—	—	M27.0 P0.5	M25.5 P0.5	M27.0 P0.5	M27.0 P0.5	M27.0 P0.5	M27.0 P0.5	M30.5 P0.5	M30.5 P0.5	M30.5 P0.5
Maximum sensor size	1/3 inch	1/3 inch	1/3 inch	1/3 inch	1/3 inch	1/3 inch	1/3 inch	1/3 inch	1/3 inch	1/3 inch	1/3 inch
Mount	C mount										







C-mount Lens for 2/3-inch image sensor (Recommend: FZ-S□2M/FZ-S□5M2) (3Z4S-LE SV-7525H and 3Z4S-LE SV-10028H can also be used for FH-S□02 and FH-S□04)

Model	3Z4S-LE SV-0614H	3Z4S-LE SV-0814H	3Z4S-LE SV-1214H	3Z4S-LE SV-1614H	3Z4S-LE SV-2514H	3Z4S-LE SV-3514H	3Z4S-LE SV-5014H	3Z4S-LE SV-7525H	3Z4S-LE SV-10028H
Appearance/Dimensions (mm)									
Focal length	6 mm	8 mm	12 mm	16 mm	25 mm	35 mm	50 mm	75 mm	100 mm
Aperture (F No.)	1.4 to 16	1.4 to 16	1.4 to 16	1.4 to 16	1.4 to 16	1.4 to 16	1.4 to 16	2.5 to Close	2.8 to Close
Filter size	M40.5 P0.5	M35.5 P0.5	M27.0 P0.5	M27.0 P0.5	M27.0 P0.5	M35.5 P0.5	M40.5 P0.5	M34.0 P0.5	M37.5 P0.5
Maximum sensor size	2/3 inch	2/3 inch	2/3 inch	2/3 inch	2/3 inch	2/3 inch	2/3 inch	1 inch	1 inch
Mount	C mount								

C-mount Lens for 1-inch image sensor (Recommend: FH-S□02/FH-S□04) (3Z4S-LE SV-7525H with focal length of 75 mm and 3Z4S-LE SV-10028H with focal length of 100 mm are also available.)

Model	3Z4S-LE VS-0618H1	3Z4S-LE VS-0814H1	3Z4S-LE VS-1214H1	3Z4S-LE VS-1614H1N	3Z4S-LE VS-2514H1	3Z4S-LE VS-3514H1	3Z4S-LE VS-5018H1
Appearance/Dimensions (mm)							
Focal length	6 mm	8 mm	12 mm	16 mm	25 mm	35 mm	50 mm
Aperture (F No.)	1.8 to 16	1.4 to 16	1.4 to 16	1.4 to 16	1.4 to 16	1.4 to 16	1.8 to 16
Filter size	Can not be used a filter	M55.0 P0.75	M35.5 P0.5	M30.5 P0.5	M30.5 P0.5	M30.5 P0.5	M40.5 P0.5
Maximum sensor size	1 inch	1 inch	1 inch	1 inch	1 inch	1 inch	1 inch
Mount	C mount						

M42-mount Lens for large image sensor (Recommend: FH-S□12)

Model	3Z4S-LE VS-L1828/M42-10	3Z4S-LE VS-L2526/M42-10	3Z4S-LE VS-L3528/M42-10	3Z4S-LE VS-L5028/M42-10	3Z4S-LE VS-L8540/M42-10	3Z4S-LE VS-L10028/M42-10
Appearance/Dimensions (mm)						
Focal length	18 mm	25 mm	35 mm	50 mm	85 mm	100 mm
Aperture (F No.)	2.8 to 16	2.6 to 16	2.8 to 16	2.8 to 16	4.0 to 16	2.8 to 16
Filter size	M55.0 P0.75	M55.0 P0.75	M62.0 P0.75	M62.0 P0.75	M52.0 P0.75	M52.0 P0.75
Maximum sensor size	1.8 inch					
Mount	M42 mount					



Lenses for small camera



Model	FZ-LES3	FZ-LES6	FZ-LES16	FZ-LES30
Appearance/Dimensions (mm)				
Focal length	3 mm	6 mm	16 mm	30 mm
Aperture (F No.)	2.0 to 16	2.0 to 16	3.4 to 16	3.4 to 16



Vibrations and Shocks Resistant C-mount Lens for 2/3-inch image sensor

(Recommend: FZ-S□/FZ-S□2M/FZ-S□5M2/FZ-SH□/FH-S□)

(Vibrations and Shocks Resistant Lenses for 1-inch image sensors and for large image sensors are also available. Ask your OMRON representative for details.)

Model	3Z4S-LE VS-MC15-□□□□□ *1									3Z4S-LE VS-MC20-□□□□□ *1								
Appearance/ Dimensions (mm)																		
Focal length	15 mm									20 mm								
Filter size	M27.0 P0.5									M27.0 P0.5								
Optical magnification	0.03 ×			0.2 ×			0.3 ×			0.04 ×			0.25 ×			0.4 ×		
Aperture (fixed F No.) *2	2	5.6	8	2	5.6	8	2	5.6	8	2	5.6	8	2	5.6	8	2	5.6	8
Depth of field (mm) *3	183.1	512.7	732.4	4.8	13.4	19.2	2.3	6.5	9.2	110.8	291.2	416.0	3.4	9.0	12.8	1.5	3.9	5.6
Maximum sensor size	2/3 inch																	
Mount	C Mount																	

Model	3Z4S-LE VS-MC25N-□□□□□ *1									3Z4S-LE VS-MC30-□□□□□ *1								
Appearance/ Dimensions (mm)																		
Focal length	25 mm									30 mm								
Filter size	M27.0 P0.5									M27.0 P0.5								
Optical magnification	0.05 ×			0.25 ×			0.5 ×			0.06 ×			0.15 ×			0.45 ×		
Aperture (fixed F No.) *2	2	5.6	8	2	5.6	8	2	5.6	8	2	5.6	8	2	5.6	8	2	5.6	8
Depth of field (mm) *3	67.2	188.2	268.8	3.2	9.0	12.8	1.0	2.7	3.8	47.1	131.9	188.4	8.2	22.9	32.7	1.1	3.2	4.6
Maximum sensor size	2/3 inch																	
Mount	C Mount																	

Model	3Z4S-LE VS-MC35-□□□□□ *1									3Z4S-LE VS-MC50-□□□□□ *1								
Appearance/ Dimensions (mm)																		
Focal length	35 mm									50 mm								
Filter size	M27.0 P0.5									M27.0 P0.5								
Optical magnification	0.26 ×			0.3 ×			0.65 ×			0.08 ×			0.2 ×			0.48 ×		
Aperture (fixed F No.) *2	1.9	5.6	8	1.9	5.6	8	1.9	5.6	8	2	5.6	8	2	5.6	8	2	5.6	8
Depth of field (mm) *3	2.8	8.4	11.9	2.2	6.5	9.2	0.6	1.7	2.5	33.8	75.6	108.0	6.0	13.4	19.2	1.3	2.9	4.1
Maximum sensor size	2/3 inch																	
Mount	C Mount																	

Model	3Z4S-LE VS-MC75-□□□□□ *1								
Appearance/ Dimensions (mm)									
Focal length	75 mm								
Filter size	M27.0 P0.5								
Optical magnification	0.14 ×			0.2 ×			0.62 ×		
Aperture (fixed F No.) *2	3.8	5.6	8	3.8	5.6	8	3.8	5.6	8
Depth of field (mm) *3	17.7	26.1	37.2	9.1	13.4	19.2	1.3	1.9	2.7
Maximum sensor size	2/3 inch								
Mount	C Mount								

*1 Insert the iris range into □□□□□ in the model number as follows.

- F=1.9 to 3.8: blank
- F=5.6: FN056
- F=8: FN080

*2 F-number can be selected from maximum aperture, 5.6, and 8.0.

*3 When circle of least confusion is 40 μm.

Extension Tubes

Lenses	For M42 mount Lenses *	For C mount Lenses *	For Small Digital CCD Cameras
Model	3Z4S-LE VS-EXR/M42	3Z4S-LE SV-EXR	FZ-LESR
Contents	Set of 5 tubes (20 mm, 10 mm, 8 mm, 2 mm, and 1 mm) Maximum outer diameter: 47.5 mm dia.	Set of 7 tubes (40 mm, 20 mm, 10 mm, 5 mm, 2.0 mm, 1.0 mm, and 0.5 mm) Maximum outer diameter: 30 mm dia.	Set of 3 tubes (15 mm, 10 mm, 5 mm) Maximum outer diameter: 12 mm dia.

* Do not use the 0.5-mm, 1.0-mm, and 2.0-mm Extension Tubes attached to each other. Since these Extension Tubes are placed over the threaded section of the Lens or other Extension Tube, the connection may loosen when more than one 0.5-mm, 1.0-mm or 2.0-mm Extension Tube are used together. Reinforcement is required to protect against vibration when Extension Tubes exceeding 30 mm are used. When using the Extension Tube, check it on the actual device before using it.

FH-Series

Ratings and Specifications (FH Sensor Controllers)

Type		High-speed Controllers (4 core)			Standard Controllers (2 core)				
Model	NPN PNP	FH-3050	FH-3050-10	FH-3050-20	FH-1050	FH-1050-10	FH-1050-20		
Main functions	Controller type		Box-type controllers						
	No. of Cameras		2	4	8	2	4	8	
	Connected Camera		Can be connected to all cameras. (FZ-S series/FH-S series)		Can be connected to all cameras. (FZ-S series/FH-S series) (Can be connected to up to four 12 million-pixel cameras or up to eight cameras other than 12 million-pixel cameras.)	Can be connected to all cameras. (FZ-S series/FH-S series)		Can be connected to all cameras. (FZ-S series/FH-S series) (Can be connected to up to four 12 million-pixel cameras or up to eight cameras other than 12 million-pixel cameras.)	
	Processing resolution (FZ-S)	When connected to a intelligent compact camera		752 (H) × 480 (V)					
		When connected to a 300,000-pixel camera		640 (H) × 480 (V)					
		When connected to a 2 million-pixel camera		1600 (H) × 1200 (V)					
		When connected to a 5 million-pixel camera		2448 (H) × 2044 (V)					
	Processing resolution (FH-S)	When connected to a 300,000-pixel camera		640 (H) × 480 (V)					
		When connected to a 2 million-pixel camera		2040 (H) × 1088 (V)					
		When connected to a 4 million-pixel camera		2040 (H) × 2048 (V)					
		When connected to a 12 million-pixel camera		4084 (H) × 3072 (V)					
	No. of scenes		128						
	Number of logged images *1	When connected to a intelligent compact camera		Connected to 1 camera(Color): 232, Connected to 2 camera(Color): 116 Connected to 3 camera(Color): 77, Connected to 4 camera(Color): 58 Connected to 5 camera(Color): 46, Connected to 6 camera(Color): 38 Connected to 7 camera(Color): 33, Connected to 8 camera(Color): 29					
		When connected to a 300,000-pixel camera (FZ-S/FH-S)		Connected to 1 camera(Color): 270, Connected to 1 camera(Monochrome): 272 Connected to 2 camera(Color): 135, Connected to 2 camera(Monochrome): 136 Connected to 3 camera(Color/Monochrome): 90 Connected to 4 camera(Color): 67, Connected to 4 camera(Monochrome): 68 Connected to 5 camera(Color/Monochrome): 54 Connected to 6 camera(Color/Monochrome): 45 Connected to 7 camera(Color/Monochrome): 38 Connected to 8 camera(Color): 33, Connected to 8 camera(Monochrome): 34					
		When connected to a 2 million-pixel camera (FH-S)		Connected to 1 camera(Color/Monochrome): 37, Connected to 2 camera(Color/Monochrome): 18 Connected to 3 camera(Color/Monochrome): 12, Connected to 4 camera(Color/Monochrome): 9 Connected to 5 camera(Color/Monochrome): 7, Connected to 6 camera(Color/Monochrome): 6 Connected to 7 camera(Color/Monochrome): 5, Connected to 8 camera(Color/Monochrome): 4					
		When connected to a 2 million-pixel camera (FZ-S)		Connected to 1 camera(Color/Monochrome): 43, Connected to 2 camera(Color/Monochrome): 21 Connected to 3 camera(Color/Monochrome): 14, Connected to 4 camera(Color/Monochrome): 10 Connected to 5 camera(Color/Monochrome): 8, Connected to 6 camera(Color/Monochrome): 7 Connected to 7 camera(Color/Monochrome): 6, Connected to 8 camera(Color/Monochrome): 5					
		When connected to a 4 million-pixel camera (FH-S)		Connected to 1 camera(Color/Monochrome): 20, Connected to 2 camera(Color/Monochrome): 10 Connected to 3 camera(Color/Monochrome): 6, Connected to 4 camera(Color/Monochrome): 5 Connected to 5 camera(Color/Monochrome): 4, Connected to 6 camera(Color/Monochrome): 3 Connected to 7 camera(Color/Monochrome): 2, Connected to 8 camera(Color/Monochrome): 2					
		When connected to a 5 million-pixel camera (FZ-S)		Connected to 1 camera(Color/Monochrome): 16, Connected to 2 camera(Color/Monochrome): 8 Connected to 3 camera(Color/Monochrome): 5, Connected to 4 camera(Color/Monochrome): 4 Connected to 5 camera(Color/Monochrome): 3, Connected to 6 camera(Color/Monochrome): 2 Connected to 7 camera(Color/Monochrome): 2, Connected to 8 camera(Color/Monochrome): 2					
		When connected to a 12 million-pixel camera (FH-S)		Connected to 1 camera(Color/Monochrome): 6, Connected to 2 camera(Color/Monochrome): 3 Connected to 3 camera(Color/Monochrome): 2, Connected to 4 camera(Color/Monochrome): 2					
	Operation		Mouse or similar device						
	Settings		Create series of processing steps by editing the flowchart (Help messages provided).						
	External interface	Serial communications		RS-232C: 1 CH					
		Ethernet communications		No-protocol (TCP/UDP) 1000BASE-T					
				1 port	2 port	2 port	1 port	2port	2port
		Ethernet/IP communications		Ethernet port baud rate: 1 Gbps (1000 BASE-T)					
EtherCAT communications		EtherCAT protocol (100BASE-TX)							
Parallel I/O		(In the 2-line random trigger mode) 17 inputs (STEP0/ENCTRIG_Z0, STEP1/ENCTRIG_Z1, ENCTRIG_A0 to 1, ENCTRIG_B0 to 1, DSA0 to 1, DIO to 7, DL_LINE0) 37 outputs (RUN0 to 1, READY0 to 1, BUSY0 to 1, OR0 to 1, ERROR0 to 1, GATE0 to 1, STGOUT0/SHTOUT0, STGOUT1/SHTOUT1, STGOUT2 to 7, DOO to 15, ACK) (In the 5-line to 8-line random trigger mode) 19 inputs, STEP0 to 7, DL_LINE0 to 2, DIO to 7) 34 outputs (READY0 to 7, BUSY0 to 7, OR0 to 7, ACK, ERROR, STGOUT/SHTOUT0 to 7)							
Encoder interface		RS422-A line driver level. Phase A/B: single-phase 4MHz (multiplying phase difference of 1MHz by 4 times), Phase Z: 1MHz							
Monitor interface		DVI-I (Single Link) output IF × 1ch							
USB interface		4 channels (supports USB 1.1 and 2.0)							
SD card interface		SDHC card of Class4 or higher rating is recommended.							
Ratings	Power supply voltage		20.4 to 26.4 VDC						
	Current consumption (at 24.0 VDC) *2	When connected to a intelligent compact camera	Connected to 2 cameras	5.0 A max.	5.4 A max.	6.4 A max.	4.7 A max.	5.0 A max.	5.9 A max.
			Connected to 4 cameras	—	7.0 A max.	8.1 A max.	—	6.5 A max.	7.5 A max.
		When connected to a 300,000-pixel camera, 2 million-pixel camera, 4 million-pixel camera, 5 million-pixel camera or 12 million-pixel camera	Connected to 2 cameras	4.1 A max.	4.2 A max.	5.2 A max.	3.6 A max.	3.7 A max.	4.5 A max.
			Connected to 4 cameras	—	4.8 A max.	5.6 A max.	—	4.3 A max.	5.0 A max.
			Connected to 8 cameras	—	—	6.8 A max.	—	—	6.2 A max.
Insulation resistance		Between DC power supply and controller FG: 20 MΩ or higher (rated voltage 250 V)							
Operation Environment	Noise Immunity	Fast transient burst	DC Power Supply						
			I/O line						
	Ambient temperature range		Direct infusion: 2 KV Pulse rising: 5 ns Pulse width: 50 ns Burst continuation time: 15 ms/0.75 ms Period: 300 ms Application time: 1 min Cramp: 1 KV Pulse rising: 5 ns Pulse width: 50 ns Burst continuation time: 15 ms/0.75 ms Period: 300 ms Application time: 1 min						
	Ambient humidity range		Operating and storage: 35% to 85% (with no condensation)						
	Ambient atmosphere		No corrosive gases						
Dimensions	Grounding		Type D grounding (100Ω or less grounding resistance) Conventional type 3 grounding						
	Degree of protection		IEC60529 IP20						
	Dimensions		190 × 115 × 182.5 mm						
Dimensions	Weight		Approx. 3.2 kg	Approx. 3.4 kg	Approx. 3.4 kg	Approx. 3.2 kg	Approx. 3.4 kg	Approx. 3.4 kg	
	Case materials		Cover: zinc-plated steel plate, side plate: aluminum (A6063)						
Accessories		Controller (1) / user manual (one Japanese and one English versions) / Instruction Installation Manual (1) / Power supply terminal block connector (1) / Ferrite core (2, FH-3050 and FH-1050), 4 (FH-3050-10 and FH-1050-10), and 8 (FH-3050-20 and FH-1050-20)							

*1 The image logging capacity changes when multiple cameras of different types are connected at the same time.

*2 The current consumption when the maximum number of cameras supported by each controller are connected.

If a lighting controller model is connected to a lamp, the current consumption is as high as when an intelligent compact camera is connected.

Ratings and Specifications (Cameras)

High-speed CMOS cameras

Model	FH-SM	FH-SC	FH-SM02	FH-SC02	FH-SM04	FH-SC04	FH-SM12	FH-SC12
Image elements	CMOS image elements (1/3-inch equivalent)		CMOS image elements (2/3-inch equivalent)		CMOS image elements (1-inch equivalent)		CMOS image elements (1.76-inch equivalent)	
Color/Monochrome	Monochrome	Color	Monochrome	Color	Monochrome	Color	Monochrome	Color
Effective pixels	640 (H) × 480 (V)		2040 (H) × 1088 (V)		2040 (H) × 2048 (V)		4084 (H) × 3072 (V)	
Imaging area H × V (opposing corner)	4.8 × 3.6 (6.0 mm)		11.26 × 5.98 (12.76 mm)		11.26 × 11.26 (15.93 mm)		22.5 × 16.9 (28.14 mm)	
Pixel size	7.4 (μm) × 7.4 (μm)		5.5 (μm) × 5.5 (μm)		5.5 (μm) × 5.5 (μm)		5.5 (μm) × 5.5 (μm)	
Shutter function	Electronic shutter; Shutter speeds can be set from 20 μs to 100 ms.		Electronic shutter; Shutter speeds can be set from 25 μs to 100 ms.				Electronic shutter; Shutter speeds can be set from 60 μs to 100 ms.	
Partial function	1 to 480 lines	2 to 480 lines	1 to 1088 lines	2 to 1088 lines	1 to 2048 lines	2 to 2048 lines	4 to 3072 lines (4-line increments)	
Frame rate (Image Acquisition Time)	308 fps (3.3 ms)		219 fps (4.6 ms) *		118 fps (8.5 ms) *		38.9 fps (25.7 ms) *	
Lens mounting	C mount						M42 mount	
Field of vision, installation distance	Selecting a lens according to the field of vision and installation distance							
Ambient temperature range	Operating: 0 to 40 °C, Storage: -25 to 65 °C (with no icing or condensation)							
Ambient humidity range	Operating and storage: 35% to 85% (with no condensation)							
Weight	Approx.105 g		Approx.110 g				Approx.320 g	
Accessories	Instruction manual							

* Frame rate in high speed mode when the camera is connected using two camera cables.

Digital CCD Cameras

Model	FZ-S	FZ-SC	FZ-S2M	FZ-SC2M	FZ-S5M2	FZ-SC5M2
Image elements	Interline transfer reading all pixels, CCD image elements (1/3-inch equivalent)		Interline transfer reading all pixels, CCD image elements (1/1.8-inch equivalent)		Interline transfer reading all pixels, CCD image elements (2/3-inch equivalent)	
Color/Monochrome	Monochrome	Color	Monochrome	Color	Monochrome	Color
Effective pixels	640 (H) × 480 (V)		1600 (H) × 1200 (V)		2448 (H) × 2044 (V)	
Imaging area H × V (opposing corner)	4.8 × 3.6 (6.0mm)		7.1 × 5.4 (8.9mm)		8.4 × 7.1 (11mm)	
Pixel size	7.4 (μm) × 7.4 (μm)		4.4 (μm) × 4.4 (μm)		3.45 (μm) × 3.45 (μm)	
Shutter function	Electronic shutter; select shutter speeds from 20 μs to 100 ms					
Partial function	12 to 480 lines		12 to 1200 lines		12 to 2044 lines	
Frame rate (Image Acquisition Time)	80 fps (12.5 ms)		30 fps (33.3 ms)		16 fps (62.5 ms)	
Lens mounting	C mount					
Field of vision, installation distance	Selecting a lens according to the field of vision and installation distance					
Ambient temperature range	Operating: 0 to 50 °C Storage: -25 to 65 °C (with no icing or condensation)		Operating: 0 to 40 °C Storage: -25 to 65 °C (with no icing or condensation)			
Ambient humidity range	Operating and storage: 35% to 85% (with no condensation)					
Weight	Approx. 55 g		Approx. 76 g		Approx.140 g	
Accessories	Instruction manual					

Small CCD Digital Cameras

Model	FZ-SF	FZ-SFC	FZ-SP	FZ-SPC
Image elements	Interline transfer reading all pixels, CCD image elements (1/3-inch equivalent)			
Color/Monochrome	Monochrome	Color	Monochrome	Color
Effective pixels	640 (H) × 480 (V)			
Imaging area H × V (opposing corner)	4.8 × 3.6 (6.0mm)			
Pixel size	7.4 (μm) × 7.4 (μm)			
Shutter function	Electronic shutter; select shutter speeds from 20 μm to 100 ms			
Partial function	12 to 480 lines			
Frame rate (Image Acquisition Time)	80 fps (12.5ms)			
Lens mounting	Special mount (M10.5 P0.5)			
Field of vision, installation distance	Selecting a lens according to the field of vision and installation distance			
Ambient temperature range	Operating: 0 to 50 °C (camera amp) 0 to 45 °C (camera head) Storage: -25 to 65 °C (with no icing or condensation)			
Ambient humidity range	Operating and storage: 35% to 85% (with no condensation)			
Weight	Approx. 150 g			
Accessories	Instruction manual, installation bracket, Four mounting brackets (M2)		Instruction manual	

High-speed CCD Cameras

Model	FZ-SH	FZ-SHC
Image elements	Interline transfer reading all pixels, CCD image elements (1/3-inch equivalent)	
Color/Monochrome	Monochrome	Color
Effective pixels	640 (H) × 480 (V)	
Imaging area H x V (opposing corner)	4.8 × 3.6 (6.0mm)	
Pixel size	7.4 (μm) × 7.4 (μm)	
Shutter function	Electronic shutter; select shutter speeds from 1/10 to 1/50,000 s	
Partial function	12 to 480 lines	
Frame rate (Image Acquisition Time)	204 fps (4.9ms)	
Field of vision, installation distance	Selecting a lens according to the field of vision and installation distance	
Ambient temperature range	Operating: 0 to 40 °C Storage: -25 to 65 °C (with no icing or condensation)	
Ambient humidity range	Operating and storage: 35% to 85% (with no condensation)	
Weight	Approx. 105 g	
Accessories	Instruction manual	

Intelligent Compact CMOS Cameras

Model	FZ-SQ010F	FZ-SQ050F	FZ-SQ100F	FZ-SQ100N
Image elements	CMOS color image elements (1/3-inch equivalent)			
Color/Monochrome	Color			
Effective pixels	752 (H) × 480 (V)			
Imaging area H x V (opposing corner)	4.51 × 2.88 (5.35mm)			
Pixel size	6.0 (μm) × 6.0 (μm)			
Shutter function	1/250 to 1/32,258			
Partial function	8 to 480 lines			
Frame rate (Image Acquisition Time)	60 fps (16.7 ms)			
Field of vision	7.5 × 4.7 to 13 × 8.2 mm	13 × 8.2 to 53 × 33 mm	53 × 33 to 240 × 153 mm	29 × 18 to 300 × 191 mm
Installation distance	38 to 60 mm	56 to 215 mm	220 to 970 mm	32 to 380 mm
LED class *	Risk Group2			
Ambient temperature range	Operating: 0 to 50 °C Storage: -25 to 65 °C			
Ambient humidity range	Operating and storage: 35% to 85% (with no condensation)			
Weight	Approx. 150 g		Approx. 140 g	
Accessories	Mounting bracket (FQ-XL), polarizing filter attachment (FQ-XF1), instruction manual and warning label			

* Applicable standards: IEC62471-2

• Narrow View FZ-SQ010F

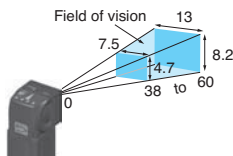

• Standard FZ-SQ050F

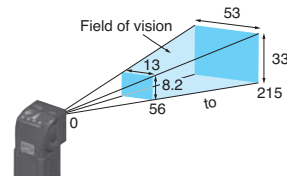

• Wide View (Long-distance) FZ-SQ100F

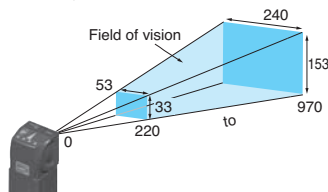

• Wide View (Short-distance) FZ-SQ100N

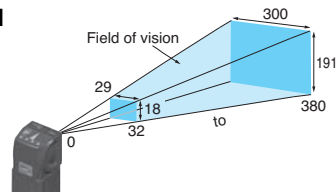

Ratings and Specifications (Cable, Monitor)

Camera Cables

Model	FZ-VS3 (2 m)	FZ-VSB3 (2 m)	FZ-VSL3 (2 m)	FZ-VSLB3 (2 m)
Shock resistiveness (durability)	10 to 150 Hz single amplitude 0.15 mm 3 directions, 8 strokes, 4 times			
Ambient temperature range	Operation and storage: 0 to 65 °C (with no icing or condensation)			
Ambient humidity range	Operation and storage: 40 to 70%RH (with no condensation)			
Ambient atmosphere	No corrosive gases			
Material	Cable sheath, connector: PVC			
Minimum bending radius	69mm	69mm	69mm	69mm
Weight	Approx. 170 g	Approx. 180 g	Approx. 170 g	Approx. 180 g

Cable Extension Unit

Model	FZ-VSJ
Power supply voltage *1	11.5 to 13.5 VDC
Current consumption *2	1.5 A max.
Ambient temperature range	Operating: 0 to 50 °C; Storage: -25 to 65 °C (with no icing or condensation)
Ambient humidity range	Operating and storage: 35 to 85% (with no condensation)
Weight	Approx. 240 g
Accessories	Instruction Sheet and 4 mounting screws

*1 A 12-VDC power supply must be provided to the Cable Extension Unit when connecting the Intelligent Compact Camera, or the Lighting Controller.

*2 The current consumption shows when connecting the Cable Extension Unit to an external power supply.

Long-distance Camera Cables

Model	FZ-VS4 (15 m)	FZ-VSL4 (15 m)
Shock resistiveness (durability)	10 to 150 Hz single amplitude 0.15 mm 3 directions, 8 strokes, 4 times	
Ambient temperature range	Operation and storage: 0 to 65 °C (with no icing or condensation)	
Ambient humidity range	Operation and storage: 40 to 70%RH (with no condensation)	
Ambient atmosphere	No corrosive gases	
Material	Cable sheath, connector: PVC	
Minimum bending radius	78 mm	
Weight	Approx. 1400 g	

Encoder Cable

Model	FH-VR
Vibration resistiveness	10 to 150 Hz single amplitude 0.1 mm 3 directions, 8 strokes, 10 times
Ambient temperature range	Operation: 0 to 50 °C; Storage: -10 to 60 °C (with no icing or condensation)
Ambient humidity range	Operation and storage: 35 to 85%RH (with no condensation)
Ambient atmosphere	No corrosive gases
Material	Cable Jacket: Heat, oil and flame resistant PVC Connector: polycarbonate resin
Minimum bending radius	65 mm
Weight	Approx. 104 g

Touch Panel Monitor

Model	FH-MT12	
Major Function	Display area	12.1 inch
	Resolution	1024 (V) × 768 (H)
	Number of color	16,700,000 colors (8 bit/color)
	Brightness	500cd/m ² (Typ)
	Contrast Ratio	600:1 (Typ)
	Viewing angle	Left and right: each 80°, upward: 80°, downward: 60°
	Backlight Unit	LED, edge-light
	Backlight lifetime	About 100,000hour
External interface	Touch panel	4wire resistive touch screen
	Video input	analog RGB
	Touch panel signal	USB RS-232C
Ratings	Power supply voltage	24 VDC (21.6 to 26.4 VDC)
	Current consumption	Between DC power supply and touch panel monitor
	Insulation resistance	FG: 20 MΩ or higher (rated voltage 250 V)
Operating environment	Ambient temperature range	Operating: 0 to 50°C, Storage: -20 to +65°C (with no icing or condensation)
	Ambient humidity range	Operating and Storage: 20 to 85 %RH (with no icing or condensation)
	Ambient environment	No corrosive gas
	Vibration resistance	10 to 150 Hz, one-side amplitude 0.1 mm (Max. acceleration 15 m/s ²) 10 times for 8 minutes for each three direction
Operation	Degree of protection	Panel mounting: IP65 on the front
		Touch pen
Structure	Mounting	Panel mounting, VESA mounting
	Weight	Approx. 2.6 kg
	Material	Front panel: PC/PBT, Front Sheet: PET, Rear case: SUS

Note: FH Series Sensor Controllers version 5.32 or higher is required. It cannot be used in FZ series.

Touch Panel Monitor Cables

Model	FH-VMDA (2 m)	FH-VUAB (2 m)	XW2Z-200PP-1 (2 m)
Cable type	DVI-Analog Conversion Cable	USB Cable	RS-232C Cable
Vibration resistance	10 to 150 Hz, one-side amplitude 0.1 mm, 10 times for 8 minutes for each three direction		
Ambient Temperature	Operating Condition: 0 to 50°C, Storage Condition: -10 to 60°C (with no icing or condensation)		
Ambient Humidity	Operating Condition: 35 to 85%RH, Storage Condition: 35 to 85%RH (with no icing or condensation)		
Ambient environment	No corrosive gases		
Material	Cable outer sheath, Connector: PVC		Cable outer sheath: PVC, Connector: ABS/Ni Plating
Minimum bend radius	36 mm	25 mm	59 mm
Weight	Approx. 220 g	Approx. 75 g	Approx. 162 g

FH-Series

LCD Monitor

Model	FZ-M08
Size	8.4 inches
Type	Liquid crystal color TFT
Resolution	1,024 × 768 dots
Input signal	Analog RGB video input, 1 channel
Power supply voltage	21.6 to 26.4 VDC
Current consumption	Approx. 0.7 A max.
Ambient temperature range	Operating: 0 to 50 °C; Storage: -25 to 65 °C (with no icing or condensation)
Ambient humidity range	Operating and storage: 35 to 85% (with no condensation)
Weight	Approx. 1.2 kg
Accessories	Instruction Sheet and 4 mounting brackets

LED Monitor Cable

Model	FZ-VM
Vibration resistiveness	10 to 150 Hz single amplitude 0.15 mm 3 directions, 8 strokes, 4 times
Ambient temperature range	Operation: 0 to 50 °C; Storage: -20 to 65 °C (with no icing or condensation)
Ambient humidity range	Operation and storage: 35 to 85%RH (with no condensation)
Ambient atmosphere	No corrosive gases
Material	Cable sheath: heat-resistant PVC Connector: PVC
Minimum bending radius	75 mm
Weight	Approx. 170 g

Note: When you connect a LCD Monitor FZ-M08 to FH sensor controller, please use it in combination with a DVI-I -RGB Conversion Connector FH-VMRGB.

EtherCAT Communications Specifications

Item	Specifications	
Communications standard	IEC61158 Type 12	
Physical layer	100 BASE-TX (IEEE802.3)	
Modulation	Base band	
Baud rate	100 Mbps	
Topology	Depends on the specifications of the EtherCAT master.	
Transmission Media	Twisted-pair cable of category 5 or higher (double-shielded straight cable with aluminum tape and braiding)	
Transmission Distance	Distance between nodes: 100 m or less	
Node address setting	00 to 9	
External connection terminals	RJ45 × 2 (shielded) IN: EtherCAT input data, OUT: EtherCAT output data	
Send/receive PDO data sizes	Input	56 to 280 bytes/line (including input data, status, and unused areas) Up to 8 lines can be set. *
	Output	28 bytes/line (including output data and unused areas) Up to 8 lines can be set. *
Mailbox data size	Input	512 bytes
	Output	512 bytes
Mailbox	Emergency messages, SDO requests, and SDO information	
Refreshing methods	I/O-synchronized refreshing (DC)	

* This depends on the upper limit of the master.

Version Information

FH Series and Programming Devices

Use the latest version of Sysmac Studio Standard Edition/Vision Edition.

FH Series	Version of FH Series	Corresponding version of Sysmac Studio Standard Edition/Vision Edition
FH-3050 (-□) FH-1050 (-□)	Version 5.30	Supported by version 1.10.80 or higher.
	Version 5.20	Supported by version 1.10 or higher.
	Version 5.10	Supported by version 1.07.43 or higher.
	Version 5.00	Supported by version 1.07 or higher. Not supported by version 1.06 or lower.

Components and Functions

Example of the FH Sensor Controllers BOX type (4-camera type)

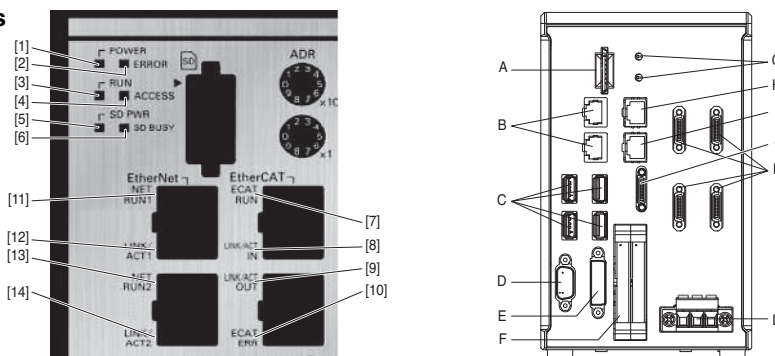

	Name	Description
[1]	POWER LED	Lit while power is ON.
[2]	ERROR LED	Lit when an error has occurred.
[3]	RUN LED	Lit while the controller is in Measurement Mode.
[4]	ACCESS LED	Lit while the memory is accessed.
[5]	SD POWER LED	Lit while power is supplied to the SD card and the card is usable.
[6]	SD BUSY LED	Blinks while the SD memory card is accessed.
[7]	EtherCAT RUN LED	Lit while EtherCAT communications are usable.
[8]	EtherCAT LINK/ACT IN LED	Lit when connected with an EtherCAT device, and blinks while performing communications.
[9]	EtherCAT LINK/ACT OUT LED	Lit when connected with an EtherCAT device, and blinks while performing communications.
[10]	EtherCAT ERR LED	Lit when EtherCAT communications have become abnormal.
[11]	EtherNet NET RUN1 LED	Lit while EtherNet communications are usable.
[12]	EtherNet NET LINK/ACK1 LED	Lit when connected with an EtherNet device, and blinks while performing communications.
[13]	EtherNet NET RUN2 LED	Lit when EtherNet communications are usable.
[14]	EtherNet NET LINK/ACK2 LED	Lit when connected with an EtherNet device, and blinks while performing communications.

	Name	Description
A	SD memory card installation connector	Install the SD memory card. Do not plug or unplug the SD card during measurement operation. Otherwise measurement time may be affected or data may be destroyed.
B	EtherNet connector	Connect an EtherNet device.
C	USB connector	Connect a USB device. Do not plug or unplug it during measurement operation. Otherwise measurement time may be affected or data may be destroyed.
D	RS-232C connector	Connect an external device such as a programmable controller.
E	DVI-I connector	Connect a monitor.
F	I/O connector (control lines, data lines)	Connect the controller to external devices such as a sync sensor and PLC.
G	EtherCAT address setup volume	Used to set a node address (00 to 99) as an EtherCAT communication device.
H	EtherCAT communication connector (IN)	Connect the opposed EtherCAT device.
I	EtherCAT communication connector (OUT)	Connect the opposed EtherCAT device.
J	Encoder connector	Connect an encoder.
K	Camera connector	Connect cameras.
L	Power supply terminal connector	Connect a DC power supply. Wire the controller independently on other devices. Wire the ground line. Be sure to ground the controller alone. Perform wiring using the attached power supply connector.

Example of the FZ5-Lite Sensor Controllers LCD-integrated type (4-camera type)

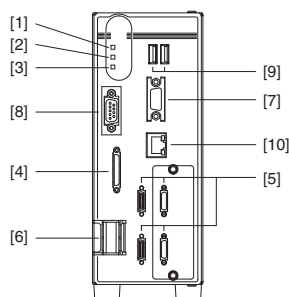

	Name	Description
[1]	POWER LED	Lit while power is ON.
[2]	RUN LED	Lit while the controller is in Run Mode.
[3]	ERROR LED	Lit when an error has occurred.
[4]	I/O connector (control lines, data lines)	Connect the controller to external devices such as a sync sensor and PLC.
[5]	Camera connector	Connect cameras.
[6]	Power	Connect a DC power supply. Wire the power supply unit independently of other devices. After wiring, replace the terminal cover.
[7]	Monitor connector (analog RGB)	Connect a monitor. (Provided with Lite controller type only)
[8]	RS-232C/RS-422 connector	Connect an external device such as a personal computer or PLC.
[9]	USB connector	Connect a track ball, mouse and USB memory. A total of four USB ports are provided and any of them can be used. However, when connecting two or more USB memories, do not connect them to adjacent ports. Doing so may cause the USB memories to come into contact, resulting in malfunction or damage.
[10]	EtherNet connector	Connect the controller to a personal computer.

Processing Items

Group	Icon	Processing Item	Corresponding Page in the Catalog
Measurement		Search Used to identify the shapes and calculate the position of measurement objects.	P16
		Flexible Search Recognizing the shapes of workpieces with variation and detecting their positions.	P16
		Sensitive Search Search a small difference by dividing the search model in detail, and calculating the correlation.	P16
		ECM Search Used to search the similar part of model form input image. Detect the evaluation value and position.	
		EC Circle Search Extract circles using "round " shape information and get position, radius and quantity in high preciseness.	
		Shape Search II Used to search the similar part of model from input image regardless of environmental changes. Detect the evaluation value and position.	P16
		Shape Search III Robust detection of positions is possible at high-speed and with high precision incorporating environmental fluctuations, such as differences in individual shapes of the workpieces, pose fluctuations, noise superimposition and shielding.	P16
		EC Corner This processing item measures a corner position (corner) of a workpiece.	
		Ec Cross The center position of a crosshair shape is measured using the lines created by the edge information on each side of the crosshair.	
		Classification Used when various kinds of products on the assembly line need to be sorted and identified.	P16
		Edge Position Measure position of measurement objects according to the color change in measurement area.	P16
		Edge Pitch Detect edges by color change in measurement area. Used for calculating number of pins of IC and connectors.	P16
		Scan Edge Position Measure peak/bottom edge position of workpieces according to the color change in separated measurement area.	P16
		Scan Edge Width Measure max/min/average width of workpieces according to the color change in separated measurement area.	P16
		Circular Scan Edge Position Measure center axis, diameter and radius of circular workpieces.	P16
		Circular Scan Edge Width Measure center axis, width and thickness of ring workpieces.	P16
		Intersection Calculate approximate lines from the edge information on two sides of a square workpiece to measure the angle formed at the intersection of the two lines.	P16
		Color Data Used for detecting presence and mixed varieties of products by using color average and deviation.	
		Gravity and Area Used to measure area, center of gravity of workpieces by extracting the color to be measured.	
		Labeling Used to measure number, area and gravity of workpieces by extracting registered color.	
		Label Data Selecting one region of extracted Labeling, and get that measurement. Area and Gravity position can be got and judged.	
		Defect Used for appearance measurement of plain-color measurement objects such as defects, stains and burrs.	P16
		Precise Defect Check the defect on the object. Parameters for extraction defect can be set precisely.	P16
		Fine Matching Difference can be detected by overlapping and comparing (matching) registered fine images with input images.	P16
		Character Inspect Recognize character according correlation search with model image registered in [Model Dictionary].	P17
		Date Verification Reading character string is verified with internal date.	P17
		Model Dictionary Register character pattern as dictionary. The pattern is used in [Character Inspection].	
		2DCode *2 Recognize 2D code and display where the code quality is poor.	P17
		Barcode *1 Recognize barcode, verify and output decoded characters.	P17
		OCR Recognize and read characters in images as character information.	P17
		OCR User Dictionary Register dictionary data to use for OCR.	P17
		Circle Angle Used for calculating angle of inclination of circular measurement objects.	
		Glue Bead Inspection You can inspect coating of a specified color for gaps or runoffs along the coating path.	P17
Input Image		To input images from cameras. And set up the conditions to input images from cameras. (To FZ5 Sensor Controllers only)	
		To input images from cameras. And set up the conditions to input images from cameras. (For FH Sensor Controllers only)	

Group	Icon	Processing Item	Corresponding Page in the Catalog	
Input Image		Camera Image Input HDR Create high-dynamic range images by acquiring several images with different conditions.		
		Camera Image Input HDRLite HDR function for FZ-SQ□ Intelligent Compact Cameras.		
		Camera Switch To switch the cameras used for measurement. Not input images from cameras again.		
		Measurement Image Switching To switch the images used for measurement. Not input images from camera again.		
Compensate image		Position Compensation Used when positions are differed. Correct measurement is performed by correcting position of input images.	P18	
		Filtering Used for processing images input from cameras in order to make them easier to be measured.	P18	
		Background Suppression To enhance contrast of images by extracting color in specified brightness.	P18	
		Brightness Correct Filter Track brightness change of entire screen and remove gradual brightness change such as uneven brightness.	P18	
		Color Gray Filter Color image is converted into monochrome images to emphasize specific color.	P18	
		Extract Color Filter Convert color image to color extracted image or binary image.	P18	
		Anti Color Shading To remove the irregular color/pattern by uniformizing max.2 specified colors.	P18	
		Stripes Removal Filter II Remove the background pattern of vertical, horizontal and diagonal stripes.	P19	
		Polar Transformation Rectify the image by polar transformation. Useful for OCR or pattern inspection printed on circle.	P18	
		Trapezoidal Correction Rectify the trapezoidal deformed image.	P18	
		Machine Simulator How the alignment marks would move on the image when each stage or robot axis is controlled can be checked.		
		Image Subtraction The registered model image and measurement image are compared and only the different pixels are extracted and converted to an image.		
		Advanced filter Process the images acquired from cameras in order to make them easier to measure. This processing item consolidates existing image conversion filtering into one processing item and adds extra functions.	P18	
		Panorama Combine multiple image to create one big image.	P18	
	Support measurement		Unit Macro Advanced arithmetic processing can be easily incorporated into workflow as Unit Macro processing items.	P20
			Unit Calculation Macro This function is convenient when the user wants to calculate a value using an original calculation formula or change the set value or system data of a processing item.	P20
			Calculation Used when using the judge results and measured values of Procltem which are registered in processing units.	
		Line Regression Used for calculating regression line from plural measurement coordinate.		
		Circle Regression Used for calculating regression circle from plural measurement coordinate.		
		Precise Calibration Used for calibration corresponding to trapezoidal distortion and lens distortion.	P15	
		User Data Used for setting of the data that can be used as common constants and variables in scene group data.	P21	
		Set Unit Data Used to change the Procltem data (setting parameters, etc.) that has been set up in a scene.		
		Get Unit Data Used to get one data (measured results, setting parameters, etc.) of Procltem that has been set up in a scene.		
		Set Unit Figure Used for re-setting the figure data (model, measurement area) registered in an unit.		
		Get Unit Figure Used for get the figure data (model, measurement area) registered in an unit.		
		Trend Monitor Used for displaying the information about results on the monitor, facilitating to avoid NG and analyze causes.	P21	
		Image Logging Used for saving the measurement images to the memory and USB memory.		
		Image Conversion Logging Used for saving the measurement images in JPEG and BMP format.		
		Data Logging Used for saving the measurement data to the memory and USB memory.		
	Elapsed Time Used for calculating the elapsed time since the measurement trigger input.			
	Wait Processing is stopped only at the set time. The standby time is set by the unit of [ms].			

Group	Icon	Processing Item	Corresponding Page in the Catalog	
Support measurement		Focus	Focus setting is supported.	P15
		Iris	Focus and aperture setting is supported.	P15
		Parallelize *3	A part of the measurement flow is divided into two or more tasks and processed in parallel to shorten the measurement time. This processing item is placed at the top of processing to be performed in parallel.	
		Parallelize Task *3	A part of the measurement flow is divided into two or more tasks and processed in parallel to shorten the measurement time. This processing item is placed immediately before processing to be performed in parallel between Parallelize and Parallelize End.	
		Statistics	Used when you need to calculate an average of multiple measurement results.	
		Reference Calib Data	Calibration data and distortion compensation data held under other processing items can be referenced.	
		Position Data Calculation	The specified position angle is calculated from the measured positions.	P14
		Stage Data	Sets and stores data related to stages.	
		Robot Data	Sets and stores data related to robots.	
		Vision Master Calibration	This processing item automatically calculates the entire axis movement amount of the control equipment necessary for calibration.	P15
		PLC Mastroer Calibration	Calibration data is created using a communication command from PLC.	P15
		Convert Position Data	The position angle after the specified axis movement is calculated.	P14
		Movement Single Position	The axis movement that is required to match the measured position angle to the reference position angle is calculated.	P14
		Movement Multi Points	The axis movements that are required to match the measured position angles to the corresponding reference position angles are calculated.	P14
		Detection Point	Obtains position/angle information by referring to the coordinate values measured with the Measurement Processing Unit.	
		Camera Calibration	By setting the camera calibration, the measurement result can be converted and output as actual dimensions.	P15
		Data Save	The set data can be saved in the controller main unit or as scene data. The data is held even after the FH/FZ power is turned off.	

Group	Icon	Processing Item	Corresponding Page in the Catalog	
Branch		Conditional Branch	Used where more than two kinds of products on the production line need to be detected separately.	
		End	This Proctem must be set up as the last processing unit of a branch.	
		DI Branch	Same as Proctem "Branch". But you can change the targets of conditional branching via external inputs.	
		Control Flow Normal	Set the measurement flow processing into the wait state in which the specific no-protocol command can be executed.	
		Control Flow PLC Link	Set the measurement flow processing into the wait state in which the specific PLC Link command can be executed.	
		Control Flow Parallel	Set the measurement flow processing into the wait state in which the specific parallel command can be executed.	
		Control Flow Fieldbus	Set the measurement flow processing into the wait state in which the specific Fieldbus command can be executed.	
Output results		Selective Branch	Easily branch to multiple destinations.	
		Data Output	Used when you need to output data to the external devices such as PLC or PC via serial ports.	
		Parallel Data Output	Used when you need to output data to the external devices such as PLC or PC via parallel ports.	
Output result		Parallel Judgement Output	Used when you need to output judgement results to the external devices such as PLC or PC via parallel ports.	
		Fieldbus Data Output	Outputs data to an external device, such as a Programmable Controller, through a fieldbus interface.	
		Result Display	Used for displaying the texts or the figures in the camera image.	
Output result		Display Image File	Display selected image file.	
		Display Last NG Image	Display the last NG images.	

*1 Bar Codes that can be read : JAN/EAN/UPC (including add-on codes), Code 39, Codabar (NW-7), ITF (Interleaved 2 of 5), Code 93, Code 128, GS1-128, GS1 DataBar (RSS-14 / RSS Limited / RSS Expanded), Pharmacode

*2 2D Codes that can be read : Data Matrix (ECC200), QR Code

*3 FZ5-L3□□ controllers do not support.

Dimensions

(Unit: mm)

Sensor Controllers

FH-series Box-type
 FH-3050/-3050-10/-3050-20
 FH-1050/-1050-10/-1050-20

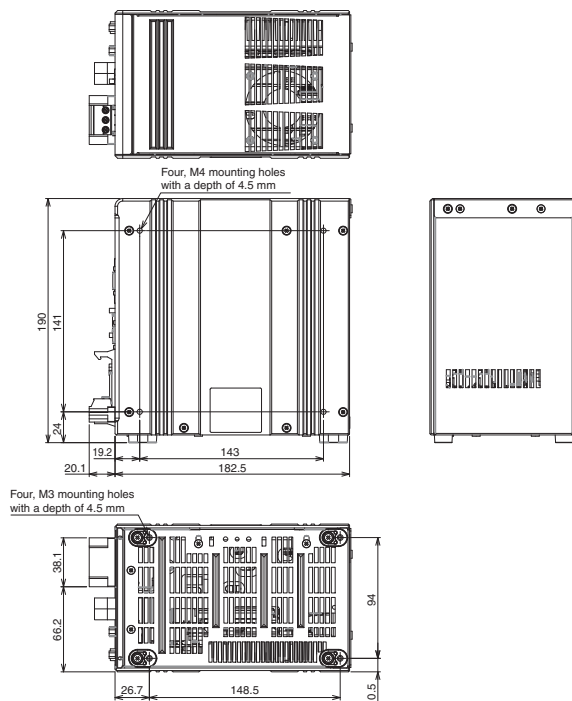
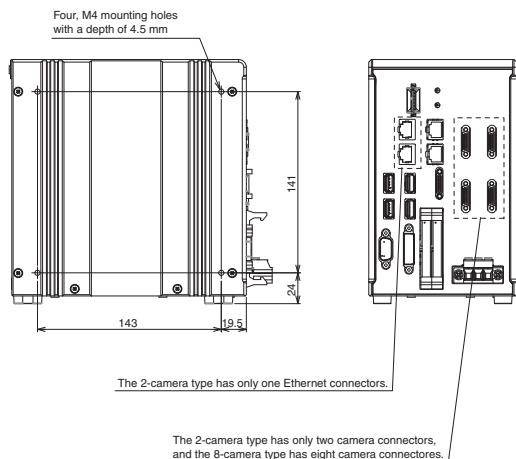

FH-Series

FZ5-series Lite Box-type

FZ5-L350/-L355/-L350-10/-L355-10

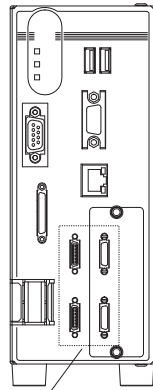

* The 2-camera type has only two camera connectors on its right side.

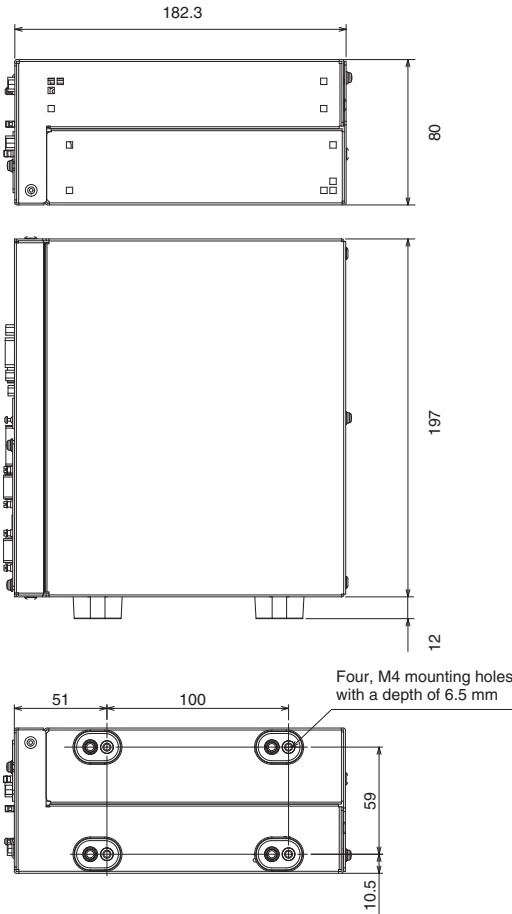

Cameras

High-speed CMOS Camera

300,000-pixel camera

FH-SC
FH-SM

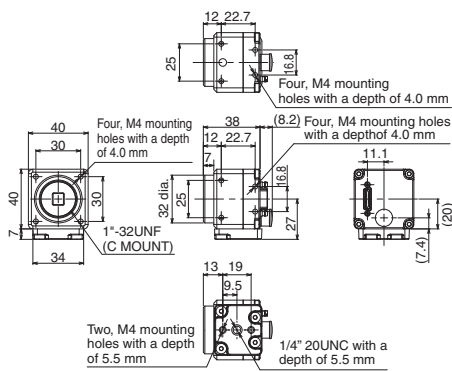

2 million-pixel camera

FH-SC02
FH-SM02

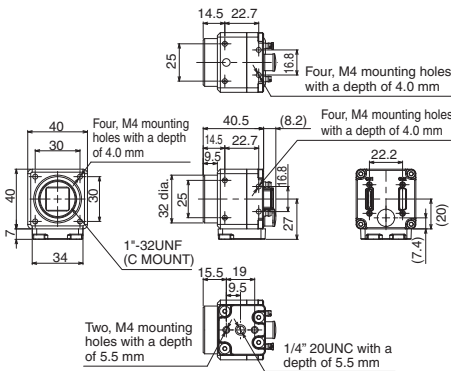

4 million-pixel camera

FH-SC04
FH-SM04

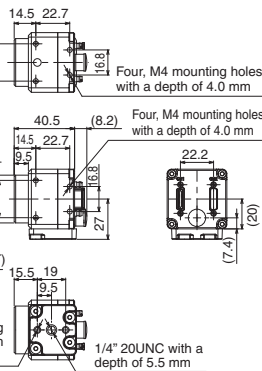

12 million-pixel camera

FH-SC12
FH-SM12

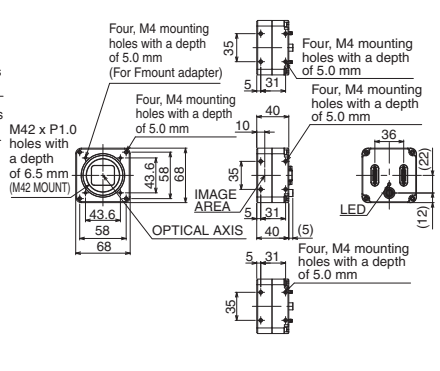

Digital CCD Cameras

300,000-pixel camera

FZ-S
FZ-SC

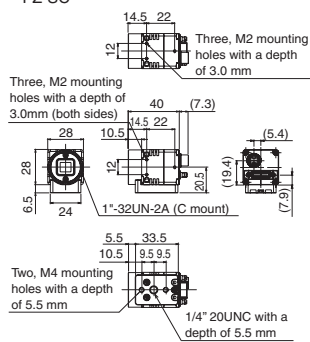

2 million-pixel camera

FZ-S2M
FZ-SC2M

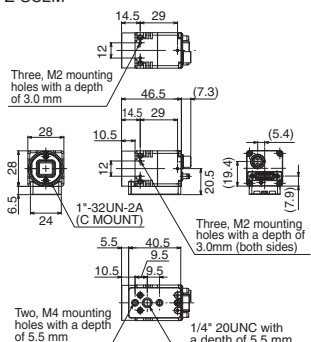

5 million-pixel camera

FZ-S5M2
FZ-SC5M2

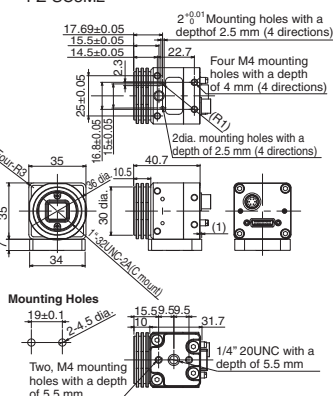

High-speed CCD Camera

FZ-SH
FZ-SHC

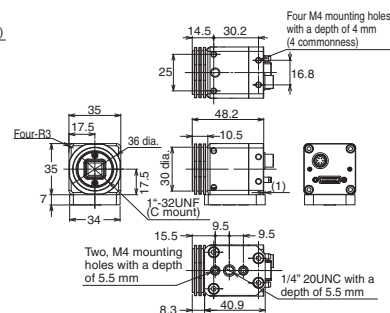

Small digital CCD cameras

Camera head

Flat camera
FZ-SF
FZ-SFC

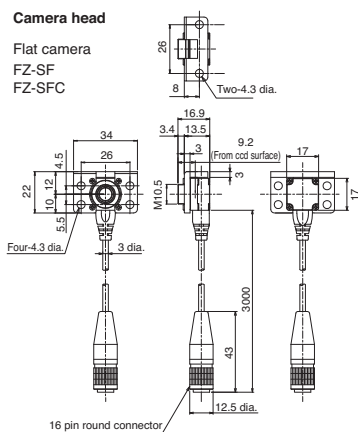

Pen-shaped camera

FZ-SP
FZ-SPC

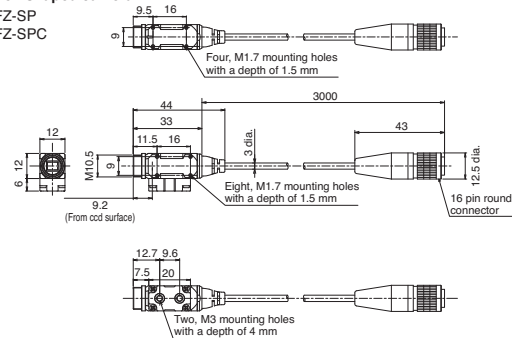

Camera amplifier

Can be used for both flat cameras and pen-shaped cameras

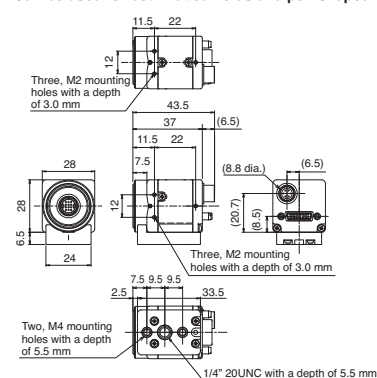

Intelligent Compact CMOS Cameras

Narrow view / Standard

FZ-SQ010F
FZ-SQ050F

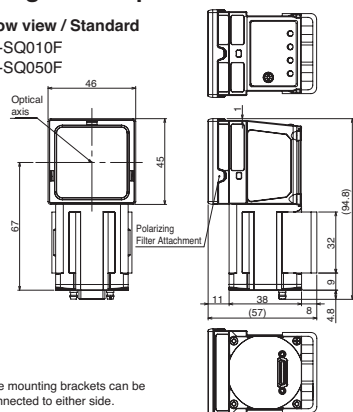

Wide View

FZ-SQ100F (long-distance)
FZ-SQ100N (short-distance)

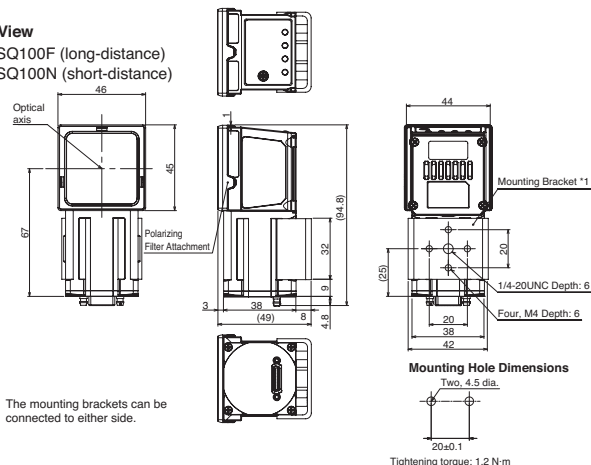

*1. The mounting brackets can be connected to either side.

*1. The mounting brackets can be connected to either side.

Cables

Camera Cable

Camera Cable

FZ-VS3

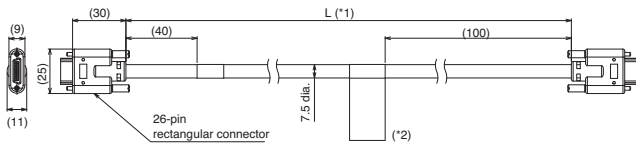

Bend resistant Camera Cable

FZ-VSB3

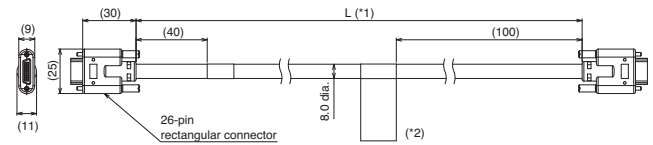

Right-angle Camera Cable

FZ-VSL3

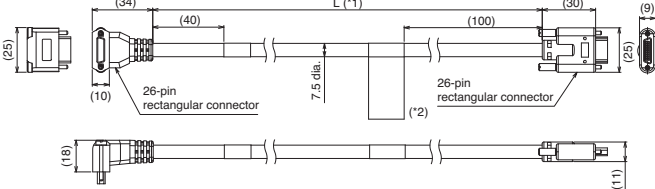

Bend resistant Right-angle Camera Cable

FZ-VSLB3

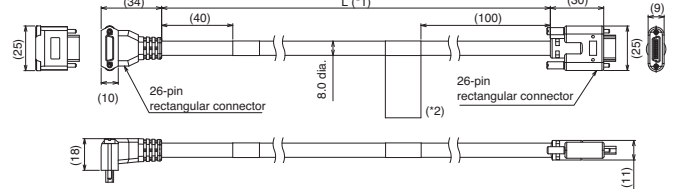

Long-distance Camera Cable

FZ-VS4

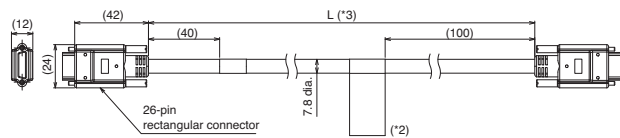

Long-distance Right-angle Camera Cable

FZ-VSL4

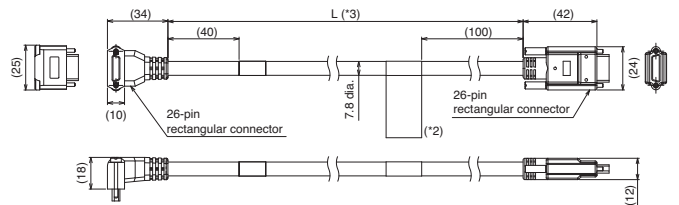

- *1. Cable is available in 2m/3m/5m/10m.
- *2. Each camera cables has polarity. Please ensure that the name plate side of the cable is connected to the controller.
- *3. Cable is available in 15m.

Camera Cable Extension Unit

FZ-VSJ

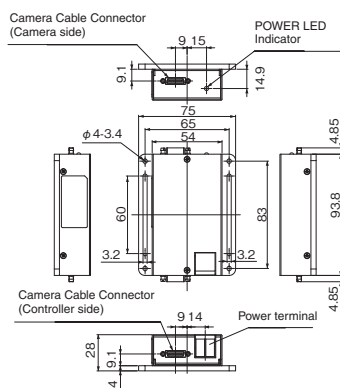

Extension Tubes for Small Camera

FZ-LESR

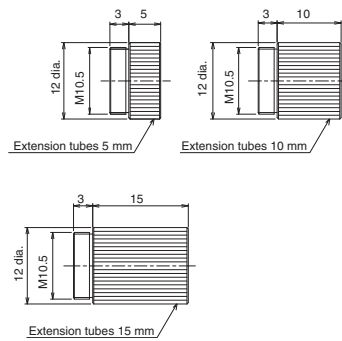

Lens for Small Camera

FZ-LES Series

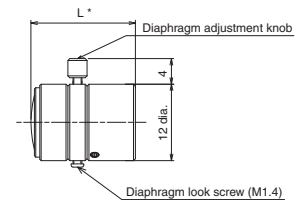

* Overall length is available in 16.4mm/19.7mm/23.1mm/25.5mm.

Encoder Cable

FH-VR

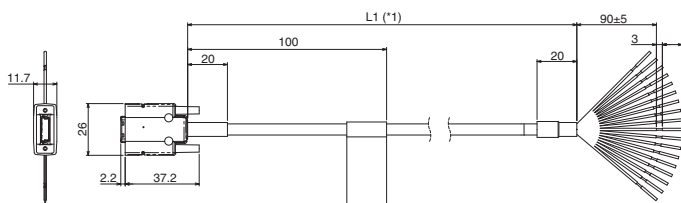

*1. Cable is available in 1.5 m.

Parallel I/O Cable

XW2Z-S013-□

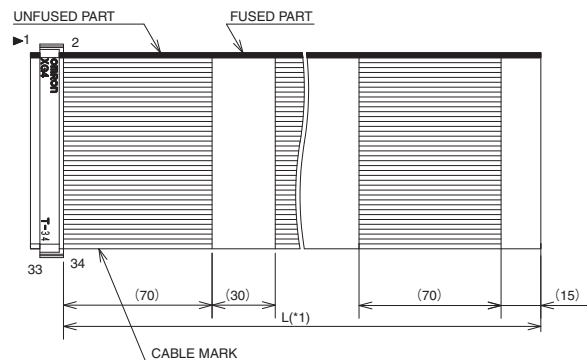

*1. Cable is available in 2m/5m.

Touch Panel Monitor

FH-MT12

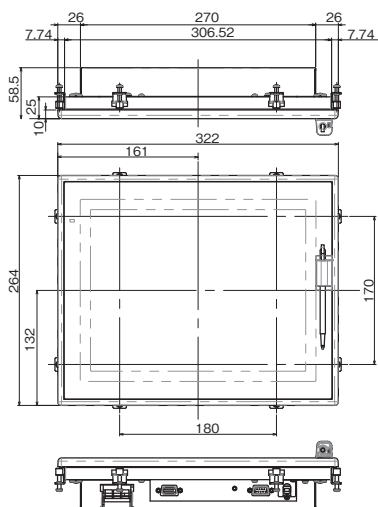

Panel cutout dimensions

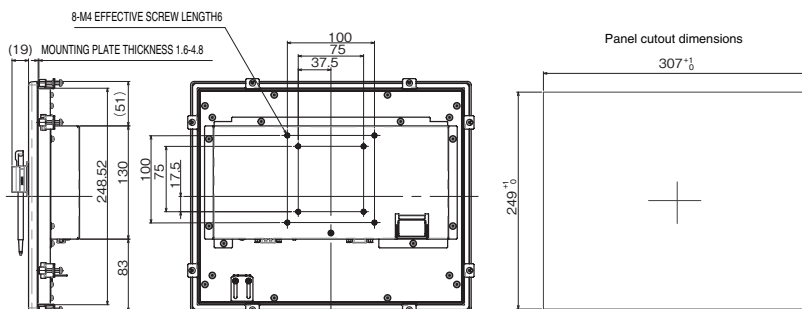

DVI-Analog Conversion Cable for Touch Panel Monitor

FH-VMDA

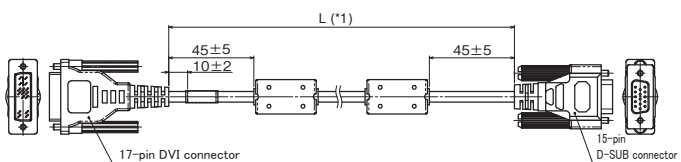

RS-232C Cable for Touch Panel Monitor

XW2Z-□□PP-1

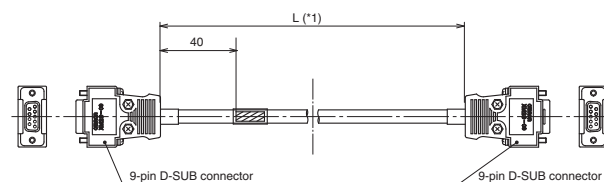

USB Cable for Touch Panel Monitor

FH-VUAB

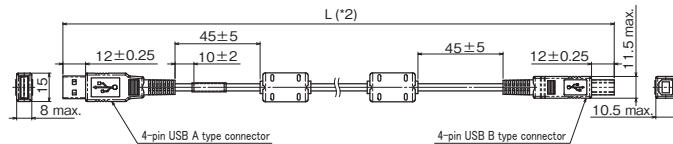

*1. Cable is available in 2m/5m/10m.
*2. Cable is available in 2m/5m.

LCD Monitor

FZ-M08

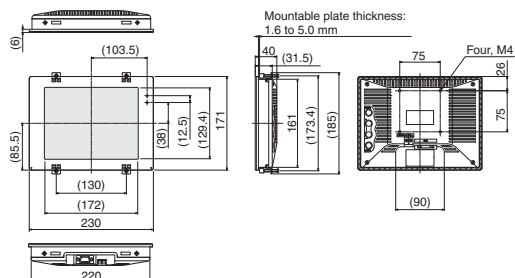

LED Monitor Cable

FZ-VM

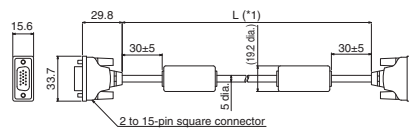

*1. cable is available in 2m/5m.

Meaning of Optical Chart

The X axis of the optical chart shows the field of vision (mm) (*1), and the Y axis of the optical chart shows the camera installation distance (mm) (*2).

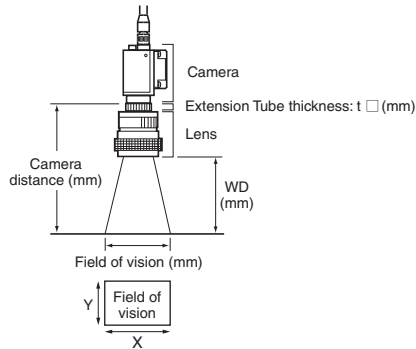

- *1. The lengths of the fields of vision given in the optical charts are the lengths of the Y axis.
- *2. The vertical axis represents WD for small cameras.

High-speed CMOS Camera FH-S□12, 12 million-pixel

3Z4S-LE

- VS-L10028/M42-10
- VS-L8540/M42-10
- VS-L5028/M42-10
- VS-L3528/M42-10
- VS-L2526/M42-10
- VS-L1828/M42-10

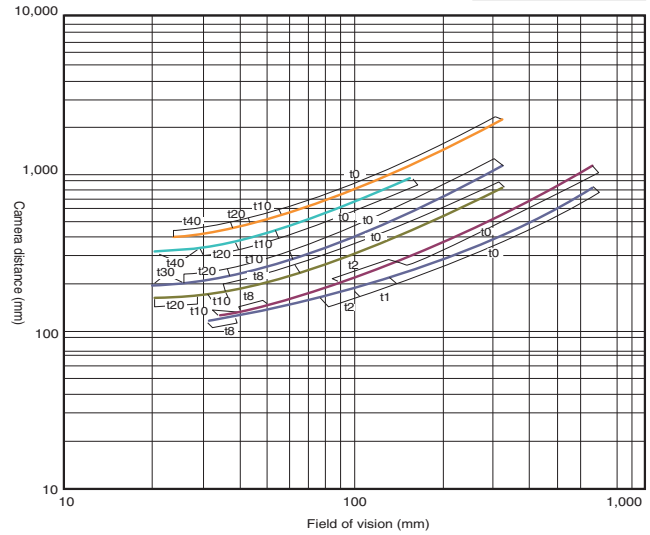

High-speed CMOS Camera FH-S□04, 4 million-pixel

3Z4S-LE

- SV-10028H
- SV-7525H
- VS-5018H1
- VS-3514H1
- VS-2514H1
- VS-1614H1N
- VS-1214H1
- VS-0814H1
- VS-0618H1

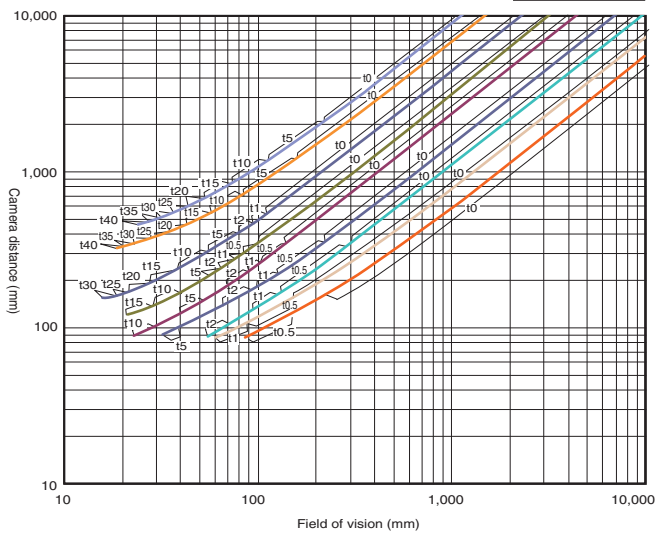

High-speed CMOS Camera FH-S□02, 2million-pixel

3Z4S-LE

- SV-10028H
- SV-7525H
- VS-5014H1
- VS-3514H1
- VS-2514H1
- VS-1614H1N
- VS-1214H1
- VS-0814H1
- VS-0618H1

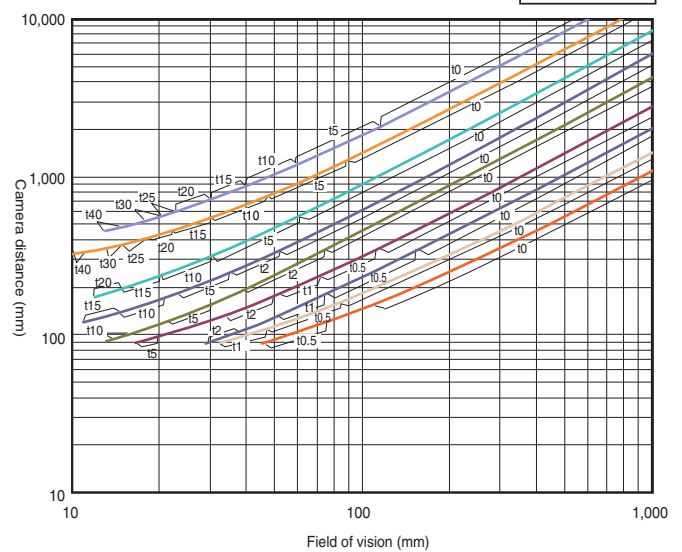

High-speed CMOS Camera
FH-S□,
High-speed CCD Camera
FZ-SH□,
Digital CCD Camera
FZ-S□,
300,000-pixel

3Z4S-LE

- SV-10035V
- SV-7527V
- SV-5018V
- SV-3518V
- SV-2514V
- SV-1614V
- SV-1214V
- SV-0813V
- SV-0614V
- SV-04514V
- SV-03514V

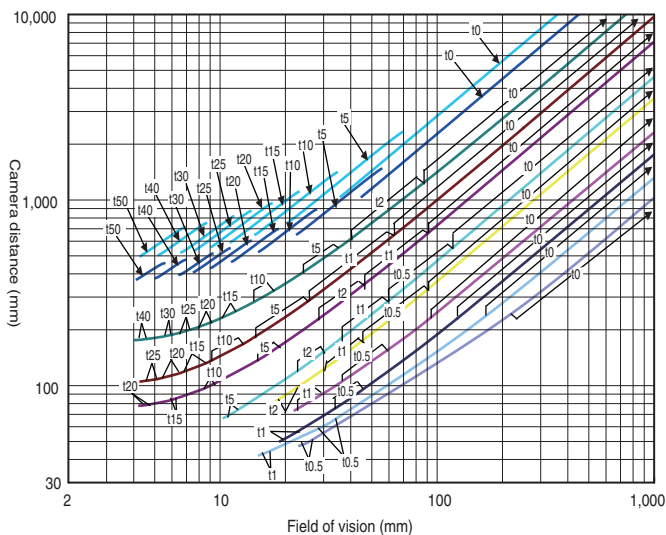

Digital CCD Camera
FZ-S□5M2,
5 million-pixel

3Z4S-LE

- SV-10028H
- SV-7525H
- SV-5014H
- SV-3514H
- SV-2514H
- SV-1614H
- SV-1214H
- SV-0814H
- SV-0614H

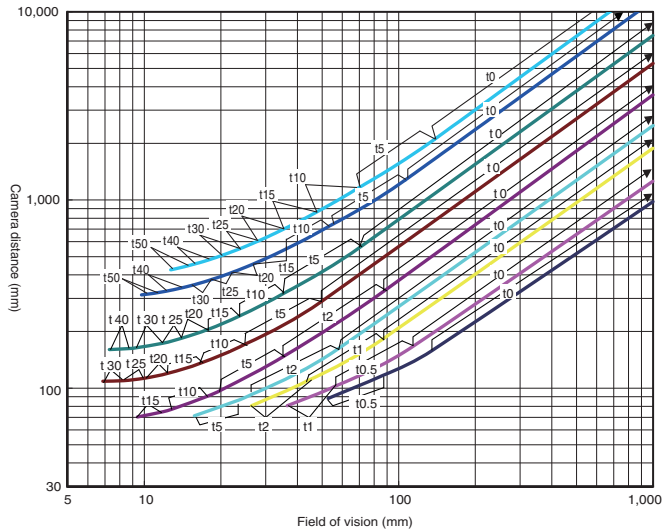

Digital CCD Camera
FZ-S□2M,
2 million-pixel

3Z4S-LE

- SV-10028H
- SV-7525H
- SV-5014H
- SV-3514H
- SV-2514H
- SV-1614H
- SV-1214H
- SV-0814H
- SV-0614H

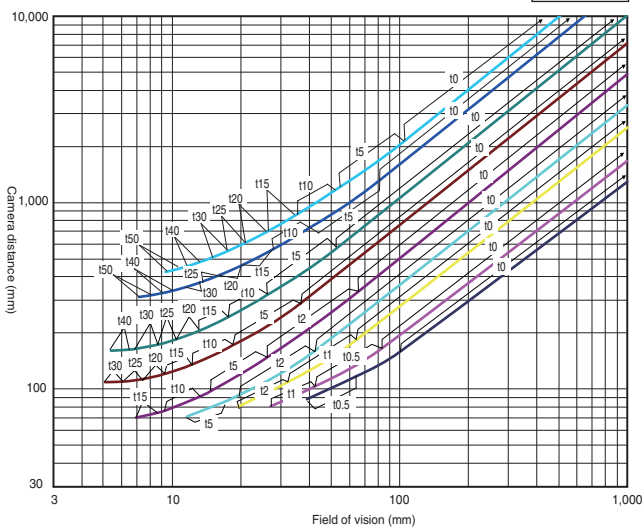

Small Digital CCD Cameras
FZ-SF□,
FZ-SP□,
300,000-pixel

- FZ-LES30
- FZ-LES16
- FZ-LES6
- FZ-LES3

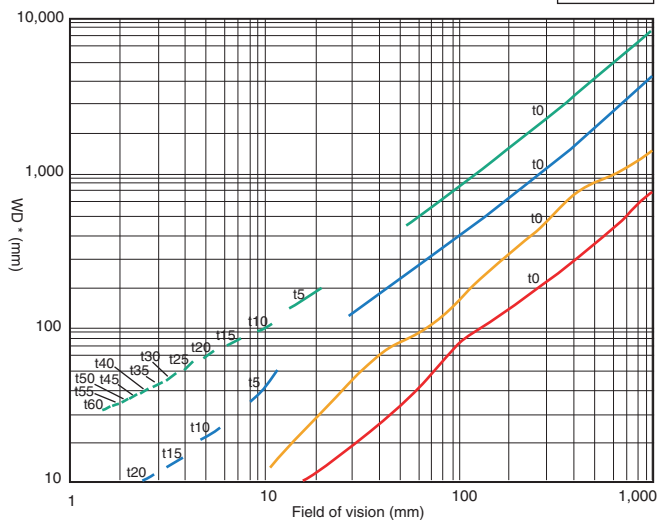

* The vertical axis represents WD, not installation distance.

High-speed CMOS Camera
 FH-S□,
 High-speed CCD Camera
 FZ-SH□,
 Digital CCD Camera
 FZ-S□,
 300,000-pixel
 (Vibrations and shocks resistant)

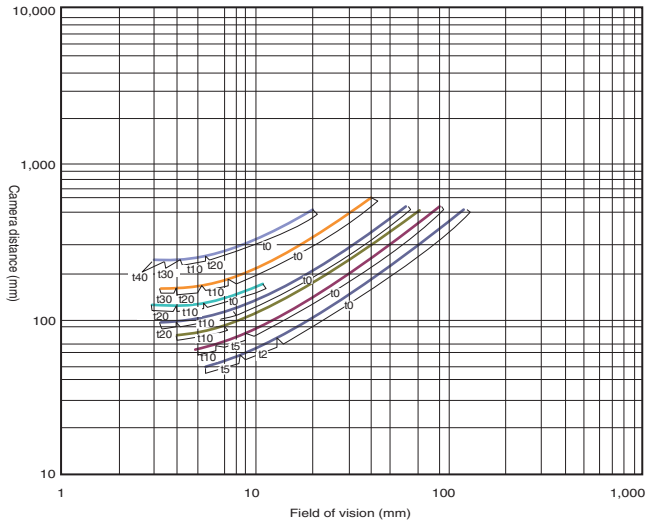
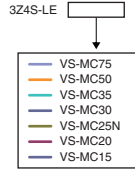

Digital CCD Camera
 FZ-S□5M2,
 5 million-pixel
 (Vibrations and shocks resistant)

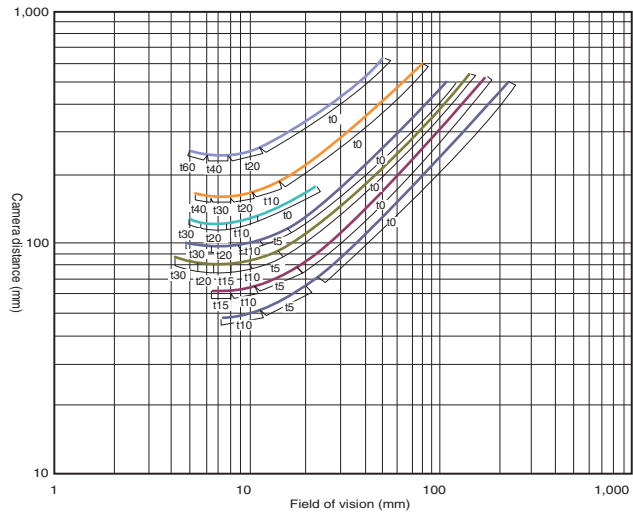
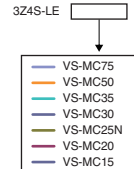

Digital CCD Camera
 FZ-S□2M,
 2 million-pixel
 (Vibrations and shocks resistant)

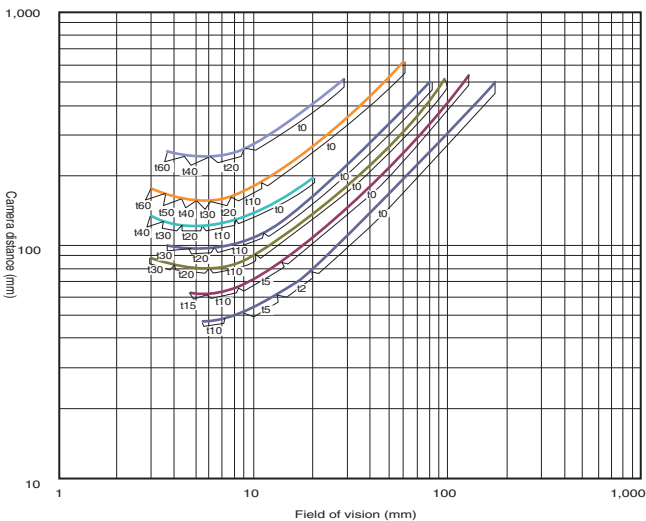
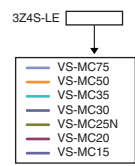

Related Manuals

Man.No.	Model number	Manual
Z340	FH/FZ5	Vision System FH/FZ5 Series User's Manual
Z341	FH/FZ5	Vision System FH/FZ5 Series Processing Item Function Reference Manual
Z342	FH/FZ5	Vision System FH/FZ5 Series User's Manual for Communications Settings
Z343	FH	Vision System FH Series Operation Manual for Sysmac Studio

Terms and Conditions Agreement

Read and understand this catalog.

Please read and understand this catalog before purchasing the products. Please consult your OMRON representative if you have any questions or comments.

Warranties.

- (a) Exclusive Warranty. Omron's exclusive warranty is that the Products will be free from defects in materials and workmanship for a period of twelve months from the date of sale by Omron (or such other period expressed in writing by Omron). Omron disclaims all other warranties, express or implied.
- (b) Limitations. OMRON MAKES NO WARRANTY OR REPRESENTATION, EXPRESS OR IMPLIED, ABOUT NON-INFRINGEMENT, MERCHANTABILITY OR FITNESS FOR A PARTICULAR PURPOSE OF THE PRODUCTS. BUYER ACKNOWLEDGES THAT IT ALONE HAS DETERMINED THAT THE PRODUCTS WILL SUITABLY MEET THE REQUIREMENTS OF THEIR INTENDED USE.

Omron further disclaims all warranties and responsibility of any type for claims or expenses based on infringement by the Products or otherwise of any intellectual property right. (c) Buyer Remedy. Omron's sole obligation hereunder shall be, at Omron's election, to (i) replace (in the form originally shipped with Buyer responsible for labor charges for removal or replacement thereof) the non-complying Product, (ii) repair the non-complying Product, or (iii) repay or credit Buyer an amount equal to the purchase price of the non-complying Product; provided that in no event shall Omron be responsible for warranty, repair, indemnity or any other claims or expenses regarding the Products unless Omron's analysis confirms that the Products were properly handled, stored, installed and maintained and not subject to contamination, abuse, misuse or inappropriate modification. Return of any Products by Buyer must be approved in writing by Omron before shipment. Omron Companies shall not be liable for the suitability or unsuitability or the results from the use of Products in combination with any electrical or electronic components, circuits, system assemblies or any other materials or substances or environments. Any advice, recommendations or information given orally or in writing, are not to be construed as an amendment or addition to the above warranty.

See <http://www.omron.com/global/> or contact your Omron representative for published information.

Limitation on Liability; Etc.

OMRON COMPANIES SHALL NOT BE LIABLE FOR SPECIAL, INDIRECT, INCIDENTAL, OR CONSEQUENTIAL DAMAGES, LOSS OF PROFITS OR PRODUCTION OR COMMERCIAL LOSS IN ANY WAY CONNECTED WITH THE PRODUCTS, WHETHER SUCH CLAIM IS BASED IN CONTRACT, WARRANTY, NEGLIGENCE OR STRICT LIABILITY.

Further, in no event shall liability of Omron Companies exceed the individual price of the Product on which liability is asserted.

Suitability of Use.

Omron Companies shall not be responsible for conformity with any standards, codes or regulations which apply to the combination of the Product in the Buyer's application or use of the Product. At Buyer's request, Omron will provide applicable third party certification documents identifying ratings and limitations of use which apply to the Product. This information by itself is not sufficient for a complete determination of the suitability of the Product in combination with the end product, machine, system, or other application or use. Buyer shall be solely responsible for determining appropriateness of the particular Product with respect to Buyer's application, product or system. Buyer shall take application responsibility in all cases.

NEVER USE THE PRODUCT FOR AN APPLICATION INVOLVING SERIOUS RISK TO LIFE OR PROPERTY OR IN LARGE QUANTITIES WITHOUT ENSURING THAT THE SYSTEM AS A WHOLE HAS BEEN DESIGNED TO ADDRESS THE RISKS, AND THAT THE OMRON PRODUCT(S) IS PROPERLY RATED AND INSTALLED FOR THE INTENDED USE WITHIN THE OVERALL EQUIPMENT OR SYSTEM.

Programmable Products.

Omron Companies shall not be responsible for the user's programming of a programmable Product, or any consequence thereof.

Performance Data.

Data presented in Omron Company websites, catalogs and other materials is provided as a guide for the user in determining suitability and does not constitute a warranty. It may represent the result of Omron's test conditions, and the user must correlate it to actual application requirements. Actual performance is subject to the Omron's Warranty and Limitations of Liability.

Change in Specifications.

Product specifications and accessories may be changed at any time based on improvements and other reasons. It is our practice to change part numbers when published ratings or features are changed, or when significant construction changes are made. However, some specifications of the Product may be changed without any notice. When in doubt, special part numbers may be assigned to fix or establish key specifications for your application. Please consult with your Omron's representative at any time to confirm actual specifications of purchased Product.

Errors and Omissions.

Information presented by Omron Companies has been checked and is believed to be accurate; however, no responsibility is assumed for clerical, typographical or proofreading errors or omissions.

Note: Do not use this document to operate the Unit.

OMRON Corporation Industrial Automation Company

Tokyo, JAPAN

Contact: www.ia.omron.com

Regional Headquarters

OMRON EUROPE B.V.

Sensor Business Unit

Carl-Benz-Str. 4, D-71154 Nufringen, Germany
Tel: (49) 7032-811-0/Fax: (49) 7032-811-199

OMRON ELECTRONICS LLC

2895 Greenspoint Parkway, Suite 200
Hoffman Estates, IL 60169 U.S.A
Tel: (1) 847-843-7900/Fax: (1) 847-843-7787

OMRON ASIA PACIFIC PTE. LTD.

No. 438A Alexandra Road # 05-05/08 (Lobby 2),
Alexandra Technopark,
Singapore 119967
Tel: (65) 6835-3011/Fax: (65) 6835-2711

OMRON (CHINA) CO., LTD.

Room 2211, Bank of China Tower,
200 Yin Cheng Zhong Road,
PuDong New Area, Shanghai, 200120, China
Tel: (86) 21-5037-2222/Fax: (86) 21-5037-2200

Authorized Distributor:

© OMRON Corporation 2013-2015 All Rights Reserved.
In the interest of product improvement,
specifications are subject to change without notice.
CSM_10_1_0115

Cat. No. Q197-E1-04

0115(0613)

Mouser Electronics

Authorized Distributor

Click to View Pricing, Inventory, Delivery & Lifecycle Information:

Omron:

[XW2Z-S013-5](#) [XW2Z-S013-2](#)

Компания «Океан Электроники» предлагает заключение долгосрочных отношений при поставках импортных электронных компонентов на взаимовыгодных условиях!

Наши преимущества:

- Поставка оригинальных импортных электронных компонентов напрямую с производств Америки, Европы и Азии, а так же с крупнейших складов мира;
- Широкая линейка поставок активных и пассивных импортных электронных компонентов (более 30 млн. наименований);
- Поставка сложных, дефицитных, либо снятых с производства позиций;
- Оперативные сроки поставки под заказ (от 5 рабочих дней);
- Экспресс доставка в любую точку России;
- Помощь Конструкторского Отдела и консультации квалифицированных инженеров;
- Техническая поддержка проекта, помощь в подборе аналогов, поставка прототипов;
- Поставка электронных компонентов под контролем ВП;
- Система менеджмента качества сертифицирована по Международному стандарту ISO 9001;
- При необходимости вся продукция военного и аэрокосмического назначения проходит испытания и сертификацию в лаборатории (по согласованию с заказчиком);
- Поставка специализированных компонентов военного и аэрокосмического уровня качества (Xilinx, Altera, Analog Devices, Intersil, Interpoint, Microsemi, Actel, Aeroflex, Peregrine, VPT, Syfer, Eurofarad, Texas Instruments, MS Kennedy, Miteq, Cobham, E2V, MA-COM, Hittite, Mini-Circuits, General Dynamics и др.);

Компания «Океан Электроники» является официальным дистрибьютором и эксклюзивным представителем в России одного из крупнейших производителей разъемов военного и аэрокосмического назначения «**JONHON**», а так же официальным дистрибьютором и эксклюзивным представителем в России производителя высокотехнологичных и надежных решений для передачи СВЧ сигналов «**FORSTAR**».



JONHON

«**JONHON**» (основан в 1970 г.)

Разъемы специального, военного и аэрокосмического назначения:

(Применяются в военной, авиационной, аэрокосмической, морской, железнодорожной, горно- и нефтедобывающей отраслях промышленности)

«**FORSTAR**» (основан в 1998 г.)

ВЧ соединители, коаксиальные кабели, кабельные сборки и микроволновые компоненты:

(Применяются в телекоммуникациях гражданского и специального назначения, в средствах связи, РЛС, а так же военной, авиационной и аэрокосмической отраслях промышленности).



Телефон: 8 (812) 309-75-97 (многоканальный)

Факс: 8 (812) 320-03-32

Электронная почта: ocean@oceanchips.ru

Web: <http://oceanchips.ru/>

Адрес: 198099, г. Санкт-Петербург, ул. Калинина, д. 2, корп. 4, лит. А