

Infrared Emitter Arrays (940 nm)

Version 1.2

**SFH 4942/ 4943/ 4944/ 4945/ 4946/ 4947/ 4948/ 4949/
4940**

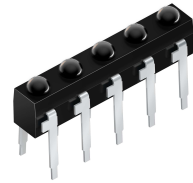

Features:

- Wavelength 950nm
- Leadframe arrays, available from 2 to 10 Emitters per array
- Short switching times
- Same package dimensions as BPX 80 series
- Miniature package

Applications

- Miniature photointerrupters
- Barcode reader
- Industrial electronics
- For control and drive circuits
- Sensor technology
- Speed controller

Notes

Depending on the mode of operation, these devices emit highly concentrated non visible infrared light which can be hazardous to the human eye. Products which incorporate these devices have to follow the safety precautions given in IEC 60825-1 and IEC 62471.

Ordering Information

Type:	Radiant Intensity I_e [mW/sr] $I_F = 40 \text{ mA}, t_p = 20 \text{ ms}$	Ordering Code
SFH 4942	50 (≥ 16)	Q65111A6679
SFH 4943	50 (≥ 16)	Q65111A6680
SFH 4944	50 (≥ 16)	Q65111A6681
SFH 4945	50 (≥ 16)	Q65111A6682
SFH 4946	50 (≥ 16)	Q65111A6683
SFH 4947	50 (≥ 16)	Q65111A6684
SFH 4948	50 (≥ 16)	Q65111A6685
SFH 4949	50 (≥ 16)	Q65111A6686
SFH 4940	50 (≥ 16)	Q65111A6687

Note: measured at a solid angle of $\Omega = 0.001 \text{ sr}$

Maximum Ratings ($T_A = 25\text{ °C}$)

Parameter	Symbol	Values	Unit
Operation and storage temperature range	$T_{op}; T_{stg}$	-40 ... 80	°C
Reverse voltage	V_R	5	V
Forward current	I_F	40	mA
Surge current ($t_p \leq 40\ \mu\text{s}$, $D = 0$)	I_{FSM}	1	A
Power consumption	P_{tot}	70	mW
ESD withstand voltage (acc. to ANSI/ ESDA/ JEDEC JS-001 - HBM)	V_{ESD}	2	kV
Thermal resistance junction - ambient ^{1) page 9}	R_{thJA}	750	K / W
Thermal resistance junction - soldering point	R_{thJS}	650	K / W

Characteristics ($T_A = 25\text{ °C}$)

Parameter	Symbol	Values	Unit
Peak wavelength ($I_F = 40\text{ mA}$, $t_p = 20\text{ ms}$)	λ_{peak}	950	nm
Centroid wavelength ($I_F = 40\text{ mA}$, $t_p = 20\text{ ms}$)	$\lambda_{centroid}$	940	nm
Spectral bandwidth at 50% of I_{max} ($I_F = 40\text{ mA}$, $t_p = 20\text{ ms}$)	$\Delta\lambda$	42	nm
Half angle	φ	± 10	°
Dimensions of active chip area	L x W	0.3 x 0.3	mm x mm
Distance chip surface to lens top	H	1.3 ... 1.9	mm
Rise and fall time of I_e (10% and 90% of $I_{e\ max}$) ($I_F = 40\text{ mA}$, $R_L = 50\ \Omega$)	t_r, t_f	12	ns
Forward voltage ($I_F = 40\text{ mA}$, $t_p = 20\text{ ms}$)	V_F	1.35 (≤ 1.7)	V
Forward voltage ($I_F = 1\text{ A}$, $t_p = 100\ \mu\text{s}$)	V_F	3.6 (≤ 4.6)	V
Reverse current ($V_R = 5\text{ V}$)	I_R	not designed for reverse operation	μA
Total radiant flux ($I_F=40\text{ mA}$, $t_p=20\text{ ms}$)	Φ_e	30	mW

Parameter		Symbol	Values	Unit
Temperature coefficient of I_e or Φ_e ($I_F = 40$ mA, $t_p = 20$ ms)	(typ)	TC_I	-0.3	% / K
Temperature coefficient of V_F ($I_F = 40$ mA, $t_p = 20$ ms)	(typ)	TC_V	-0.8	mV / K
Temperature coefficient of wavelength ($I_F = 40$ mA, $t_p = 20$ ms)	(typ)	TC_λ	0.3	nm / K

Grouping ($T_A = 25$ °C)

Group	Min Radiant Intensity $I_F = 40$ mA, $t_p = 20$ ms $I_{e, \min}$ [mW / sr]	Max Radiant Intensity $I_F = 40$ mA, $t_p = 20$ ms $I_{e, \max}$ [mW / sr]	Typ Radiant Intensity $I_F = 1$ A, $t_p = 40$ μ s $I_{e, \text{typ}}$ [mW / sr]
SFH 4942/3/4/5/6/7/8/9/0	16	125	520

Note: measured at a solid angle of $\Omega = 0.01$ sr

Relative Spectral Emission ^{2) page 9}

$$I_{\text{rel}} = f(\lambda), T_A = 25^\circ\text{C}$$

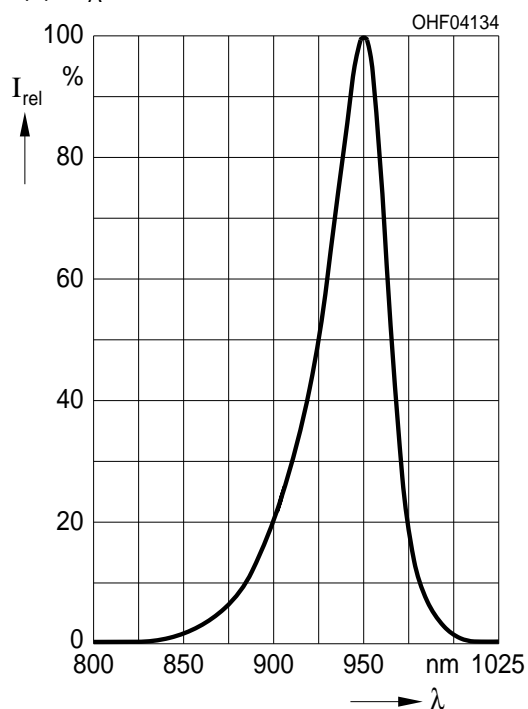

Radiant Intensity ^{2) page 9}

$$I_e / I_e(40 \text{ mA}) = f(I_F), \text{ single pulse, } t_p = 40 \mu\text{s}, T_A = 25^\circ\text{C}$$

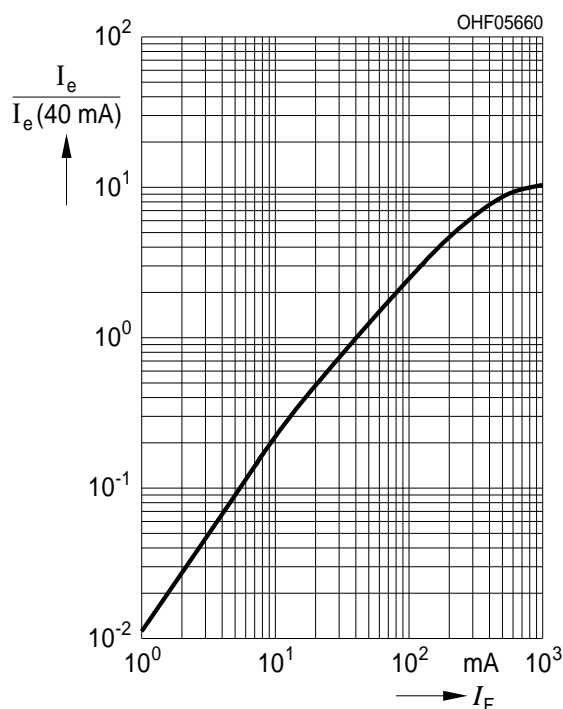

Max. Permissible Forward Current

$I_{F, \max} = f(T_A), R_{thJA} = 750 \text{ K / W}$

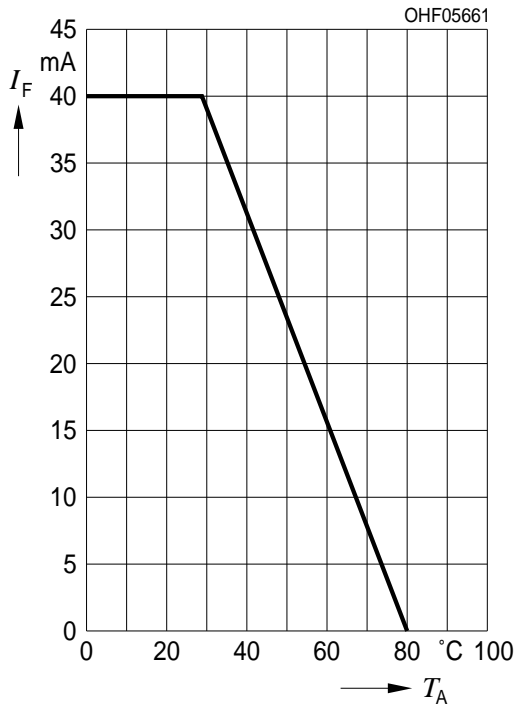

Forward Current ^{2) page 9}

$I_F = f(V_F), \text{ single pulse, } t_p = 40 \mu\text{s}, T_A = 25^\circ\text{C}$

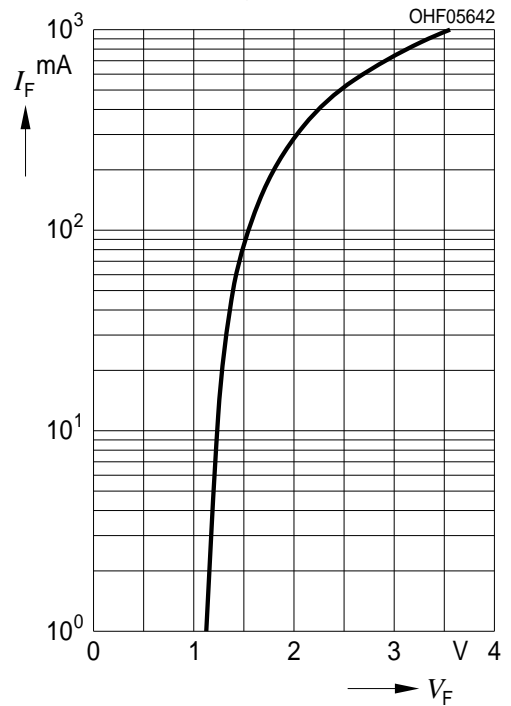

Permissible Pulse Handling Capability

$I_F = f(t_p), T_C = 25^\circ\text{C}, \text{ duty cycle } D = \text{parameter}$

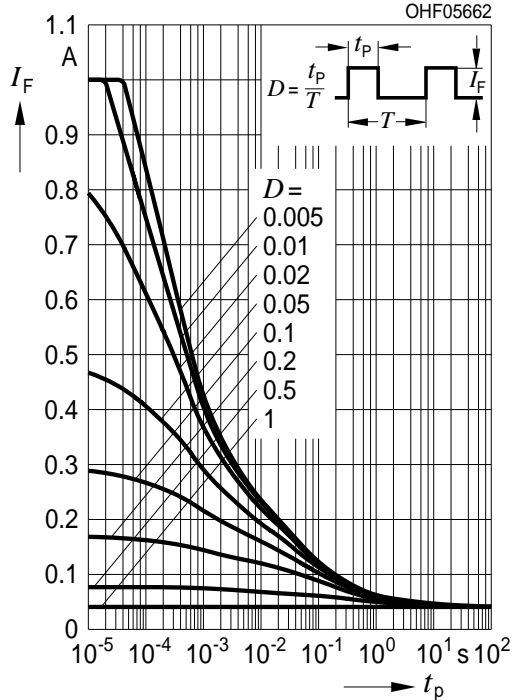

Radiation Characteristics 2) page 9

$I_{rel} = f(\phi), T_A = 25^\circ C$

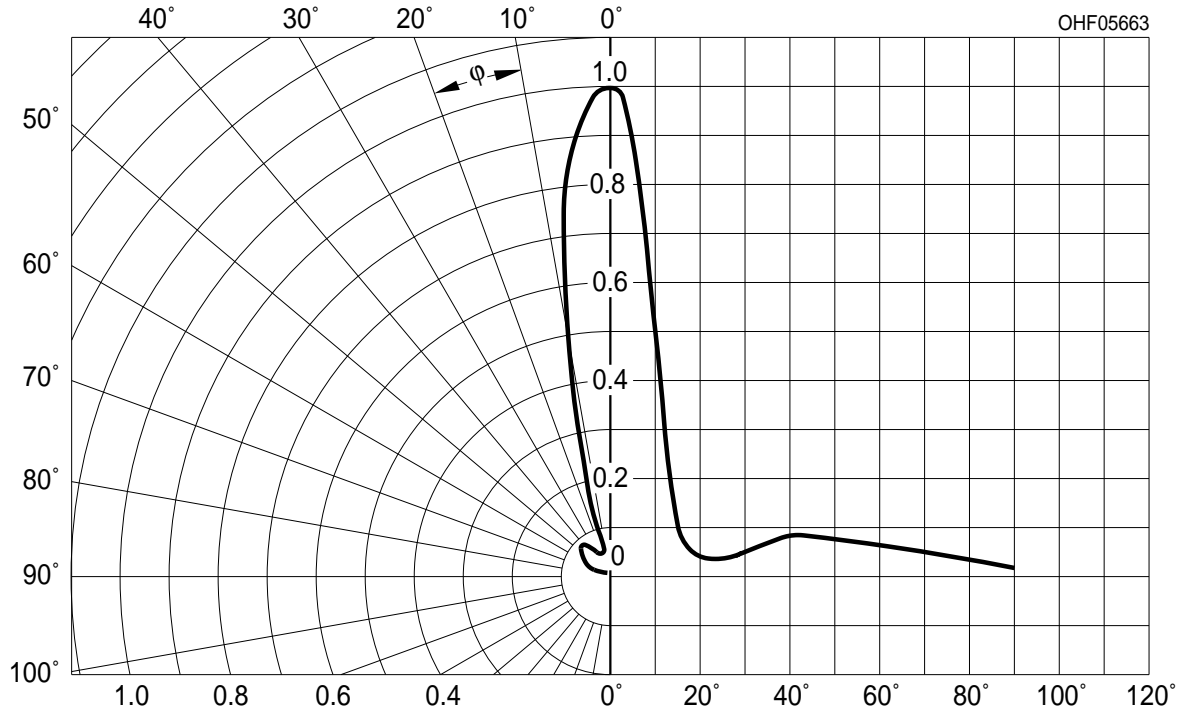

Package Outline

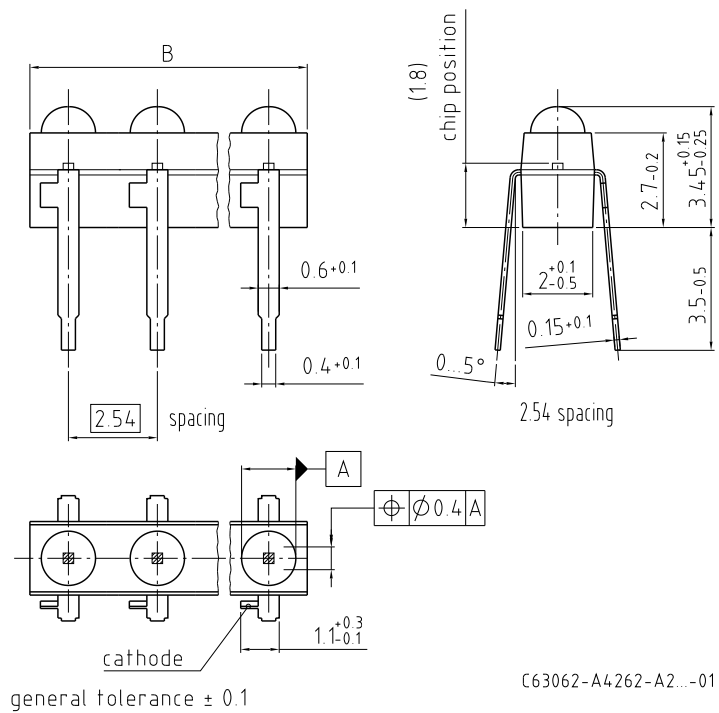

Dimensions in mm.

Type:	IREL per Row	Dimension "B"
SFH 4942	2	4.5 ... 4.9
SFH 4943	3	7.0 ... 7.4
SFH 4944	4	9.6 ... 10.0
SFH 4945	5	12.1 ... 12.5
SFH 4946	6	14.6 ... 16.0
SFH 4947	7	17.2 ... 17.6
SFH 4948	8	19.7 ... 20.1
SFH 4949	9	22.3 ... 22.7
SFH 4940	10	24.8 ... 25.2

Package

Miniature Array, Epoxy

Approximate Weight:

0.2 g

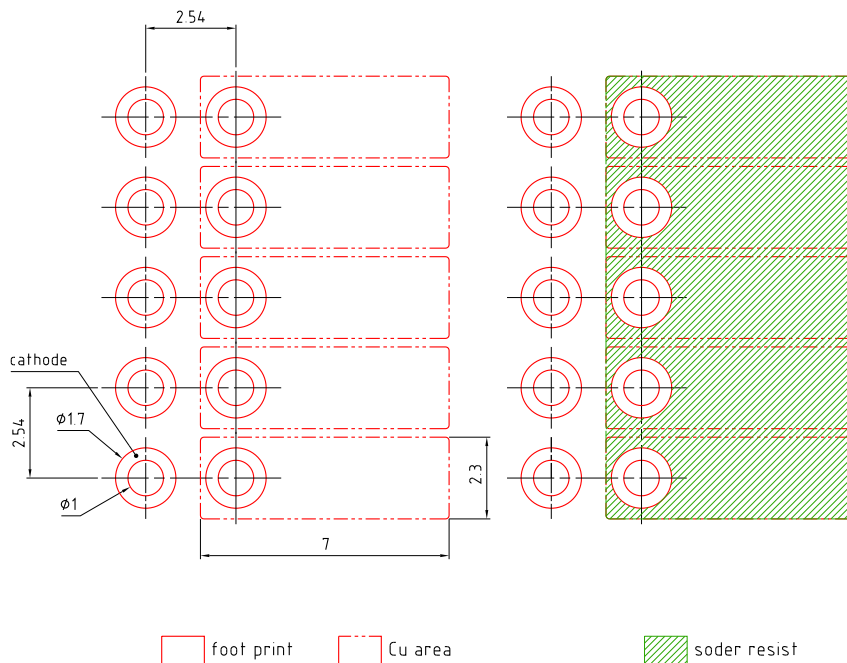
Recommended Solder Pad

E062 3010.190-01

Dimensions in mm.

TTW Soldering

IEC-61760-1 TTW

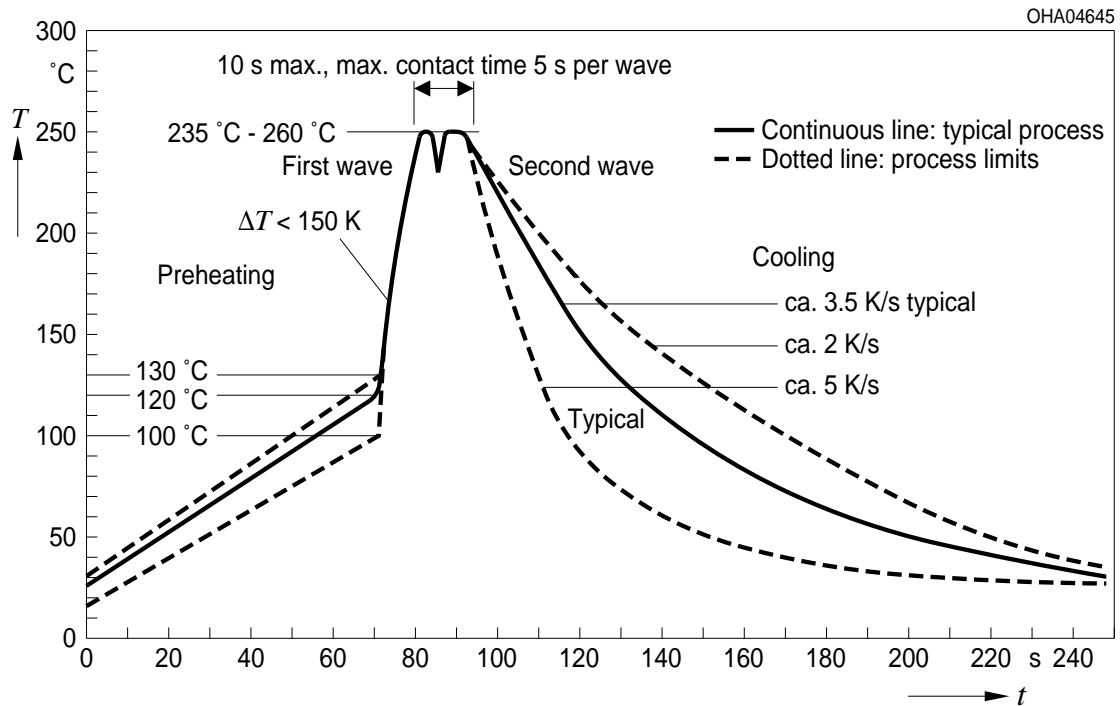
**Disclaimer**

Language english will prevail in case of any discrepancies or deviations between the two language wordings.

Attention please!

The information describes the type of component and shall not be considered as assured characteristics.

Terms of delivery and rights to change design reserved. Due to technical requirements components may contain dangerous substances.

For information on the types in question please contact our Sales Organization.

If printed or downloaded, please find the latest version in the Internet.

Packing

Please use the recycling operators known to you. We can also help you – get in touch with your nearest sales office. By agreement we will take packing material back, if it is sorted. You must bear the costs of transport. For packing material that is returned to us unsorted or which we are not obliged to accept, we shall have to invoice you for any costs incurred.

Components used in life-support devices or systems must be expressly authorized for such purpose!

Critical components* may only be used in life-support devices** or systems with the express written approval of OSRAM OS.

*) A critical component is a component used in a life-support device or system whose failure can reasonably be expected to cause the failure of that life-support device or system, or to affect its safety or the effectiveness of that device or system.

**) Life support devices or systems are intended (a) to be implanted in the human body, or (b) to support and/or maintain and sustain human life. If they fail, it is reasonable to assume that the health and the life of the user may be endangered.

Glossary

- 1) **Thermal resistance:** junction -ambient, mounted on PC-board (FR4), pads size 16 mm² each
- 2) **Typical Values:** Due to the special conditions of the manufacturing processes of LED, the typical data or calculated correlations of technical parameters can only reflect statistical figures. These do not necessarily correspond to the actual parameters of each single product, which could differ from the typical data and calculated correlations or the typical characteristic line. If requested, e.g. because of technical improvements, these typ. data will be changed without any further notice.

Published by OSRAM Opto Semiconductors GmbH
Leibnizstraße 4, D-93055 Regensburg
www.osram-os.com © All Rights Reserved.

EU RoHS and China RoHS compliant product



此产品符合欧盟 RoHS 指令的要求；
按照中国的相关法规和标准，不含有毒有害物质或元素。

Компания «Океан Электроники» предлагает заключение долгосрочных отношений при поставках импортных электронных компонентов на взаимовыгодных условиях!

Наши преимущества:

- Поставка оригинальных импортных электронных компонентов напрямую с производств Америки, Европы и Азии, а так же с крупнейших складов мира;
- Широкая линейка поставок активных и пассивных импортных электронных компонентов (более 30 млн. наименований);
- Поставка сложных, дефицитных, либо снятых с производства позиций;
- Оперативные сроки поставки под заказ (от 5 рабочих дней);
- Экспресс доставка в любую точку России;
- Помощь Конструкторского Отдела и консультации квалифицированных инженеров;
- Техническая поддержка проекта, помощь в подборе аналогов, поставка прототипов;
- Поставка электронных компонентов под контролем ВП;
- Система менеджмента качества сертифицирована по Международному стандарту ISO 9001;
- При необходимости вся продукция военного и аэрокосмического назначения проходит испытания и сертификацию в лаборатории (по согласованию с заказчиком);
- Поставка специализированных компонентов военного и аэрокосмического уровня качества (Xilinx, Altera, Analog Devices, Intersil, Interpoint, Microsemi, Actel, Aeroflex, Peregrine, VPT, Syfer, Eurofarad, Texas Instruments, MS Kennedy, Miteq, Cobham, E2V, MA-COM, Hittite, Mini-Circuits, General Dynamics и др.);

Компания «Океан Электроники» является официальным дистрибьютором и эксклюзивным представителем в России одного из крупнейших производителей разъемов военного и аэрокосмического назначения «JONHON», а так же официальным дистрибьютором и эксклюзивным представителем в России производителя высокотехнологичных и надежных решений для передачи СВЧ сигналов «FORSTAR».



JONHON

«JONHON» (основан в 1970 г.)

Разъемы специального, военного и аэрокосмического назначения:

(Применяются в военной, авиационной, аэрокосмической, морской, железнодорожной, горно- и нефтедобывающей отраслях промышленности)

«FORSTAR» (основан в 1998 г.)

ВЧ соединители, коаксиальные кабели,
кабельные сборки и микроволновые компоненты:

(Применяются в телекоммуникациях гражданского и специального назначения, в средствах связи, РЛС, а так же военной, авиационной и аэрокосмической отраслях промышленности).



Телефон: 8 (812) 309-75-97 (многоканальный)

Факс: 8 (812) 320-03-32

Электронная почта: ocean@oceanchips.ru

Web: <http://oceanchips.ru/>

Адрес: 198099, г. Санкт-Петербург, ул. Калинина, д. 2, корп. 4, лит. А