

MAX31911

Industrial, Octal, Digital Input Translator/Serializer

General Description

The MAX31911 industrial interface serializer translates, conditions, and serializes the 24V digital output of sensors and switches used in industrial, process, and building automation to 5V CMOS-compatible signals required by microcontrollers. It provides the front-end interface circuit of a programmable logic controller (PLC) digital input module. The device features integrated current limiting, lowpass filtering, and channel serialization. Input current limiting allows a significant reduction in power consumed from the field voltage supply as compared to traditional discrete resistor-divider implementations. Selectable on-chip lowpass filters allow flexible debouncing and filtering of sensor outputs based on the application. On-chip serialization allows a drastic reduction in the number of optocouplers used for isolation. The device serializer is stackable so that any number of input channels can be serialized and output through only one SPI-compatible port. This reduces the number of optocouplers needed to only three, regardless of the number of input channels. For enhanced robustness with respect to high-frequency noise and fast electrical transients, a multibit CRC code is generated and transmitted through the SPI port for each 8 bits of data. The on-chip 5V voltage regulator can be used to power external optocouplers, digital isolators, or other external 5V circuitry.

For ultra-low-power applications, Maxim Integrated offers a pin-compatible version of this device, the MAX31910. The MAX31910 uses patent-pending circuit techniques to achieve further reduction of power beyond what is possible by input current limiting alone.

The future generation version of the MAX31910 and MAX31911 will include energy-less LED drivers while maintaining pin compatibility.

Ordering Information appears at end of data sheet.

Features

- ◆ Eight High-Voltage Input Channels (36V max)
- ◆ Configurable for IEC 61131-2 Input Types 1, 2, 3
- ◆ Wide Operating Supply Range of 7V to 36V
- ◆ Optional Configuration Allows 5V Supply
- ◆ Selectable Input Filtering and Debouncing from 0ms to 3ms
- ◆ Configurable Input Current Limiting from 0.5mA to 6mA
- ◆ High HBM ESD Immunity on All Field Input Pins
- ◆ On-Chip 8-to-1 Serialization with SPI Interface
- ◆ On-Chip 5V Regulator
- ◆ Overtemperature Indicator
- ◆ On-Chip 24V Field Supply Voltage Monitor
- ◆ Low Quiescent Current and Power Dissipation
- ◆ Multibit CRC Code Generation and Transmission for Error Detection and More Reliable Data Transmission to an External Micro

Applications

Digital Input Modules for PLCs
 Industrial, Building, and Process Automation
 Motor Control

Block Diagram

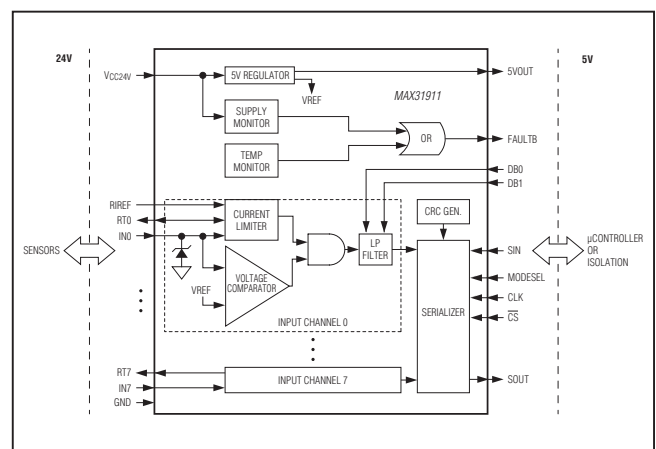

For related parts and recommended products to use with this part, refer to www.maximintegrated.com/MAX31911.related.

For pricing, delivery, and ordering information, please contact Maxim Direct at 1-888-629-4642, or visit Maxim Integrated's website at www.maximintegrated.com.

MAX31911

Industrial, Octal, Digital Input Translator/Serializer

ABSOLUTE MAXIMUM RATINGS

(Voltages relative to GND.)

Voltage Range on V_{CC24V}	-0.3V to +45V
Voltage Range on IN1–IN8	-0.3V to +45V
Voltage Range on IN1–IN8 (through 2.2k Ω resistors).....	-45V to +45V
Voltage Range on DB0/DB1, CLK, SIN, \overline{CS} , MODESEL	-0.3V to ($V_{DD} + 0.3V$)
Continuous Power Dissipation ($T_A = +70^\circ\text{C}$) TSSOP (derate 27mW/ $^\circ\text{C}$ above $+70^\circ\text{C}$).....	2162.2mW

Operating Temperature Range

Ambient Temperature.....	-40 $^\circ\text{C}$ to +125 $^\circ\text{C}$
Junction Temperature.....	-40 $^\circ\text{C}$ to +150 $^\circ\text{C}$
Storage Temperature Range.....	-55 $^\circ\text{C}$ to +125 $^\circ\text{C}$
Lead Temperature (soldering, 10s)	+300 $^\circ\text{C}$
Soldering Temperature (reflow)	+260 $^\circ\text{C}$

Stresses beyond those listed under "Absolute Maximum Ratings" may cause permanent damage to the device. These are stress ratings only, and functional operation of the device at these or any other conditions beyond those indicated in the operational sections of the specifications is not implied. Exposure to absolute maximum rating conditions for extended periods may affect device reliability.

PACKAGE THERMAL CHARACTERISTICS (Note 1)

TSSOP

Junction-to-Ambient Thermal Resistance (θ_{JA})	37 $^\circ\text{C}/\text{W}$
Junction-to-Case Thermal Resistance (θ_{JC})	2 $^\circ\text{C}/\text{W}$

Note 1: Package thermal resistances were obtained using the method described in JEDEC specification JESD51-7, using a four-layer board. For detailed information on package thermal considerations, refer to www.maximintegrated.com/thermal-tutorial.

RECOMMENDED OPERATING CONDITIONS (Note 2)

PARAMETER	SYMBOL	CONDITIONS	MIN	TYP	MAX	UNITS
Field Supply Voltage	V_{CC24V}		7		36	V
Field Inputs Voltage	V_{INn}	(Note 3)	-0.3		36	V
Logic Inputs Voltage	V_{LOGIC}		0		5.5	V
Current-Limit Setting Resistor	R_{REF}			15		k Ω
Field Input Data Rate	f_{IN}	(Note 4)		200		kHz

MAX31911

Industrial, Octal, Digital Input Translator/Serializer

DC ELECTRICAL CHARACTERISTICS

($V_{CC24V} = 7V$ to $36V$, $T_J = -40^{\circ}C$ to $+150^{\circ}C$, unless otherwise noted.) (Note 2)

PARAMETER	SYMBOL	CONDITIONS	MIN	TYP	MAX	UNITS
Field-Supply Current	I_{CC24V}	IN1–IN8 = 24V, 5VOUT = open, RT1–RT8 = GND, all logic inputs open		1.4	2.0	mA
Field-Supply UVLO Off/On	V_{ONUVLO}			9	10	V
Field-Supply UVLO On/Off	$V_{OFFUVLO}$		7	8		V
Field Input Threshold High-to-Low	$V_{IN-(INF)}$	2.2k Ω external series resistor	6	7.5		V
Field Input Threshold Low-to-High	$V_{IN+(INF)}$	2.2k Ω external series resistor		8.5	10	V
Field Input Hysteresis	$V_{HYS(INF)}$	2.2k Ω external series resistor		1		V
Input Threshold High-to-Low (at IC pin)	$V_{TH-(INP)}$		2	2.5		V
Input Threshold Low-to-High (at IC pin)	$V_{TH+(INP)}$			3.5	4	V
Input Threshold Hysteresis (at IC pin)	$V_{HYS(INP)}$			1		V
Field Input Pin Resistance	R_{INP}			0.8		k Ω
Field Input Current Limit	I_{INLIM}	$R_{REF} = 15k\Omega$, $V_{CC24V} = 18V$ to $30V$ (Note 5)	2.2	2.4	2.6	mA
Filter Time Constant	t_{FILTER}	DB1/DB0 = 0/0: no filtering		0		ms
		DB1/DB0 = 0/1	0.008	0.025	0.038	
		DB1/DB0 = 1/0	0.25	0.75	1.1	
		DB1/DB0 = 1/1	1.0	3	4.5	
Linear Regulator Output	V_{5VOUT}	Max $I_{LOAD} = 50mA$	4.75	5.0	5.25	V
Regulator Line Regulation	$dV_{REGLINE}$	$I_{LOAD} = 50mA$		10	20	mV
Regulator Load Regulation	$dV_{REGLOAD}$	$I_{LOAD} = 1mA$ to $50mA$		20	50	mV
Logic-Low Output Voltage	V_{OL}	$I_{OL} = 4mA$		0.4	1.0	V
Logic-High Output Voltage	V_{OH}	$I_{OH} = -4mA$	4.0			V
Logic-Input Trip Point	V_{IH-IL}		0.3x V_{5VOUT}	0.5x V_{5VOUT}	0.7x V_{5VOUT}	V
Logic-Input Leakage Current	I_{IL}		-50	-30	-15	μA
Overtemperature Alarm	T_{ALRM}			135		$^{\circ}C$

MAX31911

Industrial, Octal, Digital Input Translator/Serializer

AC ELECTRICAL CHARACTERISTICS

($V_{CC24V} = 7V$ to $36V$, $T_J = -40^{\circ}C$ to $+150^{\circ}C$, unless otherwise noted.) (Note 2)

PARAMETER	SYMBOL	CONDITIONS	MIN	TYP	MAX	UNITS
Field Input Pulse Width	t_{PW}	No external capacitors on pins IN1–IN8	1			μs
ESD		HBM, all pins		± 2		kV
		HBM, IN1–IN8 with respect to GND		± 15		

AC ELECTRICAL CHARACTERISTICS: SPI INTERFACE

($V_{CC24V} = 7V$ to $36V$, $T_J = -40^{\circ}C$ to $+150^{\circ}C$, unless otherwise noted.) (Note 2)

PARAMETER	SYMBOL	CONDITIONS	MIN	TYP	MAX	UNITS
CLK Pulse Duration	t_{CLKPW}	(Note 6)	20			ns
\overline{CS} Pulse Duration	t_{CSPW}	(Note 7)	20			ns
SIN to CLK Setup Time	t_{SU1}	(Note 8)	5			ns
SIN to CLK Hold Time	t_{H1}	(Note 8)	8			ns
\overline{CS} to CLK Setup Time	t_{SU2}	(Note 9)	8			ns
\overline{CS} to CLK Recovery Time	t_{REC}	(Note 9)	12			ns
Clock Pulse Frequency	f_{CLK}	(Notes 6, 10)	DC		25	MHz
Propagation Delay, CLK to SOUT	t_{P1}	(Note 6)			20	ns
Propagation Delay, \overline{CS} to SOUT	t_{P2}	(Note 7)			20	ns
Rise/Fall Time SOUT/ \overline{FAULT}	$t_{R/F}$	(Note 6)			40	ns

Note 2: Limits are 100% production tested at $T_A = +25^{\circ}C$ and/or $T_A = +125^{\circ}C$. Limits over the operating temperature range and relevant supply voltage range are guaranteed by design and characterization. Typical values are not guaranteed.

Note 3: When using suggested external $2.2k\Omega$ series resistors, limits of $-3V$ to $+36V$ apply.

Note 4: f_{IN} refers to the maximum pulse frequency ($1/f_{IN} =$ shortest pulse width) that can be detected from the field sensors and switches.

Note 5: External resistor R_{REF} can be adjusted to set any desired current limit between $0.5mA$ and $6mA$.

Note 6: See [Figure 8](#).

Note 7: See [Figure 5](#).

Note 8: See [Figure 7](#).

Note 9: See [Figure 6](#).

Note 10: This is the maximum bit transfer rate through the serializer interface.

MAX31911

Industrial, Octal, Digital Input Translator/Serializer

Typical Operating Characteristics

($T_A = +25^\circ\text{C}$, $R_{REF} = 15\text{k}\Omega$, unless otherwise noted.)

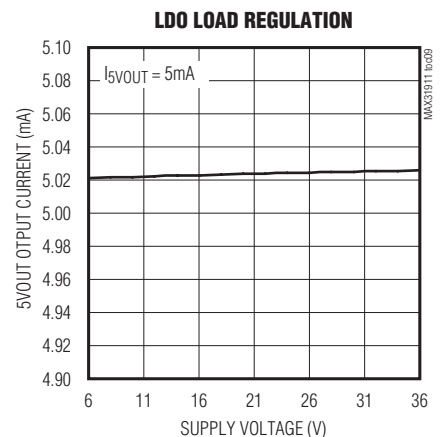
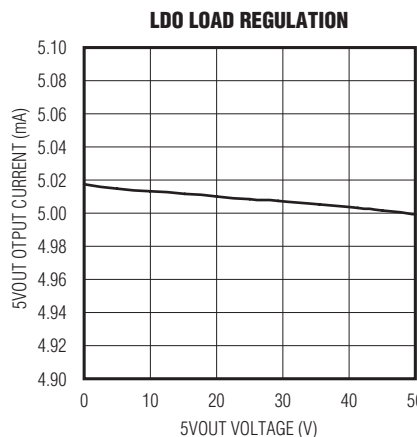
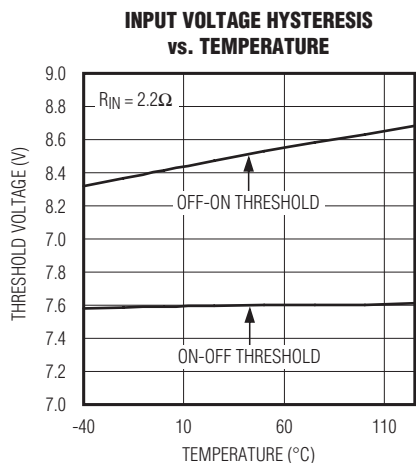
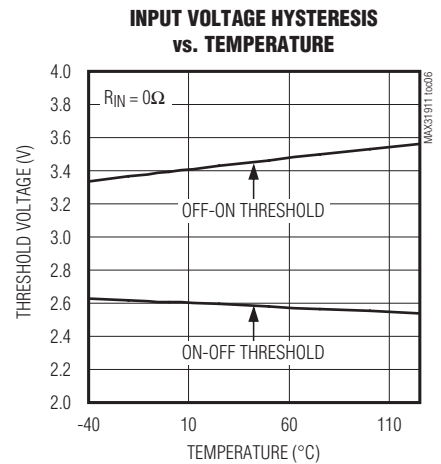
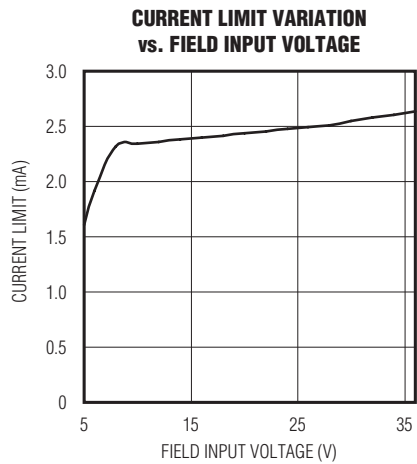
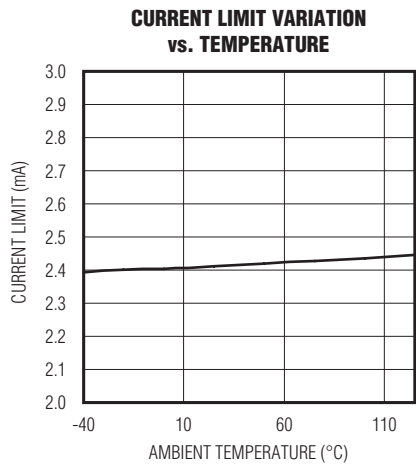
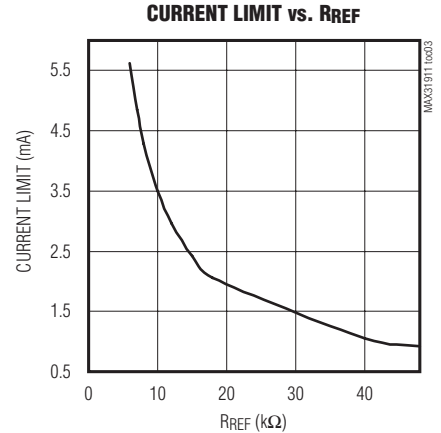
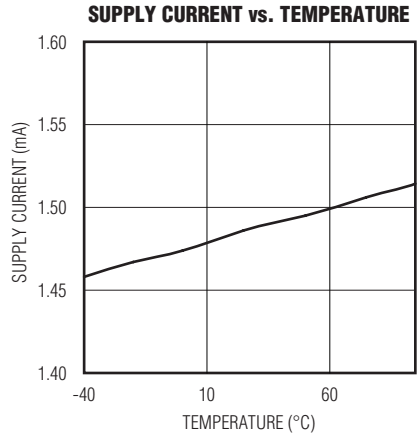
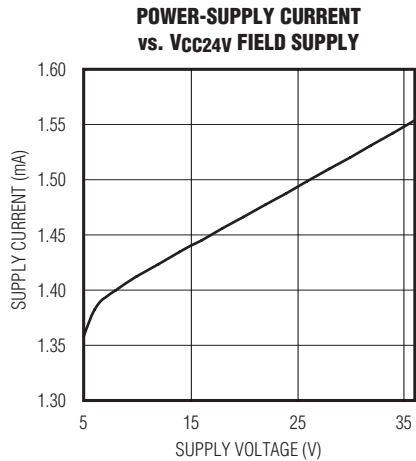

MAX31911

Industrial, Octal, Digital Input Translator/Serializer

Typical Operating Characteristics (continued)

($T_A = +25^\circ\text{C}$, $R_{REF} = 15\text{k}\Omega$, unless otherwise noted.)

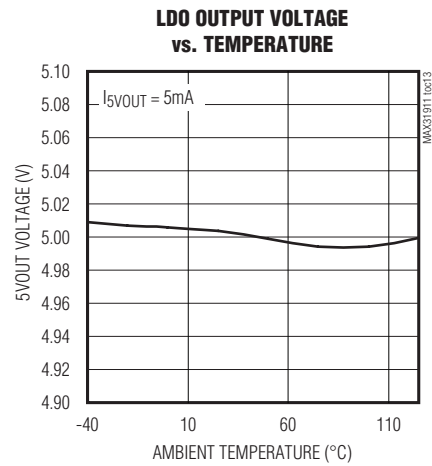
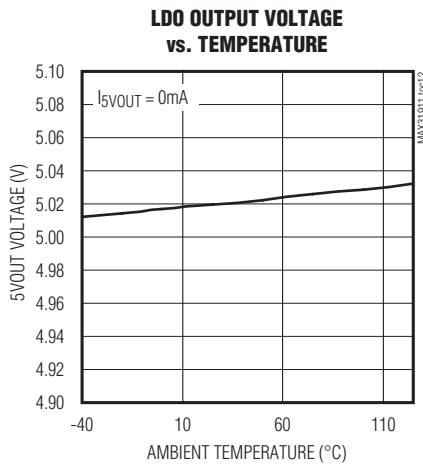
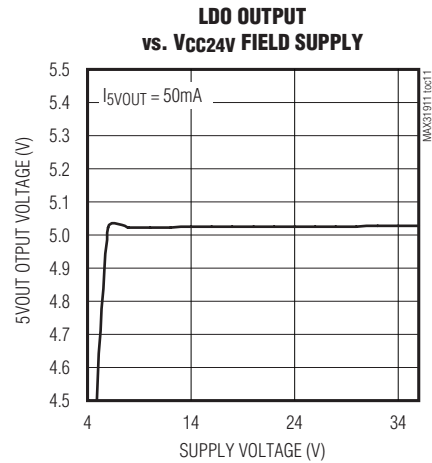
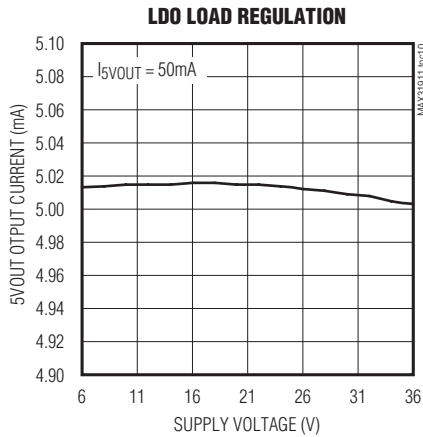

MAX31911

Industrial, Octal, Digital Input Translator/Serializer

Pin Configuration

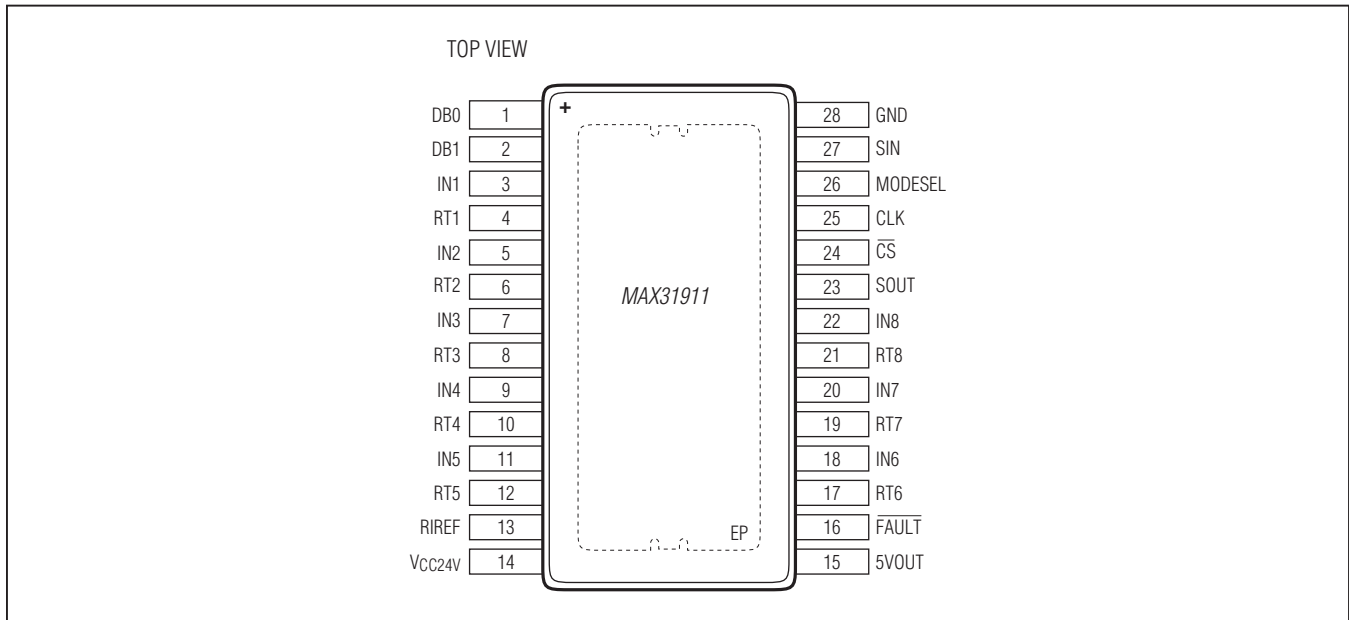

Pin Description

PIN	NAME	FUNCTION
1, 2	DB0, DB1	Debounce (Filtering) Time Select Inputs
3, 5, 7, 9, 11, 18, 20, 22	IN1–IN8	Field Inputs
4, 6, 8, 10, 12, 17, 19, 21	RT1–RT8	Connect directly to GND. These pins are reserved for energy-less LED drives in future versions of the device.
13	RIREF	Current-Limiter Reference Resistor
14	V _{CC24V}	Field-Supply Voltage
15	5VOUT	5V Regulator Output
16	FAULT	Active-Low Overtemperature or Undervoltage Alarm
23	SOUT	Serial-Data Out
24	CS	Active-Low Chip-Select Input
25	CLK	Serial-Clock Input
26	MODESEL	Mode-Select Input MODESEL = 1: Selects 8-bit shift register MODESEL = 0: Selects 16-bit shift register
27	SIN	Serial-Data Input
28	GND	Field Ground
—	EP	Exposed Pad. Must be connected to the PCB ground plane.

MAX31911

Industrial, Octal, Digital Input Translator/Serializer

Typical Application Circuit

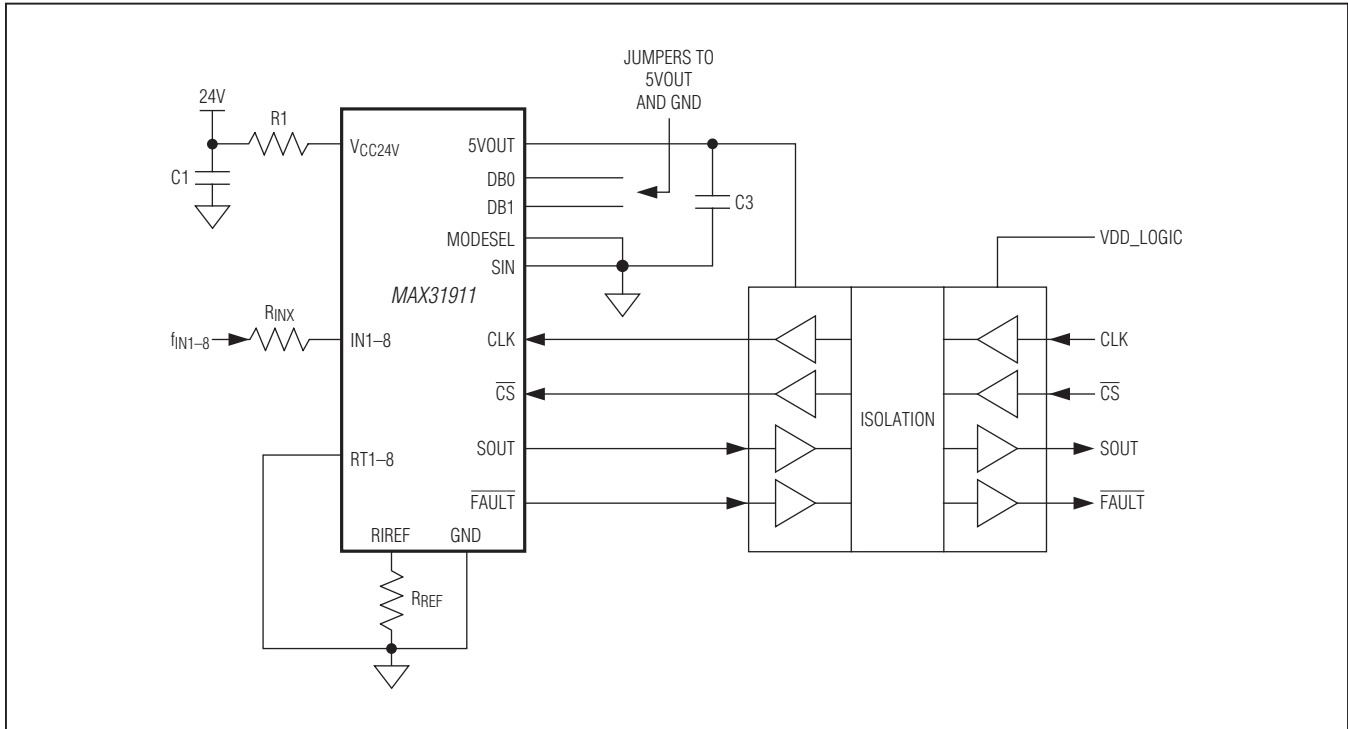

Detailed Description

Input Current Clamp

The MAX31911 industrial interface serializer inputs (IN1–IN8) sense the state (on vs. off) of field sensors by monitoring both voltage and current flowing through the sensor output. The current sinking through these input pins rises linearly with input voltage until the limit set by the current clamp is reached. Any voltage increase beyond this point does not increase the input current any further.

The value of the current clamp is adjustable through an external resistor connected between the RIREF pin and GND. Pins RT0–RT7 must be connected directly to GND to provide a return path for the input current. The voltage and current at the IN1–IN8 input pins are compared against internally set references to deter-

mine whether the sensor is on (logic 1) or off (logic 0). The trip points determining the on/off status of the sensor satisfy the requirements of IEC 61131-2 Type 1 and 3 switches. The device can also be configured to work as a Type 2 switch.

Glitch Filter

A digital glitch filter provides debouncing and filtering of noisy sensor signals. The time constant of this filter is programmable from 0ms to 3ms through the DB0 and DB1 pins. See [Table 1](#) for debounce settings.

To provide the digital glitch filter, the device checks that an input is stable for at least three clock cycles. The duration of a clock cycle is 1/3 of the selected debounce time. If the input is not stable for at least three clock cycles, the input change is not sent to the internal shift register.

MAX31911

Industrial, Octal, Digital Input Translator/Serializer

Reading Serial Data

The filtered outputs of the input comparators are latched into a shift register at the falling edge of \overline{CS} . Clocking the CLK pin, while \overline{CS} is held low, shifts the latched data out of SOUT 1 bit at a time.

The internal data serializer comprises a 16-bit shift register, containing 8 bits of data corresponding to the eight field inputs, as well as an 8-bit status byte containing supplementary status and CRC information. The status byte contains 1 bit representing the status of the field-supply voltage (UV), 1 bit representing the status of the internal temperature monitor (OT), a 5-bit CRC code internally calculated and generated, and a trailing 1 as a STOP bit.

The undervoltage (UV) bit is normally 0. If the supply voltage falls below $V_{OFFUVLO}$, the UV becomes a 1. The UV bit returns to 0 once the supply voltage has returned above V_{ONUVLO} .

The overtemperature (OT) bit is also normally 0. If the junction temperature increases to above T_{ALRM} , the OT bit becomes a 1. The bit returns to 0 once the junction temperature has returned below T_{ALRM} .

The CRC code can be used to check data integrity during transfer from the device to an external microcontroller. In applications where the integrity of data transferred is not of concern, the CRC bits can be ignored. The CRC uses the following polynomial:

$$P(x) = x^5 + x^4 + x^2 + x^0$$

The number of bits in the internal serializer can be selected between 8 bits or 16 bits. The MODESEL pin is used to configure the serializer as an 8-bit (disabling the status byte) or 16-bit shift register.

In 8-bit mode, only the eight field input states are transferred through the SPI port and the status byte is ignored. Therefore, in multiple IC applications (input channels greater than 8), if desired, only a single status byte can be generated and transmitted for any number of input channels.

The shift register contents are read only (no write capability exists) through the SPI-compatible interface.

For higher input counts than 8, multiple devices can be cascaded. In this case, the SOUT pin of one device should be connected to the SIN pin of the next device, effectively cascading the internal shift registers. The CLK and \overline{CS} pins of all the devices should be connected together in this configuration. See the [Serial-Port Operation](#) section for more detailed information on operating the SPI interface.

Temperature Monitoring

The internal junction temperature of the device is constantly monitored. An alarm is raised, by asserting the \overline{FAULT} pin, if the temperature rises above T_{ALRM} . In addition to asserting \overline{FAULT} , the device sets the OT bit to a 1.

Supply Voltage Monitoring

A supply voltage monitor circuit constantly monitors the field-supply voltage. If this voltage falls below a threshold ($V_{OFFUVLO}$), an alarm is raised by asserting the \overline{FAULT} pin, indicating that the part is experiencing a fault condition and the data in the serializer is not to be trusted. In addition, the device sets the UV bit to a 1. Once the field-supply voltage has recovered and goes above V_{ONUVLO} , the \overline{FAULT} pin is released, indicating normal operation of the part.

Table 1. Debounce Settings

DB1	DB0	BINARY VALUE	DEBOUNCE TIME
0	0	0	0
0	1	1	25 μ s
1	0	2	0.75ms
1	1	3	3ms

MAX31911

Industrial, Octal, Digital Input Translator/Serializer

Serial-Port Operation

Serial output of the device functions in one of two modes, depending on the MODESEL setting (Table 3). With MODESEL = 0, the device output includes a 5-bit CRC, an undervoltage alarm, and an overtemperature alarm. See the [Detailed Description](#) for CRC, undervoltage, and overtemperature functional descriptions. With MODESEL = 1, the device outputs only the state of the IN1–IN8 inputs and omits the CRC, undervoltage alarm, and overtemperature alarm.

Daisy-Chain Operation

For systems with more than eight sensor inputs, multiple devices can be daisy-chained to allow access to all data inputs through a single serial port. When using a daisy-chain configuration, connect SOUT of one of the devices to the SIN input of another upstream device. \overline{CS} and SCK of all devices in the chain should be connected together

in parallel (see [Figure 2](#)). In a daisy-chain configuration, external components used to enhance EMC robustness do not need to be duplicated for each device of a circuit board. [Figure 3](#) illustrates a 16-input application.

SPI Waveforms

The serial output of the device adheres to the SPI protocol, running with CPHA = 0 and CPOL = 0. Input states on IN1–IN8 are latched in on the falling edge of \overline{CS} . The transfer of data out of the slave output, SOUT, starts immediately when \overline{CS} is asserted (i.e., MSB is output onto SOUT independent of CLK). The remaining data bits are shifted out on the falling edge of CLK. The data bits are written to the output SOUT with MSB first. When \overline{CS} is high, SOUT is high impedance. The resultant timing is shown in [Figure 4](#). Note that all bits after IN1 are invalid if 8-bit operation mode is selected with the MODESEL input. [Figure 5](#), [Figure 6](#), [Figure 7](#), and [Figure 8](#) illustrate SPI timing specifications.

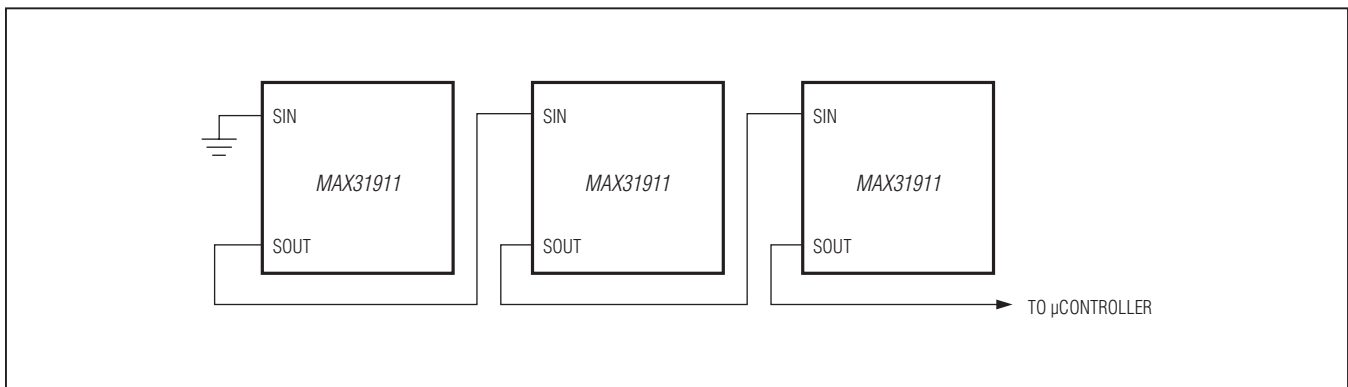

Figure 2. Daisy-Chain Operation

Table 3. MODESEL Settings

MODESEL SETTING	FUNCTIONALITY
0	16-bit output; [IN8–IN1][CRC (5 bit)][UV][OT][X]
1	8-bit output; [IN8–IN1]

MAX31911

Industrial, Octal, Digital Input Translator/Serializer

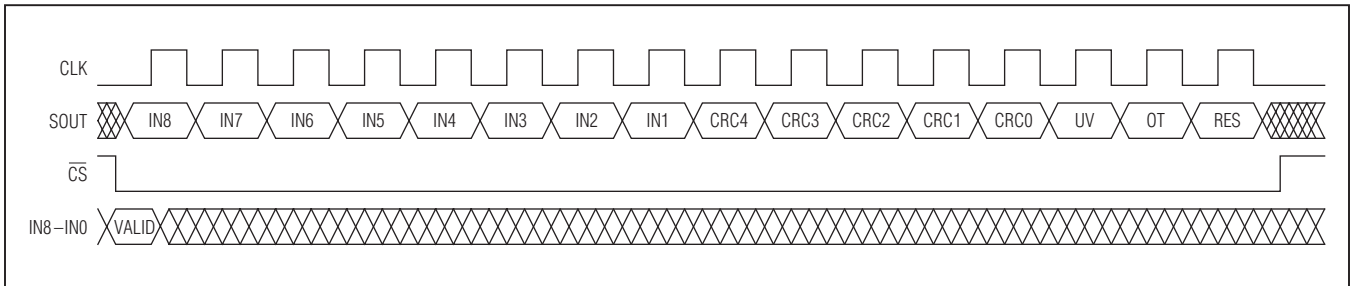

Figure 4. SPI Communication Example

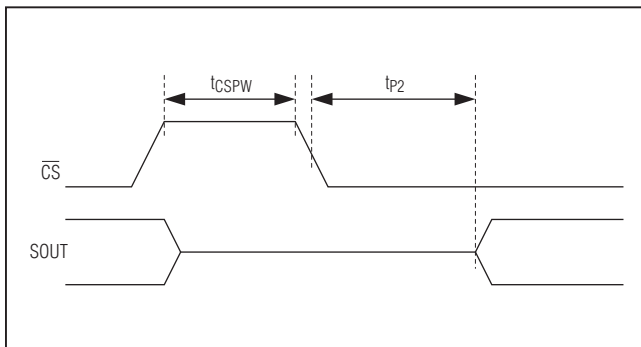

Figure 5. SPI Timing Diagram 1

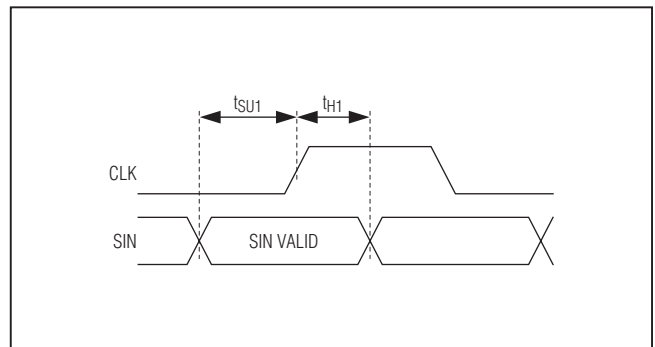

Figure 7. SPI Timing Diagram 3

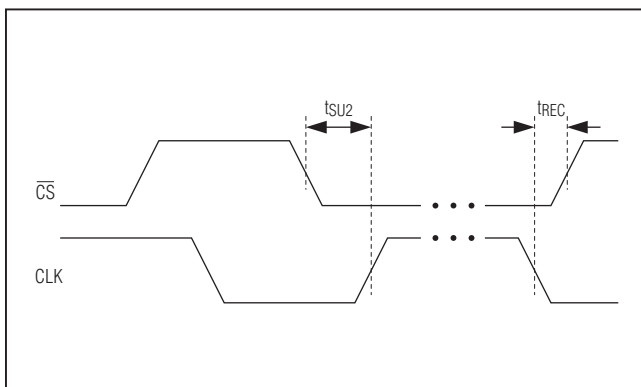

Figure 6. SPI Timing Diagram 2

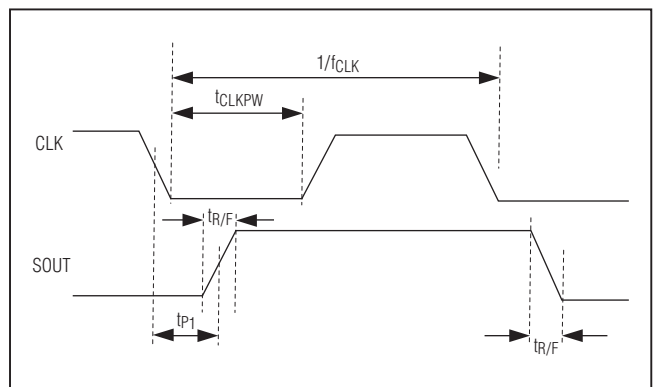

Figure 8. SPI Timing Diagram 4

MAX31911

Industrial, Octal, Digital Input Translator/Serializer

Chip Information

PROCESS: S45JRS

Ordering Information

PART	TEMP RANGE	PIN-PACKAGE	CARRIER
MAX31911AUI+	-40°C to +125°C	28 TSSOP	Bulk
MAX31911AUI+T	-40°C to +125°C	28 TSSOP	Tape and Reel

+Denotes a lead(Pb)-free/RoHS-compliant package.

T = Tape and reel.

Package Information

For the latest package outline information and land patterns (footprints), go to www.maximintegrated.com/packages. Note that a "+", "#", or "-" in the package code indicates RoHS status only. Package drawings may show a different suffix character, but the drawing pertains to the package regardless of RoHS status.

PACKAGE TYPE	PACKAGE CODE	OUTLINE NO.	LAND PATTERN NO.
28 TSSOP-EP	U28E+4	21-0108	90-0146

MAX31911

Industrial, Octal, Digital Input Translator/Serializer

Revision History

REVISION NUMBER	REVISION DATE	DESCRIPTION	PAGES CHANGED
0	8/12	Initial release	—
1	9/12	Changed the supply voltage minimum from 10V to 7V; changed the current limits in the EC table Note 5; added the CRC polynomial to the <i>Reading Serial Data</i> section	1–4, 9



Maxim Integrated cannot assume responsibility for use of any circuitry other than circuitry entirely embodied in a Maxim Integrated product. No circuit patent licenses are implied. Maxim Integrated reserves the right to change the circuitry and specifications without notice at any time. The parametric values (min and max limits) shown in the Electrical Characteristics table are guaranteed. Other parametric values quoted in this data sheet are provided for guidance.

Maxim Integrated 160 Rio Robles, San Jose, CA 95134 USA 1-408-601-1000

15

Компания «Океан Электроники» предлагает заключение долгосрочных отношений при поставках импортных электронных компонентов на взаимовыгодных условиях!

Наши преимущества:

- Поставка оригинальных импортных электронных компонентов напрямую с производств Америки, Европы и Азии, а так же с крупнейших складов мира;
- Широкая линейка поставок активных и пассивных импортных электронных компонентов (более 30 млн. наименований);
- Поставка сложных, дефицитных, либо снятых с производства позиций;
- Оперативные сроки поставки под заказ (от 5 рабочих дней);
- Экспресс доставка в любую точку России;
- Помощь Конструкторского Отдела и консультации квалифицированных инженеров;
- Техническая поддержка проекта, помощь в подборе аналогов, поставка прототипов;
- Поставка электронных компонентов под контролем ВП;
- Система менеджмента качества сертифицирована по Международному стандарту ISO 9001;
- При необходимости вся продукция военного и аэрокосмического назначения проходит испытания и сертификацию в лаборатории (по согласованию с заказчиком);
- Поставка специализированных компонентов военного и аэрокосмического уровня качества (Xilinx, Altera, Analog Devices, Intersil, Interpoint, Microsemi, Actel, Aeroflex, Peregrine, VPT, Syfer, Eurofarad, Texas Instruments, MS Kennedy, Miteq, Cobham, E2V, MA-COM, Hittite, Mini-Circuits, General Dynamics и др.);

Компания «Океан Электроники» является официальным дистрибьютором и эксклюзивным представителем в России одного из крупнейших производителей разъемов военного и аэрокосмического назначения «**JONHON**», а так же официальным дистрибьютором и эксклюзивным представителем в России производителя высокотехнологичных и надежных решений для передачи СВЧ сигналов «**FORSTAR**».



JONHON

«**JONHON**» (основан в 1970 г.)

Разъемы специального, военного и аэрокосмического назначения:

(Применяются в военной, авиационной, аэрокосмической, морской, железнодорожной, горно- и нефтедобывающей отраслях промышленности)

«**FORSTAR**» (основан в 1998 г.)

ВЧ соединители, коаксиальные кабели, кабельные сборки и микроволновые компоненты:

(Применяются в телекоммуникациях гражданского и специального назначения, в средствах связи, РЛС, а так же военной, авиационной и аэрокосмической отраслях промышленности).



Телефон: 8 (812) 309-75-97 (многоканальный)

Факс: 8 (812) 320-03-32

Электронная почта: ocean@oceanchips.ru

Web: <http://oceanchips.ru/>

Адрес: 198099, г. Санкт-Петербург, ул. Калинина, д. 2, корп. 4, лит. А