

MINIATURE RELAY

2 POLES—1 to 2 A (FOR SIGNAL SWITCHING)

RY SERIES

RoHS compliant



■ FEATURES

- Ultra high sensitivity
- UL, CSA recognized
- Conforms to FCC rules and regulations Part 68 —Surge strength 1,500 V
- High dielectric strength type available (RY-WF type)
- Contact arrangement MBB type available (RY-D type)
- High reliability-bifurcated contacts
- Wide operating range
- DIL pitch terminals
- Plastic sealed type
- RoHS compliant since date code: 0438B9
Please see page 8 for more information



■ ORDERING INFORMATION

[Example] $\frac{\text{RY}}{\text{(a) (*)}}$ - $\frac{\text{12}}{\text{(b)}}$ $\frac{\text{WF}}{\text{(c)}}$ - $\frac{\text{K}}{\text{(d)}}$

| | | |
|-----|---------------------------|---|
| (a) | Series Name | RY : RY Series |
| (b) | Nominal Voltage | Refer to the COIL DATA CHART |
| (c) | Coil and Contact Function | W : High sensitive type WZ : Nominal 0.5 W type WF : High dielectric strength type WFZ : 2 A type D : 2 FORM D (2 MBB type) |
| (d) | Enclosure | K : Plastic sealed type |

Note: Actual marking omits the hyphen (-) of (*)
For movable and stationary contact with gold overlay type, add suffix “-OH”.

RY SERIES

■ COIL DATA CHART

| | MODEL | Nominal voltage | Coil resistance (±10%) | Must operate voltage | Must release voltage | Nominal power |
|--------------------------|--------------|-----------------|------------------------|----------------------|----------------------|---------------|
| High Sensitive Type | RY-4.5 W-K | 4.5 VDC | 135Ω | 3.2 VDC | 0.23 VDC | 150 mW |
| | RY- 5 W-K | 5 VDC | 165Ω | 3.6 VDC | 0.25 VDC | 150 mW |
| | RY- 6 W-K | 6 VDC | 240Ω | 4.3 VDC | 0.3 VDC | 150 mW |
| | RY- 9 W-K | 9 VDC | 540Ω | 6.4 VDC | 0.45 VDC | 150 mW |
| | RY- 12 W-K | 12 VDC | 960Ω | 8.5 VDC | 0.6 VDC | 150 mW |
| | RY- 18 W-K | 18 VDC | 1,620Ω | 12.6 VDC | 0.9 VDC | 200 mW |
| | RY- 24 W-K | 24 VDC | 2,880Ω | 16.8 VDC | 1.2 VDC | 200 mW |
| | RY- 48 W-K | 48 VDC | 7,680Ω | 32.6 VDC | 2.4 VDC | 300 mW |
| 500 mW Type | RY- 3 WZ-K | 3 VDC | 18Ω | 1.5 VDC | 0.15 VDC | 500 mW |
| | RY-4.5 WZ-K | 4.5 VDC | 36Ω | 2.25 VDC | 0.23 VDC | 560 mW |
| | RY- 5 WZ-K | 5 VDC | 45Ω | 2.5 VDC | 0.25 VDC | 560 mW |
| | RY- 6 WZ-K | 6 VDC | 66Ω | 3.0 VDC | 0.3 VDC | 550 mW |
| | RY- 9 WZ-K | 9 VDC | 140Ω | 4.5 VDC | 0.45 VDC | 580 mW |
| | RY- 12 WZ-K | 12 VDC | 280Ω | 6.0 VDC | 0.6 VDC | 510 mW |
| | RY- 18 WZ-K | 18 VDC | 560Ω | 9.0 VDC | 0.9 VDC | 580 mW |
| | RY- 24 WZ-K | 24 VDC | 1,070Ω | 12.0 VDC | 1.2 VDC | 540 mW |
| RY- 48 WZ-K | 48 VDC | 4,000Ω | 24.0 VDC | 2.4 VDC | 580 mW | |
| High Dielectric Strength | RY- 5 WF-K | 5 VDC | 56Ω | 3.3 VDC | 0.25 VDC | 450 mW |
| | RY- 6 WF-K | 6 VDC | 80Ω | 4.0 VDC | 0.3 VDC | 450 mW |
| | RY- 9 WF-K | 9 VDC | 180Ω | 6.0 VDC | 0.45 VDC | 450 mW |
| | RY- 12 WF-K | 12 VDC | 320Ω | 8.0 VDC | 0.6 VDC | 450 mW |
| | RY- 18 WF-K | 18 VDC | 720Ω | 12.0 VDC | 0.9 VDC | 450 mW |
| | RY- 24 WF-K | 24 VDC | 1,260Ω | 15.9 VDC | 1.2 VDC | 450 mW |
| | RY- 48 WF-K | 48 VDC | 5,000Ω | 33.0 VDC | 2.4 VDC | 460 mW |
| 2 A Type | RY- 3 WFZ-K | 3 VDC | 18Ω | 1.9 VDC | 0.15 VDC | 500 mW |
| | RY-4.5 WFZ-K | 4.5 VDC | 36Ω | 2.9 VDC | 0.23 VDC | 560 mW |
| | RY- 5 WFZ-K | 5 VDC | 45Ω | 3.2 VDC | 0.25 VDC | 560 mW |
| | RY- 6 WFZ-K | 6 VDC | 66Ω | 3.8 VDC | 0.3 VDC | 550 mW |
| | RY- 9 WFZ-K | 9 VDC | 140Ω | 5.7 VDC | 0.45 VDC | 580 mW |
| | RY- 12 WFZ-K | 12 VDC | 280Ω | 7.6 VDC | 0.6 VDC | 510 mW |
| | RY- 18 WFZ-K | 18 VDC | 560Ω | 11.4 VDC | 0.9 VDC | 580 mW |
| | RY- 24 WFZ-K | 24 VDC | 1,070Ω | 15.2 VDC | 1.2 VDC | 540 mW |
| | RY -48 WFZ-K | 48 VDC | 4,000Ω | 36.0 VDC | 2.4 VDC | 580 mW |

Note : All values in the table are measured at 20°C.

RY SERIES

| | MODEL | Nominal voltage | Coil resistance ($\pm 10\%$) | Must operate voltage | Must release voltage | Nominal power |
|-----------------------|------------|-----------------|--------------------------------|----------------------|----------------------|---------------|
| Continuous (MBB) Type | RY-4.5 D-K | 4.5 VDC | 45 Ω | 3.0 VDC | 0.23 VDC | 450 mW |
| | RY- 5 D-K | 5 VDC | 55 Ω | 3.3 VDC | 0.25 VDC | 450 mW |
| | RY- 6 D-K | 6 VDC | 80 Ω | 3.95 VDC | 0.3 VDC | 450 mW |
| | RY- 9 D-K | 9 VDC | 180 Ω | 5.9 VDC | 0.45 VDC | 450 mW |
| | RY- 12 D-K | 12 VDC | 320 Ω | 7.9 VDC | 0.6 VDC | 450 mW |
| | RY- 18 D-K | 18 VDC | 720 Ω | 11.8 VDC | 0.9 VDC | 450 mW |
| | RY- 24 D-K | 24 VDC | 1,280 Ω | 15.8 VDC | 1.2 VDC | 450 mW |
| | RY- 48 D-K | 48 VDC | 4,800 Ω | 31.8 VDC | 2.4 VDC | 480 mW |

Note : All values in the table are measured at 20°C.

■ SPECIFICATIONS

| Item | | High Sensitive Type | 500 mW Type | High Dielectric Strength | 2 A Type | Continuous (MBB) Type | |
|------------------------|----------------------------------|---|---|--|---|--|-----------------|
| | | RY-() W-K | RY-() WZ-K | RY-() WF-K | RY-() WFZ-K | RY-() D-K | |
| Contact | Arrangement | 2 form C (DPDT) | | | | 2 Form D (2 MBB) | |
| | Material | Gold overlay silver-palladium | | | Gold overlay silver-nickel | Gold overlay silver-palladium | |
| | Style | Bifurcated (cross bar) | | | | Single | |
| | Resistance (initial) | Maximum 100 mΩ (at 1 A 6 VDC) | | | | | |
| | Maximum Carrying Current | 1.25 A | | | 2 A | 0.6 A | |
| | Rating (resistive) | 1 A 24 VD 0.5 A 120 VAC | | 1 A 24 VDC 0.25 A 120 VAC | 2 A 30 VDC 0.5 A 125 VAC | 0.15 A 48 VDC 0.3 A 120 VAC | |
| | Maximum Switching Power | 60 VA/24 W | | 30 VA/24 W | 62.5 VA/60 W | | 36 VA/7.2 W |
| | Maximum Switching Voltage | 120 VAC, 60 VDC | | | 125 VAC, 150 VDC | | 120 VAC, 60 VDC |
| | Maximum Switching Current | 1 A | | | 2 A | 0.6 A | |
| | Minimum Switching Load*1 | 0.01 mA 10 mVDC | | | | 0.1 mA 10 mVDC | |
| Capacitance (at 10MHz) | | Approx. 0.9 pF (between open contacts) 1.4 pF (adjacent contacts) Approx. 1.9 pF (between coil and contacts) | | | | | |
| Coil | Nominal Power (at 20°C) | 150 to 300 mW | 500 to 580 mW | 450 to 460 mW | 500 to 580 mW | 450 to 480 mW | |
| | Operate Power (at 20°C) | 75 to 140 mW | 125 to 145 mW | 200 to 210 mW | 200 to 324 mW | 200 to 210 mW | |
| | Operating Temperature (No frost) | -30°C to +90°C (*+80°C) | -30°C to +60°C (refer to the CHARACTERISTIC DATA) | | | -30°C to +70°C (*2 +65°C) | |
| Time Value | Operate (at nominal voltage) | Maximum 6 ms | | | | | |
| | Release (at nominal voltage) | Maximum 3 ms | | | | | |
| Life | Mechanical | 2 × 10 ⁷ ops. min. 1 × 10 ⁷ operations minimum | | | | 1 × 10 ⁶ ops. min. | |
| | Electrical (at contact rating) | 2 × 10 ⁵ ops. min. (0.5 A 120 VAC) 5 × 10 ⁵ ops. min. (1 A 24 VD C) | | 5 × 10 ⁵ ops. min. (0.25 A 120 VAC 1 A 24 VDC | 1 × 10 ⁵ ops. min. (2 A 30 VDC) | 2 × 10 ⁵ opsmin. (0.3 A 120 VAC) 5 × 10 ⁵ ops. min. (0.15 A 48 VDC) | |
| Other | Vibration | Misoperation | 10 to 55 Hz (double amplitude of 1.5 mm) | | | | |
| | Resistance | Endurance | 10 to 55 Hz (double amplitude of 4.5 mm) | | | | |
| | Shock | Misoperation | 100 m/s ² (11±1 ms) | | | | |
| | Resistance | Endurance | 1,000 m/s ² (6±1 ms) | | | | |
| | Weight | Approximately 5 g | | | | | |

*1 Minimum switching loads mentioned above are reference values. Please perform the confirmation test with the actual load before production since reference values may vary according to switching frequencies, environmental conditions and expected reliability levels.

*2 48VDC type

■ INSULATION

| Item | Sensitive | 500mW | High Isolation | 2A | MBB |
|---------------------|--|------------------|----------------|------------------|----------------|
| Isolation (initial) | Minimum 1,000 MΩ (at 500VDC) | | | | |
| Dielectric Strength | open contact | 500VAC 1 min., | | 1,000VAC 1 min., | 500VAC 1 min., |
| | coil and contact/ adjacent contacts | 1,000VAC 1 min., | | | |
| Surge Voltage | 1500V (coil-contact) (10/160 μs standard wave) | | | | |

SAFETY STANDARDS

| Type | Compliance | Contact rating |
|------|---------------------------|---|
| UL | UL 478, UL 508 E 45026 | Flammability: UL 94-V0 (plastics) [RY-W, RY-WZ] |
| CSA | C22.2 No. 14 LR 35579 | 0.5A, 120VAC (resistive) 1A, 24VDC (resistive) 0.3A, 60VDC (resistive) [RY-WF] 0.25A, 120VAC (resistive) 1A, 24VDC (resistive) 0.3A, 60VDC (resistive) [RY-D] 0.3A, 120VAC (resistive) 0.2A, 60VDC (resistive) [RY-WFZ] (only CSA) 0.5A, 125VAC (resistive) 2A, 30VDC (resistive) 0.6A, 110VDC (resistive) |

CHARACTERISTIC DATA

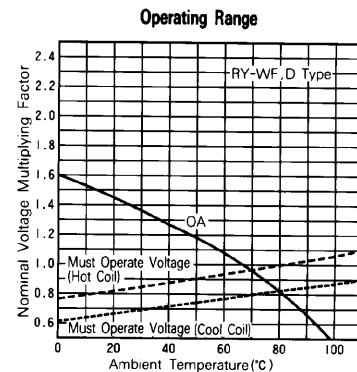
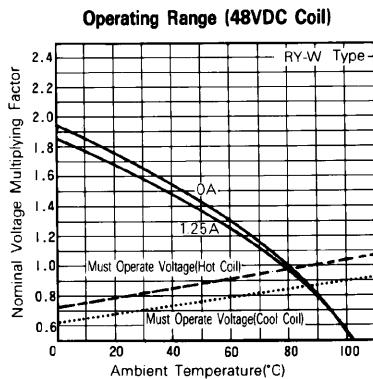
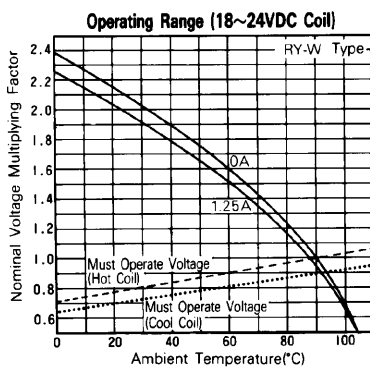
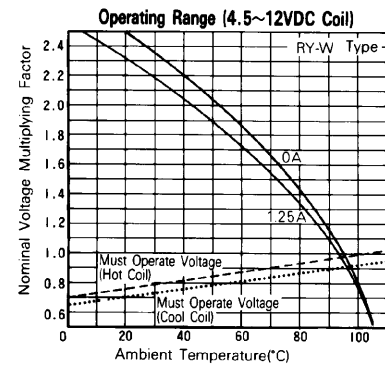
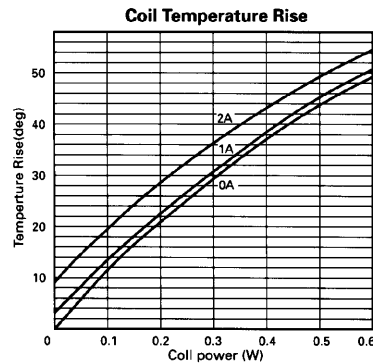
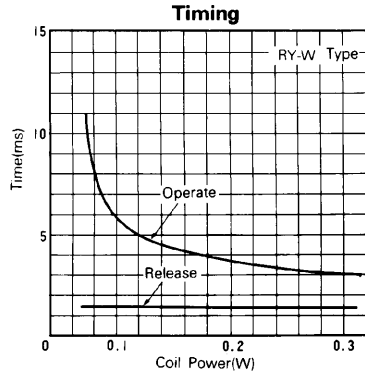

CHARACTERISTIC DATA



REFERENCE DATA



■ REFERENCE DATA

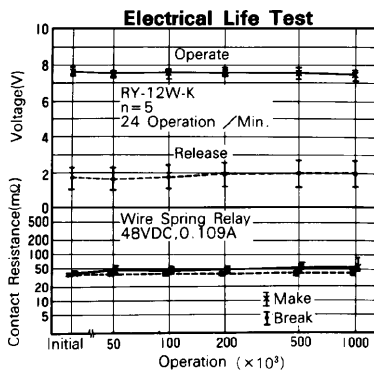

■ DIMENSIONS

● Dimensions

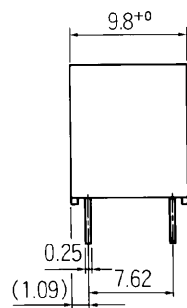
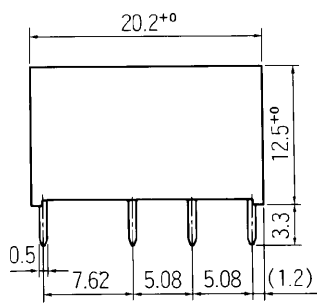

● Schematics (Bottom view)



● PC board mounting hole layout (Bottom view)



Unit: mm

RoHS Compliance and Lead Free Relay Information

1. General Information

- Relays produced after the specific date code that is indicated on each data sheet are lead-free now. Most of our signal and power relays are lead-free. Please refer to Lead-Free Status Info. (<http://www.fujitsu.com/us/downloads/MICRO/fcai/relays/lead-free-letter.pdf>)
- Lead free solder paste currently used in relays is Sn-3.0Ag-0.5Cu.
- All signal and most power relays also comply with RoHS. Please refer to individual data sheets. Relays that are RoHS compliant do not contain the 5 hazardous materials that are restricted by RoHS directive (lead, mercury, chromium IV, PBB, PBDE).
- It has been verified that using lead-free relays in lead assembly process will not cause any problems (compatible).
- "LF" is marked on each outer and inner carton. (No marking on individual relays).
- To avoid leaded relays (for lead-free sample, etc.) please consult with area sales office.
- We will ship leaded relays as long as the leaded relay inventory exists.

Note: Cadmium was exempted from RoHS on October 21, 2005. (Amendment to Directive 2002/95/EC)

2. Recommended Lead Free Solder Profile

- Recommended solder paste Sn-3.0Ag-0.5Cu.

Reflow Solder condition

Flow Solder condition:

Pre-heating: maximum 120°C
Soldering: dip within 5 sec. at
260°C solder bath

Solder by Soldering Iron:

Soldering Iron
Temperature: maximum 360°C
Duration: maximum 3 sec.

We highly recommend that you confirm your actual solder conditions

3. Moisture Sensitivity

- Moisture Sensitivity Level standard is not applicable to electromechanical relays.

4. Tin Whisker

- Dipped SnAgCu solder is known as low risk tin whisker. No considerable length whisker was found by our in house test.

Fujitsu Components International Headquarter Offices

Japan

Fujitsu Component Limited
Gotanda-Chuo Building
3-5, Higashigotanda 2-chome, Shinagawa-ku
Tokyo 141, Japan
Tel: (81-3) 5449-7010
Fax: (81-3) 5449-2626
Email: promothq@ft.ed.fujitsu.com
Web: www.fcl.fujitsu.com

North and South America

Fujitsu Components America, Inc.
250 E. Caribbean Drive
Sunnyvale, CA 94089 U.S.A.
Tel: (1-408) 745-4900
Fax: (1-408) 745-4970
Email: components@us.fujitsu.com
Web: <http://www.fujitsu.com/us/services/edevices/components/>

Europe

Fujitsu Components Europe B.V.
Diamantlaan 25
2132 WV Hoofddorp
Netherlands
Tel: (31-23) 5560910
Fax: (31-23) 5560950
Email: info@fceu.fujitsu.com
Web: emea.fujitsu.com/components/

Asia Pacific

Fujitsu Components Asia Ltd.
102E Pasir Panjang Road
#01-01 Citilink Warehouse Complex
Singapore 118529
Tel: (65) 6375-8560
Fax: (65) 6273-3021
Email: fcal@fcal.fujitsu.com
Web: <http://www.fujitsu.com/sg/services/micro/components/>

©2008 Fujitsu Components America, Inc. All rights reserved. All trademarks or registered trademarks are the property of their respective owners.

Fujitsu Components America or its affiliates do not warrant that the content of datasheet is error free. In a continuing effort to improve our products Fujitsu Components America, Inc. or its affiliates reserve the right to change specifications/datasheets without prior notice.
Rev. January 18, 2008.

Компания «Океан Электроники» предлагает заключение долгосрочных отношений при поставках импортных электронных компонентов на взаимовыгодных условиях!

Наши преимущества:

- Поставка оригинальных импортных электронных компонентов напрямую с производств Америки, Европы и Азии, а так же с крупнейших складов мира;
- Широкая линейка поставок активных и пассивных импортных электронных компонентов (более 30 млн. наименований);
- Поставка сложных, дефицитных, либо снятых с производства позиций;
- Оперативные сроки поставки под заказ (от 5 рабочих дней);
- Экспресс доставка в любую точку России;
- Помощь Конструкторского Отдела и консультации квалифицированных инженеров;
- Техническая поддержка проекта, помощь в подборе аналогов, поставка прототипов;
- Поставка электронных компонентов под контролем ВП;
- Система менеджмента качества сертифицирована по Международному стандарту ISO 9001;
- При необходимости вся продукция военного и аэрокосмического назначения проходит испытания и сертификацию в лаборатории (по согласованию с заказчиком);
- Поставка специализированных компонентов военного и аэрокосмического уровня качества (Xilinx, Altera, Analog Devices, Intersil, Interpoint, Microsemi, Actel, Aeroflex, Peregrine, VPT, Syfer, Eurofarad, Texas Instruments, MS Kennedy, Miteq, Cobham, E2V, MA-COM, Hittite, Mini-Circuits, General Dynamics и др.);

Компания «Океан Электроники» является официальным дистрибьютором и эксклюзивным представителем в России одного из крупнейших производителей разъемов военного и аэрокосмического назначения «JONHON», а так же официальным дистрибьютором и эксклюзивным представителем в России производителя высокотехнологичных и надежных решений для передачи СВЧ сигналов «FORSTAR».



JONHON

«JONHON» (основан в 1970 г.)

Разъемы специального, военного и аэрокосмического назначения:

(Применяются в военной, авиационной, аэрокосмической, морской, железнодорожной, горно- и нефтедобывающей отраслях промышленности)

«FORSTAR» (основан в 1998 г.)

ВЧ соединители, коаксиальные кабели, кабельные сборки и микроволновые компоненты:

(Применяются в телекоммуникациях гражданского и специального назначения, в средствах связи, РЛС, а так же военной, авиационной и аэрокосмической отраслях промышленности).



Телефон: 8 (812) 309-75-97 (многоканальный)

Факс: 8 (812) 320-03-32

Электронная почта: ocean@oceanchips.ru

Web: <http://oceanchips.ru/>

Адрес: 198099, г. Санкт-Петербург, ул. Калинина, д. 2, корп. 4, лит. А