



TABLE OF CONTENTS

1. GENERAL DESCRIPTION	4
2. FEATURES	4
3. PIN CONFIGURATION	5
3.1 Ball Assignment: LPDDR X16	5
3.2 Ball Assignment: LPDDR X32	5
4. PIN DESCRIPTION	6
4.1 Signal Descriptions	6
4.2 Addressing Table	7
5. BLOCK DIAGRAM	8
5.1 Block Diagram	8
5.2 Simplified State Diagram	9
6. FUNCTION DESCRIPTION	10
6.1 Initialization	10
6.1.1 Initialization Flow Diagram	11
6.1.2 Initialization Waveform Sequence	12
6.2 Register Definition	12
6.2.1 Mode Register Set Operation	12
6.2.2 Mode Register Definition	13
6.2.3. Burst Length	13
6.3 Burst Definition	14
6.4 Burst Type	15
6.5 Read Latency	15
6.6 Extended Mode Register Description	15
6.6.1 Extended Mode Register Definition	16
6.7 Status Register Read	16
6.7.1 SRR Register (A[n:0] = 0)	17
6.7.2 Status Register Read Timing Diagram	18
6.8 Partial Array Self Refresh	19
6.9 Automatic Temperature Compensated Self Refresh	19
6.10 Output Drive Strength	19
6.11 Commands	19
6.11.1 Basic Timing Parameters for Commands	19
6.11.2 Truth Table - Commands	20
6.11.3 Truth Table - DM Operations	21
6.11.4 Truth Table - CKE	21
6.11.5 Truth Table - Current State BANKn - Command to BANKn	22
6.11.6 Truth Table - Current State BANKn, Command to BANKn	23
7. OPERATION	24
7.1. Deselect	24
7.2. No Operation	24
7.2.1 NOP Command	25



7.3 Mode Register Set.....	25
7.3.1 Mode Register Set Command.....	25
7.3.2 Mode Register Set Command Timing.....	26
7.4. Active	26
7.4.1 Active Command.....	26
7.4.2 Bank Activation Command Cycle.....	27
7.5. Read	27
7.5.1 Read Command.....	28
7.5.2 Basic Read Timing Parameters	28
7.5.3 Read Burst Showing CAS Latency	29
7.5.4 Read to Read	29
7.5.5 Consecutive Read Bursts.....	30
7.5.6 Non-Consecutive Read Bursts.....	30
7.5.7 Random Read Bursts.....	31
7.5.8 Read Burst Terminate	31
7.5.9 Read to Write	32
7.5.10 Read to Pre-charge.....	32
7.5.11 Burst Terminate of Read.....	33
7.6 Write.....	33
7.6.1 Write Command	34
7.6.2 Basic Write Timing Parameters.....	34
7.6.3 Write Burst (min. and max. tDQSS)	35
7.6.4 Write to Write.....	35
7.6.5 Concatenated Write Bursts	36
7.6.6 Non-Consecutive Write Bursts	36
7.6.7 Random Write Cycles	37
7.6.8 Write to Read	37
7.6.9 Non-Interrupting Write to Read	37
7.6.10 Interrupting Write to Read.....	38
7.6.11 Write to Precharge	38
7.6.12 Non-Interrupting Write to Precharge	38
7.6.13 Interrupting Write to Precharge	39
7.7 Precharge.....	39
7.7.1 Precharge Command	40
7.8 Auto Precharge	40
7.9 Refresh Requirements.....	40
7.10 Auto Refresh	40
7.10.1 Auto Refresh Command.....	41
7.11 Self Referesh.....	41
7.11.1 Self Refresh Command.....	42
7.11.2 Auto Refresh Cycles Back-to-Back.....	42
7.11.3 Self Refresh Entry and Exit	43
7.12 Power Down	43
7.12.1 Power-Down Entry and Exit	43
7.13 Deep Power Down.....	44



7.13.1 Deep Power-Down Entry and Exit.....	44
7.14 Clock Stop.....	45
7.14.1 Clock Stop Mode Entry and Exit	45
8. ELECTRICAL CHARACTERISTIC	46
8.1 Absolute Maximum Ratings	46
8.2 Input/Output Capacitance	46
8.3 Electrical Characteristics and AC/DC Operating Conditions	47
8.3.1 Electrical Characteristics and AC/DC Operating Conditions	47
8.4 IDD Specification Parameters and Test Conditions	48
8.4.1 IDD Specification Parameters and Test Conditions.....	48
8.5 AC Timings.....	51
8.5.1 CAS Latency Definition (With CL=3).....	54
8.5.2 Output Slew Rate Characteristics	55
8.5.3 AC Overshoot/Undershoot Specification	55
8.5.4 AC Overshoot and Undershoot Definition.....	55
9. PACKAGE DIMENSIONS	56
9.1: LPDDR X 16.....	56
9.2: LPDDR X 32.....	57
10. ORDERING INFORMATION	58
11. REVISION HISTORY	59



1. GENERAL DESCRIPTION

W947D6HB / W947D2HB is a high-speed Low Power double data rate synchronous dynamic random access memory (LPDDR SDRAM). An access to the LPDDR SDRAM is burst oriented. Consecutive memory location in one page can be accessed at a burst length of 2, 4, 8 and 16 when a bank and row is selected by an ACTIVE command. Column addresses are automatically generated by the LPDDR SDRAM internal counter in burst operation. Random column read is also possible by providing its address at each clock cycle. The multiple bank nature enables interleaving among internal banks to hide the pre-charging time. By setting programmable Mode Registers, the system can change burst length, latency cycle, interleave or sequential burst to maximize its performance. The device supports special low power functions such as Partial Array Self Refresh (PASR) and Automatic Temperature Compensated Self Refresh (ATCSR).

2. FEATURES

- | | |
|---|---|
| <ul style="list-style-type: none"> • VDD = 1.7~1.95V • VDDQ = 1.7~1.95V; • Data width: x16 / x32 • Clock rate: 200MHz(-5),166MHz(-6),133MHz(-75) • Partial Array Self-Refresh(PASR) • Auto Temperature Compensated Self-Refresh(ATCSR) • Power Down Mode • Deep Power Down Mode (DPD Mode) • Programmable output buffer driver strength • Four internal banks for concurrent operation • Data mask (DM) for write data • Clock Stop capability during idle periods • Auto Pre-charge option for each burst access • Double data rate for data output • Differential clock inputs (CK and \overline{CK}) • Bidirectional, data strobe (DQS) | <ul style="list-style-type: none"> • \overline{CAS} Latency: 2 and 3 • Burst Length: 2, 4, 8 and 16 • Burst Type: Sequential or Interleave • 64 ms Refresh period • Interface: LVCMOS compatible • Support package: <ul style="list-style-type: none"> 60 balls BGA (x16) 90 balls BGA (x32) • Operating Temperature Range : <ul style="list-style-type: none"> Extended (-25°C ~ +85°C) Industrial (-40°C ~ +85°C) |
|---|---|



3. PIN CONFIGURATION

3.1 Ball Assignment: LPDDR X16

60 BALL VFBGA									
	1	2	3	4	5	6	7	8	9
A	VSS	DQ15	VSSQ				VDDQ	DQ0	VDD
B	VDDQ	DQ13	DQ14				DQ1	DQ2	VSSQ
C	VSSQ	DQ11	DQ12				DQ3	DQ4	VDDQ
D	VDDQ	DQ9	DQ10				DQ5	DQ6	VSSQ
E	VSSQ	UDQS	DQ8				DQ7	LDQS	VDDQ
F	VSS	UDM	NC				NC	LDM	VDD
G	CKE	CK	\overline{CK}				\overline{WE}	\overline{CAS}	\overline{RAS}
H	A9	A11	NC				\overline{CS}	BA0	BA1
J	A6	A7	A8				A10/AP	A0	A1
K	VSS	A4	A5				A2	A3	VDD

(Top View) Pin Configuration

3.2 Ball Assignment: LPDDR X32

90 BALL VFBGA									
	1	2	3	4	5	6	7	8	9
A	VSS	DQ31	VSSQ				VDDQ	DQ16	VDD
B	VDDQ	DQ29	DQ30				DQ17	DQ18	VSSQ
C	VSSQ	DQ27	DQ28				DQ19	DQ20	VDDQ
D	VDDQ	DQ25	DQ26				DQ21	DQ22	VSSQ
E	VSSQ	DQS3	DQ24				DQ23	DQS2	VDDQ
F	VDD	DM3	NC				NC	DM2	VSS
G	CKE	CK	\overline{CK}				\overline{WE}	\overline{CAS}	\overline{RAS}
H	A9	A11	NC				\overline{CS}	BA0	BA1
J	A6	A7	A8				A10/AP	A0	A1
K	A4	DM1	A5				A2	DM0	A3
L	VSSQ	DQS1	DQ8				DQ7	DQS0	VDDQ
M	VDDQ	DQ9	DQ10				DQ5	DQ6	VSSQ
N	VSSQ	DQ11	DQ12				DQ3	DQ4	VDDQ
P	VDDQ	DQ13	DQ14				DQ1	DQ2	VSSQ
R	VSS	DQ15	VSSQ				VDDQ	DQ0	VDD

(Top View) Pin Configuration



4. PIN DESCRIPTION

4.1 Signal Descriptions

SIGNAL NAME	TYPE	FUNCTION	DESCRIPTION
A [n : 0]	Input	Address	Provide the row address for ACTIVE commands, and the column address and AUTO PRECHARGE bit for READ/WRITE commands, to select one location out of the memory array in the respective bank. The address inputs also provide the opcode during a MODE REGISTER SET command. A10 is used for Auto Pre-charge Select.
BA0, BA1	Input	Bank Select	Define to which bank an ACTIVE, READ, WRITE or PRECHARGE command is being applied.
DQ0~DQ15 (x16) DQ0~DQ31 (x32)	I/O	Data Input/ Output	Data bus: Input / Output.
$\overline{\text{CS}}$	Input	Chip Select	$\overline{\text{CS}}$ enables (registered LOW) and disables (registered HIGH) the command decoder. All commands are masked when $\overline{\text{CS}}$ is registered HIGH. $\overline{\text{CS}}$ provides for external bank selection on systems with multiple banks. $\overline{\text{CS}}$ is considered part of the command code.
$\overline{\text{RAS}}$	Input	Row Address Strobe	$\overline{\text{RAS}}$, $\overline{\text{CAS}}$ and $\overline{\text{WE}}$ (along with $\overline{\text{CS}}$) define the command being entered.
$\overline{\text{CAS}}$	Input	Column Address Strobe	Referred to $\overline{\text{RAS}}$
$\overline{\text{WE}}$	Input	Write Enable	Referred to $\overline{\text{RAS}}$
UDM / LDM(x16); DM0 to DM3 (x32)	Input	Input Mask	Input Data Mask: DM is an input mask signal for write data. Input data is masked when DM is sampled HIGH along with that input data during a WRITE access. DM is sampled on both edges of DQS. Although DM pins are input-only, the DM loading matches the DQ and DQS loading. x16: LDM: DQ0 - DQ7, UDM: DQ8 - DQ15 x32: DM0: DQ0 - DQ7, DM1: DQ8 - DQ15, DM2: DQ16 - DQ23, DM3: DQ24 - DQ31
CK / $\overline{\text{CK}}$	Input	Clock Inputs	CK and $\overline{\text{CK}}$ are differential clock inputs. All address and control input signals are sampled on the crossing of the positive edge of CK and negative edge of $\overline{\text{CK}}$. Input and output data is referenced to the crossing of CK and $\overline{\text{CK}}$ (both directions of crossing). Internal clock signals are derived from CK/ $\overline{\text{CK}}$.



SIGNAL NAME	TYPE	FUNCTION	DESCRIPTION
CKE	Input	Clock Enable	CKE HIGH activates, and CKE LOW deactivates internal clock signals, and device input buffers and output drivers. Taking CKE LOW provides PRECHARGE, POWER DOWN and SELF REFRESH operation (all banks idle), or ACTIVE POWER DOWN (row ACTIVE in any bank). CKE is synchronous for all functions except for SELF REFRESH EXIT, which is achieved asynchronously. Input buffers, excluding CK, $\overline{\text{CK}}$ and CKE, are disabled during power down and self refresh mode which are contrived for low standby power consumption.
LDQS, UDQS (x16); DQS0~DQS3 (x32)	I/O	Data Strobe	Output with read data, input with write data. Edge-aligned with read data, centered with write data. Used to capture write data. x16: LDQS: DQ0~DQ7; UDQS: DQ8~DQ15. x32: DQS0: DQ0~DQ7; DQS1: DQ8~DQ15; DQS2: DQ16~DQ23; DQS3: DQ24~DQ31.
VDD	Supply	Power	Power supply for input buffers and internal circuit.
VSS	Supply	Ground	Ground for input buffers and internal circuit.
VDDQ	Supply	Power for I/O Buffer	Power supply separated from VDD, used for output drivers to improve noise.
VSSQ	Supply	Ground for I/O Buffer	Ground for output drivers.
NC	-	No Connect	Non connection pin.

4.2 Addressing Table

ITEM		128Mb
Number of banks		4
Bank address pins		BA0,BA1
Auto precharge pin		A10/AP
X16	Row addresses	A0-A11
	Column addresses	A0-A8
	tREFI (μs)	15.6
x32	Row addresses	A0-A11
	Column addresses	A0-A7
	tREFI (μs)	15.6



5. BLOCK DIAGRAM

5.1 Block Diagram





5.2 Simplified State Diagram





6. FUNCTION DESCRIPTION

6.1 Initialization

LPDDR SDRAM must be powered up and initialized in a predefined manner. Operations procedures other than those specified may result in undefined operation. If there is any interruption to the device power, the initialization routine should be followed. The steps to be followed for device initialization are listed below.

The Mode Register and Extended Mode Register do not have default values. If they are not programmed during the initialization sequence, it may lead to unspecified operation. The clock stop feature is not available until the device has been properly initialized from Step 1 through 11.

- Step 1: Provide power, the device core power (VDD) and the device I/O power (VDDQ) must be brought up simultaneously to prevent device latch-up. Although not required, it is recommended that VDD and VDDQ are from the same power source. Also Assert and hold Clock Enable (CKE) to a LVCMOS logic high level
- Step 2: Once the system has established consistent device power and CKE is driven high, it is safe to apply stable clock.
- Step 3: There must be at least 200 μ s of valid clocks before any command may be given to the DRAM. During this time NOP or DESELECT commands must be issued on the command bus.
- Step 4: Issue a PRECHARGE ALL command.
- Step 5: Provide NOPs or DESELECT commands for at least tRP time.
- Step 6: Issue an AUTO REFRESH command followed by NOPs or DESELECT command for at least tRFC time. Issue the second AUTO REFRESH command followed by NOPs or DESELECT command for at least tRFC time. Note as part of the initialization sequence there must be two Auto Refresh commands issued. The typical flow is to issue them at Step 6, but they may also be issued between steps 10 and 11.
- Step 7: Using the MRS command, program the base mode register. Set the desired operation modes.
- Step 8: Provide NOPs or DESELECT commands for at least tMRD time.
- Step 9: Using the MRS command, program the extended mode register for the desired operating modes. Note the order of the base and extended mode register programmed is not important.
- Step 10: Provide NOP or DESELECT commands for at least tMRD time.
- Step 11: The DRAM has been properly initialized and is ready for any valid command.

6.1.1 Initialization Flow Diagram



6.1.2 Initialization Waveform Sequence



6.2 Register Definition

6.2.1 Mode Register Set Operation

The Mode Register is used to define the specific mode of operation of the LPDDR SDRAM. This definition includes the definition of a burst length, a burst type, a CAS latency as shown in the following figure.

The Mode Register is programmed via the MODE REGISTER SET command (with BA0=0 and BA1=0) and will retain the stored information until it is reprogrammed, the device goes into Deep Power Down mode, or the device loses power.

Mode Register bits A0-A2 specify the burst length, A3 the type of burst (sequential or interleave), A4-A6 the CAS latency. A logic 0 should be programmed to all the undefined addresses bits to ensure future compatibility.

The Mode Register must be loaded when all banks are idle and no bursts are in progress, and the controller must wait the specified time t_{MRD} before initiating any subsequent operation. Violating either of these requirements will result in unspecified operation.

Reserved states should not be used, as unknown operation or incompatibility with future versions may result.



6.2.2 Mode Register Definition



6.2.3. Burst Length

Read and write accesses to the LPDDR SDRAM are burst oriented, with the burst length and burst type being programmable.

The burst length determines the maximum number of column locations that can be accessed for a given READ or WRITE command. Burst lengths of 2, 4, or 8 locations are available for both the sequential and the interleaved burst types.

When a READ or WRITE command is issued, a block of columns equal to the burst length is effectively selected. All accesses for that burst take place within the block, meaning that the burst will wrap within the block if a boundary is reached.

The block is uniquely selected by A1–An when the burst length is set to two, by A2–An when the burst length is set to 4, by A3–An when the burst length is set to 8 (where An is the most significant column address bit for a given configuration). The remaining (least significant) address bit(s) is (are) used to select the starting location within the block. The programmed burst length applies to both read and write bursts.



6.3 Burst Definition

BURST LENGTH	STARTING COLUMN ADDRESS				ORDER OF ACCESSES WITHIN A BURST (HEXADECIMAL NOTATION)		
	A3	A2	A1	A0	SEQUENTIAL	INTERLEAVED	
2					0	0-1	0-1
					1	1-0	1-0
4					0 0	0-1-2-3	0-1-2-3
					0 1	1-2-3-0	1-0-3-2
					1 0	2-3-0-1	2-3-0-1
					1 1	3-0-1-2	3-2-1-0
8					0 0 0	0-1-2-3-4-5-6-7	0-1-2-3-4-5-6-7
					0 0 1	1-2-3-4-5-6-7-0	1-0-3-2-5-4-7-6
					0 1 0	2-3-4-5-6-7-0-1	2-3-0-1-6-7-4-5
					0 1 1	3-4-5-6-7-0-1-2	3-2-1-0-7-6-5-4
					1 0 0	4-5-6-7-0-1-2-3	4-5-6-7-0-1-2-3
					1 0 1	5-6-7-0-1-2-3-4	5-4-7-6-1-0-3-2
					1 1 0	6-7-0-1-2-3-4-5	6-7-4-5-2-3-0-1
					1 1 1	7-0-1-2-3-4-5-6	7-6-5-4-3-2-1-0
16	0	0	0	0	0-1-2-3-4-5-6-7-8-9-A-B-C-D-E-F	0-1-2-3-4-5-6-7-8-9-A-B-C-D-E-F	
	0	0	0	1	1-2-3-4-5-6-7-8-9-A-B-C-D-E-F-0	1-0-3-2-5-4-7-6-9-8-B-A-D-C-F-E	
	0	0	1	0	2-3-4-5-6-7-8-9-A-B-C-D-E-F-0-1	2-3-0-1-6-7-4-5-A-B-8-9-E-F-C-D	
	0	0	1	1	3-4-5-6-7-8-9-A-B-C-D-E-F-0-1-2	3-2-1-0-7-6-5-4-B-A-9-8-F-E-D-C	
	0	1	0	0	4-5-6-7-8-9-A-B-C-D-E-F-0-1-2-3	4-5-6-7-0-1-2-3-C-D-E-F-8-9-A-B	
	0	1	0	1	5-6-7-8-9-A-B-C-D-E-F-0-1-2-3-4	5-4-7-6-1-0-3-2-D-C-F-E-9-8-B-A	
	0	1	1	0	6-7-8-9-A-B-C-D-E-F-0-1-2-3-4-5	6-7-4-5-2-3-0-1-E-F-C-D-A-B-8-9	
	0	1	1	1	7-8-9-A-B-C-D-E-F-0-1-2-3-4-5-6	7-6-5-4-3-2-1-0-F-E-D-C-B-A-9-8	
	1	0	0	0	8-9-A-B-C-D-E-F-0-1-2-3-4-5-6-7	8-9-A-B-C-D-E-F-0-1-2-3-4-5-6-7	
	1	0	0	1	9-A-B-C-D-E-F-0-1-2-3-4-5-6-7-8	9-8-B-A-D-C-F-E-1-0-3-2-5-4-7-6	
	1	0	1	0	A-B-C-D-E-F-0-1-2-3-4-5-6-7-8-9	A-B-8-9-E-F-C-D-2-3-0-1-6-7-4-5	
	1	0	1	1	B-C-D-E-F-0-1-2-3-4-5-6-7-8-9-A	B-A-9-8-F-E-D-C-3-2-1-0-7-6-5-4	
	1	1	0	0	C-D-E-F-0-1-2-3-4-5-6-7-8-9-A-B	C-D-E-F-8-9-A-B-4-5-6-7-0-1-2-3	
	1	1	0	1	D-E-F-0-1-2-3-4-5-6-7-8-9-A-B-C	D-C-F-E-9-8-B-A-5-4-7-6-1-0-3-2	
1	1	1	0	E-F-0-1-2-3-4-5-6-7-8-9-A-B-C-D	E-F-C-D-A-B-8-9-6-7-4-5-2-3-0-1		
1	1	1	1	F-0-1-2-3-4-5-6-7-8-9-A-B-C-D-E	F-E-D-C-B-A-9-8-7-6-5-4-3-2-1-0		



Notes:

1. For a burst length of two, A1-An selects the two data element block; A0 selects the first access within the block.
2. For a burst length of four, A2-An selects the four data element block; A0-A1 selects the first access within the block.
3. For a burst length of eight, A3-An selects the eight data element block; A0-A2 selects the first access within the block.
4. For the optional burst length of sixteen, A4-An selects the sixteen data element block; A0-A3 selects the first access within the block.

5. Whenever a boundary of the block is reached within a given sequence, the following access wraps within the block.

When a READ or WRITE command is issued, a block of columns equal to the burst length is effectively selected. All accesses for that burst take place within the block, meaning that the burst will wrap within the block if a boundary is reached.

The block is uniquely selected by A1-An when the burst length is set to two, by A2-An when the burst length is set to 4, by A3-An when the burst length is set to 8 and A4-An when the burst length is set to 16 (where An is the most significant column address bit for a given configuration). The remaining (least significant) address bit(s) is (are) used to select the starting location within the block. The programmed burst length applies to both read and write bursts.

6.4 Burst Type

Accesses within a given burst may be programmed to be either sequential or interleaved; this is referred to as the burst type and is selected via bit A3. The ordering of accesses within a burst is determined by the burst length, the burst type and the starting column address, as shown in the previous table.

6.5 Read Latency

The READ latency is the delay between the registration of a READ command and the availability of the first piece of output data. The latency should be set to 2 or 3 clocks.

If a READ command is registered at a clock edge n and the latency is 3 clocks, the first data element will be valid at $n + 2 \text{ tCK} + \text{tAC}$. If a READ command is registered at a clock edge n and the latency is 2 clocks, the first data element will be valid at $n + \text{tCK} + \text{tAC}$.

6.6 Extended Mode Register Description

The Extended Mode Register controls functions beyond those controlled by the Mode Register; these additional functions include output drive strength selection and Partial Array Self Refresh (PASR). PASR is effective in Self Refresh mode only.

The Extended Mode Register is programmed via the MODE REGISTER SET command (with BA1=1 and BA0=0) and will retain the stored information until it is reprogrammed, the device is put in Deep Power Down mode, or the device loses power.

The Extended Mode Register must be loaded when all banks are idle and no bursts are in progress, and the controller must wait the specified time tMRD before initiating any subsequent operation. Violating either of these requirements will result in unspecified operation.

Address bits A0-A2 specify PASR, A5-A7 the Driver Strength. A logic 0 should be programmed to all the undefined addresses bits to ensure future compatibility.

Reserved states should not be used, as unknown operation or incompatibility with future versions may result.

6.6.1 Extended Mode Register Definition



6.7 Status Register Read

Status Register Read (SRR) is an optional feature in JEDEC, and it is implemented in this device. With SRR, a method is defined to read registers from the device. The encoding for an SRR command is the same as a MRS with BA[1:0]="01". The address pins (A[n:0]) encode which register is to be read. Currently only one register is defined at A[n:0]=0. The sequence to perform an SRR command is as follows:

- All reads/writes must be completed
- All banks must be closed
- MRS with BA=01 is issued (SRR)
- Wait tSRR
- Read issued to any bank/page
- CAS latency cycles later the device returns the registers data as it would a normal read
- The next command to the device can be issued tSRC after the Read command was issued.

The burst length for the SRR read is always fixed to length 2.



6.7.1 SRR Register (A[n:0] = 0)





6.7.2 Status Register Read Timing Diagram



Notes :

1. SRR can only be issued after power-up sequence is complete.
2. SRR can only be issued with all banks precharged.
3. SRR CL is unchanged from value in the mode register.
4. SRR BL is fixed at 2.
5. $t_{SRR} = 2$ (min).
6. $t_{SRC} = CL + 1$; (min time between read to next valid command)
7. No commands other than NOP and DES are allowed between the SRR and the READ.



6.8 Partial Array Self Refresh

With partial array self refresh (PASR), the self refresh may be restricted to a variable portion of the total array. The whole array (default), 1/2 array, or 1/4 array could be selected. Data outside the defined area will be lost. Address bits A0 to A2 are used to set PASR.

6.9 Automatic Temperature Compensated Self Refresh

The device has an Automatic Temperature Compensated Self Refresh feature. It automatically adjusts the refresh rate based on the device temperature without any register update needed. To maintain backward compatibility, this device which have Automatic TCSR, ignore (don't care) the inputs to address bits A3 and A4 during EMRS programming.

6.10 Output Drive Strength

The drive strength could be set to full, half or three-quarter strength via address bits A5 and A6. The half drive strength option is intended for lighter loads or point-to-point environments.

6.11 Commands

All commands (address and control signals) are registered on the positive edge of clock (crossing of CK going high and \overline{CK} going low).

6.11.1 Basic Timing Parameters for Commands





6.11.2 Truth Table - Commands

NAME (FUNCTION)	$\overline{\text{CS}}$	$\overline{\text{RAS}}$	$\overline{\text{CAS}}$	$\overline{\text{WE}}$	BA	A10/AP	ADDR	NOTES
DESELECT (NOP)	H	X	X	X	X	X	X	2
NO OPERATION (NOP)	L	H	H	H	X	X	X	2
ACTIVE (Select Bank and activate row)	L	L	H	H	Valid	Row	Row	
READ (Select bank and column and start read burst)	L	H	L	H	Valid	L	Col	
READ with AP (Read Burst with Auto Precharge)	L	H	L	H	Valid	H	Col	3
WRITE (Select bank and column and start write burst)	L	H	L	L	Valid	L	Col	
WRITE with AP (Write Burst with Auto Precharge)	L	H	L	L	Valid	H	Col	3
BURST TERMINATE or enter DEEP POWER DOWN	L	H	H	L	X	X	X	4, 5
PRECHARGE (Deactivate Row in selected bank)	L	L	H	L	Valid	L	X	6
PRECHARGE ALL (Deactivate rows in all banks)	L	L	H	L	X	H	X	6
AUTO REFRESH or enter SELF REFRESH	L	L	L	H	X	X	X	7, 8, 9
MODE REGISTER SET	L	L	L	L	Valid	Op-code		10

Notes:

1. All states and sequences not shown are illegal or reserved.
2. Deselect and NOP are functionally interchangeable.
3. Auto precharge is non-persistent. A10 High enables Auto precharge, while A10 Low disables Auto precharge.
4. Burst Terminate applies to only Read bursts with Autoprecharge disabled. This command is undefined and should not be used for Read with Auto precharge enabled, and for Write bursts.
5. This command is BURST TERMINATE if CKE is High and DEEP POWER DOWN entry if CKE is Low.
6. If A10 is low, bank address determines which bank is to be precharged. If A10 is high, all banks are precharged and BA0~BA1 are don't care.
7. This command is AUTO REFRESH if CKE is High and SELF REFRESH if CKE is low.
8. All address inputs and I/O are 'don't care' except for CKE. Internal refresh counters control bank and row addressing.
9. All banks must be precharged before issuing an AUTO-REFRESH or SELF REFRESH command.
10. BA0 and BA1 value select between MRS and EMRS.
11. CKE is HIGH for all commands shown except SELF REFRESH and DEEP POWER-DOWN.



6.11.3 Truth Table - DM Operations

FUNCTION	DM	DQ	NOTES
Write Enable	L	Valid	1
Write Inhibit	H	X	1

Notes:

- Used to mask write data, provided coincident with the corresponding data.

6.11.4 Truth Table - CKE

CKEn-1	CKEn	CURRENT STATE	COMMANDn	ACTIONn	NOTES
L	L	Power Down	X	Maintain Power Down	
L	L	Self Refresh	X	Maintain Self Refresh	
L	L	Deep Power Down	X	Maintain Deep Power Down	
L	H	Power Down	NOP or DESELECT	Exit Power Down	5, 6, 9
L	H	Self Refresh	NOP or DESELECT	Exit Self Refresh	5, 7, 10
L	H	Deep Power Down	NOP or DESELECT	Exit Deep Power Down	5, 8
H	L	All Banks Idle	NOP or DESELECT	Precharge Power Down Entry	5
H	L	Bank(s) Active	NOP or DESELECT	Active Power Down Entry	5
H	L	All Banks Idle	AUTO REFRESH	Self Refresh Entry	
H	L	All Banks Idle	BURST TERMINATE	Enter Deep Power Down	
H	H	See the other Truth Tables			

Notes:

- CKEn is the logic state of CKE at clock edge n; CKEn-1 was the state of CKE at the previous clock edge.
- Current state is the state of LPDDR immediately prior to clock edge n.
- COMMANDn is the command registered at clock edge n, and ACTIONn is the result of COMMANDn.
- All states and sequences not shown are illegal or reserved.
- DESELECT and NOP are functionally interchangeable.
- Power Down exit time (tXP) should elapse before a command other than NOP or DESELECT is issued.
- SELF REFRESH exit time (tXSR) should elapse before a command other than NOP or DESELECT is issued.
- The Deep Power-Down exit procedure must be followed as discussed in the Deep Power-Down section of the Functional Description.
- The clock must toggle at least once during the tXP period.
- The clock must toggle at least once during the tXSR time.



6.11.5 Truth Table - Current State BANKn - Command to BANKn

CURRENT STATE	\overline{CS}	\overline{RAS}	\overline{CAS}	\overline{WE}	COMMAND	ACTION	NOTES
Any	H	X	X	X	DESELECT	NOP or Continue previous operation	
	L	H	H	H	No Operation	NOP or Continue previous operation	
Idle	L	L	H	H	ACTIVE	Select and activate row	
	L	L	L	H	AUTO REFRESH	Auto refresh	10
	L	L	L	L	MRS	Mode register set	10
Row Active	L	H	L	H	READ	Select column & start read burst	
	L	H	L	L	WRITE	Select column & start write burst	
	L	L	H	L	PRECHARGE	Deactivate row in bank (or banks)	4
Read (Auto precharge Disabled)	L	H	L	H	READ	Select column & start new read burst	5, 6
	L	H	L	L	WRITE	Select column & start write burst	5, 6, 13
	L	L	H	L	PRECHARGE	Truncate read burst, start precharge	
	L	H	H	L	BURST TERMINATE	Burst terminate	11
Write (Auto precharge Disabled)	L	H	L	H	READ	Select column & start read burst	5, 6, 12
	L	H	L	L	WRITE	Select column & start new write burst	5, 6
	L	L	H	L	PRECHARGE	Truncate write burst & start precharge	12

Notes:

- The table applies when both CKEn-1 and CKEn are HIGH, and after tXSR or tXP has been met if the previous state was Self Refresh or Power Down.
- DESELECT and NOP are functionally interchangeable.
- All states and sequences not shown are illegal or reserved.
- This command may or may not be bank specific. If all banks are being precharged, they must be in a valid state for precharging.
- A command other than NOP should not be issued to the same bank while a READ or WRITE burst with Auto Precharge is enabled.
- The new Read or Write command could be Auto Precharge enabled or Auto Precharge disabled.
- Current State Definitions:
 Idle: The bank has been precharged, and tRP has been met.
 Row Active: A row in the bank has been activated, and tRCD has been met. No data bursts/accesses and no register accesses are in progress.
 Read: A READ burst has been initiated, with Auto Precharge disabled, and has not yet terminated or been terminated.
 Write: A WRITE burst has been initiated, with Auto Precharge disabled, and has not yet terminated or been terminated.
- The following states must not be interrupted by a command issued to the same bank. DESELECT or NOP commands or allowable commands to the other bank should be issued on any clock edge occurring during these states. Allowable commands to the other bank are determined by its current state and this table, and according to next table.
 Precharging: Starts with the registration of a PRECHARGE command and ends when tRP is met. Once tRP is met, the bank will be in the idle state.
 Row Activating: Starts with registration of an ACTIVE command and ends when tRCD is met. Once tRCD is met, the bank will be in the 'row active' state.
 Read with AP Enabled: Starts with the registration of the READ command with Auto Precharge enabled and ends when tRP has been met. Once tRP has been met, the bank will be in the idle state.
 Write with AP Enabled: Starts with registration of a WRITE command with Auto Precharge enabled and ends when tRP has been met. Once tRP is met, the bank will be in the idle state.
- The following states must not be interrupted by any executable command; DESELECT or NOP commands must be applied to each positive clock edge during these states.
 Refreshing: Starts with registration of an AUTO REFRESH command and ends when tRFC is met. Once tRFC is met, the LPDDR will be in an 'all banks idle' state.



128Mb Mobile LPDDR

Accessing Mode Register: Starts with registration of a MODE REGISTER SET command and ends when tMRD has been met. Once tMRD is met, the LPDDR will be in an 'all banks idle' state.

Precharging All: Starts with the registration of a PRECHARGE ALL command and ends when tRP is met. Once tRP is met, the bank will be in the idle state.

10. Not bank-specific; requires that all banks are idle and no bursts are in progress.
11. Not bank-specific. BURST TERMINATE affects the most recent READ burst, regardless of bank.
12. Requires appropriate DM masking.
13. A WRITE command may be applied after the completion of the READ burst; otherwise, a BURST TERMINATE must be used to end the READ prior to asserting a WRITE command.

6.11.6 Truth Table - Current State BANKn, Command to BANKn

CURRENT STATE	\overline{CS}	\overline{RAS}	\overline{CAS}	\overline{WE}	COMMAND	ACTION	NOTES
Any	H	X	X	X	DESELECT	NOP or Continue previous Operation	
	L	H	H	H	NOP	NOP or Continue previous Operation	
Idle	X	X	X	X	ANY	Any command allowed to bank m	
Row Activating, Active, or Precharging	L	L	H	H	ACTIVE	Select and activate row	
	L	H	L	H	READ	Select column & start read burst	8
	L	H	L	L	WRITE	Select column & start write burst	8
	L	L	H	L	PRECHARGE	Precharge	
Read with Auto Precharge disabled	L	L	H	H	ACTIVE	Select and activate row	
	L	H	L	H	READ	Select column & start new read burst	8
	L	H	L	L	WRITE	Select column & start write burst	8,10
	L	L	H	L	PRECHARGE	Precharge	
Write with Auto Precharge disabled	L	L	H	H	ACTIVE	Select and activate row	
	L	H	L	H	READ	Select column & start read burst	8, 9
	L	H	L	L	WRITE	Select column & start new write burst	8
	L	L	H	L	PRECHARGE	Precharge	
Read with Auto Precharge	L	L	H	H	ACTIVE	Select and activate row	
	L	H	L	H	READ	Select column & start new read burst	5, 8
	L	H	L	L	WRITE	Select column & start write burst	5, 8, 10
	L	L	H	L	PRECHARGE	Precharge	
Write with Auto Precharge	L	L	H	H	ACTIVE	Select and activate row	
	L	H	L	H	READ	Select column & start read burst	5, 8
	L	H	L	L	WRITE	Select column & start new write burst	5, 8
	L	L	H	L	PRECHARGE	Precharge	



Notes:

1. The table applies when both CKEn-1 and CKEn are HIGH, and after tXSR or tXP has been met if the previous state was Self Refresh or Power Down.
2. DESELECT and NOP are functionally interchangeable.
3. All states and sequences not shown are illegal or reserved.
4. Current State Definitions:
 Idle: The bank has been precharged, and tRP has been met.
 Row Active: A row in the bank has been activated, and tRCD has been met. No data bursts/accesses and no register accesses are in progress.
 Read: A READ burst has been initiated, with Auto Precharge disabled, and has not yet terminated or been terminated.
 Write: A Write burst has been initiated, with Auto Precharge disabled, and has not yet terminated or been terminated.
5. Read with AP enabled and Write with AP enabled: The read with Auto Precharge enabled or Write with Auto Precharge enabled states can be broken into two parts: the access period and the precharge period. For Read with AP, the precharge period is defined as if the same burst was executed with Auto Precharge disabled and then followed with the earliest possible PRECHARGE command that still accesses all the data in the burst. For Write with Auto precharge, the precharge period begins when tWR ends, with tWR measured as if Auto Precharge was disabled. The access period starts with registration of the command and ends where the precharge period (or tRP) begins. During the precharge period, of the Read with Auto Precharge enabled or Write with Auto Precharge enabled states, ACTIVE, PRECHARGE, READ, and WRITE commands to the other bank may be applied; during the access period, only ACTIVE and PRECHARGE commands to the other banks may be applied. In either case, all other related limitations apply (e.g. contention between READ data and WRITE data must be avoided).
6. AUTO REFRESH, SELF REFRESH, and MODE REGISTER SET commands may only be issued when all bank are idle.
7. A BURST TERMINATE command cannot be issued to another bank; it applies to the bank represented by the current state only.
8. READs or WRITEs listed in the Command column include READs and WRITEs with Auto Precharge enabled and READs and WRITEs with Auto Precharge disabled.
9. Requires appropriate DM masking.
10. A WRITE command may be applied after the completion of data output, otherwise a BURST TERMINATE command must be issued to end the READ prior to asserting a WRITE command.

7. OPERATION

7.1. Deselect

The DESELECT function (\overline{CS} = high) prevents new commands from being executed by the LPDDR SDRAM. The LPDDR SDRAM is effectively deselected. Operations already in progress are not affected.

7.2. No Operation

The NO OPERATION (NOP) command is used to perform a NOP to a LPDDR SDRAM that is selected (\overline{CS} = Low). This prevents unwanted commands from being registered during idle or wait states. Operations already in progress are not affected.



7.2.1 NOP Command

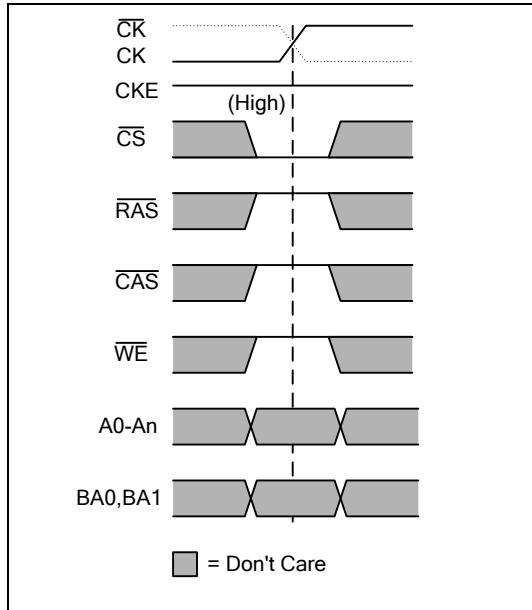

7.3 Mode Register Set

The Mode Register and the Extended Mode Register are loaded via the address inputs. The MODE REGISTER SET command can only be issued when all banks are idle and no bursts are in progress, and a subsequent executable command cannot be issued until tMRD is met.

7.3.1 Mode Register Set Command





7.3.2 Mode Register Set Command Timing



7.4. Active

Before any READ or WRITE commands can be issued to a bank in the LPDDR SDRAM, a row in that bank must be opened. This is accomplished by the ACTIVE command: BA0 and BA1 select the bank, and the address inputs select the row to be activated. More than one bank can be active at any time.

Once a row is open, a READ or WRITE command could be issued to that row, subject to the tRCD specification.

A subsequent ACTIVE command to another row in the same bank can only be issued after the previous row has been closed. The minimum time interval between two successive ACTIVE commands on the same bank is defined by tRC.

7.4.1 Active Command

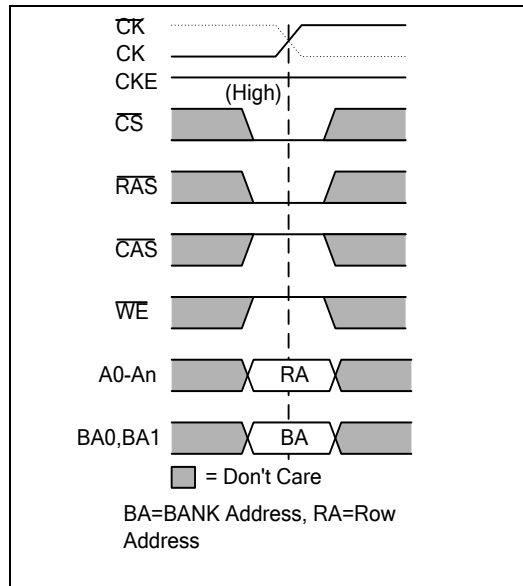



128Mb Mobile LPDDR

A subsequent ACTIVE command to another bank can be issued while the first bank is being accessed, which results in a reduction of total row-access overhead. The minimum time interval between two successive ACTIVE commands on different banks is defined by t_{RRD} .

The row remains active until a PRECHARGE command (or READ or WRITE command with Auto Precharge) is issued to the bank.

A PRECHARGE (or READ with Auto Precharge or Write with Auto Precharge) command must be issued before opening a different row in the same bank.

7.4.2 Bank Activation Command Cycle



7.5. Read

The READ command is used to initiate a burst read access to an active row, with a burst length as set in the Mode Register. BA0 and BA1 select the bank, and the address inputs select the starting column location. The value of A10 determines whether or not Auto Pre-charge is used. If Auto Pre-charge is selected, the row being accessed will be pre-charged at the end of the read burst; if Auto Pre-charge is not selected, the row will remain open for subsequent accesses.



7.5.1 Read Command



The basic Read timing parameters for DQs are shown in following figure; they apply to all Read operations.

7.5.2 Basic Read Timing Parameters

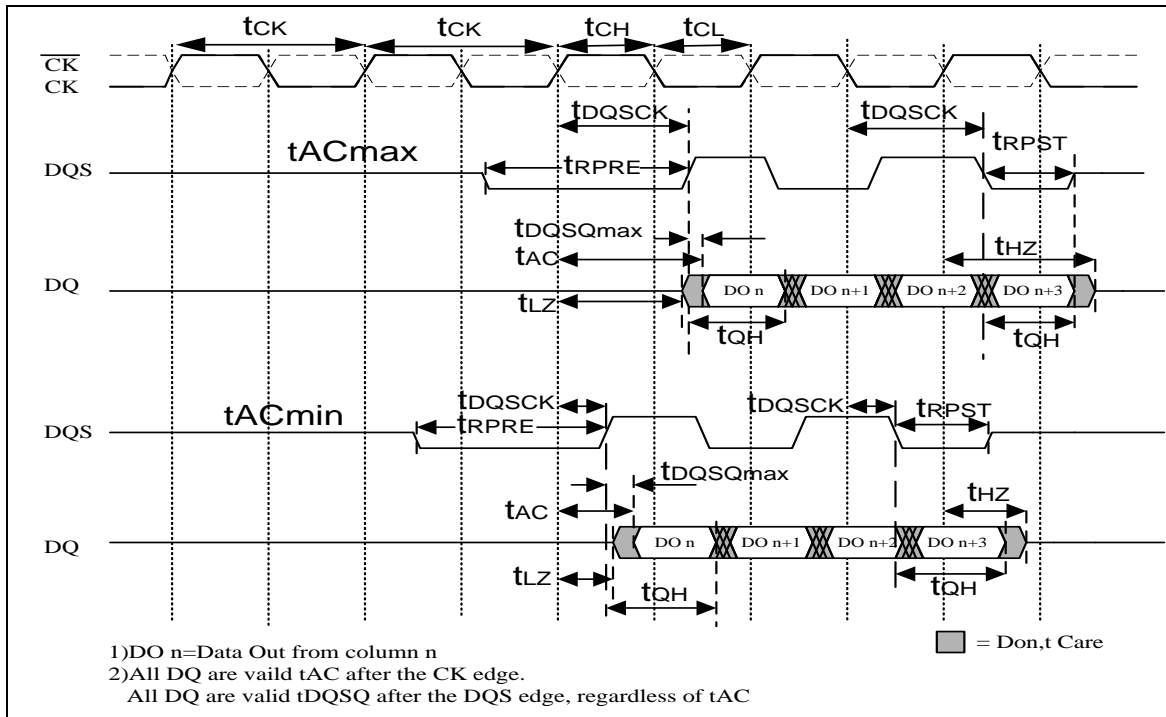



128Mb Mobile LPDDR

During Read bursts, DQS is driven by the LPDDR SDRAM along with the output data. The initial Low state of the DQS is known as the read preamble; the Low state coincident with last data-out element is known as the read postamble. The first data-out element is edge aligned with the first rising edge of DQS and the successive data-out elements are edge aligned to successive edges of DQS. This is shown in following figure with a CAS latency of 2 and 3.

Upon completion of a read burst, assuming no other READ command has been initiated, the DQs will go to High-Z.

7.5.3 Read Burst Showing CAS Latency



7.5.4 Read to Read

Data from a read burst may be concatenated or truncated by a subsequent READ command. The first data from the new burst follows either the last element of a completed burst or the last desired element of a longer burst that is being truncated. The new READ command should be issued X cycles after the first READ command, where X equals the number of desired data-out element pairs (pairs are required by the 2n-prefetch architecture). This is shown in following figure.



7.5.5 Consecutive Read Bursts



7.5.6 Non-Consecutive Read Bursts

A READ command can be initiated on any clock cycle following a previous READ command. Non-consecutive Reads are shown in following figure.





7.5.7 Random Read Bursts

Full-speed random read accesses within a page or pages can be performed as shown in following figure.



7.5.8 Read Burst Terminate

Data from any READ burst may be truncated with a BURST TERMINATE command, as shown in figure. The BURST TERMINATE latency is equal to the read (CAS) latency, i.e., the BURST TERMINATE command should be issued X cycles after the READ command where X equals the desired data-out element pairs.





7.5.9 Read to Write

Data from READ burst must be completed or truncated before a subsequent WRITE command can be issued. If truncation is necessary, the BURST TERMINATE command must be used, as shown in following figure for the case of nominal tDQSS



7.5.10 Read to Pre-charge

A Read burst may be followed by or truncated with a PRECHARGE command to the same bank (provided Auto Pre-charge was not activated). The PRECHARGE command should be issued X cycles after the READ command, where X equal the number of desired data-out element pairs. This is shown in following figure. Following the PRECHARGE command, a subsequent command to the same bank cannot be issued until tRP is met. Note that part of the row pre-charge time is hidden during the access of the last data-out elements.

In the case of a Read being executed to completion, a PRECHARGE command issued at the optimum time (as described above) provides the same operation that would result from Read burst with Auto Pre-charge enabled. The disadvantage of the PRECHARGE command is that it requires that the command and address buses be available at the appropriate time to issue the command. The advantage of the PRECHARGE command is that it can be used to truncate bursts.



7.5.11 Burst Terminate of Read

The BURST TERMINATE command is used to truncate read bursts (with Auto Pre-charge disabled). The most recently registered READ command prior to the BURST TERMINATE command will be truncated. Note that the BURST TERMINATE command is not bank specific.

This command should not be used to terminate write bursts.



7.6 Write

The WRITE command is used to initiate a burst write access to an active row, with a burst length as set in the Mode Register. BA0 and BA1 select the bank, and the address inputs select the starting column location. The value of A10 determines whether or not Auto Pre-charge is used. If Auto Pre-charge is selected, the row being accessed will be pre-charged at the end of the write burst; if Auto Pre-charge is not selected, the row will remain open for subsequent accesses.



7.6.1 Write Command

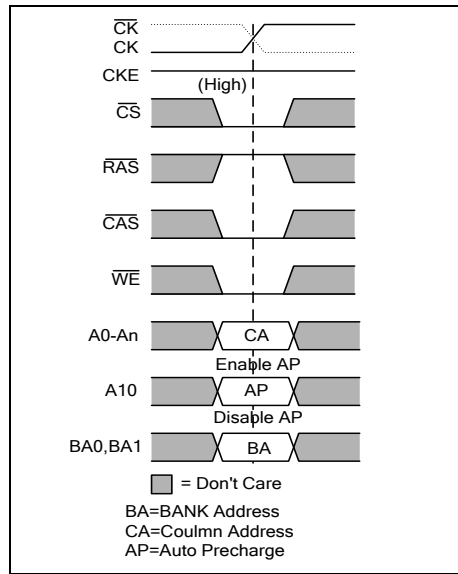

7.6.2 Basic Write Timing Parameters

Basic Write timing parameters for DQs are shown in figure below; they apply to all Write operations.

Input data appearing on the data bus, is written to the memory array subject to the DM input logic level appearing coincident with the data. If a given DM signal is registered Low, the corresponding data will be written to the memory; if the DM signal is registered High, the corresponding data inputs will be ignored, and a write will not be executed to that byte / column location.





7.6.3 Write Burst (min. and max. t_{DQSS})

During Write bursts, the first valid data-in element will be registered on the first rising edge of DQS following the WRITE command, and the subsequent data elements will be registered on successive edges of DQS. The Low state of DQS between the WRITE command and the first rising edge is called the write preamble, and the Low state on DQS following the last data-in element is called the write post-amble.

The time between the WRITE command and the first corresponding rising edge of DQS (t_{DQSS}) is specified with a relatively wide range - from 75% to 125% of a clock cycle. Following figure shows the two extremes of t_{DQSS} for a burst of 4, upon completion of a burst, assuming no other commands have been initiated, the DQs will remain high-Z and any additional input data will be ignored.



7.6.4 Write to Write

Data for any WRITE burst may be concatenated with or truncated with a subsequent WRITE command. In either case, a continuous flow of input data, can be maintained. The new WRITE command can be issued on any positive edge of the clock following the previous WRITE command.

The first data-in element from the new burst is applied after either the last element of a completed burst or the last desired data element of a longer burst which is being truncated. The new WRITE command should be issued X cycles after the first WRITE command, where X equals the number of desired data-in element pairs.



7.6.5 Concatenated Write Bursts

An example of concatenated write bursts is shown in figure below.



7.6.6 Non-Consecutive Write Bursts

An example of non-consecutive write bursts is shown in figure below.





7.6.7 Random Write Cycles

Full-speed random write accesses within a page or pages can be performed as shown in figure below.



7.6.8 Write to Read

Data for any Write burst may be followed by a subsequent READ command.

7.6.9 Non-Interrupting Write to Read

To follow a Write without truncating the write burst, t_{WTR} should be met as shown in the figure below.





7.6.10 Interrupting Write to Read

Data for any Write burst may be truncated by a subsequent READ command as shown in the figure below. Note that the only data-in pairs that are registered prior to the t_{WTR} period are written to the internal array, and any subsequent data-in must be masked with DM.



7.6.11 Write to Precharge

Data for any WRITE burst may be followed by a subsequent PRECHARGE command to the same bank (provided Auto Precharge was not activated). To follow a WRITE without truncating the WRITE burst, t_{WR} should be met as shown in the figure below.

7.6.12 Non-Interrupting Write to Precharge





7.6.13 Interrupting Write to Precharge

Data for any WRITE burst may be truncated by a subsequent PRECHARGE command as shown in figure below. Note that only data-in pairs that are registered prior to the t_{WR} period are written to the internal array, and any subsequent data-in should be masked with DM, as shown in figure. Following the PRECHARGE command, a subsequent command to the same bank cannot be issued until t_{RP} is met.



7.7 Precharge

The PRECHARGE command is used to deactivate the open row in a particular bank or the open row in all banks. The bank(s) will be available for a subsequent row access a specified time (t_{RP}) after the PRECHARGE command is issued.

Input A10 determines whether one or all banks are to be precharged. In case where only one bank is to be precharged, inputs BA0, BA1 select the bank. Otherwise BA0, BA1 are treated as "Don't Care".

Once a bank has been precharged, it is in the idle state and must be activated prior to any READ or WRITE command being issued. A PRECHARGE command will be treated as a NOP if there is no open row in that bank, or if the previously open row is already in the process of precharging.

7.7.1 Precharge Command



7.8 Auto Precharge

Auto Precharge is a feature which performs the same individual bank precharge function as described above, but without requiring an explicit command. This is accomplished by using A10 (A10 = High), to enable Auto Precharge in conjunction with a specific READ or WRITE command. A precharge of the bank / row that is addressed with the READ or WRITE command is automatically performed upon completion of the read or write burst. Auto Precharge is non persistent in that it is either enabled or disabled for each individual READ or WRITE command.

Auto Precharge ensures that a precharge is initiated at the earliest valid stage within a burst. The user must not issue another command to the same bank until the precharging time (t_{RP}) is completed. This is determined as if an explicit PRECHARGE command was issued at the earliest possible time, as described for each burst type in the Operation section of this specification.

7.9 Refresh Requirements

LPDDR SDRAM devices require a refresh of all rows in any rolling 64ms interval. Each refresh is generated in one of two ways: by an explicit AUTO REFRESH command, or by an internally timed event in SELF REFRESH mode. Dividing the number of device rows into the rolling 64ms interval defines the average refresh interval (t_{REFI}), which is a guideline to controllers for distributed refresh timing.

7.10 Auto Refresh

AUTO REFRESH command is used during normal operation of the LPDDR SDRAM. This command is non persistent, so it must be issued each time a refresh is required.

The refresh addressing is generated by the internal refresh controller. The LPDDR SDRAM requires AUTO REFRESH commands at an average periodic interval of t_{REFI} .

7.10.1 Auto Refresh Command



7.11 Self Refresh

The SELF REFRESH command can be used to retain data in the LPDDR SDRAM, even if the rest of the system is powered down. When in the Self Refresh mode, the LPDDR SDRAM retains data without external clocking. The LPDDR SDRAM device has a built-in timer to accommodate Self Refresh operation. The SELF REFRESH command is initiated like an AUTO REFRESH command except CKE is LOW. Input signals except CKE are "Don't Care" during Self Refresh. The user may halt the external clock one clock after the SELF REFRESH command is registered.

Once the command is registered, CKE must be held low to keep the device in Self Refresh mode. The clock is internally disabled during Self Refresh operation to save power. The minimum time that the device must remain in Self Refresh mode is t_{RFC} .

The procedure for exiting Self Refresh requires a sequence of commands. First, the clock must be stable prior to CKE going back High. Once Self Refresh Exit is registered, a delay of at least t_{XS} must be satisfied before a valid command can be issued to the device to allow for completion of any internal refresh in progress.

The use of Self Refresh mode introduces the possibility that an internally timed refresh event can be missed when CKE is raised for exit from Self Refresh mode. Upon exit from Self Refresh an extra AUTO REFRESH command is recommended.

In the Self Refresh mode, one additional power-saving option exist: Partial Array Self Refresh (PASR); It is described in the Extended Mode Register section.



7.11.1 Self Refresh Command

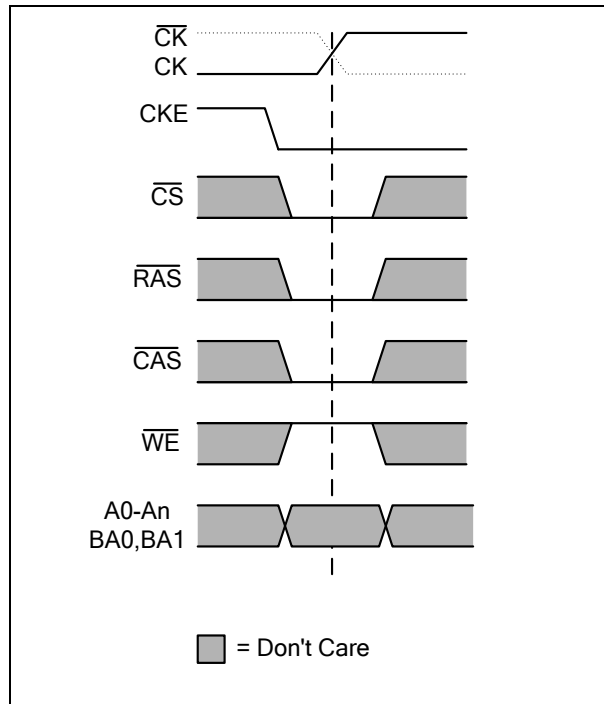

7.11.2 Auto Refresh Cycles Back-to-Back

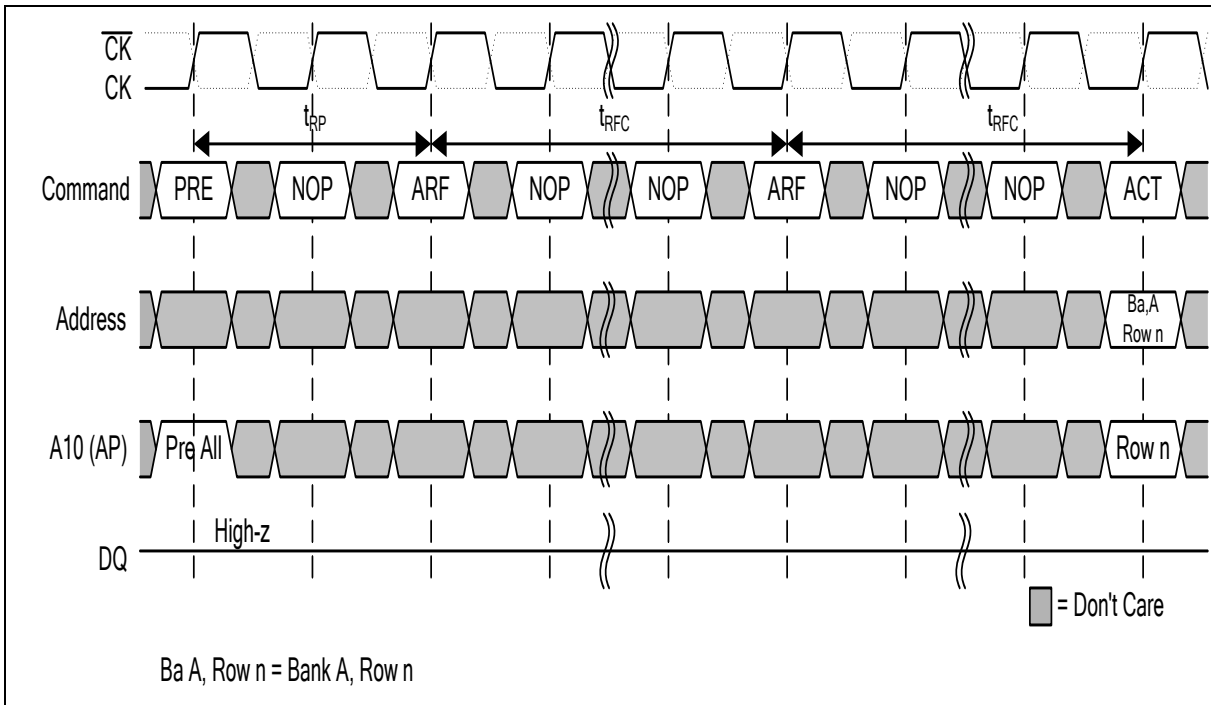



7.11.3 Self Refresh Entry and Exit



7.12 Power Down

Power-down is entered when CKE is registered Low (no accesses can be in progress). If power-down occurs when all banks are idle, this mode is referred to as precharge power-down; if power-down occurs when there is a row active in any bank, this mode is referred to as active power-down.

Entering power-down deactivates the input and output buffers, excluding CK, \overline{CK} and CKE. In power-down mode, CKE Low must be maintained, and all other input signals are "Don't Care". The minimum power-down duration is specified by tCKE. However, power-down duration is limited by the refresh requirements of the device.

The power-down state is synchronously exited when CKE is registered High (along with a NOP or DESELECT command). A valid command may be applied tXP after exit from power-down.

For Clock Stop during Power-Down mode, please refer to the Clock Stop subsection in this specification.

7.12.1 Power-Down Entry and Exit





7.13 Deep Power Down

The Deep Power-Down (DPD) mode enables very low standby currents. All internal voltage generators inside the LPDDR SDRAM are stopped and all memory data is lost in this mode. All the information in the Mode Register and the Extended Mode Register is lost.

Deep Power-Down is entered using the BURST TERMINATE command except that CKE is registered Low. All banks must be in idle state with no activity on the data bus prior to entering the DPD mode. While in this state, CKE must be held in a constant Low state.

To exit the DPD mode, CKE is taken high after the clock is stable and NOP commands must be maintained for at least 200 μ s. After 200 μ s a complete re-initialization is required following steps 4 through 11 as defined for the initialization sequence.

7.13.1 Deep Power-Down Entry and Exit





7.14 Clock Stop

Stopping a clock during idle periods is an effective method of reducing power consumption.

The LPDDR SDRAM supports clock stop under the following conditions:

- the last command (ACTIVE, READ, WRITE, PRECHARGE, AUTO REFRESH or MODE REGISTER SET) has executed to completion, including any data-out during read bursts; the number of clock pulses per access command depends on the device's AC timing parameters and the clock frequency;
- the related timing conditions (t_{RCD} , t_{WR} , t_{RP} , t_{RFC} , t_{MRD}) has been met;
- CKE is held High

When all conditions have been met, the device is either in "idle state" or "row active state" and clock stop mode may be entered with CK held Low and \overline{CK} held High.

Clock stop mode is exited by restarting the clock. At least one NOP command has to be issued before the next access command may be applied. Additional clock pulses might be required depending on the system characteristics.

The following Figure shows clock stop mode entry and exit.

- Initially the device is in clock stop mode
- The clock is restarted with the rising edge of T0 and a NOP on the command inputs
- With T1 a valid access command is latched; this command is followed by NOP commands in order to allow for clock stop as soon as this access command is completed
- Tn is the last clock pulse required by the access command latched with T1
- The clock can be stopped after Tn

7.14.1 Clock Stop Mode Entry and Exit





8. ELECTRICAL CHARACTERISTIC

8.1 Absolute Maximum Ratings

PARAMETER	SYMBOL	VALUES		UNITS
		MIN	MAX	
Voltage on VDD relative to VSS	VDD	-0.3	2.7	V
Voltage on VDDQ relative to VSS	VDDQ	-0.3	2.7	V
Voltage on any pin relative to VSS	VIN, VOUT	-0.3	2.7	V
Operating Case Temperature	Tc	-25	85	°C
		-40	85	
Storage Temperature	TSTG	-55	150	°C
Short Circuit Output Current	IOUT		±50	mA
Power Dissipation	PD		1.0	W

8.2 Input/Output Capacitance

[Notes 1-3]

PARAMETER	SYMBOL	MIN	MAX	UNITS	NOTES
Input capacitance, CK, $\overline{\text{CK}}$	CCK	1.5	3.0	pF	
Input capacitance delta, CK, $\overline{\text{CK}}$	CDCK		0.25	pF	
Input capacitance, all other input-only pins	CI	1.5	3.0	pF	
Input capacitance delta, all other input-only pins	CDI		0.5	pF	
Input/ output capacitance, DQ,DM,DQS	CIO	3.0	5.0	pF	4
Input/output capacitance delta, DQ, DM, DQS	CDIO		0.50	pF	4

Notes:

1. These values are guaranteed by design and are tested on a sample base only.
2. These capacitance values are for single monolithic devices only. Multiple die packages will have parallel capacitive loads.
3. Although DM is an input-only pin, the input capacitance of this pin must model the input capacitance of the DQ and DQS pins. This is required to match signal propagation times of DQ, DQS and DM in the system.



8.3 Electrical Characteristics and AC/DC Operating Conditions

All values are recommended operating conditions unless otherwise noted.

8.3.1 Electrical Characteristics and AC/DC Operating Conditions

PARAMETER/CONDITION	SYMBOL	MIN	MAX	UNITS	NOTES
Supply Voltage	VDD	1.70	1.95	V	
I/O Supply Voltage	VDDQ	1.70	1.95	V	
ADDRESS AND COMMAND INPUTS (A0~An, BA0,BA1,CKE, \overline{CS}, \overline{RAS}, \overline{CAS}, \overline{WE})					
Input High Voltage	VIH	0.8*VDDQ	VDDQ + 0.3	V	
Input Low Voltage	VIL	-0.3	0.2*VDDQ	V	
CLOCK INPUTS (CK, \overline{CK})					
DC Input Voltage	VIN	-0.3	VDDQ + 0.3	V	
DC Input Differential Voltage	VID (DC)	0.4*VDDQ	VDDQ + 0.6	V	2
AC Input Differential Voltage	VID (AC)	0.6*VDDQ	VDDQ + 0.6	V	2
AC Differential Crossing Voltage	VIX	0.4*VDDQ	0.6*VDDQ	V	3
DATA INPUTS (DQ, DM, DQS)					
DC Input High Voltage	VIHD (DC)	0.7*VDDQ	VDDQ + 0.3	V	
DC Input Low Voltage	VILD (DC)	-0.3	0.3*VDDQ	V	
AC Input High Voltage	VIHD (AC)	0.8*VDDQ	VDDQ + 0.3	V	
AC Input Low Voltage	VILD (AC)	-0.3	0.2*VDDQ	V	
DATA OUTPUTS (DQ, DQS)					
DC Output High Voltage (IOH=-0.1mA)	VOH	0.9*VDDQ	-	V	
DC Output Low Voltage (IOL=0.1mA)	VOL	-	0.1*VDDQ	V	
Leakage Current					
Input Leakage Current	IiL	-1	1	uA	
Output Leakage Current	IoL	-5	5	uA	

Notes:

1. All voltages referenced to VSS and VSSQ must be same potential.
2. VID (DC) and VID (AC) are the magnitude of the difference between the input level on CK and \overline{CK} .
3. The value of VIX is expected to be 0.5*VDDQ and must track variations in the DC level of the same.



8.4 IDD Specification Parameters and Test Conditions

8.4.1 IDD Specification Parameters and Test Conditions

[Recommended Operating Conditions; Notes 1-3]

(128Mb, X16)

PARAMETER	SYMBOL	TEST CONDITION	- 5	- 6	- 75	UNIT	
Operating one bank active-precharge current	IDD0	tRC = tRCmin ; tCK = tCKmin ; CKE is HIGH; \overline{CS} is HIGH between valid commands; address inputs are SWITCHING; data bus inputs are STABLE	40	38	35	mA	
Precharge power-down standby current	IDD2P	all banks idle, CKE is LOW; \overline{CS} is HIGH, tCK = tCKmin ; address and control inputs are SWITCHING; data bus inputs are STABLE	Low power	0.23	0.23	0.23	mA
			Normal power	0.28	0.28	0.28	
Precharge power-down standby current with clock stop	IDD2PS	all banks idle, CKE is LOW; \overline{CS} is HIGH, CK = LOW, \overline{CK} = HIGH; address and control inputs are SWITCHING; data bus inputs are STABLE	Low power	0.23	0.23	0.23	mA
			Normal power	0.28	0.28	0.28	
Precharge non power-down standby current	IDD2N	all banks idle, CKE is HIGH; \overline{CS} is HIGH, tCK = tCKmin; address and control inputs are SWITCHING; data bus inputs are STABLE	10	10	10	mA	
Precharge non power-down standby current with clock stop	IDD2NS	all banks idle, CKE is HIGH; \overline{CS} is HIGH, CK = LOW, \overline{CK} = HIGH; address and control inputs are SWITCHING; data bus inputs are STABLE	3	3	3	mA	
Active power-down standby current	IDD3P	one bank active, CKE is LOW; \overline{CS} is HIGH, tCK = tCKmin; address and control inputs are SWITCHING; data bus inputs are STABLE	3	3	3	mA	
Active power-down standby current with clock stop	IDD3PS	one bank active, CKE is LOW; \overline{CS} is HIGH, CK = LOW, \overline{CK} = HIGH; address and control inputs are SWITCHING; data bus inputs are STABLE	3	3	3	mA	
Active non power-down standby current	IDD3N	one bank active, CKE is HIGH; \overline{CS} is HIGH, tCK = tCKmin; address and control inputs are SWITCHING; data bus inputs are STABLE	25	20	20	mA	
Active non power-down standby current with clock stop	IDD3NS	one bank active, CKE is HIGH; \overline{CS} is HIGH, CK = LOW, \overline{CK} = HIGH; address and control inputs are SWITCHING; data bus inputs are STABLE	15	12	12	mA	
Operating burst read current	IDD4R	one bank active; BL = 4; CL = 3; tCK = tCKmin ; continuous read bursts; IOOUT = 0 mA; address inputs are SWITCHING; 50% data change each burst transfer	75	70	70	mA	
Operating burst write current	IDD4W	one bank active; BL = 4; tCK = tCKmin ; continuous write bursts; address inputs are SWITCHING; 50% data change each burst transfer	55	50	50	mA	
Auto-Refresh Current	IDD5	tRC = tRFCmin ; tCK = tCKmin ; burst refresh; CKE is HIGH; address and control inputs are SWITCHING; data bus inputs are STABLE	50	50	50	mA	
Deep Power-Down current	IDD8(4)	Address and control inputs are STABLE; data bus inputs are STABLE	10	10	10	uA	



(128Mb, X32)

PARAMETER	SYMBOL	TEST CONDITION	- 5	- 6	- 75	UNIT	
Operating one bank active-precharge current	IDD0	tRC = tRCmin ; tCK = tCKmin ; CKE is HIGH; \overline{CS} is HIGH between valid commands; address inputs are SWITCHING; data bus inputs are STABLE	40	38	35	mA	
Precharge power-down standby current	IDD2P	all banks idle, CKE is LOW; \overline{CS} is HIGH, tCK = tCKmin ; address and control inputs are SWITCHING; data bus inputs are STABLE	Low power	0.23	0.23	0.23	mA
			Normal power	0.28	0.28	0.28	
Precharge power-down standby current with clock stop	IDD2PS	all banks idle, CKE is LOW; \overline{CS} is HIGH, CK = LOW, \overline{CK} = HIGH; address and control inputs are SWITCHING; data bus inputs are STABLE	Low power	0.23	0.23	0.23	mA
			Normal power	0.28	0.28	0.28	
Precharge non power-down standby current	IDD2N	all banks idle, CKE is HIGH; \overline{CS} is HIGH, tCK = tCKmin; address and control inputs are SWITCHING; data bus inputs are STABLE	10	10	10	mA	
Precharge non power-down standby current with clock stop	IDD2NS	all banks idle, CKE is HIGH; \overline{CS} is HIGH, CK = LOW, \overline{CK} = HIGH; address and control inputs are SWITCHING; data bus inputs are STABLE	3	3	3	mA	
Active power-down standby current	IDD3P	one bank active, CKE is LOW; \overline{CS} is HIGH, tCK = tCKmin; address and control inputs are SWITCHING; data bus inputs are STABLE	3	3	3	mA	
Active power-down standby current with clock stop	IDD3PS	one bank active, CKE is LOW; \overline{CS} is HIGH, CK = LOW, \overline{CK} = HIGH; address and control inputs are SWITCHING; data bus inputs are STABLE	3	3	3	mA	
Active non power-down standby current	IDD3N	one bank active, CKE is HIGH; \overline{CS} is HIGH, tCK = tCKmin; address and control inputs are SWITCHING; data bus inputs are STABLE	25	20	20	mA	
Active non power-down standby current with clock stop	IDD3NS	one bank active, CKE is HIGH; \overline{CS} is HIGH, CK = LOW, \overline{CK} = HIGH; address and control inputs are SWITCHING; data bus inputs are STABLE	15	12	12	mA	
Operating burst read current	IDD4R	one bank active; BL = 4; CL = 3; tCK = tCKmin ; continuous read bursts; IOUT = 0 mA; address inputs are SWITCHING; 50% data change each burst transfer	75	70	70	mA	
Operating burst write current	IDD4W	one bank active; BL = 4; tCK = tCKmin ; continuous write bursts; address inputs are SWITCHING; 50% data change each burst transfer	55	50	50	mA	
Auto-Refresh Current	IDD5	tRC = tRFCmin ; tCK = tCKmin ; burst refresh; CKE is HIGH; address and control inputs are SWITCHING; data bus inputs are STABLE	50	50	50	mA	
Deep Power-Down current	IDD8(4)	Address and control inputs are STABLE; data bus inputs are STABLE	10	10	10	uA	

Notes:

1. IDD specifications are tested after the device is properly initialized.
2. Input slew rate is 1V/ns.
3. Definitions for IDD:
 LOW is defined as $V_{IN} \leq 0.1 * V_{DDQ}$; HIGH is defined as $V_{IN} \geq 0.9 * V_{DDQ}$; STABLE is defined as inputs stable at a HIGH or LOW level;
 SWITCHING is defined as:
 - Address and command: inputs changing between HIGH and LOW once per two clock cycles;
 - Data bus inputs: DQ changing between HIGH and LOW once per clock cycle; DM and DQS are STABLE.
4. IDD8 are typical value at 25°C.



IDD6 Conditions :

IDD6	Low Power		Normal Power		Units
	45°C	85°C	45°C	85°C	
ATCSR Range	45°C	85°C	45°C	85°C	uA
Full Array	180	230	220	280	
1/2 Array	160	200	190	250	
1/4 Array	150	180	170	230	

Notes:

1. Measured with outputs open.
2. IDD6 is typical value..



8.5 AC Timings

[Recommended Operating Conditions: Notes 1-9]

PARAMETER		SYMBOL	- 5		- 6		- 75		UNIT	NOTES
			MIN	MAX	MIN	MAX	MIN	MAX		
DQ output access time from CK/ $\overline{\text{CK}}$	CL=3	tAC	2.0	5.0	2.0	5.0	2.0	6.0	ns	
	CL=2		2.0	6.5	2.0	6.5	2.0	6.5		
DQS output access time from CK	CL=3	tDQSCK	2.0	5.0	2.0	5.0	2.0	6.0	ns	
	CL=2		2.0	6.5	2.0	6.5	2.0	6.5		
Clock high-level width		tCH	0.45	0.55	0.45	0.55	0.45	0.55	tCK	
Clock low-level width		tCL	0.45	0.55	0.45	0.55	0.45	0.55	tCK	
Clock half period		tHP	Min (tCL, tCH)		Min (tCL, tCH)		Min (tCL, tCH)		ns	10,11
Clock cycle time	CL=3	tCK	5		6		7.5		ns	12
	CL=2		12		12		12		ns	12
DQ and DM input setup time	fast	tDS	0.48		0.6		0.8		ns	13,14,15
	slow		0.58		0.7		0.9		ns	13,14,16
DQ and DM input hold time	fast	tDH	0.48		0.6		0.8		ns	13,14,15
	slow		0.58		0.7		0.9		ns	13,14,16
DQ and DM input pulse width		tDIPW	1.6		1.6		1.8		ns	17
Address and control input setup time	fast	tIS	0.9		1.1		1.3		ns	15,18
	slow		1.1		1.3		1.5		ns	16,18
Address and control input hold time	fast	tIH	0.9		1.1		1.3		ns	15,18
	slow		1.1		1.3		1.5		ns	16,18
Address and control input pulse width		tIPW	2.3		2.6		2.6		ns	17
DQ & DQS low-impedance time from CK/ $\overline{\text{CK}}$		tLZ	1.0		1.0		1.0		ns	19
DQ & DQS high-impedance time from CK/ $\overline{\text{CK}}$	CL=3	tHZ		5.0		5.0		6.0	ns	19
	CL=2			6.5		6.5		6.5		
DQS-DQ skew		tDQSQ		0.4		0.5		0.6	ns	20
DQ/DQS output hold time from DQS		tQH	tHP-tQHS		tHP-tQHS		tHP-tQHS		ns	11
Data hold skew factor		tQHS		0.5		0.65		0.75	ns	11
Write command to 1st DQS latching transition		tDQSS	0.75	1.25	0.75	1.25	0.75	1.25	tCK	
DQS input high-level width		tDQSH	0.4	0.6	0.4	0.6	0.4	0.6	tCK	
DQS input low-level width		tDQSL	0.4	0.6	0.4	0.6	0.4	0.6	tCK	
DQS falling edge to CK setup time		tDSS	0.2		0.2		0.2		tCK	
DQS falling edge hold time from CK		tDSH	0.2		0.2		0.2		tCK	
MODE REGISTER SET command		tMRD	2		2		2		tCK	



PARAMETER	SYMBOL	- 5		- 6		- 75		UNIT	NOTES	
		MIN	MAX	MIN	MAX	MIN	MAX			
period										
Write preamble setup time	tWPRES	0		0		0		ns	21	
Write postamble	tWPST	0.4	0.6	0.4	0.6	0.4	0.6	tCK	22	
Write preamble	tWPRE	0.25		0.25		0.25		tCK		
Read preamble	tRPRE	CL = 3	0.9	1.1	0.9	1.1	0.9	1.1	tCK	23
		CL = 2	0.5	1.1	0.5	1.1	0.5	1.1	tCK	23
Read postamble	tRPST	0.4	0.6	0.4	0.6	0.4	0.6	tCK		
ACTIVE to PRECHARGE command period	tRAS	40	70,000	42	70,000	45	70,000	ns		
ACTIVE to ACTIVE command period	tRC	tRAS+		tRAS+		tRAS+		ns		
		tRP		tRP		tRP				
AUTO REFRESH to ACTIVE/AUTO REFRESH command period	tRFC	72		72		72		ns		
ACTIVE to READ or WRITE delay	tRCD	15		18		22.5		ns		
PRECHARGE command period	tRP	3		3		3		tCK		
ACTIVE bank A to ACTIVE bank B delay	tRRD	10		12		15		ns		
WRITE recovery time	tWR	15		15		15		ns	24	
Auto precharge write recovery + precharge time	tDAL	-		-		-		tCK	25	
Internal write to Read command delay	tWTR	2		2		1		tCK		
Self Refresh exit to next valid command delay	tXSR	120		120		120		ns	26	
Exit power down to next valid command delay	tXP	2		1		1		tCK	27	
CKE min. pulse width (high and low pulse width)	tCKE	1		1		1		tCK		
Refresh Period	tREF		64		64		64	ms		
Average periodic refresh interval	tREFI		15.6		15.6		15.6	μs	28	
MRS for SRR to READ	tSRR	2		2		2		tCK		
READ of SRR to next valid command	tSRC	CL+1		CL+1		CL+1		tCK		

Notes:

1. All voltages referenced to VSS.
2. All parameters assume proper device initialization.
3. Tests for AC timing may be conducted at nominal supply voltage levels, but the related specifications and device operation are guaranteed for the full voltage and temperature range specified.
4. The circuit shown below represents the timing reference load used in defining the relevant timing parameters of the part. It is not intended to be either a precise representation of the typical system environment nor a depiction of the actual load presented by a production tester. System designers will use IBIS or other simulation tools to correlate the timing reference load to system environment. Manufacturers will correlate to their production test conditions (generally a coaxial transmission line terminated at the tester electronics). For the half strength driver with a nominal 10pF load parameters tAC and tQH are expected to be in the same range. However, these parameters are not subject to production test but are estimated by design / characterization. Use of IBIS or other simulation tools for system design validation is suggested.



5. The $\overline{\text{CK}}/\overline{\text{CK}}$ input reference voltage level (for timing referenced to $\overline{\text{CK}}/\overline{\text{CK}}$) is the point at which CK and $\overline{\text{CK}}$ cross; the input reference voltage level for signals other than $\overline{\text{CK}}/\overline{\text{CK}}$ is VDDQ/2.
6. The timing reference voltage level is VDDQ/2.
7. AC and DC input and output voltage levels are defined in the section for Electrical Characteristics and AC/DC operating conditions.
8. A $\overline{\text{CK}}/\overline{\text{CK}}$ differential slew rate of 2.0 V/ns is assumed for all parameters.
9. $\overline{\text{CAS}}$ latency definition: with CL = 3 the first data element is valid at (2 * tCK + tAC) after the clock at which the READ command was registered; with CL = 2 the first data element is valid at (tCK + tAC) after the clock at which the READ command was registered
10. Min (tCL, tCH) refers to the smaller of the actual clock low time and the actual clock high time as provided to the device (i.e. this value can be greater than the minimum specification limits of tCL and tCH)
11. tQH = tHP - tQHS, where tHP = minimum half clock period for any given cycle and is defined by clock high or clock low (tCL, tCH). tQHS accounts for 1) the pulse duration distortion of on-chip clock circuits; and 2) the worst case push-out of DQS on one transition followed by the worst case pull-in of DQ on the next transition, both of which are, separately, due to data pin skew and output pattern effects, and p-channel to n-channel variation of the output drivers.
12. The only time that the clock frequency is allowed to change is during clock stop, power-down or self-refresh modes.
13. The transition time for DQ, DM and DQS inputs is measured between VIL(DC) to VIH(AC) for rising input signals, and VIH(DC) to VIL(AC) for falling input signals.
14. DQS, DM and DQ input slew rate is specified to prevent double clocking of data and preserve setup and hold times. Signal transitions through the DC region must be monotonic.
15. Input slew rate $\geq 1.0 \text{ V/ns}$.
16. Input slew rate $\geq 0.5 \text{ V/ns}$ and $< 1.0 \text{ V/ns}$.
17. These parameters guarantee device timing but they are not necessarily tested on each device.
18. The transition time for address and command inputs is measured between VIH and VIL.



128Mb Mobile LPDDR

19. tHZ and tLZ transitions occur in the same access time windows as valid data transitions. These parameters are not referred to a specific voltage level, but specify when the device is no longer driving (HZ), or begins driving (LZ).
20. tDQSQ consists of data pin skew and output pattern effects, and p-channel to n-channel variation of the output drivers for any given cycle.
21. The specific requirement is that DQS be valid (HIGH, LOW, or some point on a valid transition) on or before the corresponding CK edge. A valid transition is defined as monotonic and meeting the input slew rate specifications of the device. When no writes were previously in progress on the bus, DQS will be transitioning from Hi-Z to logic LOW. If a previous write was in progress, DQS could be HIGH, LOW, or transitioning from HIGH to LOW at this time, depending on tDQSS.
22. The maximum limit for this parameter is not a device limit. The device operates with a greater value for this parameter, but system performance (bus turnaround) will degrade accordingly.
23. A low level on DQS may be maintained during High-Z states (DQS drivers disabled) by adding a weak pull-down element in the system. It is recommended to turn off the weak pull-down element during read and write bursts (DQS drivers enabled).
24. At least one clock cycle is required during tWR time when in auto precharge mode.
25. tDAL = (tWR/tCK) + (tRP/tCK): for each of the terms, if not already an integer, round to the next higher integer.
26. There must be at least two clock pulses during the tXSR period.
27. There must be at least one clock pulse during the tXP period.
28. A maximum of 8 Refresh commands can be posted to any given LPDDR SDRAM, meaning that the maximum absolute interval between any Refresh command and the next Refresh command is 8*tREFI.

8.5.1 CAS Latency Definition (With CL=3)





8.5.2 Output Slew Rate Characteristics

PARAMETER	MIN	MAX	UNIT	NOTES
Pull-up and Pull-Down Slew Rate for Full Strength Driver	0.7	2.5	V/ns	1,2
Pull-up and Pull-Down Slew Rate for Three-Quarter Strength Driver	0.5	1.75	V/ns	1,2
Pull-up and Pull-Down Slew Rate for Half Strength Driver	0.3	1.0	V/ns	1,2
Output Slew rate Matching ratio (Pull-up to Pull-down)	0.7	1.4	-	3

Notes:

1. Measured with a test load of 20 pF connected to VSSQ.
2. Output slew rate for rising edge is measured between VILD(DC) to VIH(DC) and for falling edge between VIH(DC) to VILD(DC).
3. The ratio of pull-up slew rate to pull-down slew rate is specified for the same temperature and voltage, over the entire temperature and voltage range. For a given output, it represents the maximum difference between pull-up and pull-down drivers due to process variation.

8.5.3 AC Overshoot/Undershoot Specification

PARAMETER	SPECIFICATION
Maximum peak amplitude allowed for overshoot	0.5 V
Maximum peak amplitude allowed for undershoot	0.5 V
The area between overshoot signal and VDD must be less than or equal to	3 V-ns
The area between undershoot signal and GND must be less than or equal to	3 V-ns

8.5.4 AC Overshoot and Undershoot Definition





9. PACKAGE DIMENSIONS

9.1: LPDDR X 16

VBGA60Ball (8X9 MM², Ball pitch:0.8mm)



Symbol	Dimension in mm			Dimension in inch		
	MIN	NOM	MAX	MIN	NOM	MAX
A	---	---	1.025	---	---	0.040
A1	0.275	0.300	0.325	0.011	0.012	0.013
A2	0.61	0.66	0.71	0.024	0.026	0.028
D	7.90	8.00	8.10	0.311	0.315	0.319
E	8.90	9.00	9.10	0.350	0.354	0.358
D1	---	6.40	---	---	0.252	---
E1	---	7.20	---	---	0.283	---
e	---	0.80	---	---	0.031	---
b	0.40	0.45	0.50	0.016	0.018	0.020
aaa		0.15			0.006	
bbb		0.20			0.008	
ccc		0.12			0.005	



Note:

1. Ball land:0.5mm. Ball opening:0.4mm. PCB Ball land suggested $\leq 0.4\text{mm}$
2. Dimensions apply to Solder Balls Post-Reflow. The Pre-Reflow diameter is 0.42 on a 0.4 SMD Ball Pad.



9.2: LPDDR X 32

VBGA90Ball (8X13 MM², Ball pitch:0.8mm)

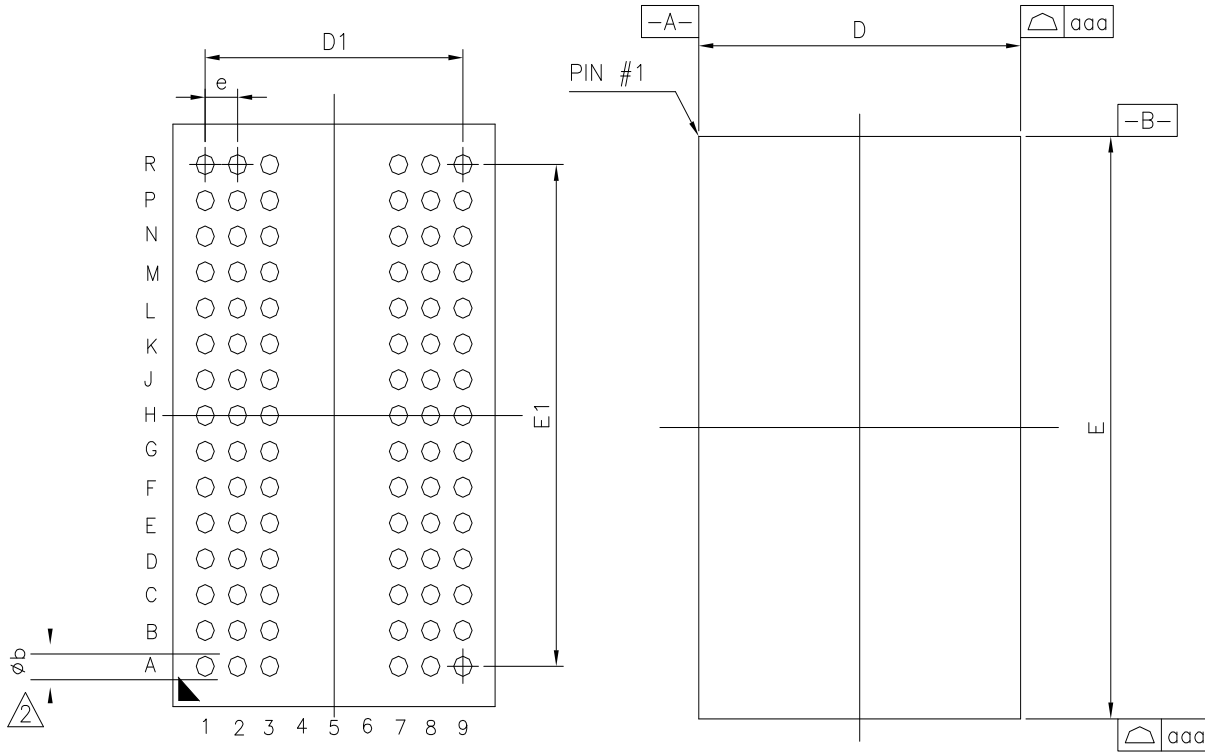

Symbol	Dimension in mm			Dimension in inch		
	MIN	NOM	MAX	MIN	NOM	MAX
A	---	---	1.025	---	---	0.040
A1	0.275	0.300	0.325	0.011	0.012	0.013
A2	0.61	0.66	0.71	0.024	0.026	0.028
D	7.90	8.00	8.10	0.311	0.315	0.319
E	12.90	13.00	13.10	0.508	0.512	0.516
D1	---	6.40	---	---	0.252	---
E1	---	11.20	---	---	0.441	---
e	---	0.80	---	---	0.031	---
b	0.40	0.45	0.50	0.016	0.018	0.020
aaa		0.15			0.006	
bbb		0.20			0.008	
ccc		0.12			0.005	



Note:

1. Ball land:0.5mm. Ball opening:0.4mm. PCB Ball land suggested $\leq 0.4\text{mm}$
2. Dimensions apply to Solder Balls Post-Reflow. The Pre-Reflow diameter is 0.42 on a 0.4 SMD Ball Pad.



10. ORDERING INFORMATION

Mobile LPDDR/LPSDR SDRAM Package Part Numbering

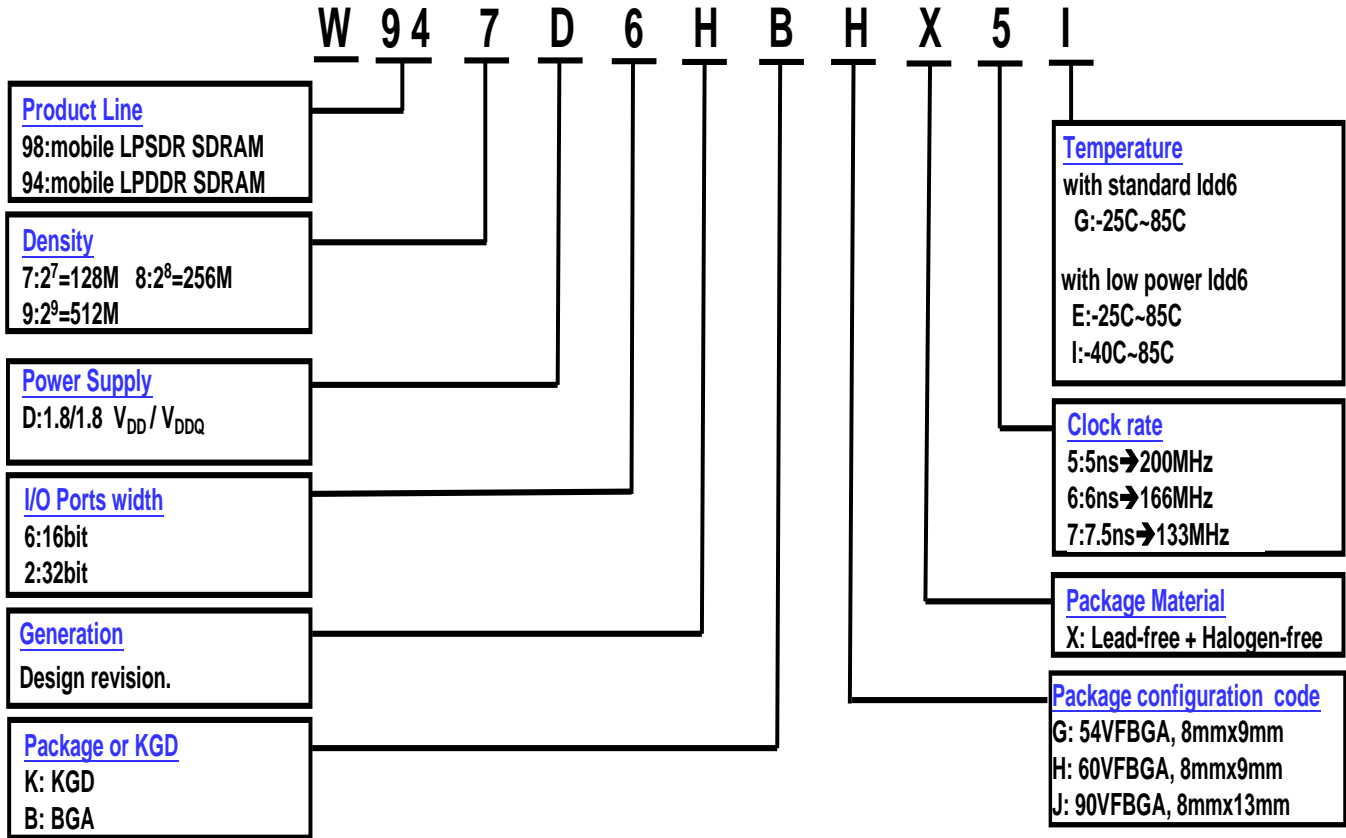

Part number	V _{DD} /V _{DDQ}	IO width	Package	Others
W947D6HBHX5I	1.8V/1.8V	16	60VFBGA	200MHz, -40C~85C, Low power
W947D6HBHX5E	1.8V/1.8V	16	60VFBGA	200MHz, -25C~85C, Low power
W947D6HBHX6E	1.8V/1.8V	16	60VFBGA	166MHz, -25C~85C, Low power
W947D6HBHX6G	1.8V/1.8V	16	60VFBGA	166MHz, -25C~85C
W947D2HBX5I	1.8V/1.8V	32	90VFBGA	200MHz, -40C~85C, Low power
W947D2HBX5E	1.8V/1.8V	32	90VFBGA	200MHz, -25C~85C, Low power
W947D2HBX6E	1.8V/1.8V	32	90VFBGA	166MHz, -25C~85C, Low power
W947D2HBX6G	1.8V/1.8V	32	90VFBGA	166MHz, -25C~85C



11. REVISION HISTORY

VERSION	DATE	PAGE	DESCRIPTION
A01-001	04/08/2011	All	Product datasheet for customer.
A01-002	04/18/2011	17 52	Delete "2" in refresh rate of SRR for DQ8~10. Remove IDD6 note 3.
A01-003	06/17/2011	46 47 48,49	Update CcK(Max) to 3 pF. Add IiL & IoL. Update IDD4R & IDD4W value.



Important Notice

Winbond products are not designed, intended, authorized or warranted for use as components in systems or equipment intended for surgical implantation, atomic energy control instruments, airplane or spaceship instruments, transportation instruments, traffic signal instruments, combustion control instruments, or for other applications intended to support or sustain life. Furthermore, Winbond products are not intended for applications wherein failure of Winbond products could result or lead to a situation where in personal injury, death or severe property or environmental damage could occur.

Winbond customers using or selling these products for use in such applications do so at their own risk and agree to fully indemnify Winbond for any damages resulting from such improper use or sales.

Please note that all data and specifications are subject to change without notice.

All the trademarks of products and companies mentioned in the datasheet belong to their respective owners

Mouser Electronics

Authorized Distributor

Click to View Pricing, Inventory, Delivery & Lifecycle Information:

Winbond:

[W947D2HBJX5E TR](#) [W947D6HBHX6E](#) [W947D2HBJX6E](#) [W947D6HBHX5I TR](#) [W947D6HBHX6E TR](#)
[W947D6HBHX5I](#) [W947D2HBJX5I TR](#) [W947D2HBJX6E TR](#) [W947D6HBHX5E](#) [W947D2HBJX5E](#) [W947D2HBJX5I](#)
[W947D6HBHX5E TR](#)

Компания «Океан Электроники» предлагает заключение долгосрочных отношений при поставках импортных электронных компонентов на взаимовыгодных условиях!

Наши преимущества:

- Поставка оригинальных импортных электронных компонентов напрямую с производств Америки, Европы и Азии, а так же с крупнейших складов мира;
- Широкая линейка поставок активных и пассивных импортных электронных компонентов (более 30 млн. наименований);
- Поставка сложных, дефицитных, либо снятых с производства позиций;
- Оперативные сроки поставки под заказ (от 5 рабочих дней);
- Экспресс доставка в любую точку России;
- Помощь Конструкторского Отдела и консультации квалифицированных инженеров;
- Техническая поддержка проекта, помощь в подборе аналогов, поставка прототипов;
- Поставка электронных компонентов под контролем ВП;
- Система менеджмента качества сертифицирована по Международному стандарту ISO 9001;
- При необходимости вся продукция военного и аэрокосмического назначения проходит испытания и сертификацию в лаборатории (по согласованию с заказчиком);
- Поставка специализированных компонентов военного и аэрокосмического уровня качества (Xilinx, Altera, Analog Devices, Intersil, Interpoint, Microsemi, Actel, Aeroflex, Peregrine, VPT, Syfer, Eurofarad, Texas Instruments, MS Kennedy, Miteq, Cobham, E2V, MA-COM, Hittite, Mini-Circuits, General Dynamics и др.);

Компания «Океан Электроники» является официальным дистрибьютором и эксклюзивным представителем в России одного из крупнейших производителей разъемов военного и аэрокосмического назначения «JONHON», а так же официальным дистрибьютором и эксклюзивным представителем в России производителя высокотехнологичных и надежных решений для передачи СВЧ сигналов «FORSTAR».



JONHON

«JONHON» (основан в 1970 г.)

Разъемы специального, военного и аэрокосмического назначения:

(Применяются в военной, авиационной, аэрокосмической, морской, железнодорожной, горно- и нефтедобывающей отраслях промышленности)

«FORSTAR» (основан в 1998 г.)

ВЧ соединители, коаксиальные кабели, кабельные сборки и микроволновые компоненты:

(Применяются в телекоммуникациях гражданского и специального назначения, в средствах связи, РЛС, а так же военной, авиационной и аэрокосмической отраслях промышленности).



Телефон: 8 (812) 309-75-97 (многоканальный)

Факс: 8 (812) 320-03-32

Электронная почта: ocean@oceanchips.ru

Web: <http://oceanchips.ru/>

Адрес: 198099, г. Санкт-Петербург, ул. Калинина, д. 2, корп. 4, лит. А