



ZXTN10150DZ

150V NPN LED DRIVING TRANSISTOR IN SOT89

Features

- $BV_{CEO} > 150V$
- $h_{FE} > 100$ for $I_C = 150mA$, $V_{CE} = 0.25V$
- $I_C (cont) = 1A$
- **Lead Free, RoHS Compliant (Note 1)**
- **Halogen and Antimony Free "Green" Device (Note 2)**
- **Qualified to AEC-Q101 Standards for High Reliability**

Mechanical Data

- Case: SOT-89
- Case Material: Molded Plastic. "Green" Molding Compound.
- UL Flammability Rating 94V-0
- Moisture Sensitivity: Level 1 per J-STD-020
- Terminals: Matte Tin Finish
- Weight: 0.008 grams (Approximate)

Applications

- LED TV backlight



SOT89

Top View

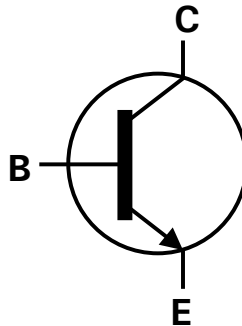

Device symbol

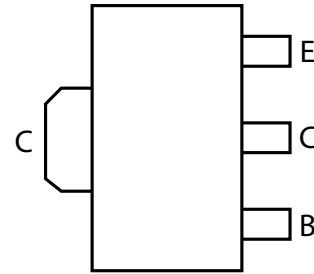

Pinout – top view

Ordering Information

Product	Marking	Reel size (inches)	Tape width (mm)	Quantity per reel
ZXTN10150DZTA	1R4	7	12	1000

- Notes:
1. No purposefully added lead.
 2. "Green" devices, Halogen and Antimony Free, Diodes Inc's "Green" Policy can be found on our website at <http://www.diodes.com>

Marking Information

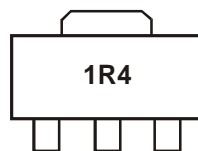

1R4 - Product Type Marking Code

Maximum Ratings @ $T_A = 25^\circ\text{C}$ unless otherwise specified

Characteristic	Symbol	Value	Unit
Collector-Base Voltage	V_{CBO}	150	V
Collector-Emitter Voltage	V_{CEO}	150	V
Emitter-Base Voltage	V_{EBO}	7	V
Continuous Collector Current	I_C	1	A
Peak Pulse Current (Note 4)	I_{CM}	3	A
Base Current	I_B	500	mA

Thermal Characteristics @ $T_A = 25^\circ\text{C}$ unless otherwise specified

Characteristic	Symbol	Value	Unit
Power Dissipation (Note 3)	P_D	1.5	W
Thermal Resistance, Junction to Ambient (Note 3)	$R_{\theta JA}$	83	$^\circ\text{C/W}$
Thermal Resistance, Junction to Leads	$R_{\theta JL}$	6.36	$^\circ\text{C/W}$
Operating and Storage Temperature Range	T_J, T_{STG}	-55 to +150	$^\circ\text{C}$

- Notes:
3. For a device surface mounted on 25mm X 25mm FR4 PCB with high coverage of single sided 1 oz copper, in still air conditions.
 4. Measured under pulsed conditions. Pulse width = 300 μs . Duty cycle $\leq 2\%$.

Thermal Characteristics and Derating information

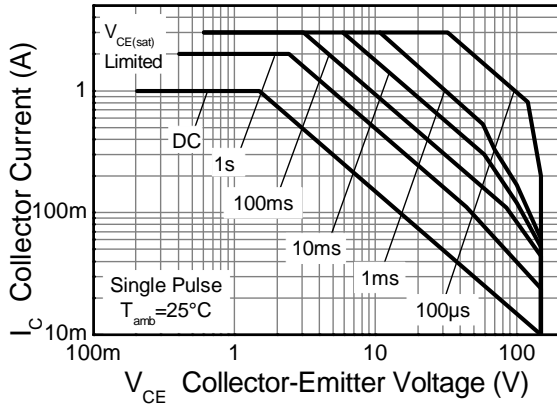

Safe Operating Area

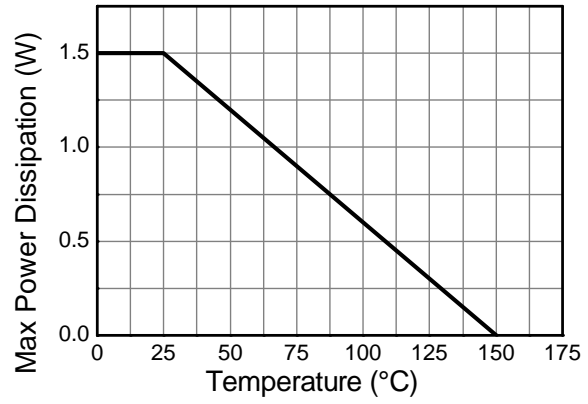

Derating Curve

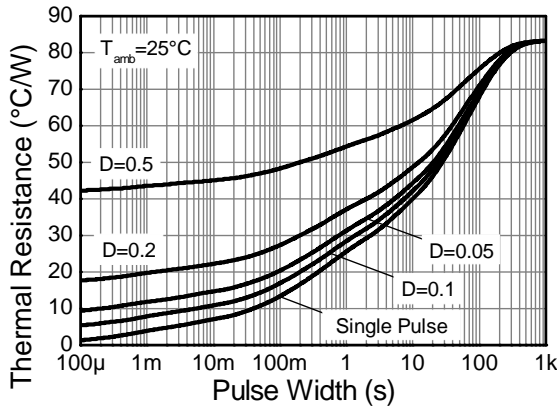

Transient Thermal Impedance

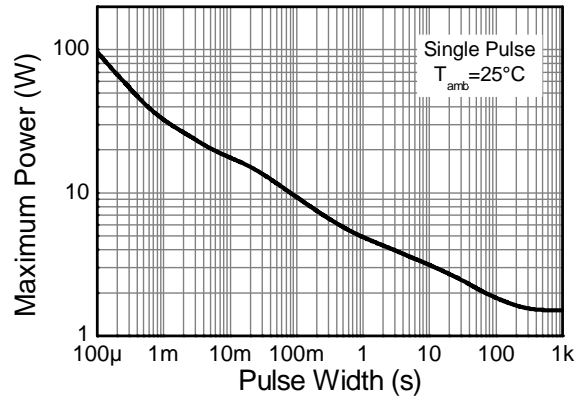

Pulse Power Dissipation

Electrical Characteristics @T_A = 25°C unless otherwise specified

Characteristic	Symbol	Min	Typ	Max	Unit	Test Condition
Collector-Base Breakdown Voltage	BV _{CBO}	150	300	-	V	I _C = 100μA
Collector-Emitter Breakdown Voltage (Note 5)	BV _{CEO}	150	175	-	V	I _C = 10mA
Emitter-Base Breakdown Voltage	BV _{EBO}	7	8.3	-	V	I _E = 100μA
Collector Cut-off Current	I _{CBO}	-	-	50	nA	V _{CB} = 150V
Emitter Cut-off Current	I _{EBO}	-	-	50	nA	V _{EB} = 7V
Static Forward Current Transfer Ratio (Note 5)	h _{FE}	200 60 100	450 180 150	- - -	-	I _C = 30mA, V _{CE} = 5V I _C = 85mA, V _{CE} = 0.20V I _C = 150mA, V _{CE} = 0.25V
Base-Emitter Turn-On Voltage (Note 5)	V _{BE(on)}	-	0.701	0.95	V	I _C = 150mA, V _{CE} = 0.25V
Output Capacitance	C _{OBO}	-	10	-	pF	V _{CB} = 10V, f = 1MHz
Current Gain-Bandwidth Product	f _t	-	135	-	MHz	V _{CB} = 10V, I _C = 10mA, f = 100MHz
Delay Time	t _(d)	-	625	-	ns	V _{CC} = 110V, I _C = 150mA, -I _{B2} = 1.5mA, V _{CE(ON)} = 0.25V
Rise Time	t _(r)	-	562	-	ns	
Storage Time	t _(s)	-	2465	-	ns	
Fall Time	t _(f)	-	289	-	ns	
Storage Time	t _(s)	-	461	-	ns	
Fall Time	t _(f)	-	52	-	ns	V _{CC} = 110V, I _C = 150mA, -I _{B2} = 1.5mA, V _{CE(ON)} = 4V

Notes: 5. Measured under pulsed conditions. Pulse width = 300μs. Duty cycle ≤ 2%

Typical Characteristics

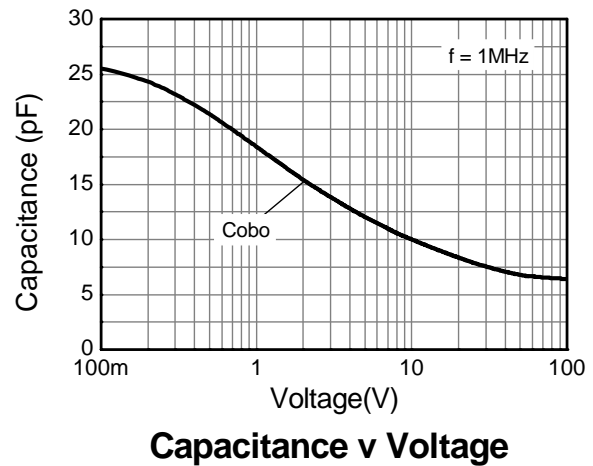
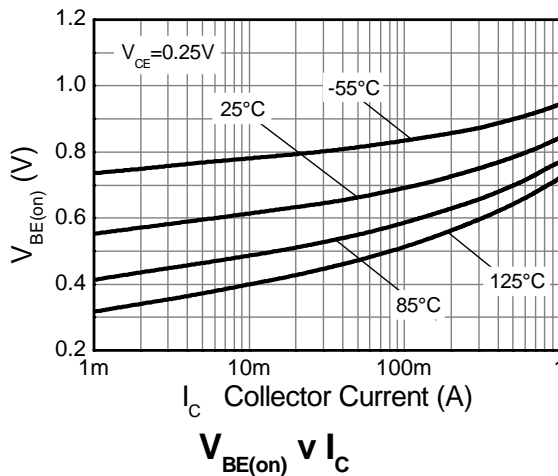
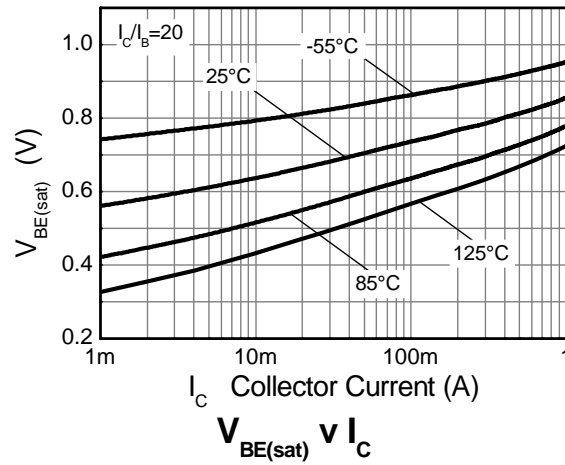
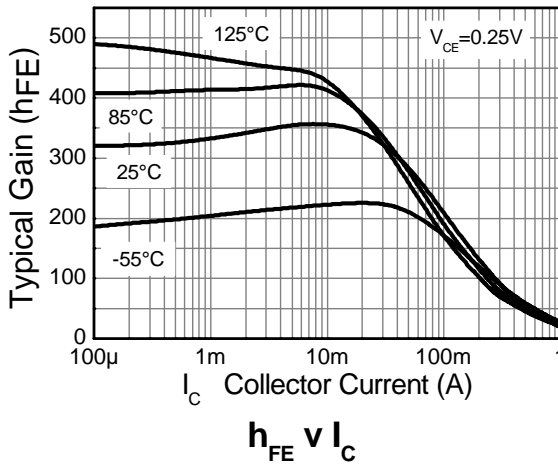
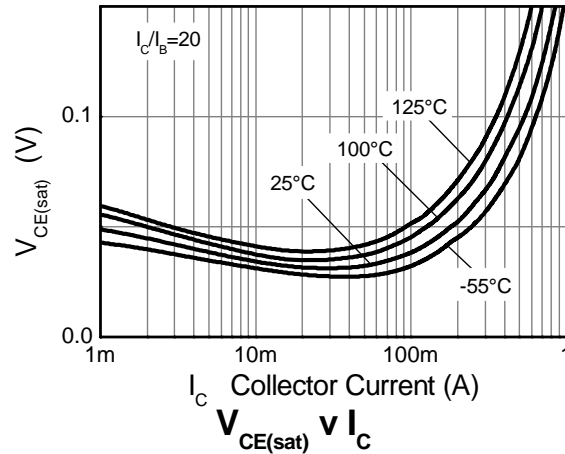
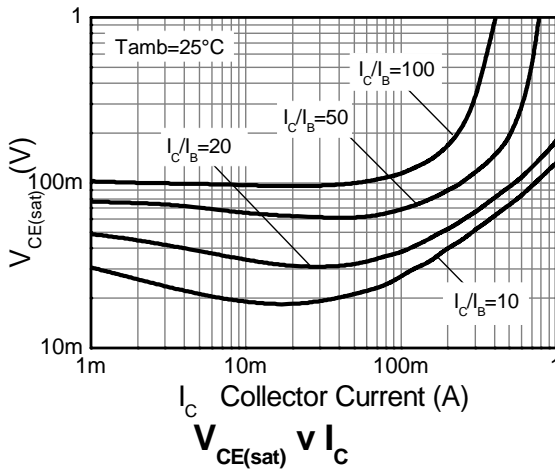

Package Outline Dimensions

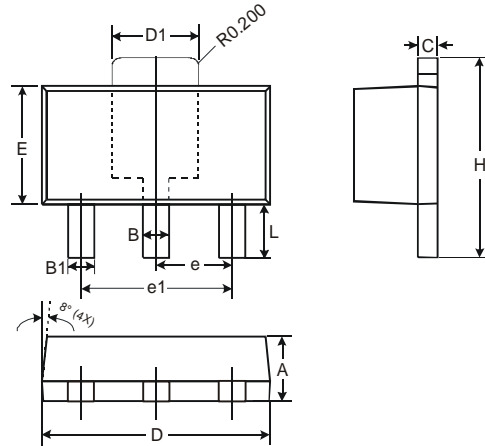

SOT89-3L		
Dim	Min	Max
A	1.40	1.60
B	0.44	0.62
B1	0.35	0.54
C	0.35	0.43
D	4.40	4.60
D1	1.52	1.83
E	2.29	2.60
e	1.50 Typ	
e1	3.00 Typ	
H	3.94	4.25
L	0.89	1.20
All Dimensions in mm		

Suggested Pad Layout

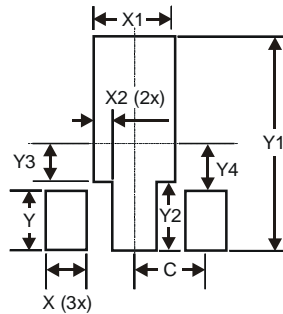

Dimensions	Value (in mm)
X	0.900
X1	1.733
X2	0.416
Y	1.300
Y1	4.600
Y2	1.475
Y3	0.950
Y4	1.125
C	1.500

IMPORTANT NOTICE

DIODES INCORPORATED MAKES NO WARRANTY OF ANY KIND, EXPRESS OR IMPLIED, WITH REGARDS TO THIS DOCUMENT, INCLUDING, BUT NOT LIMITED TO, THE IMPLIED WARRANTIES OF MERCHANTABILITY AND FITNESS FOR A PARTICULAR PURPOSE (AND THEIR EQUIVALENTS UNDER THE LAWS OF ANY JURISDICTION).

Diodes Incorporated and its subsidiaries reserve the right to make modifications, enhancements, improvements, corrections or other changes without further notice to this document and any product described herein. Diodes Incorporated does not assume any liability arising out of the application or use of this document or any product described herein; neither does Diodes Incorporated convey any license under its patent or trademark rights, nor the rights of others. Any Customer or user of this document or products described herein in such applications shall assume all risks of such use and will agree to hold Diodes Incorporated and all the companies whose products are represented on Diodes Incorporated website, harmless against all damages.

Diodes Incorporated does not warrant or accept any liability whatsoever in respect of any products purchased through unauthorized sales channel. Should Customers purchase or use Diodes Incorporated products for any unintended or unauthorized application, Customers shall indemnify and hold Diodes Incorporated and its representatives harmless against all claims, damages, expenses, and attorney fees arising out of, directly or indirectly, any claim of personal injury or death associated with such unintended or unauthorized application.

Products described herein may be covered by one or more United States, international or foreign patents pending. Product names and markings noted herein may also be covered by one or more United States, international or foreign trademarks.

LIFE SUPPORT

Diodes Incorporated products are specifically not authorized for use as critical components in life support devices or systems without the express written approval of the Chief Executive Officer of Diodes Incorporated. As used herein:

A. Life support devices or systems are devices or systems which:

1. are intended to implant into the body, or
2. support or sustain life and whose failure to perform when properly used in accordance with instructions for use provided in the labeling can be reasonably expected to result in significant injury to the user.

B. A critical component is any component in a life support device or system whose failure to perform can be reasonably expected to cause the failure of the life support device or to affect its safety or effectiveness.

Customers represent that they have all necessary expertise in the safety and regulatory ramifications of their life support devices or systems, and acknowledge and agree that they are solely responsible for all legal, regulatory and safety-related requirements concerning their products and any use of Diodes Incorporated products in such safety-critical, life support devices or systems, notwithstanding any devices- or systems-related information or support that may be provided by Diodes Incorporated. Further, Customers must fully indemnify Diodes Incorporated and its representatives against any damages arising out of the use of Diodes Incorporated products in such safety-critical, life support devices or systems.

Copyright © 2010, Diodes Incorporated

www.diodes.com

Компания «Океан Электроники» предлагает заключение долгосрочных отношений при поставках импортных электронных компонентов на взаимовыгодных условиях!

Наши преимущества:

- Поставка оригинальных импортных электронных компонентов напрямую с производств Америки, Европы и Азии, а так же с крупнейших складов мира;
- Широкая линейка поставок активных и пассивных импортных электронных компонентов (более 30 млн. наименований);
- Поставка сложных, дефицитных, либо снятых с производства позиций;
- Оперативные сроки поставки под заказ (от 5 рабочих дней);
- Экспресс доставка в любую точку России;
- Помощь Конструкторского Отдела и консультации квалифицированных инженеров;
- Техническая поддержка проекта, помощь в подборе аналогов, поставка прототипов;
- Поставка электронных компонентов под контролем ВП;
- Система менеджмента качества сертифицирована по Международному стандарту ISO 9001;
- При необходимости вся продукция военного и аэрокосмического назначения проходит испытания и сертификацию в лаборатории (по согласованию с заказчиком);
- Поставка специализированных компонентов военного и аэрокосмического уровня качества (Xilinx, Altera, Analog Devices, Intersil, Interpoint, Microsemi, Actel, Aeroflex, Peregrine, VPT, Syfer, Eurofarad, Texas Instruments, MS Kennedy, Miteq, Cobham, E2V, MA-COM, Hittite, Mini-Circuits, General Dynamics и др.);

Компания «Океан Электроники» является официальным дистрибьютором и эксклюзивным представителем в России одного из крупнейших производителей разъемов военного и аэрокосмического назначения «JONHON», а так же официальным дистрибьютором и эксклюзивным представителем в России производителя высокотехнологичных и надежных решений для передачи СВЧ сигналов «FORSTAR».



JONHON

«JONHON» (основан в 1970 г.)

Разъемы специального, военного и аэрокосмического назначения:

(Применяются в военной, авиационной, аэрокосмической, морской, железнодорожной, горно- и нефтедобывающей отраслях промышленности)

«FORSTAR» (основан в 1998 г.)

ВЧ соединители, коаксиальные кабели, кабельные сборки и микроволновые компоненты:

(Применяются в телекоммуникациях гражданского и специального назначения, в средствах связи, РЛС, а так же военной, авиационной и аэрокосмической отраслях промышленности).



Телефон: 8 (812) 309-75-97 (многоканальный)

Факс: 8 (812) 320-03-32

Электронная почта: ocean@oceanchips.ru

Web: <http://oceanchips.ru/>

Адрес: 198099, г. Санкт-Петербург, ул. Калинина, д. 2, корп. 4, лит. А