

MIKROE

mikromedia 
CAPACITIVE

USER MANUAL

Thank you for choosing Mikroe!

We present you the ultimate multimedia solution for embedded development.

Elegant on the surface, yet extremely powerful on the inside, we have designed it to inspire outstanding achievements.

And now, it's all yours.

Enjoy premium.

MIKROE
Time saving embedded tools



mikromedia
CAPACITIVE

Micro SD

RST

Heating is active

Living Room

24.6°C

Humidity 12.2%

Lights

Air

Wifi

Appliances

Some of devices are not found

POWER SUPPLY

ETHERNET

BATTERY

RTC

MICRO SD

USB

mikroBUS
Shuttle

MIKROE
ELECTRONICS

mikromedia 7 CAPACITIVE is a compact development board, designed as a complete solution for the rapid development of multimedia and GUI-centric applications. Featuring a large 7" capacitive touch screen driven by a powerful graphics controller that can display a true-color 24-bit color palette [16.7 million colors], DSP-powered embedded sound CODEC IC, MCU Card socket, a set of five compact mikroBUS™ Shuttle connectors, a set of very useful general-purpose sensors and devices, and more, it represents a perfect solution for the rapid development of many different types of applications.

At its core, there is an MCU Card socket which allows mikromedia 7 CAPACITIVE [referred to as "mikromedia 7" in the following text] to use different microcontrollers [MCUs] mounted on a standardized MCU Card, regardless of their vendor or architecture. Although MCU Card standard enables you to place any MCU Card available, to fully use all mikromedia 7 onboard features, MCUs whose pin count is 144 or more are the right choice. This provides a tremendous amount of flexibility, allowing mikromedia 7 to adapt to any specific application requirements, be it a demanding task of displaying fluid and glitch-free multimedia content, or something much simpler.

The mikromedia 7 development board features many connectivity options, including USB, Ethernet, RF, WiFi, CAN [on the MCU Card that supports it] and two 1x26 pin headers. However, five compact-sized mikroBUS Shuttle connectors represent the most distinctive connectivity feature, allowing access to a huge base of Click boards™, growing on a daily basis.

Each section of mikromedia 7 is clearly marked, offering an intuitive and clean interface. Each section contains a single feature [WiFi, RF, MP3...] along with the accompanying components and configuration jumpers. This makes working with the development board much simpler and thus, faster.

The usability of mikromedia 7 doesn't end with its ability to accelerate the prototyping and application development stages: it is designed as a complete solution which can be implemented directly into any project, with no additional hardware modifications required. Four mounting holes [3.2mm/0.126"] at all four corners allow simple installation by using mounting screws. For most applications, a nice stylish casing is all that is needed to turn the mikromedia 7 development board into a fully functional, high-performance, feature-rich design.

1. MCU card

mikromedia 7 development board offers support for various MCU architectures, mounted on a standardized MCU Card **[1]**.

MCU Card contains two 168-pin mezzanine connectors **[2]** that allow interfacing with the development board: one male and one female. Likewise, the mikromedia 7 development board is equipped with a pair of complementary connectors **[3]**, eliminating any possibility of the incorrect orientation, allowing MCU Card to be installed very easily.

Besides these two 168-pin mezzanine connectors, MCU Card may also contain multiplexing circuits, Ethernet PHY ICs, CAN transceivers and connectors, crystal oscillators, clock generators, and other electronic components necessary for the proper operation of the MCU. This makes each MCU Card a self-contained unit, allowing the development board to operate on a logic level, not having to facilitate specific requirements of many different MCUs.

This also allows the MCU to be freely chosen, not having to worry about its pin count, compatibility, and similar issues. Most importantly, it makes swapping between different MCUs during the development phase very simple, without any additional hardware interventions required.

MCU Card must be installed prior to using the mikromedia 7 development board. More information about MCU Cards can be found at the www.mikroe.com/development-boards/mcu-cards

NOTE

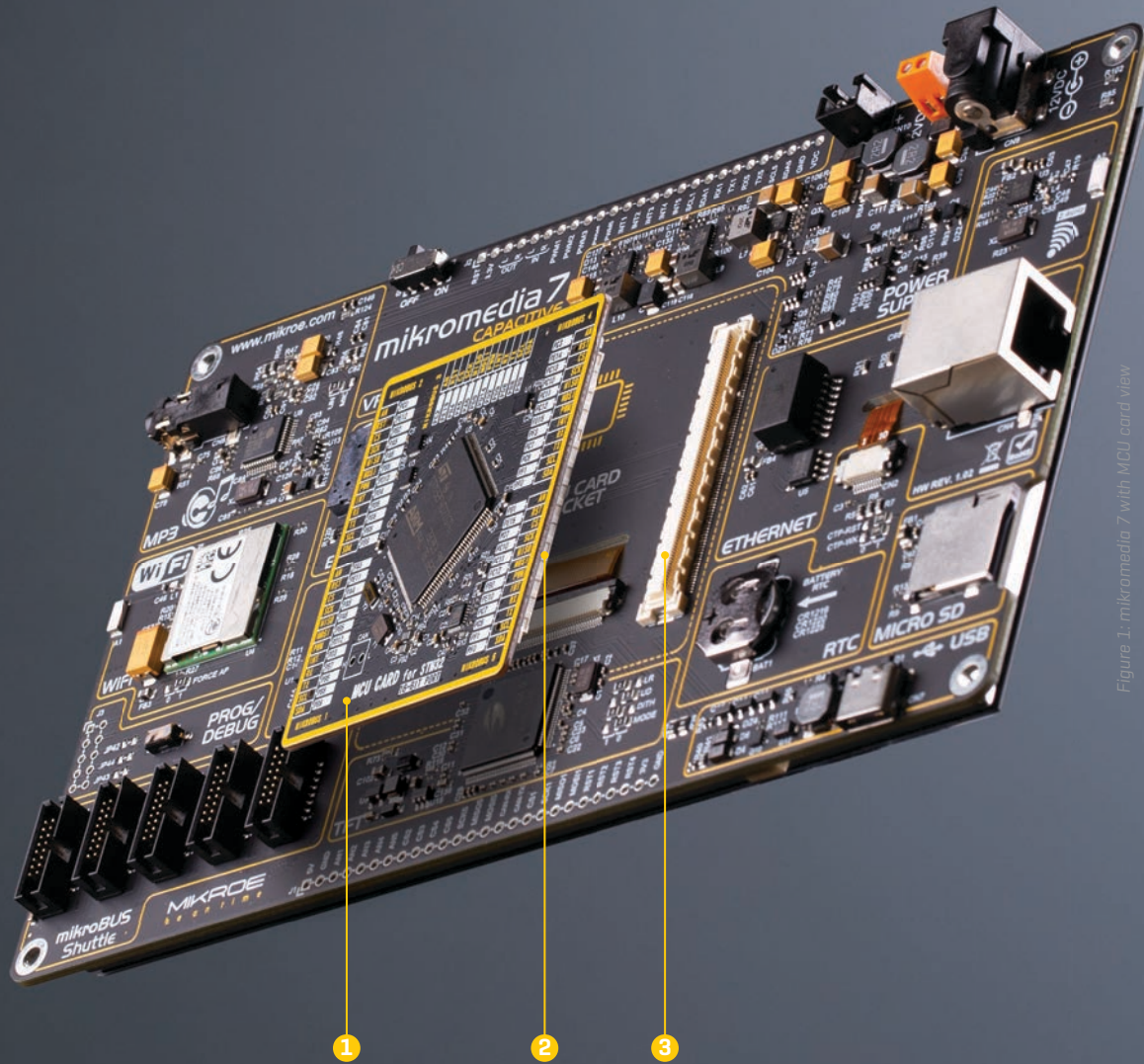
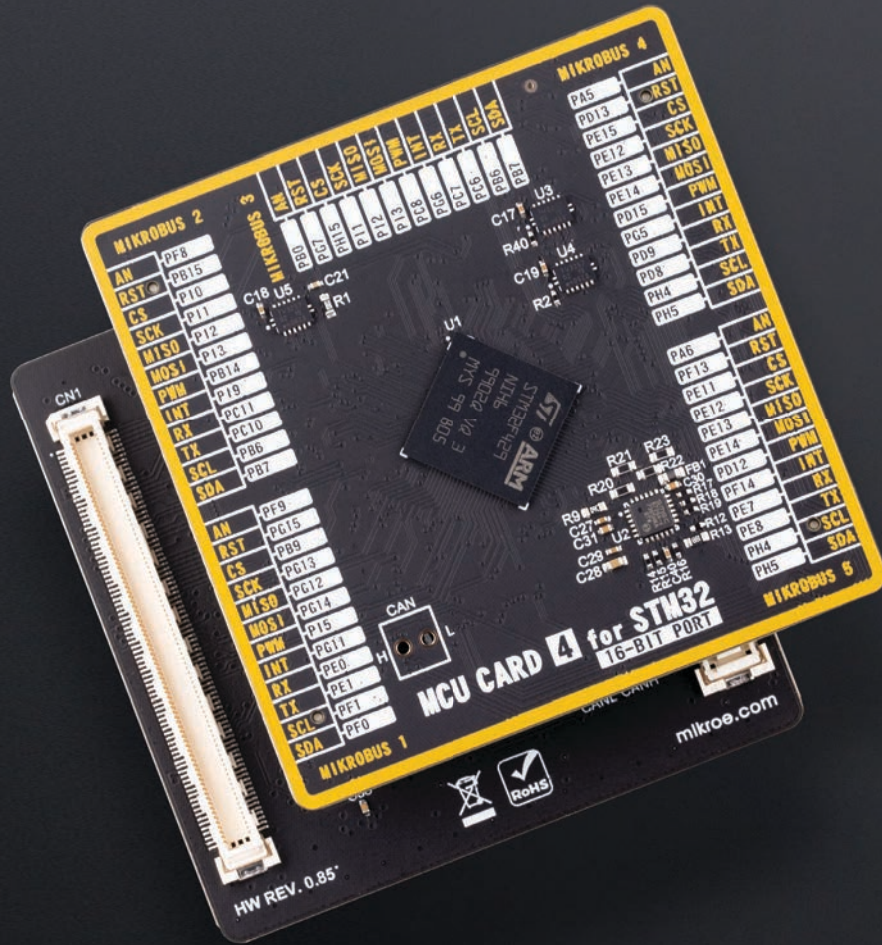

Figure 1. mikromedia 7 with MCU card view



More than **350 MCUs** regardless of their vendor. One **MCU card standard** supports **multiple architectures** ARM, PIC32, dsPIC, PIC, AVR through different vendors: Microchip, ST, NXP, TI and many more yet to come!

www.mikroe.com/development-boards/mcu-cards

Figure 2: Front and back partial view

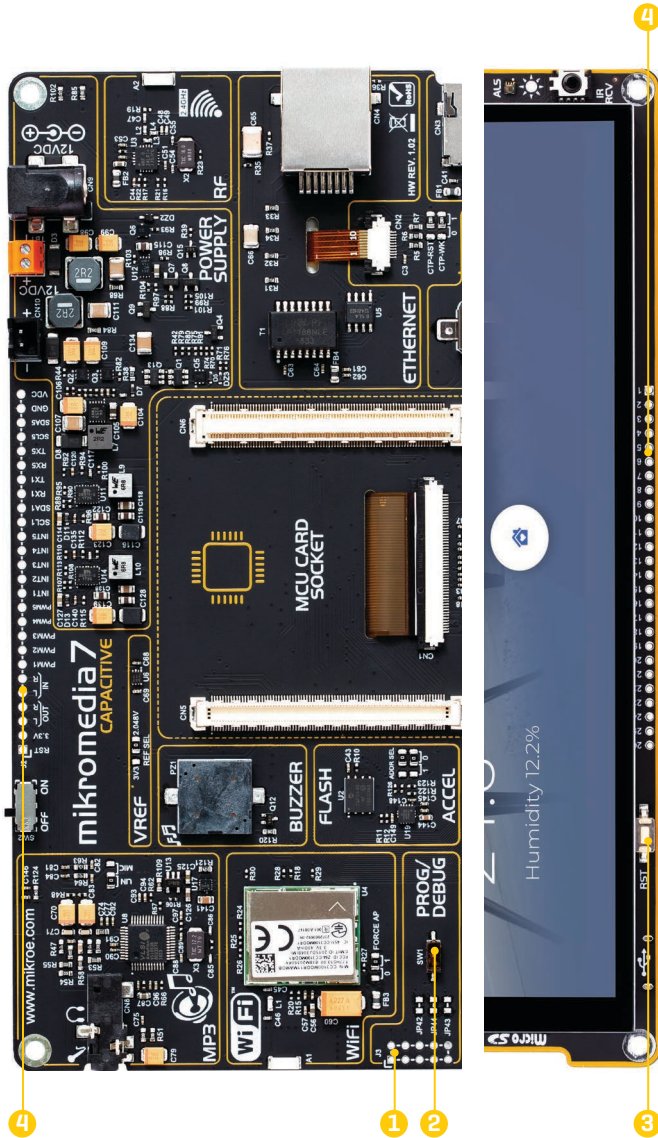

1.1 MCU programming/debugging

The installed MCU (referred to as “host MCU” in the following text) can be programmed and debugged over the JTAG/SWD compatible 2x5 pin header **(1)**, labeled as PROG/DEBUG. This header allows an external programmer (e.g. CODEGRIP or mikroProg) to be used. To enable the JTAG interface, two SMD jumpers labeled as JP42 and JP44, located in the PROG/DEBUG section, have to be populated. These jumpers are unpopulated by default, optimizing the pin count so that more pins could be used for a large number of onboard modules and peripherals. Hence, SWD interface is enabled/supported out of the box.

If your MCU card has preprogrammed bootloader, MCU can be programmed by using the mikrobootloader application. All the information about the bootloader software can be found on the following page: www.mikroe.com/mikrobootloader

A switch labeled as SW1 **(2)** is used to specify whether CODEGRIP/mikroProg or a third-party programmer is connected to the JTAG/SWD header.

SW1 – left position: to use CODEGRIP/mikroProg

SW1 – right position: to use a third-party programmer

Before usage, please check if the programmer pinout and the 2x5 pin header pinout are compatible. Based on the used programmer/debugger tool pinout, a corresponding adapter might be needed (e.g. mikroProg for PIC).

NOTE

1.2 MCU reset

The mikromedia 7 development board is equipped with the reset button labeled as RST **(3)**, located on the front of the board. It is used to generate a LOW logic level on the MCU reset pin. The RST pin of the host MCU is also routed to the pin 1 of the 1x26 pin header **(4)**, allowing an external signal to reset the device.



CODEGRIP
USB/WIRELESS PROGRAMMER & DEBUGGER

MIKROE

- POWER
- USB-LINK
- NET-LINK
- ACTIVE
- DATA

CODEGRIP ADAPT
10-pin 0.10" ARM Cortex Debug

MIKROE

www.mikroe.com

mikromedia 7 CAPACTIVE

VREF 3V3 REF SEL 2.048V C69 U6 C68

MP3

WiFi

WiFi

PROG/
DEBUG

BUZZER

FLASH

ACCEL

MCU CARD for STM32
16-BIT PORT

mikroBUS Shuttle

MIKROE
be on time

MIKROBUS 2

AN	PC0
RST	PE12
CS	PB2
SCK	PA5
MISO	PA6
MOSI	PB5
PWM	PD13
INT	PD4
RX	PD6
TX	PD5
SCL	PB8
SDA	PB9

MIKROBUS 3

AN	PA3
RST	PE11
CS	PA4
SCK	PA5
MISO	PA6
MOSI	PB5
PWM	PD12
INT	PD3
RX	PB7
TX	PB6
SCL	PB8
SDA	PB9

MIKROBUS 4

AN	PC3
RST	PE14
CS	PC13
SCK	PC10
MISO	PC11
MOSI	PC12
PWM	PD15
INT	PF3
RX	PC7
TX	PC6
SCL	PF1
SDA	PFO

MIKROBUS 5

AN	PB1
RST	PE15
CS	PD7
SCK	PC10
MISO	PC11
MOSI	PC12
PWM	PB0
INT	PE10
RX	PC7
TX	PC6
SCL	PF1
SDA	PFO

TFT

SSD19630 AU839AF

LR UD DITH MODE

MP3

U8

U17

U19

U109

U125

U139

U141

U170

U171

U172

U173

U174

U175

U176

U177

U178

U179

U180

U181

U182

U183

U184

U185

U186

U187

U188

U189

U190

U191

U192

U193

U194

U195

U196

U197

U198

U199

U200

U201

U202

U203

U204

U205

U206

U207

U208

U209

U210

U211

U212

U213

U214

U215

U216

U217

U218

U219

U220

U221

U222

U223

U224

U225

U226

U227

U228

U229

U230

U231

U232

U233

U234

U235

U236

U237

U238

U239

U240

U241

U242

U243

U244

U245

U246

U247

U248

U249

U250

U251

U252

U253

U254

U255

U256

U257

U258

U259

U260

U261

U262

U263

U264

U265

U266

U267

U268

U269

U270

U271

U272

U273

U274

U275

U276

U277

U278

U279

U280

U281

U282

U283

U284

U285

U286

U287

U288

U289

U290

U291

U292

U293

U294

U295

U296

U297

U298

U299

U300

U301

U302

U303

U304

U305

U306

U307

U308

U309

U310

U311

U312

U313

U314

U315

U316

U317

U318

U319

U320

U321

U322

U323

U324

U325

U326

U327

U328

U329

U330

U331

U332

U333

U334

U335

U336

U337

U338

U339

U340

U341

U342

U343

U344

U345

U346

U347

U348

U349

U350

U351

U352

U353

U354

U355

U356

U357

U358

U359

U360

U361

U362

U363

U364

U365

U366

U367

U368

U369

U370

U371

U372

U373

U374

U375

U376

U377

U378

U379

U380

U381

U382

U383

U384

U385

U386

U387

U388

U389

U390

U391

U392

U393

U394

U395

U396

U397

U398

U399

U400

U401

U402

U403

U404

U405

U406

U407

U408

U409

U410

U411

U412

U413

U414

U415

U416

U417

U418

U419

U420

U421

U422

U423

U424

U425

U426

U427

U428

U429

U430

U431

U432

U433

U434

U435

U436

U437

U438

U439

U440

U441

U442

U443

U444

U445

U446

U447

U448

U449

U450

U451

U452

U453

U454

U455

U456

U457

U458

U459

U460

U461

U462

U463

U464

U465

U466

U467

U468

U469

U470

U471

U472

U473

U474

U475

U476

U477

U478

U479

U480

U481

U482

U483

U484

U485

U486

U487

U488

U489

U490

U491

U492

U493

U494

U495

U496

U497

U498

U499

U500

U501

U502

U503

U504

U505

U506

U507

U508

U509

U510

U511

U512

U513

U514

U515

U516

U517

U518

U519

U520

U521

U522

U523

U524

U525

U526

U527

U528

U529

U530

U531

U532

U533

U534

U535

U536

U537

U538

U539

U540

U541

U542

U543

U544

U545

U546

U547

U548

U549

U550

U551

U552

U553

U554

U555

U556

U557

U558

U559

U560

U561

U562

U563

U564

U565

U566

U567

U568

U569

U570

U571

U572

U573

U574

U575

U576

U577

U578

U579

U580

U581

U582

U583

U584

U585

U586

U587

U588

U589

U590

U591

U592

U593

U594

U595

U596

U597

U598

U599

U600

U601

U602

U603

U604

U605

U606

U607

U608

U609

U610

U611

U612

U613

U614

U615

U616

U617

U618

U619

U620

U621

U622

U623

U624

U625

U626

U627

U628

U629

U630

U631

U632

U633

U634

U635

U636

U637

U638

U639

U640

U641

U642

U643

U644

U645

U646

U647

U648

U649

U650

U651

U652

U653

U654

U655

U656

U657

U658

U659

U660

U661

U662

U663

U664

U665

U666

U667

U668

U669

U670

U671

U672

U673

U674

U675

U676

U677

U678

U679

U680

U681

U682

U683

U684

U685

U686

U687

U688

U689

U690

U691

U692

U693

U694

U695

U696

U697

U698

U699

U700

U701

U702

U703

U704

U705

U706

U707

U708

U709

U710

U711

U712

U713

U714

U715

U716

U717

U718

U719

U720

U721

U722

U723

U724

U725

U726

U727

U728

U729

U730

U731

U732

U733

U734

U735

U736

U737

U738

U739

U740

U741

U742

U743

U744

U745

U746

U747

U748

U749

U750

U751

U752

U753

U754

U755

U756

U757

U758

U759

U760

U761

U762

U763

U764

U765

U766

U767

U768

U769

U770

U771

U772

U773

U774

U775

U776

U777

U778

U779

U780

U781

U782

U783

U784

U785

U786

U787

U788

U789

U790

U791

U792

U793

U794

U795

U796

U797

U798

U799

U800

U801

U802

U803

U804

U805

U806

U807

U808

U809

U810

U811

U812

U813

U814

U815

U816

U817

U818

U819

U820

U821

U822

U823

U824

U825

U826

U827

U828

U829

U830

U831

U832

U833

U834

U835

U836

U837

U838

U839

U840

U841

U842

U843

U844

U845

U846

U847

U848

U849

U850

U851

U852

U853

U854

U855

U856

U857

U858

U859

U860

U861

U862

U863

U864

U865

U866

U867

U868

U869

U870

U871

U872

U873

U874

U875

U876

U877

U878

U879

U880

U881

U882

U883

U884

U885

U886

U887

U888

U889

U890

U891

U892

U893

U894

U895

U896

U897

U898

U899

U900

U901

U902

U903

U904

U905

U906

U907

U908

U909

U910

U911

U912

U913

U914

U915

U916

U917

U918

U919

U920

U921

U922

U923

U924

U925

U926

U927

U928

U929

U930

U931

U932

U933

U934

U935

U936

U937

U938

U939

U940

U941

U942

U943

U944

U945

U946

U947

U948

U949

U950

U951

U952

U953

U954

U955

U956

U957

U958

U959

U960

U961

U962

U963

U964

U965

U966

U967

U968

U969

U970

U971

U972

U973

U974

U975

U976

U977

U978

U979

U980

U981

U982

U983

U984

U985

U986

U987

U988

U989

U990

U991

U992

U993

U994

U995

U996

U997

U998

U999

U1000

MB1 MB2 MB3 MB4 MB5

TFT

SSD19630 AU839AF

LR UD DITH MODE

MIKROE be on time

5V GND AN1 AN2 AN3 AN4 AN5 CS2 CS3 CS4 CS5 SCK5 MISO5 MOSI5 CAN-RX CAN-TX CS1 SCK1 MISO1 MOSI1 RST1 RST2 RST3 RST4 3.3V GND

2. Power supply unit

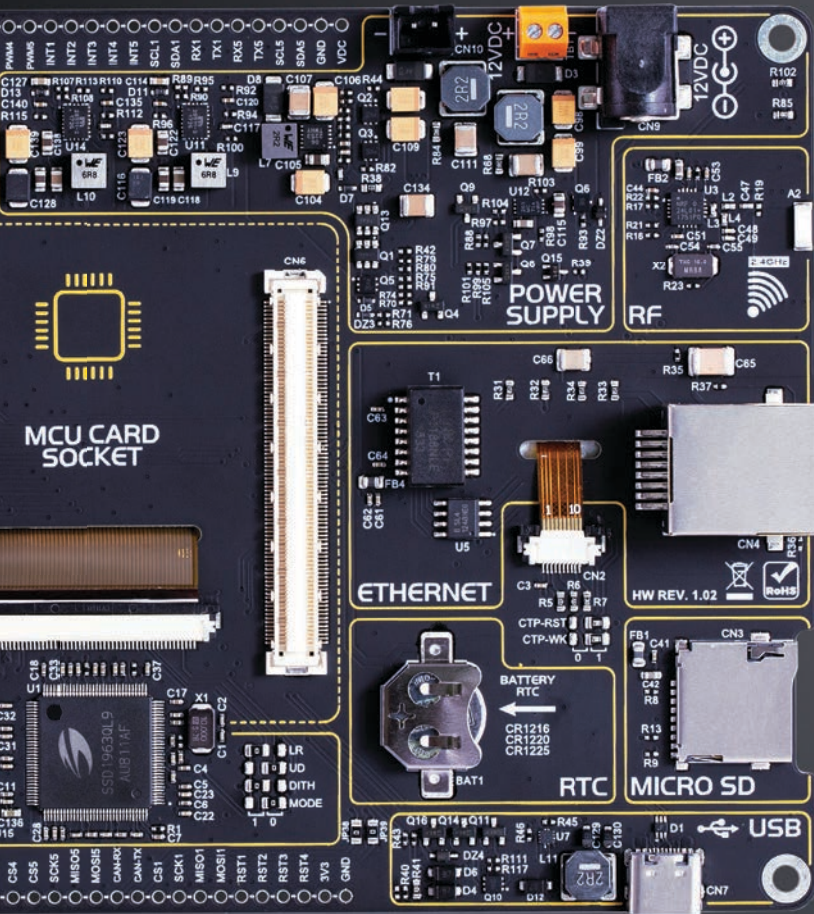

Figure 3: Power supply unit view

The power supply unit [PSU] provides clean and regulated power, necessary for proper operation of the mikromedia 7 development board. The host MCU, along with the rest of the peripherals, demands regulated and noise-free power supply. Therefore, PSU is carefully designed to regulate, filter, and distribute the power to all parts of mikromedia 7. It is equipped with four different power supply inputs, offering all the flexibility that mikromedia 7 needs, especially when used on the field or as an integrated element of a larger system. In the case when multiple power sources are used, an automatic power switching circuit with predefined priorities ensures that the most appropriate will be used.

The PSU also contains a reliable and safe battery charging circuit, which allows a single-cell Li-Po/Li-Ion battery to be charged. Power OR-ing option is also supported providing uninterrupted power supply [UPS] functionality when an external or USB power source is used in combination with the battery.

2.1 Detailed description

The PSU has a very demanding task of providing power for the host MCU and all the peripherals onboard, as well as for the externally connected peripherals. One of the key requirements is to provide enough current, avoiding the voltage drop at the output. Also, the PSU must be able to support multiple power sources with different nominal voltages, allowing switching between them by priority. The PSU design, based on a set of high-performance power switching ICs produced by Microchip, ensures a very good quality of the output voltage, high current rating, and reduced electromagnetic radiation.

At the input stage of the PSU, the MIC2253, a high-efficiency boost regulator IC with overvoltage protection ensures that the voltage input at the next stage is well-regulated and stable. It is used to boost the voltage of low-voltage power sources (a Li-Po/Li-Ion battery and USB), allowing the next stage to deliver well-regulated 3.3V and 5V to the development board. A set of discrete components are used to determine if the input power source requires a voltage boost. When multiple power sources are connected at once, this circuitry is also used to determine the input priority level: externally connected 12V PSU, power over USB, and the Li-Po/Li-Ion battery. The transition between available power sources is designed to provide uninterrupted operation of the development board.

The next PSU stage uses two MIC28511, synchronous step-down (buck) regulators, capable of providing up to 3A. The MIC28511 IC utilizes the HyperSpeed Control® and HyperLight Load® architectures, providing an ultra-fast transient response and high light-load efficiency. Each of the two buck regulators is used to supply power to the corresponding power supply rail (3.3V and 5V), throughout the entire development board and connected peripherals.

2.2 Voltage reference

The MCP1501, a high-precision buffered voltage reference from Microchip is used to provide a very precise voltage reference with no voltage drift. It can be used for various purposes: the most common uses include voltage references for A/D converters, D/A converters, and comparator peripherals on the host MCU. The MCP1501 can provide up to 20mA, limiting its use exclusively to voltage comparator applications with high input impedance. Depending on the specific application, either 3.3V from the power rail, or 2.048V from the MCP1501 can be selected. An onboard SMD jumper labeled as REF SEL, located in a separate section labeled as VREF, offers two voltage reference choices:

- REF: 2.048V from the high-precision voltage reference IC
- 3V3: 3.3V from the main power supply rail

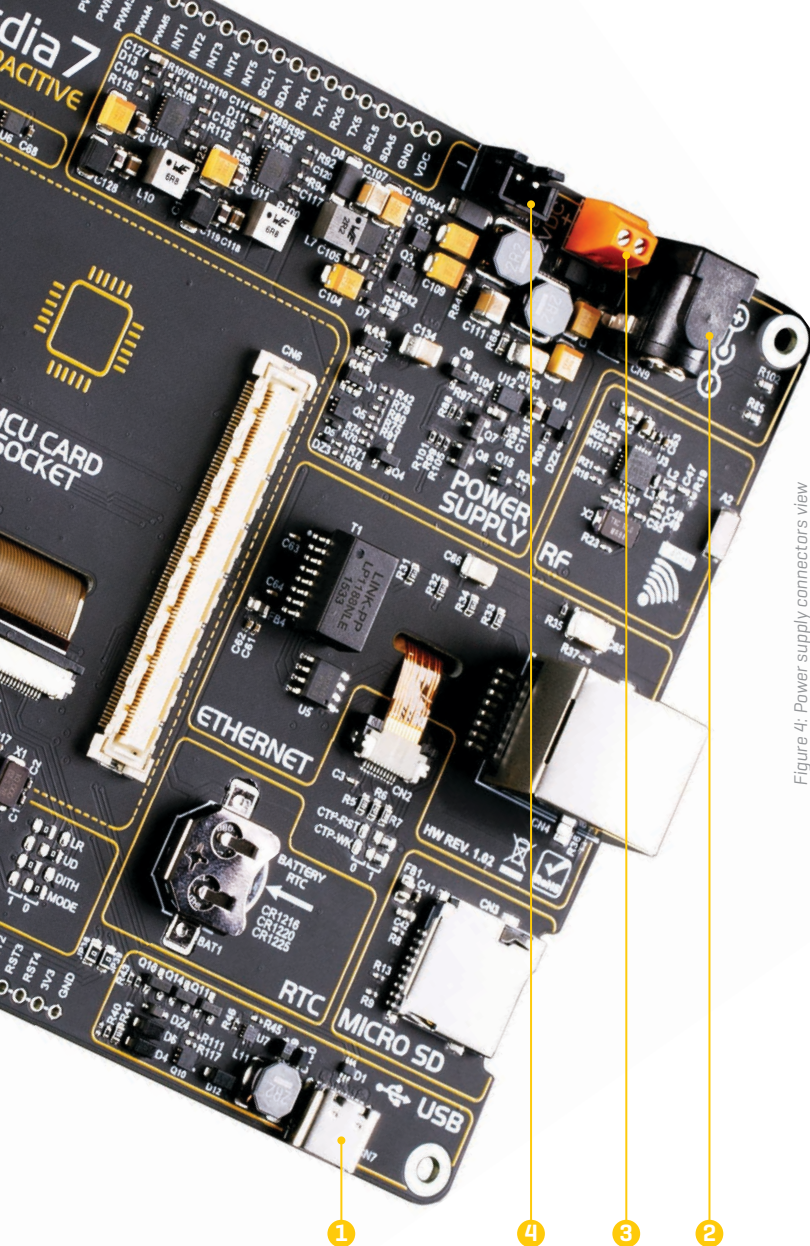

Figure 4: Power supply connectors view

2.3 PSU connectors

As explained, the advanced design of the PSU allows several types of power sources to be used, offering unprecedented flexibility: when powered by a Li-Po/Li-Ion battery, it offers an ultimate degree of autonomy. For situations where the power is an issue, it can be powered by an external 12VDC power supply, connected over the 5.5mm barrel connector or over the two-pole screw terminal. Power is not an issue even if it is powered over the USB cable. It can be powered over the USB-C connector, using power supply delivered by the USB HOST [i.e. personal computer], USB wall adapter, or a battery power bank.

There are four power supply connectors available, each with its unique purpose:

- CN7: USB-C connector **[1]**
- CN9: 12VDC barrel-type connector **[2]**
- TB1: Screw terminal for an external 12VDC PSU **[3]**
- CN10: Standard 2.5mm pitch XH battery connector **[4]**

2.3.1 USB-C connector

The USB-C connector [labeled as CN7] provides power from the USB host [typically PC], USB power bank, or USB wall adapter. When powered over the USB connector, the available power will depend on the source capabilities.

Maximum power ratings, along with the allowed input voltage range in the case when the USB power supply is used, are given in the table below:

USB Power Supply				
Input Voltage [V]		Output Voltage [V]	Max Current [A]	Max Power [W]
MIN	MAX	3.3	1.8	5.94
4.4	5.5	5	1.4	7
		3.3 & 5	0.8 & 0.8	6.64

Figure 5: USB power supply table

When using a PC as the power source, the maximum power can be obtained if the host PC supports the USB 3.2 interface, and is equipped with USB-C connectors. If the host PC uses the USB 2.0 interface, it will be able to provide the least power, since only up to 500 mA [2.5W at 5V] is available in that case. Note that when using longer USB cables or USB cables of low quality, the voltage may drop outside the rated operating voltage range, causing unpredictable behavior of the development board.

NOTE If the USB host is not equipped with the USB-C connector, a Type A to Type C USB adapter may be used [included in the package].

2.3.2 12VDC barrel-type connector and screw terminal

An external 12V power supply can be connected over the 12VDC barrel connector [labeled as CN9] or over the 2-pole screw terminal [labeled

as TB1]. When using an external power supply, it is possible to obtain an optimal amount of power, since one external power supply unit can be easily exchanged with another, while its power and operating characteristics can be decided per application. The development board allows a current of 2.8A per power rail [3.3V and 5V] when using an external 12V power supply. The barrel-type connector is useful for connecting wall-adapters, while the screw terminal is a good choice when there is no connector installed at the end of the PSU cable.

NOTE 12V barrel-type connector and screw terminal should not be used simultaneously by two different power supplies, as the connectors are routed in parallel.

Maximum power ratings, along with the allowed input voltage range in the case when the external power supply is used, are given in the table below:

External Power Supply				
Input Voltage [V]		Output Voltage [V]	Max Current [A]	Max Power [W]
MIN	MAX	3.3	2.8	9.24
10.6	14	5	2.8	14
		3.3 & 5	2.8 & 2.8	23.24

Figure 6: External power supply table

NOTE When connecting an external power supply over the barrel connector, make sure that the polarity of the barrel connector is matched with the 12VDC connector on the development board, according to the image printed on the front side, above the connector itself.

2.3.3 Li-Po/Li-Ion XH battery connector

When powered by a single-cell Li-Po/Li-Ion battery, mikromedia 7 offers an option to be operated remotely. This allows complete autonomy, allowing it to be used in some very specific situations: hazardous environments, agricultural applications, etc.

The battery connector is a standard 2.5mm pitch XH connector. It allows a range of single-cell Li-Po and Li-Ion batteries to be used. The PSU of mikromedia 7 offers the battery charging functionality, from both the USB connector and the 12VDC/external power supply. The battery charging circuitry of the PSU manages the battery charging process, allowing the optimal charging conditions and longer battery life. The charging process is indicated by BATT indicator, located on the front of mikromedia 7.

The PSU module also includes the battery charger circuit. Depending on the operational status of the mikromedia 7 development board, the charging current can be either set to 100mA or 500mA. When the development board is powered OFF, the charger IC will allocate all available power for the battery charging purpose. This results in faster charging, with the charging current set to approximately 500mA. While powered ON, the available charging current will be set to approximately 100 mA, reducing the overall power consumption to a reasonable level.

NOTE Using low-quality USB hubs, and too long or low-quality USB cables, may cause a significant USB voltage drop, which can obstruct the battery charging process.

Maximum power ratings along with the allowed input voltage range when the battery power supply is used, are given in the table below:

Battery Power Supply				
Input Voltage [V]		Output Voltage [V]	Max Current [A]	Max Power [W]
MIN	MAX	3.3	1.6	5.28
3.5	4.2	5	1.2	6
		3.3 & 5	0.7 & 0.7	5.81

Figure 7: Battery power supply table

2.4 Power redundancy and uninterrupted power supply (UPS)

The PSU module supports power supply redundancy: it will automatically switch to the most appropriate power source if one of the power sources fails or becomes disconnected. The power supply redundancy also allows for an uninterrupted operation [i.e. UPS functionality, the battery will still provide power if the USB cable is removed, without resetting mikromedia 7 during the transition period].



2.5 Powering up the mikromedia 7 board

After a valid power supply source is connected **[1]**, mikromedia 7 can be powered ON. This can be done by a small switch at the edge of the board, labeled as SW2 **[2]**. By switching it ON, the PSU module will be enabled, and the power will be distributed throughout the board. A LED indicator labeled as PWR indicates that the mikromedia 7 is powered ON.

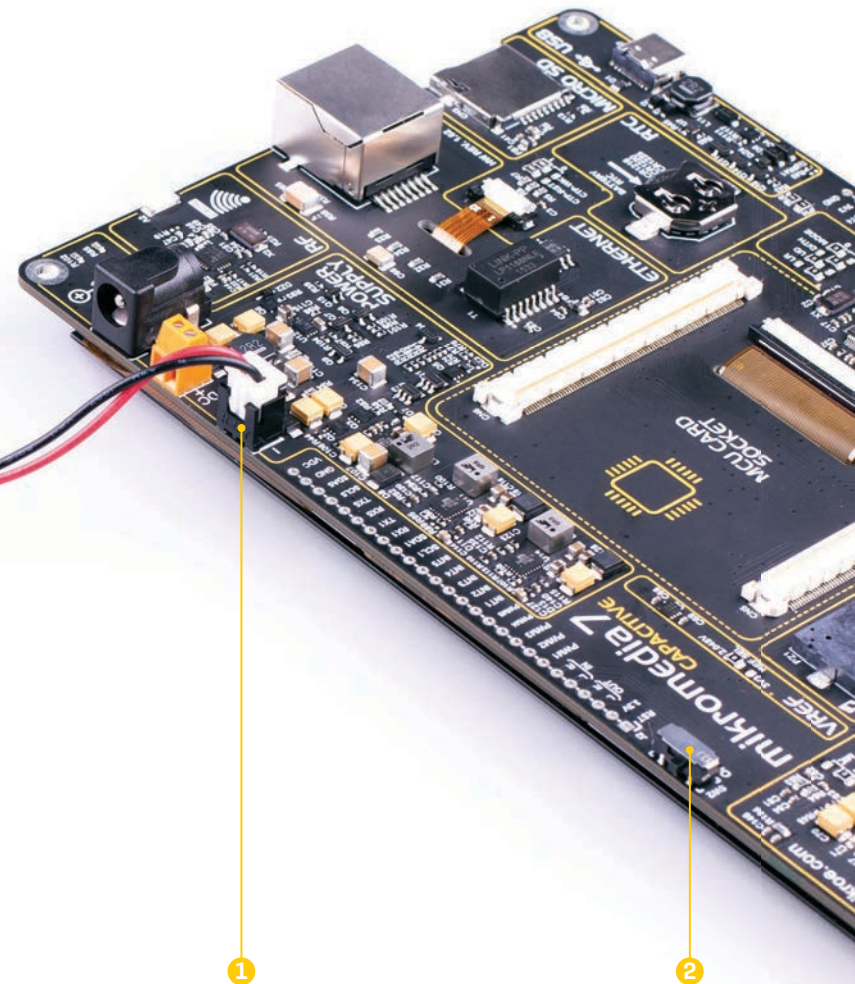

Figure 8: Battery power supply connection view

3. Capacitive display

A high-quality 7" TFT true-color display with a capacitive touch panel is the most distinctive feature of the mikromedia 7. The display has a resolution of 800 by 480 pixels, and it can display a true-color palette of 16.7M of colors [24-bit color depth]. The display of mikromedia 7 features a reasonably high contrast ratio of 500:1, and brightness intensity of 420 Cd/m², thanks to a matrix of 9 x 3 high-brightness LEDs [27 in total] that are used for backlighting.

The display module is controlled by the SSD1963 graphics driver IC from Solomon Systech [1]. This is a powerful graphics coprocessor, equipped with 1215KB of frame buffer memory. It also includes some advanced features such as the hardware accelerated display rotation, display mirroring, hardware windowing, dynamic backlight control, programmable color and brightness control, and more.

Some of the display hardware options can be configured by using SMD jumpers, located in the TFT section [2] of the development board:

LR: Left/Right sequence control of source driver

UD: Up/Down sequence control of gate driver

DITH: Dithering function enable/disable

MODE: DE/SYNC mode select

Please note that the default settings match those in Mikroe software toolchain, so it is not recommended to change them from defaults.

The capacitive multi-touch panel based on the FT5426 CTP controller, allows the development of interactive applications, offering a touch-driven control interface. The touch panel controller uses the I2C interface for the communication with the host MCU. This advanced multi-touch panel controller supports gestures, including zoom and swipe in all four directions.

Equipped with high-quality 7" display [3] and the multi-touch controller that supports gestures, mikromedia 7 represents a very powerful hardware environment for building various GUI-centric Human Machine Interface [HMI] applications.

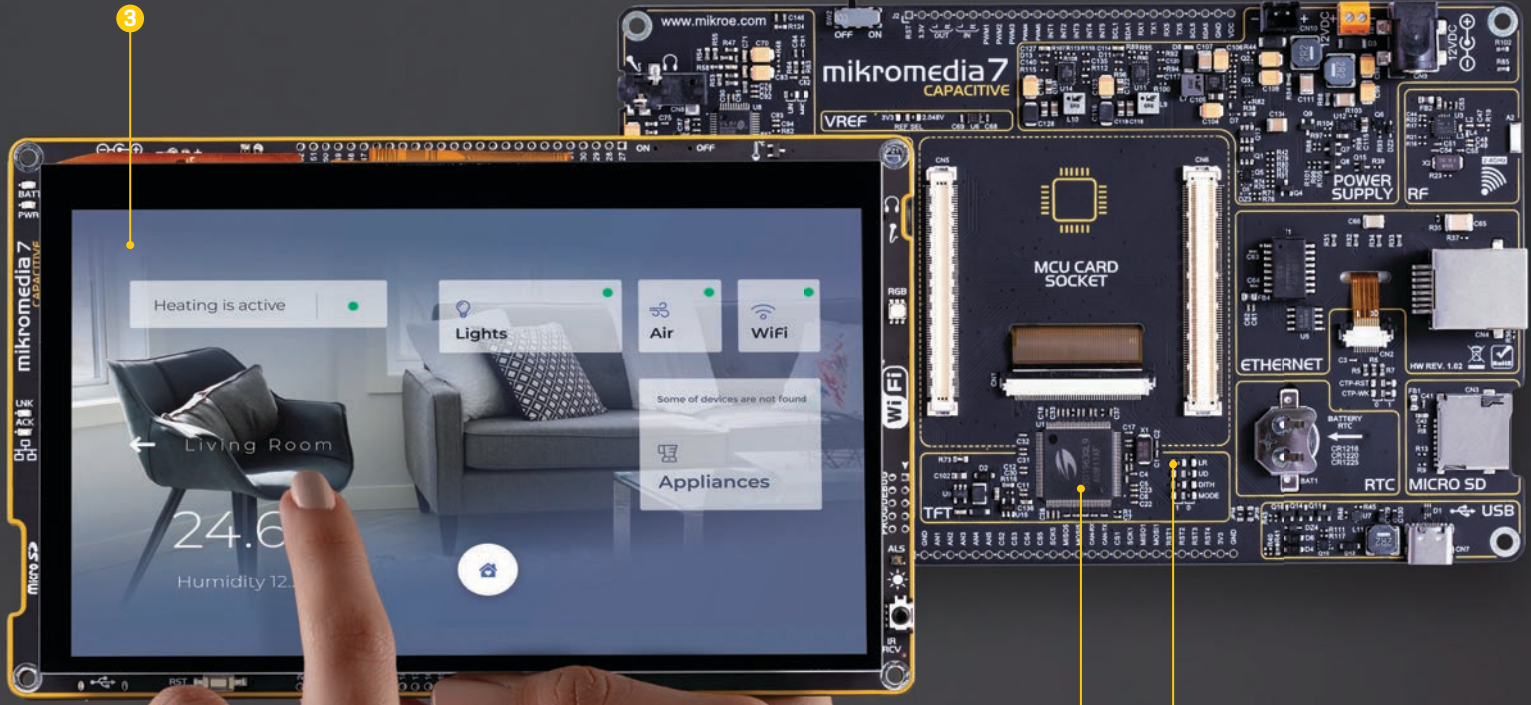

1 2 Figure 9: Display and TFT section view

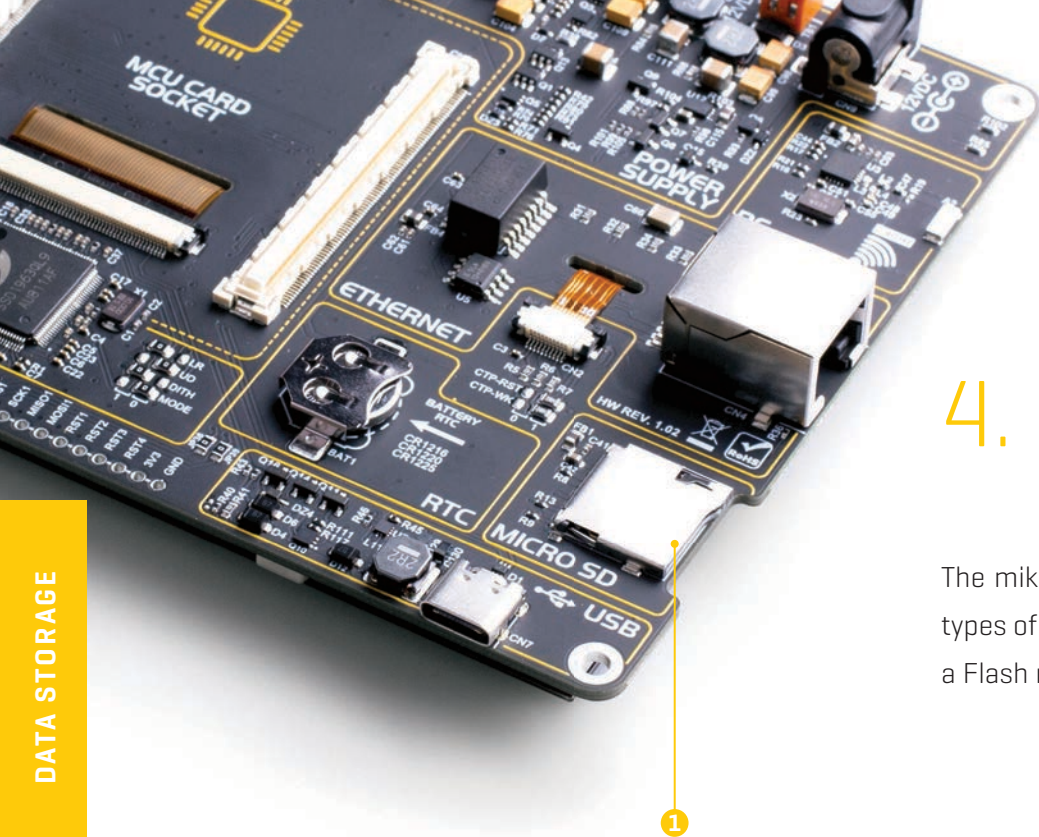

Figure 10: microSD card slot view

4. Data storage

The mikromedia 7 development board is equipped with two types of external memory: with a microSD card slot, and with a Flash memory module.

4.1 microSD card slot

The microSD card slot **[1]** allows storing large amounts of data externally, on a microSD memory card. It uses the Serial Peripheral Interface (SPI) for communication with the MCU. The microSD card detection circuit is also provided on the board. The microSD card is the smallest SD Card version, measuring only 5 x 11 mm. Despite its small size, it allows tremendous amounts of data to be stored on it. In order to read and write to the SD Card, a proper software/firmware running on the host MCU is required.

4.2 External flash storage

mikromedia 7 is equipped with the SST26VF064B Flash module **[2]**. The Flash memory module has a density of 64 Mbits. Its storage cells are arranged in 8-bit words, resulting in 8Mb of non-volatile memory in total, available for various applications. The most distinctive features of the SST26VF064B Flash module are its high speed, very high endurance, and very good data retention period. It can withstand up to 100,000 cycles, and it can preserve the stored information for more than 100 years. It also uses the SPI interface for communication with the host MCU.

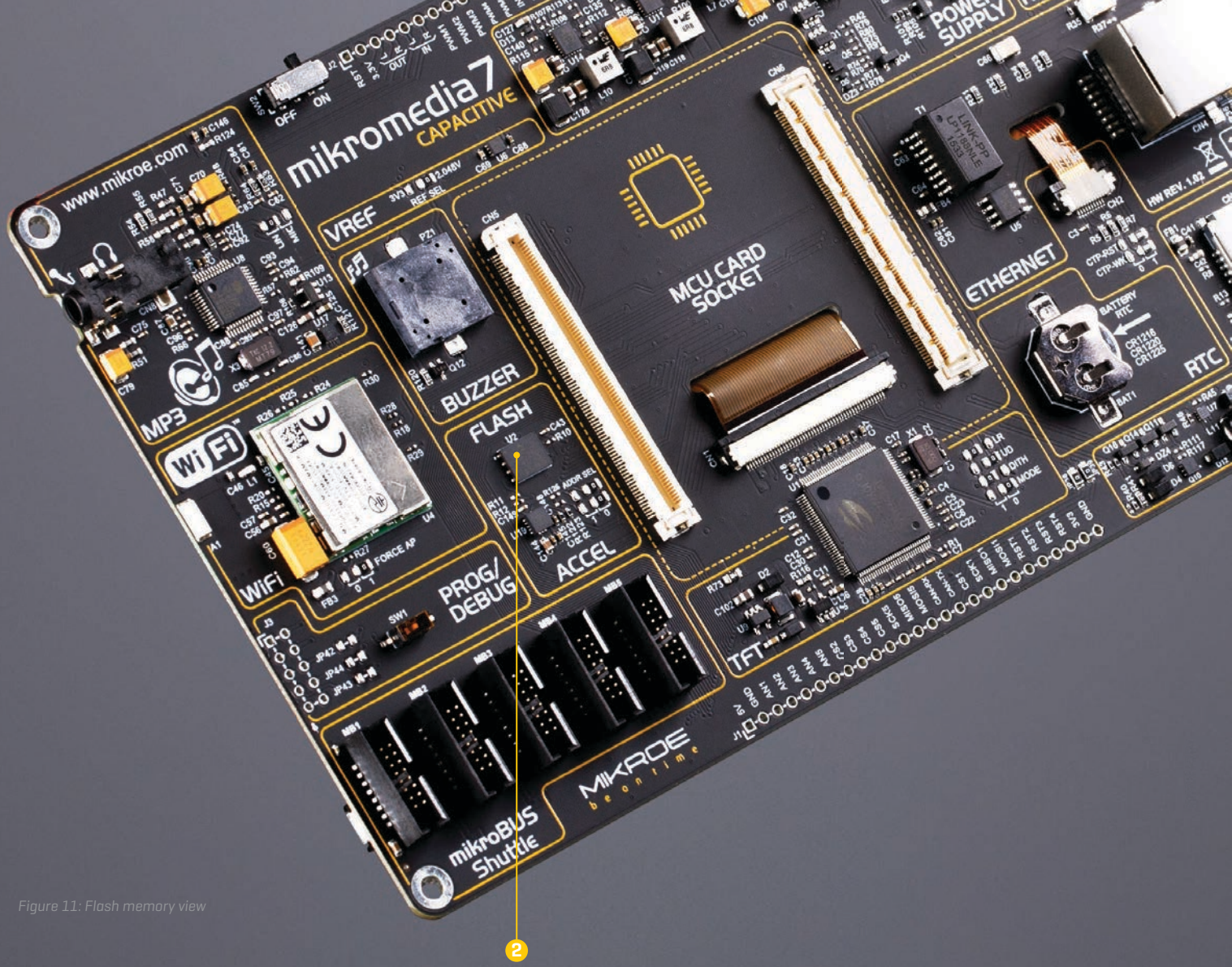
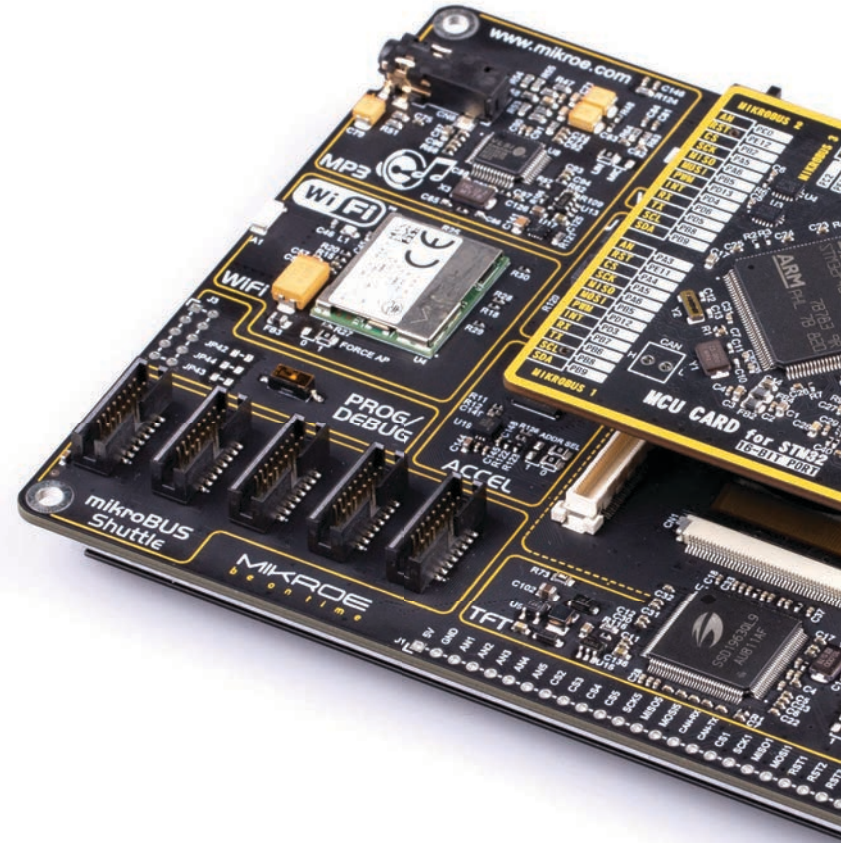

Figure 11: Flash memory view

2

5. Connectivity

mikromedia 7 offers a huge number of connectivity options including USB [HOST/DEVICE], Ethernet, RF and WiFi. The mikromedia 7 development board also offers two 1x26 pin headers, which are used to directly access the host MCU pins. Superior connectivity features of the mikromedia 7 development system are rounded up with five standardized mikroBUS™ Shuttle connectors. It is a considerable upgrade for the system, as it allows interfacing with the huge base of Click boards™.



5.1 Ethernet

Ethernet is a popular computer networking technology for local area networks (LAN). Systems communicating over Ethernet divide a stream of data into individual packets, known as frames. Each frame contains source and destination addresses and error-checking data so that damaged data can be detected and re-transmitted. This makes the Ethernet protocol very popular for communication over longer distances or in noisy environments.

Some MCUs feature an integrated Ethernet peripheral module, which contains the entire communication stack on the chip. MCU Cards equipped with such MCUs, are already provided with the Ethernet physical layer transceiver IC (PHY IC). This allows the Ethernet circuit of the mikromedia 7 development board to be reduced only to isolation transformers/chokes, a pack of TVS diodes for electrostatic discharge (ESD) protection, and an RJ-45 connector **[1]**, allowing the development board to be safely and reliably connected to the Ethernet network. Two LED indicators, labeled as LNK and ACK located on the front side of the board, are used to signal the Ethernet network status and data traffic.

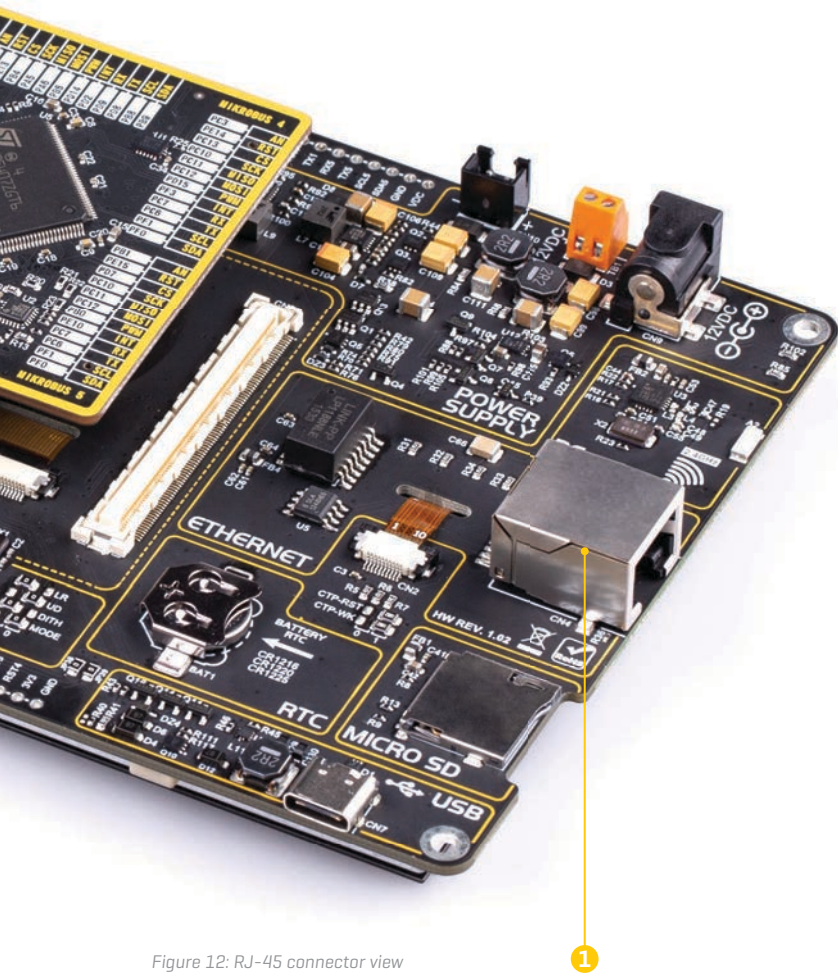

Figure 12: RJ-45 connector view

5.2 WiFi

A very popular WiFi module **[1]** labeled as CC3100 allows WiFi connectivity. This module is the complete WiFi solution on a chip: it is a powerful WiFi network processor with the power management subsystem, offering the TCP/IP stack, powerful crypto engine with 256-bit AES support, WPA2 security, SmartConfig™ technology, and much more.

By offloading the WiFi and Internet handling tasks from the MCU, it allows the host MCU to process more demanding graphical applications, thus making it an ideal solution for adding WiFi connectivity to mikromedia 7. It uses the SPI interface to communicate with the host MCU, along with several additional GPIO pins used for the reset, hibernation, and for the interrupt reporting.

An SMD jumper labeled as FORCE AP **[2]** is used to force the CC3100 module into an Access Point (AP) mode, or into a Station mode. However, the operating mode of the CC3100 module can be overridden by the software. This SMD jumper offers two choices:

- 0:** the FORCE AP pin is pulled to a LOW logic level, forcing the CC3100 module into the STATION mode
- 1:** the FORCE AP pin is pulled to a HIGH logic level, forcing the CC3100 module into the AP mode

There is a chip antenna **[3]** integrated on the PCB of the mikromedia 7, so no additional hardware is required in order to establish the connection over the WiFi network.

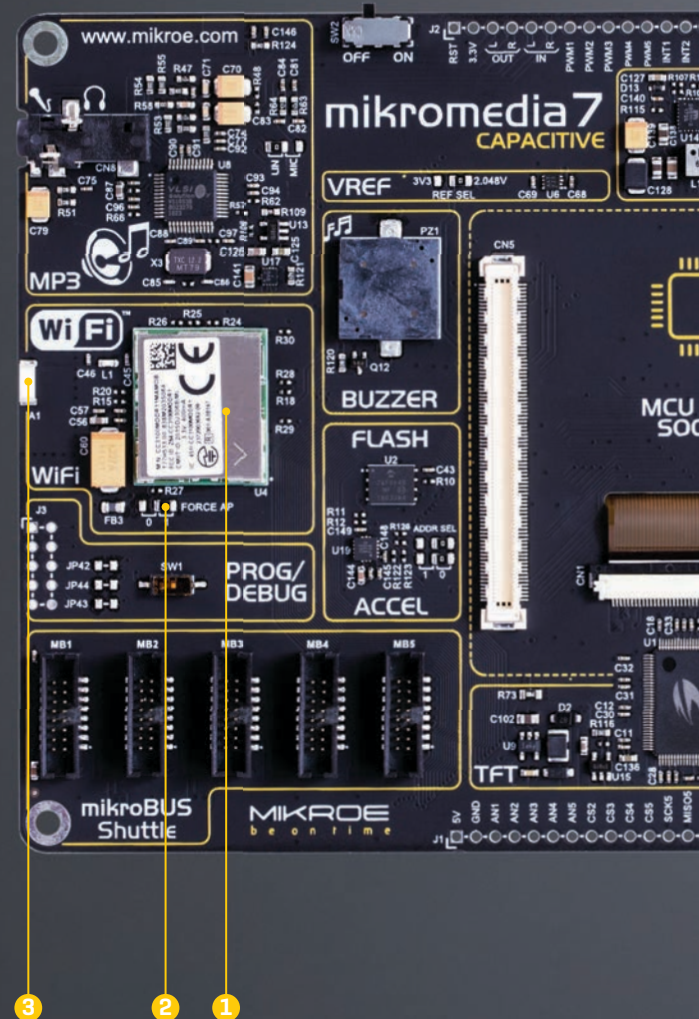

5.3 RF

mikromedia 7 offers communication over the world-wide ISM radio frequency (RF) band. The ISM band covers a frequency range between 2.4GHz and 2.4835GHz. This RF band is reserved for industrial, scientific, and medical use [hence the ISM abbreviation]. In addition, it is globally available, making it a perfect alternative to WiFi, when the M2M communication over a short distance is required.

mikromedia 7 uses the **nRF24L01+ (4)**, a single-chip 2.4GHz transceiver with an embedded baseband protocol engine, produced by Nordic Semiconductors. It is a perfect solution for ultra-low power wireless applications. This transceiver relies on the GFSK modulation, allowing data rates in the range from 250 kbps, up to 2 Mbps. The GFSK modulation is the most efficient RF signal modulation scheme, reducing the required bandwidth, thus being more efficient. The nRF24L01+ also features the proprietary **Enhanced ShockBurst™**, a packet-based data link layer. Besides other functionalities, it offers a 6-channel **MultiCeiver™** feature, which allows using the nRF24L01+ in a star network topology. The nRF24L01+ uses the SPI interface to communicate with the host MCU. Besides the SPI lines, it uses additional GPIO pins for the SPI Chip Select, Chip Enable, and for the interrupt. The RF section of the mikromedia 7 also features a small chip antenna **(5)**, reducing the need for additional hardware components.

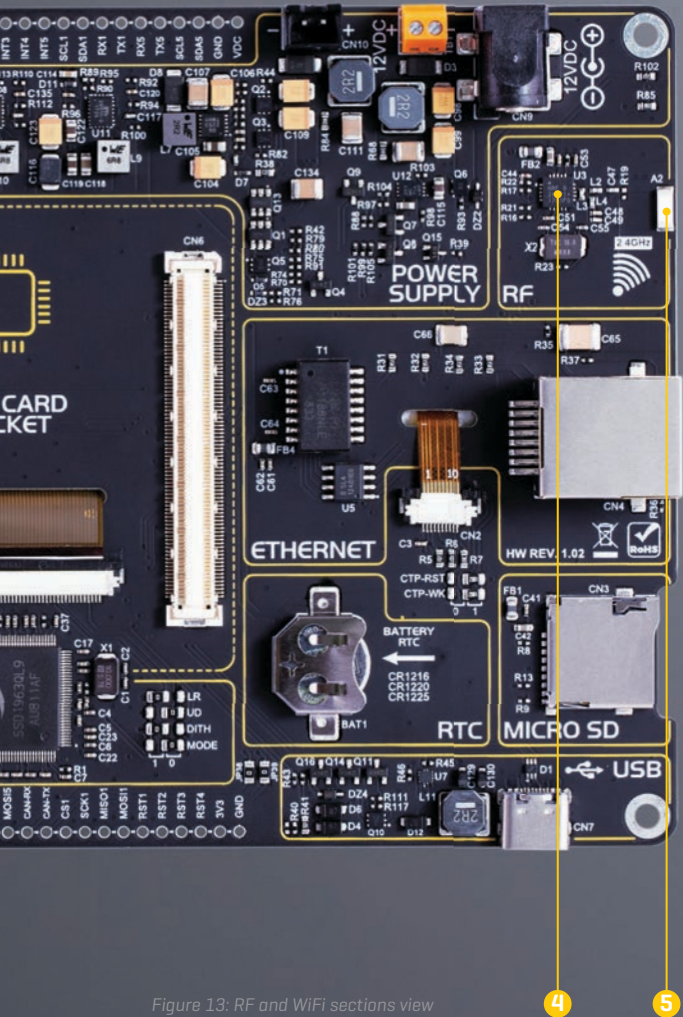

Figure 13: RF and WiFi sections view

5.4 USB

The host MCU is equipped with the USB peripheral module, allowing simple USB connectivity. USB (Universal Serial Bus) is a very popular industry standard that defines cables, connectors, and protocols used for communication and power supply between computers and other devices. Mikromedia 7 supports USB as HOST and USB as DEVICE, allowing the development of a wide range of various USB-based applications. It is equipped with the USB-C connector [1], which offers many advantages, compared to earlier types of USB connectors [symmetrical design, higher current rating, compact size, etc].

The USB mode selection is done using a monolithic controller IC. This IC provides Configuration Channel [CC] detection and indication functions. To set up mikromedia 7 as a USB HOST, the USB PSW pin should be set to a LOW logic level [0] by the host MCU. If set to a HIGH logic level [1], mikromedia 7 acts as a DEVICE. While in HOST mode, mikromedia 7 provides power over the USB-C connector. The USB PSW pin is driven by the host MCU, allowing the software to control the USB mode.

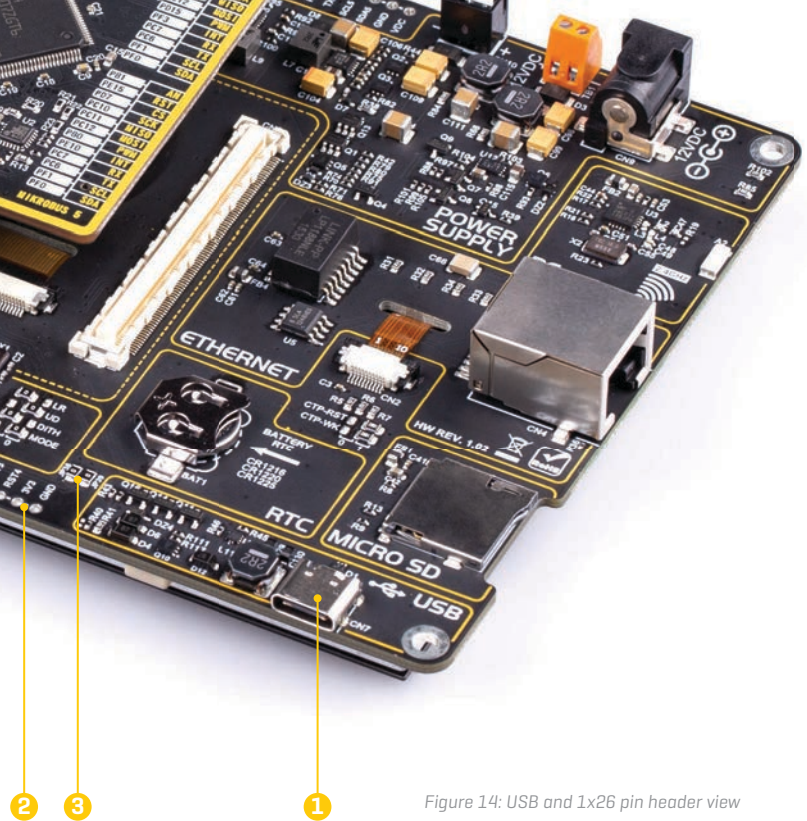

Figure 14: USB and 1x26 pin header view

The USB ID pin is used to detect the type of the device attached to the USB port, according to the USB OTG specifications: the USB ID pin connected to GND indicates a HOST device, while the USB ID pin set to a high impedance state [HI-Z] indicates that the connected peripheral is a DEVICE.

When mikromedia 7 is working in USB HOST mode, it must not be mounted to another USB HOST [such as PC].

NOTE

5.5 CAN

Although not included on the mikromedia 7 development board, CAN bus connectivity can be added as a bonus feature, if the MCU on the installed MCU Card supports it. Similarly to Ethernet, components related to the CAN communication (i.e. CAN transceiver IC) are already included on such MCU Card, along with a small 2-pole screw connector. This allows mikromedia 7 to be used for the CAN communication without any additional hardware modifications required.

Besides the CAN circuit on the MCU Card itself, CAN communication lines are routed to the 1x26 pin header, allowing them to be used with an external CAN transceiver. There are two SMD jumpers near this header [JP38 and JP39] [3], which allow restricting these lines to the MCU Card only. If these SMD jumpers are populated, CAN RX and CAN TX lines of the host MCU will also become available over the 1x26 pin header. The jumpers are populated by default.

Once the external CAN transceiver is connected to CAN-RX and CAN-TX on the 1x26 pin header, CAN jumpers on MCU Card have to be removed (for details check the schematic of the used MCU Card). Similarly, if the CAN transceiver on the MCU Card is to be used, JP38 and JP39 on the mikromedia 7 have to be removed if external CAN transceiver is connected to CAN-RX and CAN-TX pins on the 1x26 pin header. If there is no external CAN transceiver connected to pin header then CAN transceiver on the MCU Card can be used without removing JP38 and JP39.

NOTE CAN transceiver can not be used at the same time on the MCU card and on the 1x26 pin headers.

5.6 1x26 pin headers

Most of the host MCU pins are routed to two 1x26 pin headers [2], making them available for further connectivity. In addition to MCU pins, some additional peripheral pins are also routed to this header. Besides the ability to connect various external devices and peripherals by using wire jumpers, these pins also allow using shields with additional mikroBUS™ sockets, or some other peripherals.

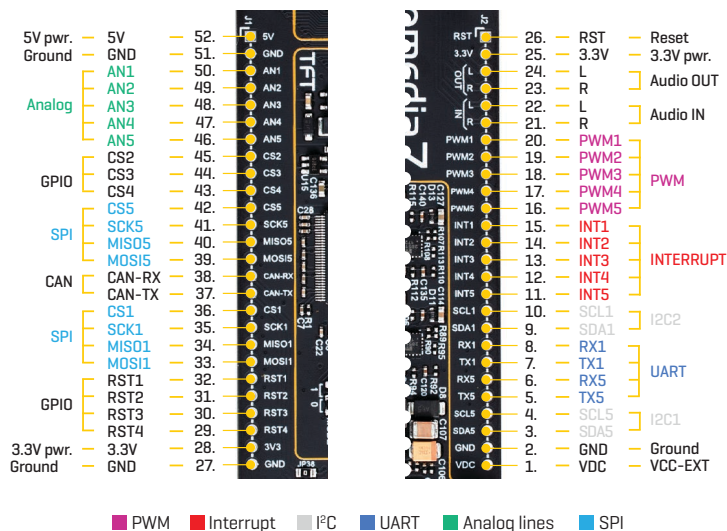

Figure 15: 1x26 pin header view

5.7 mikroBUS™ shuttle connector

Mikromedia 7 is the first development board made in the world that uses the mikroBUS™ Shuttle connector, a brand new addition to the mikroBUS™ standard in the form of a 2x8 pin IDC header with 1.27mm [50mil] pitch. Unlike mikroBUS™ sockets, mikroBUS™ Shuttle connectors take up much less space, allowing them to be used in cases where more compact design is required. There are five mikroBUS™ Shuttle connectors [1] on the development board, labeled from MB1 to MB5.

Typically, a mikroBUS™ Shuttle connector can be used in combination with mikroBUS™ Shuttle extension board but is not limited to it.

mikroBUS™ Shuttle extension board [3] is an add-on board equipped with the conventional mikroBUS™ socket and four mounting holes. It can be connected to the mikroBUS™ Shuttle connector by a flat cable. This ensures compatibility with the huge base of Click boards™. Using mikroBUS™ Shuttles also provides a number of additional benefits:

- When using flat cables, the position of mikroBUS™ Shuttle is not fixed
- mikroBUS™ Shuttle extension boards contain additional mounting holes for permanent installation
- An arbitrary length of flat cables may be used [depending on the particular use cases]
- Connectivity can be additionally expanded, by cascading these connectors using Shuttle click [2]

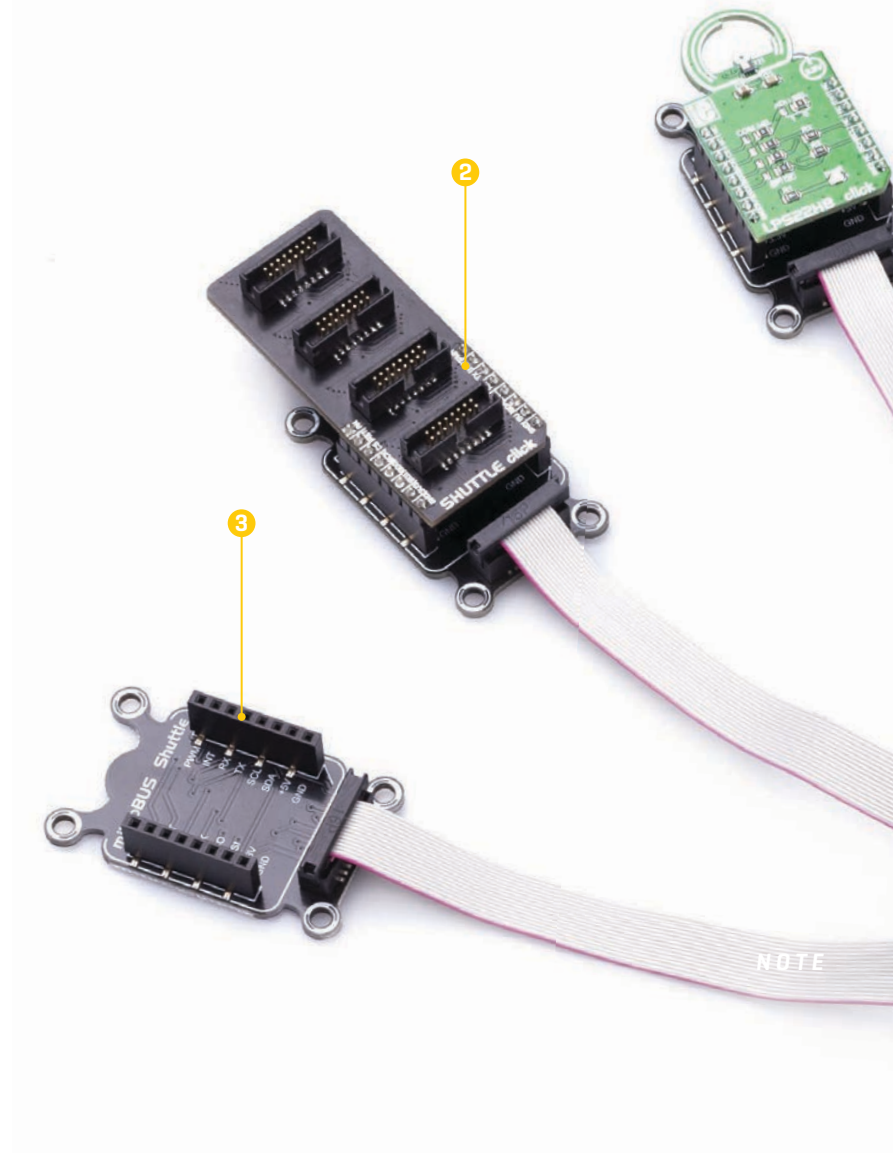

For more information about mikroBUS™ Shuttle extension board and Shuttle click, please visit web pages:

www.mikroe.com/mikrobus-shuttle

www.mikroe.com/shuttle-click

For additional information about the mikroBUS™, please visit the official web page at www.mikroe.com/mikrobus

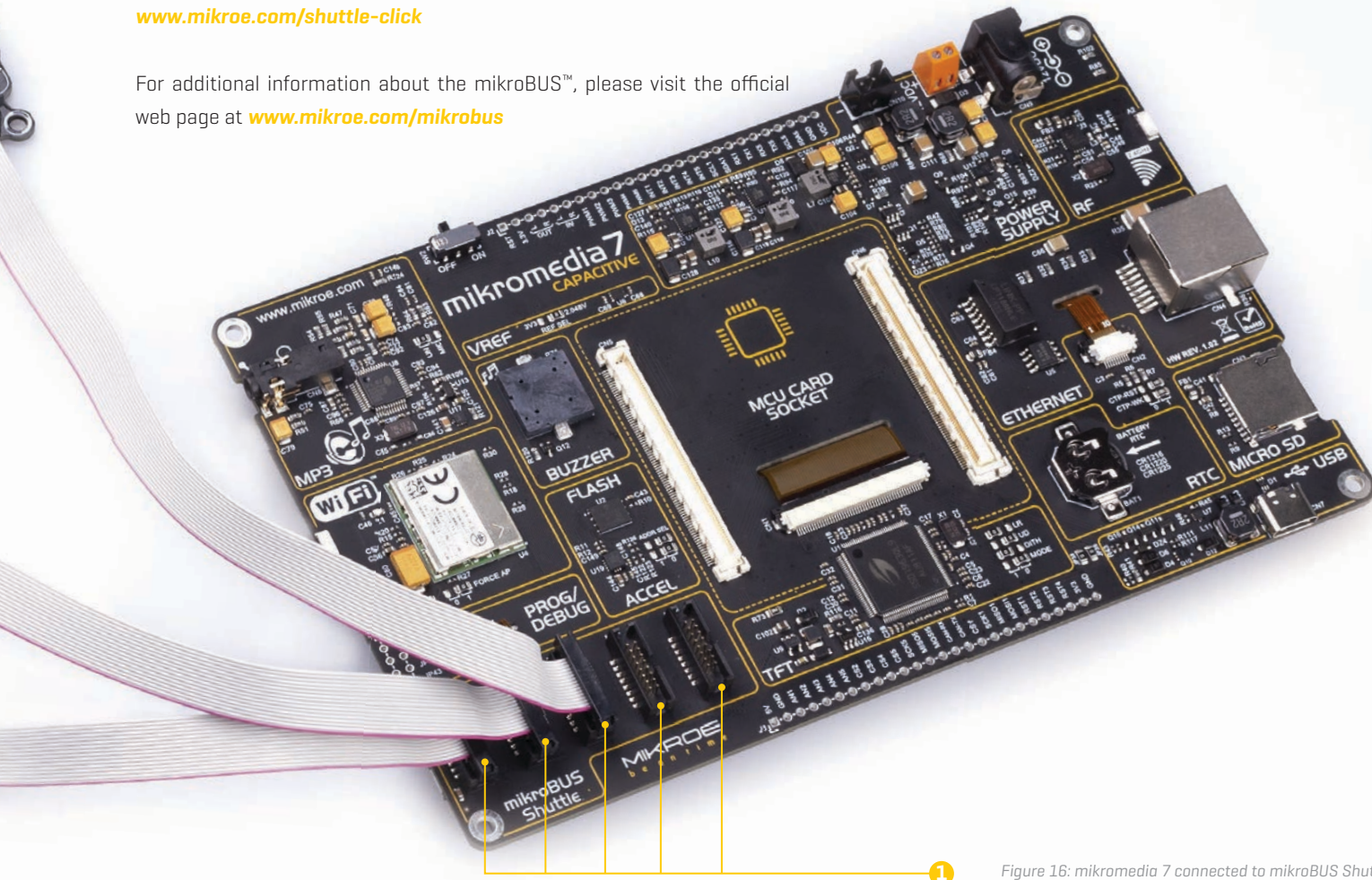

1

Figure 16: mikromedia 7 connected to mikroBUS Shuttle view

6. Sound-related peripherals

By offering a pair of sound-related peripherals, mikromedia 7 rounds-up its multimedia concept. It features a piezo-buzzer, which is extremely easy to program but can produce only the simplest sounds, useful only for alarms or notifications. The second audio option is the powerful VS1053B IC. It is an Ogg Vorbis/MP3/AAC/WMA/FLAC/WAV/MIDI audio decoder, and a PCM/IMA ADPCM/Ogg Vorbis encoder, both on a single chip. It features a powerful DSP core, high-quality A/D and D/A converters, stereo headphones driver capable of driving a 30Ω load, zero-cross detection with the smooth volume change, bass and treble controls, and much more.

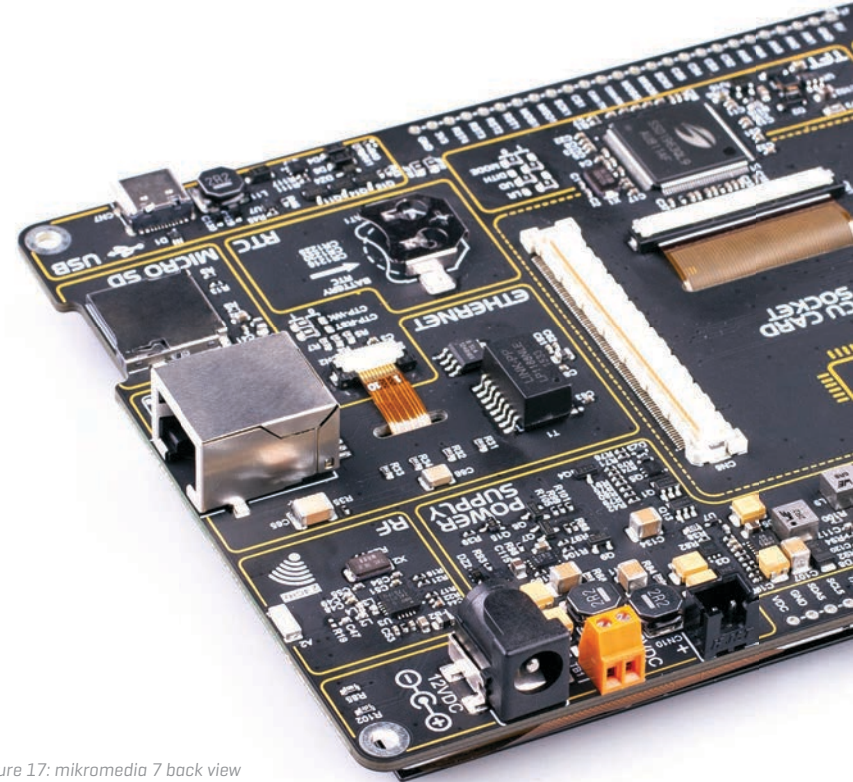
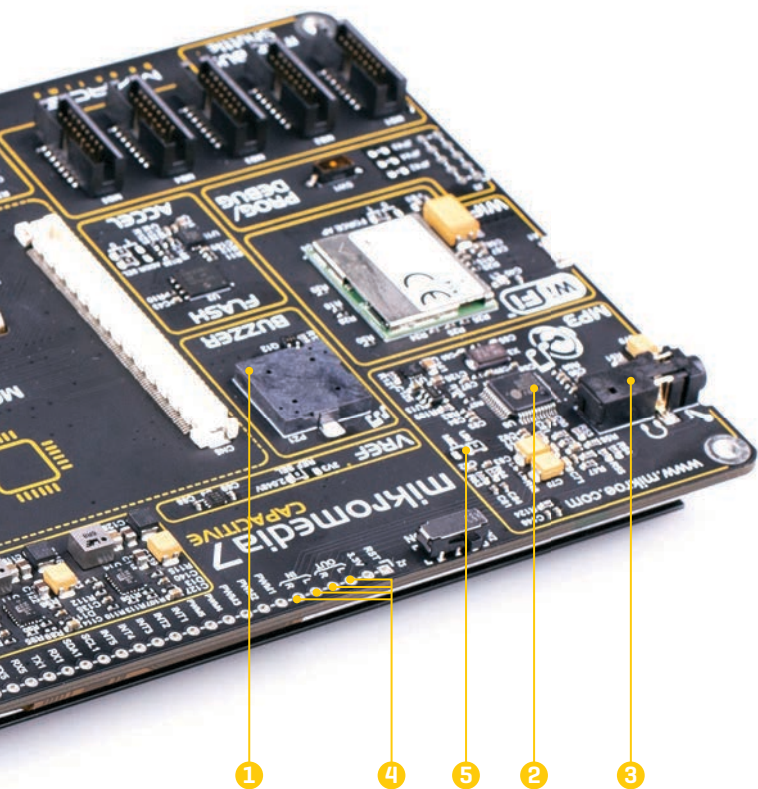

Figure 17: mikromedia 7 back view

6.1 Piezo buzzer

A piezo buzzer [1] is a simple device capable of reproducing sound. It is driven by a small pre-biased transistor. The buzzer can be driven by applying a PWM signal from the MCU at the base of the transistor: the pitch of the sound depends on the frequency of the PWM signal, while the volume can be controlled by changing its duty cycle. Since it is very easy to program, it can be very useful for simple alarms, notifications, and other types of simple sound signalization.



6.2 Audio CODEC

Resource-demanding and complex audio processing tasks can be offloaded from the host MCU by utilizing a dedicated audio CODEC IC, labeled as VS1053B [2]. This IC supports many different audio formats, commonly found on various digital audio devices. It can encode and

decode audio streams independently while performing DSP-related tasks in parallel. The VS1053B has several key features that make this IC very popular choice when it comes to audio processing.

By offering high-quality hardware compression (encoding), the VS1053B allows the audio to be recorded taking up much less space compared to the same audio information in its raw format. In combination with high quality ADCs and DACs, headphones driver, integrated audio equalizer, volume control, and more, it represents an all-around solution for any type of audio application. Along with the powerful graphics processor, the VS1053B audio processor completely rounds-up the multimedia aspects of the mikromedia 7 development board.

6.3 Audio connectors

The mikromedia 7 board is equipped with the 3.5mm four-pole headphones jack [3], allowing to connect a headset with a microphone. Two line-level audio outputs are also available over the 1x26 pin header [4].

The microphone input from the 3.5mm four-pole headset jack is multiplexed with two line-level audio inputs. By using an SMD jumper [5] located in the MP3 section, near the headphone jack, it is possible to select which audio input will be used by the VS1053B. The choices are:

LIN: two line-level inputs form the 1x26 pin header

MIC: electret microphone, connected over the 3.5mm headphone jack

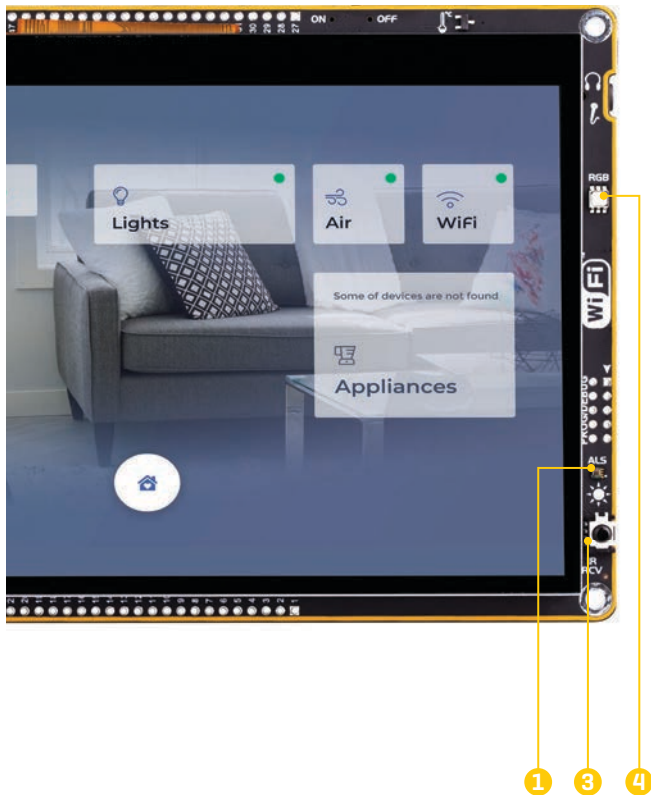

Figure 19: mikromedia 7 partial back view

7.3 IR receiver module

An infrared [IR] receiver [3] with the integrated PIN diode and a demodulation section allows simple control over an IR remote controller to be implemented. Thanks to the integrated demodulation section, the captured IR signal from the remote controller can be directly used by the host MCU. The TSOP6238 IR receiver module allows very simple implementation of the IR remote control option, for any application.

7.4 RGB LED

A high-brightness RGB LED [4] option can be used to provide visual feedback in a very simple way. There are three pre-biased bipolar transistors on each of the RGB LED segments (red, blue, and green), allowing them to be driven by the MCU. Three RGB LED segments are controlled by PWM pins of the host MCU, allowing them to be individually dimmed. Thanks to its reasonably low power consumption compared to a TFT display, RGB LED can be used in many situations when only simple visual feedback is required (e.g. signaling that the application is in the Stand-By mode).

7.5 Temperature sensor

The MCP9700A, an integrated low-power linear active thermistor allows measurement of the ambient temperature. This sensor provides an analog voltage which changes linearly with the applied temperature. This voltage can be sampled by the A/D converter on the host MCU, making it available for various user applications. The MCP9700A can measure the temperature within the range from -40°C to $+125^{\circ}\text{C}$, but the actual measurement range is limited by the thermal endurance of the mikromedia 7 board itself. Nevertheless, having a thermal sensor on board is very useful, allowing the development of thermal monitoring applications, weather stations, and similar.

7.6 Real-time clock [RTC]

The host MCU contains a real-time clock peripheral module [RTC]. The RTC peripheral uses a separate power supply source, typically a battery. To allow continuous tracking of time, mikromedia 7 is equipped with a button cell battery that maintains RTC functionality even if the main power supply is OFF. Extremely low power consumption of the RTC peripheral allows these batteries to last very long. The mikromedia 7 development board is equipped with the button cell battery holder, compatible with the CR1216, CR1220, and CR1225 button cell battery types, allowing it to include a real time clock within the applications.

RAPID
DEVELOPMENT
OF MULTIMEDIA
AND GUI-CENTRIC
APPLICATIONS

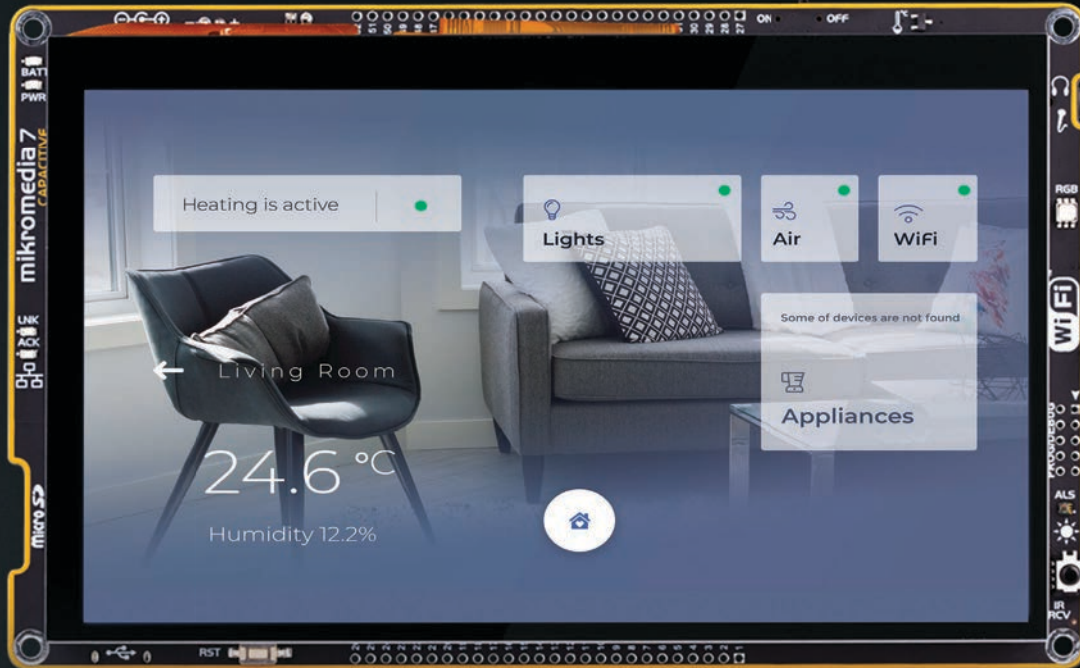

Heating is active

Lights

Air

WiFi

Some of devices are not found

Appliances



What makes you want to be an embedded developer? Is it the recognition of your skills, invention, or the development process? Whatever the reason is, we want to let you know that we are here for you every step of the way.

You can enjoy the process focused, yet relaxed – everything else is taken care of.

Enjoy premium.



What's next?

You have now completed the journey through each and every feature of mikromedia 7 CAPACITIVE development board. You got to know its modules and organization. Now you are ready to start using your new board. We are suggesting several steps which are probably the best way to begin.

1 COMPILERS

Easy programming, clean interface, powerful debugging, great support - our compilers come in three different flavors: mikroC PRO, mikroBASIC PRO and mikroPASCAL PRO for various architectures offering a complete rapid embedded development solution for these 3 major programming languages.

www.mikroe.com/compilers

2 PROJECTS

Once you have chosen your compiler, and since you already got the board, you are ready to start writing your first projects. We have equipped our compilers with dozens of examples that demonstrate the use of each and every feature of the mikromedia 7 CAPACITIVE development board. This makes an excellent starting point for future custom projects. Just load the example, read well commented code, and see how it works on hardware.

3 COMMUNITY

We invite you to join thousands of users of Mikroe development tools. You will find useful projects and tutorials and get help from a large user community. If you want to download free projects and libraries, or share your own code, please visit the Libstock website. With user profiles, you can get to know other programmers, and subscribe to receive notifications on their code.

www.libstock.mikroe.com

4 SUPPORT

Mikroe offers free Tech Support to the end of its life span, so if anything goes wrong, we are ready and willing to help. We know how important it is to be able to rely on someone in the moments when we are stuck with our projects for any reason, or facing a deadline. This is why our Support Department, as one of the pillars upon which our company is based, now also offers the Premium Technical Support to business users, ensuring even shorter time-frame for solutions. www.mikroe.com/support

DISCLAIMER

All the products owned by MikroElektronika are protected by copyright law and international copyright treaty. Therefore, this manual is to be treated as any other copyright material. No part of this manual, including product and software described herein, must be reproduced, stored in a retrieval system, translated or transmitted in any form or by any means, without the prior written permission of MikroElektronika. The manual PDF edition can be printed for private or local use, but not for distribution. Any modification of this manual is prohibited.

MikroElektronika provides this manual 'as is' without warranty of any kind, either expressed or implied, including, but not limited to, the implied warranties or conditions of merchantability or fitness for a particular purpose.

MikroElektronika shall assume no responsibility or liability for any errors, omissions and inaccuracies that may appear in this manual. In no event shall MikroElektronika, its directors, officers, employees or distributors be liable for any indirect, specific, incidental or consequential damages [including damages for loss of business profits and business information, business interruption or any other pecuniary loss] arising out of the use of this manual or product, even if MikroElektronika has been advised of the possibility of such damages. MikroElektronika reserves the right to change information contained in this manual at any time without prior notice, if necessary.

HIGH RISK ACTIVITIES

The products of MikroElektronika are not fault – tolerant nor designed, manufactured or intended for use or resale as on – line control equipment in hazardous environments requiring fail – safe performance, such as in the operation of nuclear facilities, aircraft navigation or communication systems, air traffic control, direct life support machines or weapons systems in which the failure of Software could lead directly to death, personal injury or severe physical or environmental damage ['High Risk Activities']. MikroElektronika and its suppliers specifically disclaim any expressed or implied warranty of fitness for High Risk Activities.

TRADEMARKS

The MikroElektronika name and logo, the MikroElektronika logo, mikroC, mikroBasic, mikroPascal, mikroProg, mikromedia, Fusion, Click boards™ and mikroBUS™ are trademarks of MikroElektronika. All other trademarks mentioned herein are property of their respective companies.

All other product and corporate names appearing in this manual may or may not be registered trademarks or copyrights of their respective companies, and are only used for identification or explanation and to the owners' benefit, with no intent to infringe.

Copyright © MikroElektronika, 2019, All Rights Reserved.

MIKROE
Time saving embedded tools

If you want to learn more about our products, please visit our website at www.mikroe.com

If you are experiencing some problems with any of our products or just need additional information, please place your ticket at www.mikroe.com/support

If you have any questions, comments or business proposals, do not hesitate to contact us at office@mikroe.com



Компания «Океан Электроники» предлагает заключение долгосрочных отношений при поставках импортных электронных компонентов на взаимовыгодных условиях!

Наши преимущества:

- Поставка оригинальных импортных электронных компонентов напрямую с производств Америки, Европы и Азии, а так же с крупнейших складов мира;
- Широкая линейка поставок активных и пассивных импортных электронных компонентов (более 30 млн. наименований);
- Поставка сложных, дефицитных, либо снятых с производства позиций;
- Оперативные сроки поставки под заказ (от 5 рабочих дней);
- Экспресс доставка в любую точку России;
- Помощь Конструкторского Отдела и консультации квалифицированных инженеров;
- Техническая поддержка проекта, помощь в подборе аналогов, поставка прототипов;
- Поставка электронных компонентов под контролем ВП;
- Система менеджмента качества сертифицирована по Международному стандарту ISO 9001;
- При необходимости вся продукция военного и аэрокосмического назначения проходит испытания и сертификацию в лаборатории (по согласованию с заказчиком);
- Поставка специализированных компонентов военного и аэрокосмического уровня качества (Xilinx, Altera, Analog Devices, Intersil, Interpoint, Microsemi, Actel, Aeroflex, Peregrine, VPT, Syfer, Eurofarad, Texas Instruments, MS Kennedy, Miteq, Cobham, E2V, MA-COM, Hittite, Mini-Circuits, General Dynamics и др.);

Компания «Океан Электроники» является официальным дистрибьютором и эксклюзивным представителем в России одного из крупнейших производителей разъемов военного и аэрокосмического назначения «JONHON», а так же официальным дистрибьютором и эксклюзивным представителем в России производителя высокотехнологичных и надежных решений для передачи СВЧ сигналов «FORSTAR».



JONHON

«JONHON» (основан в 1970 г.)

Разъемы специального, военного и аэрокосмического назначения:

(Применяются в военной, авиационной, аэрокосмической, морской, железнодорожной, горно- и нефтедобывающей отраслях промышленности)

«FORSTAR» (основан в 1998 г.)

ВЧ соединители, коаксиальные кабели,
кабельные сборки и микроволновые компоненты:

(Применяются в телекоммуникациях гражданского и специального назначения, в средствах связи, РЛС, а так же военной, авиационной и аэрокосмической отраслях промышленности).



Телефон: 8 (812) 309-75-97 (многоканальный)

Факс: 8 (812) 320-03-32

Электронная почта: ocean@oceanchips.ru

Web: <http://oceanchips.ru/>

Адрес: 198099, г. Санкт-Петербург, ул. Калинина, д. 2, корп. 4, лит. А