

Digital I/O Units

GT1-□D16(-1)/□D16MX(-1)/□D16ML(-1)/□D32ML(-1)/□D16DS(-1)

Digital I/O Units Compatible with MULTIPLE I/O TERMINAL

- Terminal block, connector, and high-density connector models are available.
- The circuit block of the terminal block model can be mounted or dismantled for ease of maintenance without disconnecting the wires.
- DIN track mounting.

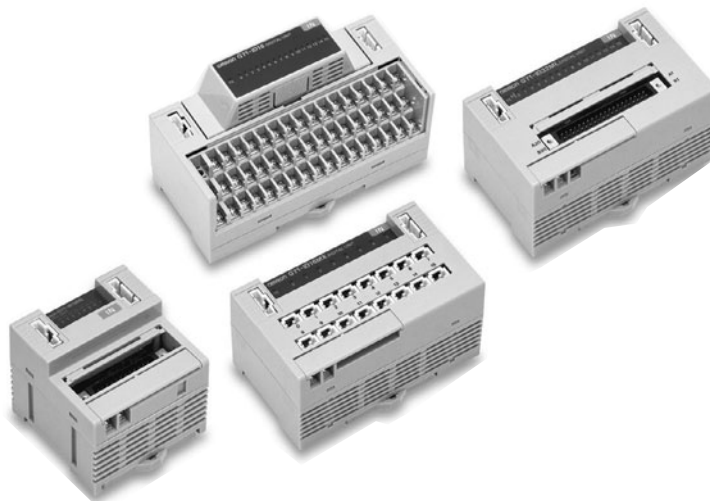

Ordering Information

Unit	I/O classification	Internal I/O common	I/O points	I/O connections	Power supply voltage	I/O specification	Model				
Terminal block model	Digital input	NPN (+ common)	16	M3 terminal board	24 VDC	DC/transistor	GT1-ID16				
		PNP (- common)					GT1-ID16-1				
	Digital output	NPN (- common)				0.5 A, DC/transistor	GT1-OD16				
		PNP (+ common)				GT1-OD16-1					
Connector model	Digital input	NPN (+ common)		Molex connector		Fujitsu connector	24 VDC	DC/transistor	GT1-ID16MX		
		PNP (- common)							GT1-ID16MX-1		
	Digital output	NPN (- common)						0.5 A, DC/transistor	GT1-OD16MX		
		PNP (+ common)						GT1-OD16MX-1			
	Digital input	NPN (+ common)	D-sub 25-pin connector		Fujitsu connector			DC/transistor	GT1-ID16ML		
		PNP (- common)							GT1-ID16ML-1		
	Digital output	NPN (- common)		0.5 A, DC/transistor		GT1-OD16ML					
		PNP (+ common)		GT1-OD16ML-1							
	High-density connector model	Digital input		NPN (+ common)		32		Fujitsu connector	24 VDC	DC/transistor	GT1-ID16DS
				PNP (- common)							GT1-ID16DS-1
		Digital output	NPN (- common)	0.5 A, DC/transistor	GT1-OD16DS						
			PNP (+ common)	GT1-OD16DS-1							
Digital input		NPN (+ common)	32	Fujitsu connector	24 VDC		DC/transistor			GT1-ID32ML	
		PNP (- common)								GT1-ID32ML-1	
Digital output	NPN (- common)	0.5 A, DC/transistor				GT1-OD32ML					
	PNP (+ common)	GT1-OD32ML-1									

General Specifications

I/O power supply voltage	20.4 to 26.4 VDC (24 VDC -15%/+10%)		
Current consumption *	Model	I/O Interface	Internal circuit
	GT1-ID16(-1)	35 mA max.	--
	GT1-OD16(-1)	35 mA max.	9 mA max.
	GT1-ID16MX(-1)	35 mA max.	--
	GT1-OD16MX(-1)	35 mA max.	9 mA max.
	GT1-ID16ML(-1)	35 mA max.	--
	GT1-OD16ML(-1)	35 mA max.	9 mA max.
	GT1-ID16DS(-1)	35 mA max.	--
	GT1-OD16DS(-1)	35 mA max.	9 mA max.
	GT1-ID32ML(-1)	55 mA max.	--
GT1-OD32ML(-1)	65 mA max.	11 mA max.	
Dielectric strength	500 VAC		
Noise immunity	Conforms to IEC61000-4-4 2 kV (power line)		
Vibration resistance	10 to 150 Hz, 1.0-mm double amplitude or 70 m/s ²		
Shock resistance	200 m/s ²		
Mounting method	DIN 35 mm-track mounting		
Mounting strength	No damage when 100 N pull load was applied in all directions (10 N min. in the DIN track direction)		
Terminal strength	No damage when 100 N pull load was applied		
Screw tightening torque	0.3 to 0.5 N·m		
Ambient operating temperature	-10°C to 55°C (with no icing or condensation)		
Ambient operating humidity	25% to 85% (with no icing or condensation)		
Ambient storage temperature	-25°C to 65°C		
Accessories	I/O Unit Connecting Cable (40 mm)		

* The above current consumption is a value with all 16 and 32 points turned ON excluding the current consumption of the external sensor connected to the Input Unit and the current consumption of the load connected to the Output Unit.

Applicable Connectors

Type		Model	Remarks	
Molex connector	Solderless terminal	Housing	51030-0330	
		Chain terminal	70058-0004	Corresponding to 24 to 30 AWG
			70058-0022	Corresponding to 22 to 24 AWG
		Loose terminal	70058-0204	Corresponding to 24 to 30 AWG
			70058-0272	Corresponding to 22 to 24 AWG
		Press-fit tool	57036-5000	Corresponding to 22 to 26 AWG
57037-5000	Corresponding to 24 to 30 AWG			
Fujitsu connector (16 points)	Solder terminal	FCN361J024-AU		
	Press-fit terminal	FCN367J024-AU/F		
	Solderless terminal	FCN363J024-AU		
Fujitsu connector (32 points)	Solder terminal	FCN361J040-AU		
	Press-fit terminal	FCN367J040-AU/F		
	Solderless terminal	FCN363J040-AU		
OMRON D-sub Connector	Plug	XM2A-2501		
	Hood	XM2S-2513	#4-40UNC inch screws	

Cables with High-density Connectors (Fujitsu-compatible Connectors)

I/O classification	Model
Digital input (16 points)	XW2Z-□□□A
	G79-□C
Digital output (16 points)	XW2Z-□□□A
	G79-□C
Digital input (32 points)	XW2Z-□□□B
	G79-□C□
Digital output (32 points)	XW2Z-□□□B
	G79-□C□

Note: Refer to page 162 for ordering information.

Input Specifications

Item	Model	GT1-ID□□
ON delay		1.5 ms max.
OFF delay		1.5 ms max.
ON voltage		15 V min. (between each input terminal and V or G)
OFF voltage		5 V max. (between each input terminal and V or G)
OFF current		1 mA max.
Insulation method		Photocoupler
Input indicators		LED (yellow)

Output Specifications

Item	Model	GT1-OD□□
Rated output current		0.5 A/point *
ON delay		0.5 ms max.
OFF delay		1.0 ms max.
Residual voltage		1.2 V max.
Leakage current		0.1 mA max.
Insulation method		Photocoupler
Output indicators		LED (yellow)

* Ensure that the total external load current does not exceed the values given in the following table.

Model	Total external load current
GT1-OD16/16MX/32ML(-1)	4 A
GT1-OD16ML/16DS(-1)	2.5 A

Cables for I/O Connector

Cables for Connector Terminal Conversion Units (16 Points)

I/O classification	Model	Applicable cable	Connectable model	Remarks
Digital input (16 points)	GT1-ID16ML(-1)	XW2Z-□□□A	XW2D-20G6	Slim-type Connector Terminal Conversion Unit
			XW2E-20G5-IN16	Common terminal (3-tier input type)
Digital output (16 points)	GT1-OD16ML(-1)		XW2D-20G6	Slim-type Connector Terminal Conversion Unit

Cables for Connector Terminal Conversion Units (32 Points)

I/O classification	Model	Applicable cable	Connectable model	Remarks
Digital input (32 points)	GT1-ID32ML(-1)	XW2Z-□□□B	XW2D-40G6	Slim-type Connector Terminal Conversion Unit
Digital output (32 points)	GT1-OD32ML(-1)			

Cables for I/O Blocks (16 Points)

I/O classification	Model	Applicable cable	Connectable model	Remarks
Digital input (16 points) NPN	GT1-ID16ML	G79-□C	G7TC-ID16 G7TC-IA16	For I/O Block input
Digital input (16 points) PNP	GT1-ID16ML-1		G7TC-ID16-1 G7TC-IA16-1	For I/O Block output
Digital output (16 points) NPN	GT1-OD16ML		G7TC-OC16 G7TC-OC08 G70D-SOC16 G70D-FOM16 G70D-VSOC16 G70D-VFOM16 G70A-ZOC16-3	For I/O Block output
			M7E Series M7F-□N□□□	Digital Display Unit
Digital output (16 points) PNP	GT1-OD16ML-1		G7TC-OC16-1 G70D-SOC16-1 G70A-ZOC16-4	For I/O Block output
		M7E-01MB□-□□ M7F-□P□□□	Digital Display Unit	

Cables for I/O Blocks (32 Points)

I/O classification	Model	Applicable cable	Connectable model	Remarks
Digital input (32 points) NPN	GT1-ID32ML	G79-I□C-□	G7TC-ID16 G7TC-IA16	For I/O Block input
Digital input (32 points) PNP	GT1-ID32ML-1		G7TC-ID16-1 G7TC-IA16-1	For I/O Block input
Digital output (32 points) NPN	GT1-OD32ML	G79-O□C-□	G7TC-OC16 G7TC-OC08 G70D-SOC16 G70D-FOM16 G70D-VSOC16 G70D-VFOM16 G70A-ZOC16-3	For I/O Block output
			G7TC-OC16-1 G70D-SOC16-1 G70D-FOM16-1 G70A-ZOC16-4	For I/O Block output

Note: For details of applicable cables and connectors, refer to pages 162 to 163.

Dimensions

● Terminal Block Model

- GT1-ID16
- GT1-ID16-1
- GT1-OD16
- GT1-OD16-1

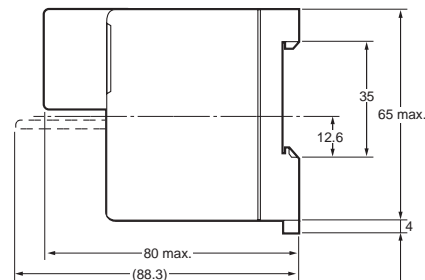

Note: Accessory cable included.

● Connector Model

- GT1-ID16MX
- GT1-ID16MX-1
- GT1-OD16MX
- GT1-OD16MX-1

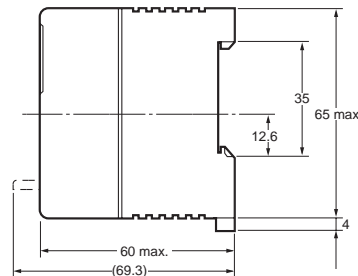

Note: Accessory cable included.

● Connector Model

- GT1-ID16ML
- GT1-ID16ML-1
- GT1-OD16ML
- GT1-OD16ML-1

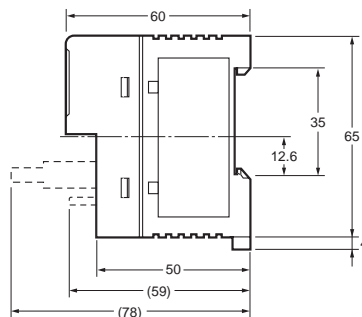

Note: Accessory cable included.

● Connector Model

- GT1-ID16DS
- GT1-ID16DS-1
- GT1-OD16DS
- GT1-OD16DS-1

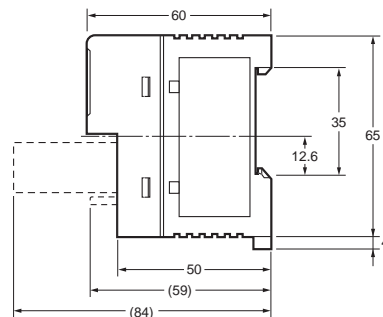

Note: Accessory cable included.

● High-density Connector Model

- GT1-ID32ML
- GT1-ID32ML-1
- GT1-OD32ML
- GT1-OD32ML-1

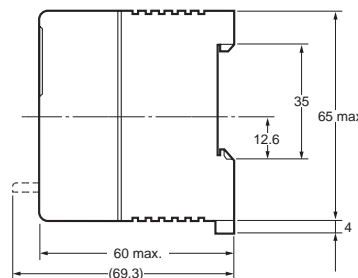

Note: Accessory cable included.

GT1-ID16ML



GT1-ID16ML-1

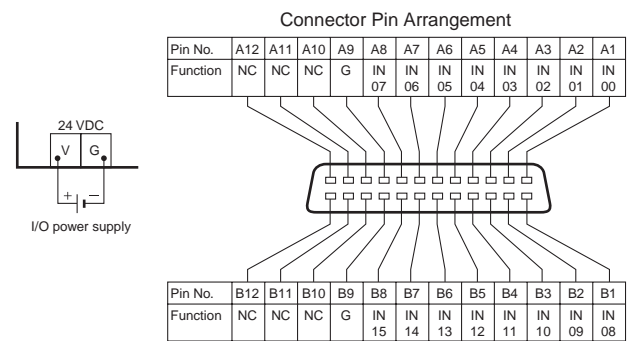

GT1-OD16ML



GT1-OD16ML-1



GT1-ID16DS



GT1-ID32ML



GT1-ID16DS-1



GT1-ID32ML-1



GT1-OD16DS



GT1-OD32ML



GT1-OD16DS-1



GT1-OD32ML-1



Компания «Океан Электроники» предлагает заключение долгосрочных отношений при поставках импортных электронных компонентов на взаимовыгодных условиях!

Наши преимущества:

- Поставка оригинальных импортных электронных компонентов напрямую с производств Америки, Европы и Азии, а так же с крупнейших складов мира;
- Широкая линейка поставок активных и пассивных импортных электронных компонентов (более 30 млн. наименований);
- Поставка сложных, дефицитных, либо снятых с производства позиций;
- Оперативные сроки поставки под заказ (от 5 рабочих дней);
- Экспресс доставка в любую точку России;
- Помощь Конструкторского Отдела и консультации квалифицированных инженеров;
- Техническая поддержка проекта, помощь в подборе аналогов, поставка прототипов;
- Поставка электронных компонентов под контролем ВП;
- Система менеджмента качества сертифицирована по Международному стандарту ISO 9001;
- При необходимости вся продукция военного и аэрокосмического назначения проходит испытания и сертификацию в лаборатории (по согласованию с заказчиком);
- Поставка специализированных компонентов военного и аэрокосмического уровня качества (Xilinx, Altera, Analog Devices, Intersil, Interpoint, Microsemi, Actel, Aeroflex, Peregrine, VPT, Syfer, Eurofarad, Texas Instruments, MS Kennedy, Miteq, Cobham, E2V, MA-COM, Hittite, Mini-Circuits, General Dynamics и др.);

Компания «Океан Электроники» является официальным дистрибьютором и эксклюзивным представителем в России одного из крупнейших производителей разъемов военного и аэрокосмического назначения «JONHON», а так же официальным дистрибьютором и эксклюзивным представителем в России производителя высокотехнологичных и надежных решений для передачи СВЧ сигналов «FORSTAR».



JONHON

«JONHON» (основан в 1970 г.)

Разъемы специального, военного и аэрокосмического назначения:

(Применяются в военной, авиационной, аэрокосмической, морской, железнодорожной, горно- и нефтедобывающей отраслях промышленности)

«FORSTAR» (основан в 1998 г.)

ВЧ соединители, коаксиальные кабели, кабельные сборки и микроволновые компоненты:

(Применяются в телекоммуникациях гражданского и специального назначения, в средствах связи, РЛС, а так же военной, авиационной и аэрокосмической отраслях промышленности).



Телефон: 8 (812) 309-75-97 (многоканальный)

Факс: 8 (812) 320-03-32

Электронная почта: ocean@oceanchips.ru

Web: <http://oceanchips.ru/>

Адрес: 198099, г. Санкт-Петербург, ул. Калинина, д. 2, корп. 4, лит. А