

10 MHz, 12V Op Amps

Features:

- Input Offset Voltage: ± 1 mV (typical)
- Quiescent Current: 2 mA (typical)
- Common Mode Rejection Ratio: 98 dB (typical)
- Power Supply Rejection Ratio: 94 dB (typical)
- Rail-to-Rail Output
- Supply Voltage Range:
 - Single-Supply Operation: 3.5V to 12V
 - Dual-Supply Operation: ± 1.75 V to ± 6 V
- Gain Bandwidth Product: 10 MHz (typical)
- Slew Rate: 10 V/ μ s (typical)
- Unity Gain Stable
- Extended Temperature Range: -40°C to $+125^{\circ}\text{C}$
- No Phase Reversal

Applications:

- Automotive Power Electronics
- Industrial Control Equipment
- Battery Powered Systems
- Medical Diagnostic Instruments

Design Aids:

- SPICE Macro Models
- FilterLab[®] Software
- MAPS (Microchip Advanced Part Selector)
- Analog Demonstration and Evaluation Boards
- Application Notes

Typical Application



Description:

Microchip's MCP6H91/2/4 family of operational amplifiers (op amps) has a wide supply voltage range of 3.5V to 12V and rail-to-rail output operation. This family is unity gain stable and has a gain bandwidth product of 10 MHz (typical). These devices operate with a single-supply voltage as high as 12V, while only drawing 2 mA/amplifier (typical) of quiescent current.

The MCP6H91/2/4 family is offered in single (MCP6H91), dual (MCP6H92) and quad (MCP6H94) configurations. All devices are fully specified in extended temperature range from -40°C to $+125^{\circ}\text{C}$.

Package Types



MCP6H91/2/4

NOTES:

1.0 ELECTRICAL CHARACTERISTICS

1.1 Absolute Maximum Ratings †

$V_{DD} - V_{SS}$	13.2V
Current at Input Pins.....	±2 mA
Analog Inputs (V_{IN+} , V_{IN-})††.....	$V_{SS} - 1.0V$ to $V_{DD} + 1.0V$
All Other Inputs and Outputs	$V_{SS} - 0.3V$ to $V_{DD} + 0.3V$
Difference Input Voltage.....	$V_{DD} - V_{SS}$
Output Short-Circuit Current.....	continuous
Current at Output and Supply Pins	±65 mA
Storage Temperature.....	-65°C to +150°C
Maximum Junction Temperature (T_J).....	+150°C
ESD protection on all pins (HBM; MM).....	≥ 2 kV; 200V

† **Notice:** Stresses above those listed under “Absolute Maximum Ratings” may cause permanent damage to the device. This is a stress rating only and functional operation of the device at those or any other conditions above those indicated in the operational listings of this specification is not implied. Exposure to maximum rating conditions for extended periods may affect device reliability.

†† See [Section 4.1.2, Input Voltage Limits](#).

DC ELECTRICAL SPECIFICATIONS

Electrical Characteristics: Unless otherwise indicated, $V_{DD} = +3.5V$ to $+12V$, $V_{SS} = GND$, $T_A = +25^\circ C$, $V_{CM} = V_{DD}/2 - 1.4V$, $V_{OUT} \approx V_{DD}/2$, $V_L = V_{DD}/2$ and $R_L = 10\text{ k}\Omega$ to V_L . (Refer to [Figure 1-1](#)).

Parameters	Sym.	Min.	Typ.	Max.	Units	Conditions
Input Offset						
Input Offset Voltage	V_{OS}	-4	±1	+4	mV	
Input Offset Drift with Temperature	$\Delta V_{OS}/\Delta T_A$	—	±2.5	—	$\mu V/^\circ C$	$T_A = -40^\circ C$ to $+125^\circ C$
Power Supply Rejection Ratio	PSRR	75	94	—	dB	
Input Bias Current and Impedance						
Input Bias Current	I_B	—	10	—	pA	
		—	400	—	pA	$T_A = +85^\circ C$
		—	9	25	nA	$T_A = +125^\circ C$
Input Offset Current	I_{OS}	—	±1	—	pA	
Common Mode Input Impedance	Z_{CM}	—	$10^{13} 6$	—	ΩpF	
Differential Input Impedance	Z_{DIFF}	—	$10^{13} 6$	—	ΩpF	
Common Mode						
Common Mode Input Voltage Range	V_{CMR}	$V_{SS} - 0.3$	—	$V_{DD} - 2.5$	V	
Common Mode Rejection Ratio	CMRR	75	91	—	dB	$V_{CM} = -0.3V$ to $1.0V$, $V_{DD} = 3.5V$
		80	97	—	dB	$V_{CM} = -0.3V$ to $2.5V$, $V_{DD} = 5V$
		80	98	—	dB	$V_{CM} = -0.3V$ to $9.5V$, $V_{DD} = 12V$
Open-Loop Gain						
DC Open-Loop Gain (Large Signal)	A_{OL}	95	115	—	dB	$0.2V < V_{OUT} < (V_{DD} - 0.2V)$

MCP6H91/2/4

DC ELECTRICAL SPECIFICATIONS (CONTINUED)

Electrical Characteristics: Unless otherwise indicated, $V_{DD} = +3.5V$ to $+12V$, $V_{SS} = GND$, $T_A = +25^\circ C$, $V_{CM} = V_{DD}/2 - 1.4V$, $V_{OUT} \approx V_{DD}/2$, $V_L = V_{DD}/2$ and $R_L = 10\text{ k}\Omega$ to V_L . (Refer to [Figure 1-1](#)).

Parameters	Sym.	Min.	Typ.	Max.	Units	Conditions
Output						
High-Level Output Voltage	V_{OH}	3.490	3.495	—	V	$V_{DD} = 3.5V$ 0.5V input overdrive
		4.985	4.993	—	V	$V_{DD} = 5V$ 0.5V input overdrive
		11.970	11.980	—	V	$V_{DD} = 12V$ 0.5V input overdrive
Low-Level Output Voltage	V_{OL}	—	0.005	0.010	V	$V_{DD} = 3.5V$ 0.5 V input overdrive
		—	0.007	0.015	V	$V_{DD} = 5V$ 0.5 V input overdrive
		—	0.020	0.030	V	$V_{DD} = 12V$ 0.5 V input overdrive
Output Short-Circuit Current	I_{SC}	—	± 35	—	mA	$V_{DD} = 3.5V$
		—	± 41	—	mA	$V_{DD} = 5V$
		—	± 41	—	mA	$V_{DD} = 12V$
Power Supply						
Supply Voltage	V_{DD}	3.5	—	12	V	Single-Supply operation
		± 1.75	—	± 6	V	Dual-Supply operation
Quiescent Current per Amplifier	I_Q	—	2	2.8	mA	$I_O = 0$, $V_{CM} = V_{DD}/4$

AC ELECTRICAL SPECIFICATIONS

Electrical Characteristics: Unless otherwise indicated, $T_A = +25^\circ C$, $V_{DD} = +3.5V$ to $+12V$, $V_{SS} = GND$, $V_{CM} = V_{DD}/2 - 1.4V$, $V_{OUT} \approx V_{DD}/2$, $V_L = V_{DD}/2$, $R_L = 10\text{ k}\Omega$ to V_L and $C_L = 60\text{ pF}$. (Refer to [Figure 1-1](#)).

Parameters	Sym.	Min.	Typ.	Max.	Units	Conditions
AC Response						
Gain Bandwidth Product	GBWP	—	10	—	MHz	
Phase Margin	PM	—	60	—	$^\circ C$	$G = +1V/V$
Slew Rate	SR	—	10	—	V/ μs	
Noise						
Input Noise Voltage	E_{ni}	—	10	—	μV_{p-p}	$f = 0.1\text{ Hz to }10\text{ Hz}$
Input Noise Voltage Density	E_{ni}	—	23	—	nV/ \sqrt{Hz}	$f = 1\text{ kHz}$
		—	12	—	nV/ \sqrt{Hz}	$f = 10\text{ kHz}$
Input Noise Current Density	i_{ni}	—	1.9	—	fA/ \sqrt{Hz}	$f = 1\text{ kHz}$

TEMPERATURE SPECIFICATIONS

Electrical Characteristics: Unless otherwise indicated, $V_{DD} = +3.5V$ to $+12V$ and $V_{SS} = GND$.						
Parameters	Sym.	Min.	Typ.	Max.	Units	Conditions
Temperature Ranges						
Operating Temperature Range	T_A	-40	—	+125	°C	Note 1
Storage Temperature Range	T_A	-65	—	+150	°C	
Thermal Package Resistances						
Thermal Resistance, 8L-2x3 TDFN	θ_{JA}	—	52.5	—	°C/W	
Thermal Resistance, 8L-SOIC	θ_{JA}	—	149.5	—	°C/W	
Thermal Resistance, 14L-SOIC	θ_{JA}	—	95.3	—	°C/W	
Thermal Resistance, 14L-TSSOP	θ_{JA}	—	100	—	°C/W	

Note 1: The internal junction temperature (T_J) must not exceed the absolute maximum specification of $+150^\circ\text{C}$.

1.2 Test Circuits

The circuit used for most DC and AC tests is shown in [Figure 1-1](#). This circuit can independently set V_{CM} and V_{OUT} (refer to [Equation 1-1](#)). Note that V_{CM} is not the circuit's Common mode voltage ($(V_P + V_M)/2$), and that V_{OST} includes V_{OS} plus the effects (on the input offset error, V_{OST}) of temperature, CMRR, PSRR and A_{OL} .

EQUATION 1-1:

$$G_{DM} = R_F/R_G$$

$$V_{CM} = (V_P + V_{DD}/2)/2$$

$$V_{OST} = V_{IN-} - V_{IN+}$$

$$V_{OUT} = (V_{DD}/2) + (V_P - V_M) + V_{OST} \cdot (1 + G_{DM})$$

Where:

$$G_{DM} = \text{Differential Mode Gain} \quad (\text{V/V})$$

$$V_{CM} = \text{Op Amp's Common Mode Input Voltage} \quad (\text{V})$$

$$V_{OST} = \text{Op Amp's Total Input Offset Voltage} \quad (\text{mV})$$



FIGURE 1-1: AC and DC Test Circuit for Most Specifications.

MCP6H91/2/4

NOTES:

2.0 TYPICAL PERFORMANCE CURVES

Note: The graphs and tables provided following this note are a statistical summary based on a limited number of samples and are provided for informational purposes only. The performance characteristics listed herein are not tested or guaranteed. In some graphs or tables, the data presented may be outside the specified operating range (e.g., outside specified power supply range) and therefore outside the warranted range.

Note: Unless otherwise indicated, $T_A = +25^\circ\text{C}$, $V_{DD} = +3.5\text{V}$ to $+12\text{V}$, $V_{SS} = \text{GND}$, $V_{CM} = V_{DD}/2 - 1.4\text{V}$, $V_{OUT} \approx V_{DD}/2$, $V_L = V_{DD}/2$, $R_L = 10\text{ k}\Omega$ to V_L and $C_L = 60\text{ pF}$.

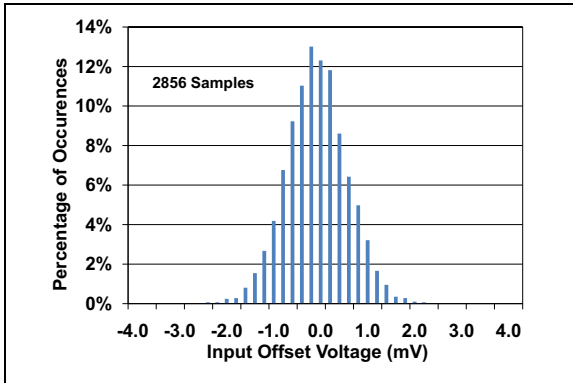

FIGURE 2-1: Input Offset Voltage.

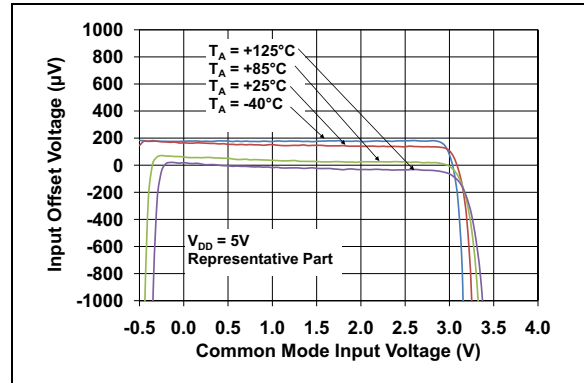

FIGURE 2-4: Input Offset Voltage vs. Common Mode Input Voltage.

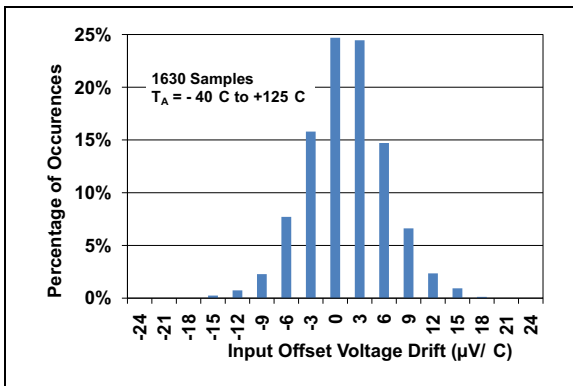

FIGURE 2-2: Input Offset Voltage Drift.

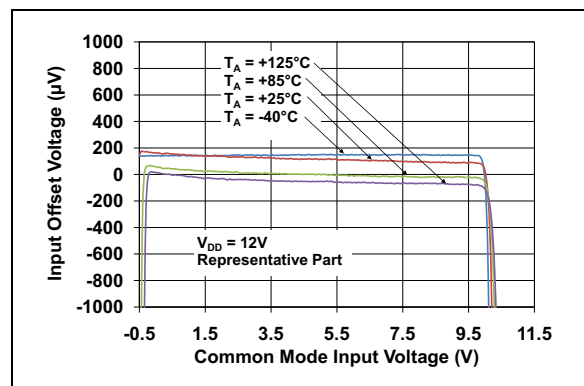

FIGURE 2-5: Input Offset Voltage vs. Common Mode Input Voltage.

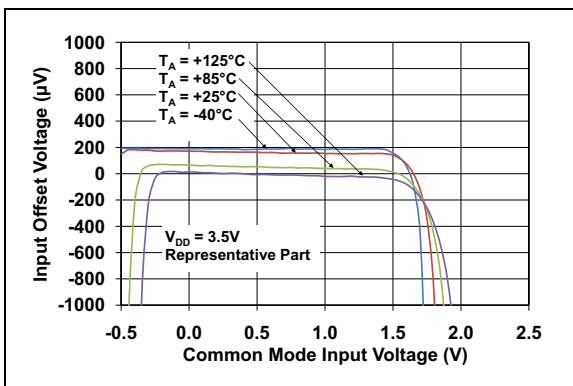

FIGURE 2-3: Input Offset Voltage vs. Common Mode Input Voltage.

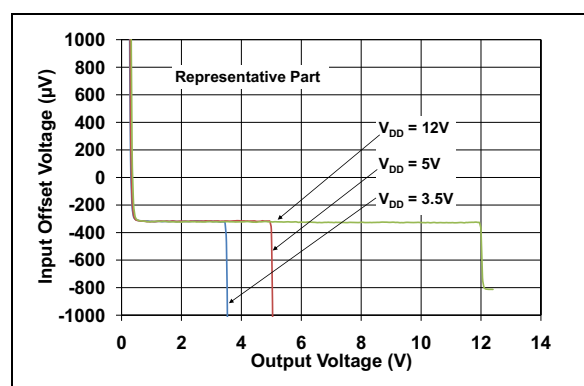

FIGURE 2-6: Input Offset Voltage vs. Output Voltage.

MCP6H91/2/4

Note: Unless otherwise indicated, $T_A = +25^\circ\text{C}$, $V_{DD} = +3.5\text{V}$ to $+12\text{V}$, $V_{SS} = \text{GND}$, $V_{CM} = V_{DD}/2 - 1.4\text{V}$, $V_{OUT} \approx V_{DD}/2$, $V_L = V_{DD}/2$, $R_L = 10\text{ k}\Omega$ to V_L and $C_L = 60\text{ pF}$.



FIGURE 2-7: Input Offset Voltage vs. Power Supply Voltage.



FIGURE 2-10: CMRR, PSRR vs. Frequency.



FIGURE 2-8: Input Noise Voltage Density vs. Frequency.



FIGURE 2-11: CMRR, PSRR vs. Ambient Temperature.



FIGURE 2-9: Input Noise Voltage Density vs. Common Mode Input Voltage.



FIGURE 2-12: Input Bias, Offset Currents vs. Ambient Temperature.

Note: Unless otherwise indicated, $T_A = +25^\circ\text{C}$, $V_{DD} = +3.5\text{V}$ to $+12\text{V}$, $V_{SS} = \text{GND}$, $V_{CM} = V_{DD}/2 - 1.4\text{V}$, $V_{OUT} \approx V_{DD}/2$, $V_L = V_{DD}/2$, $R_L = 10\text{ k}\Omega$ to V_L and $C_L = 60\text{ pF}$.

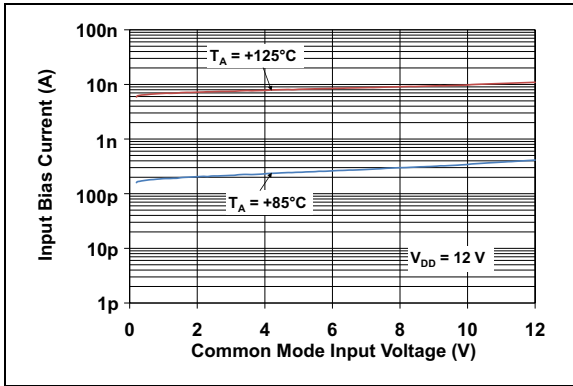

FIGURE 2-13: Input Bias Current vs. Common Mode Input Voltage.

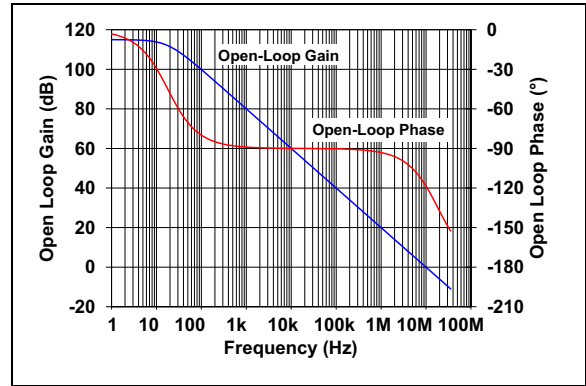

FIGURE 2-16: Open-Loop Gain, Phase vs. Frequency.

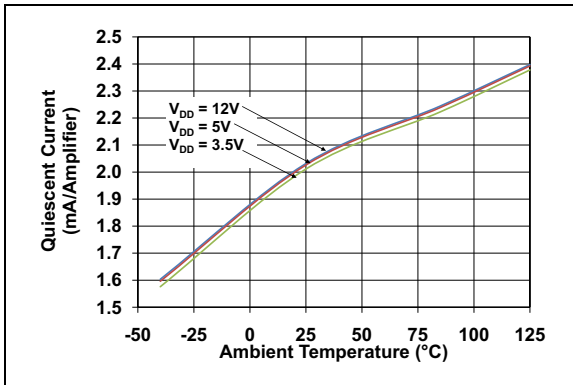

FIGURE 2-14: Quiescent Current vs. Ambient Temperature.

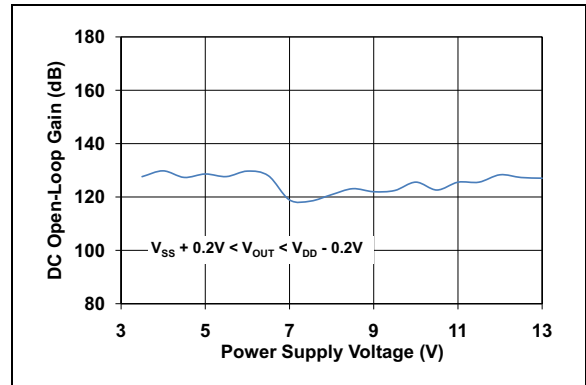

FIGURE 2-17: DC Open-Loop Gain vs. Power Supply Voltage.

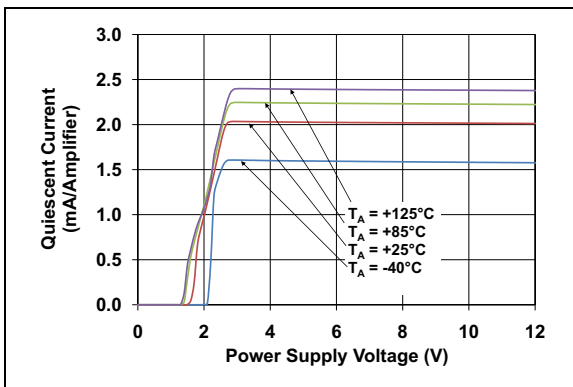

FIGURE 2-15: Quiescent Current vs. Power Supply Voltage.

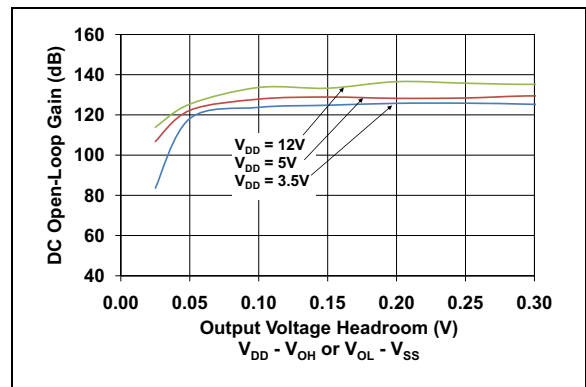

FIGURE 2-18: DC Open-Loop Gain vs. Output Voltage Headroom.

MCP6H91/2/4

Note: Unless otherwise indicated, $T_A = +25^\circ\text{C}$, $V_{DD} = +3.5\text{V}$ to $+12\text{V}$, $V_{SS} = \text{GND}$, $V_{CM} = V_{DD}/2 - 1.4\text{V}$, $V_{OUT} \approx V_{DD}/2$, $V_L = V_{DD}/2$, $R_L = 10\text{ k}\Omega$ to V_L and $C_L = 60\text{ pF}$.

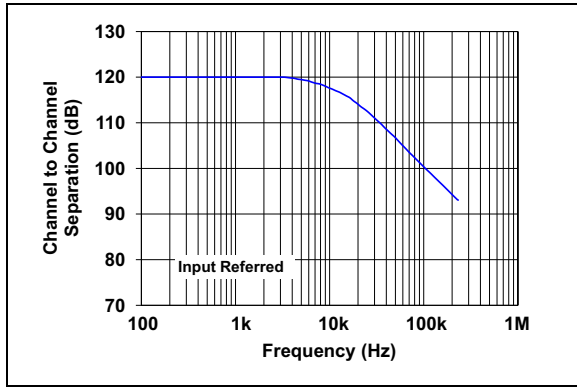

FIGURE 2-19: Channel-to-Channel Separation vs. Frequency (MCP6H92 only).

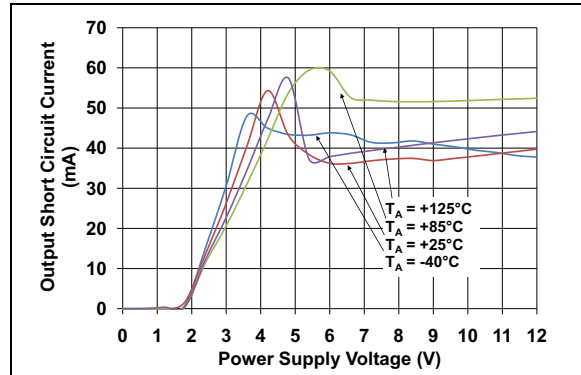

FIGURE 2-22: Output Short Circuit Current vs. Power Supply Voltage.

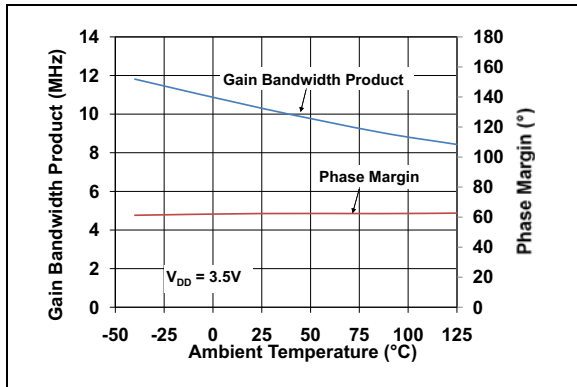

FIGURE 2-20: Gain Bandwidth Product, Phase Margin vs. Ambient Temperature.

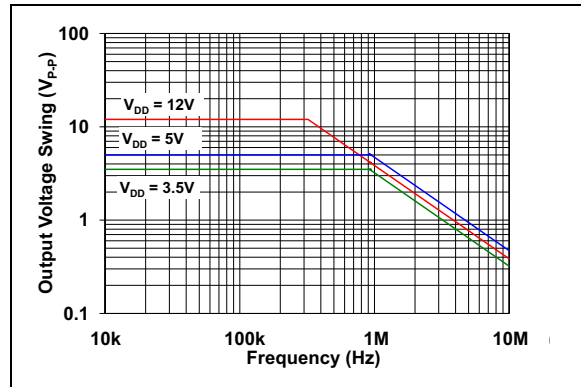

FIGURE 2-23: Output Voltage Swing vs. Frequency.

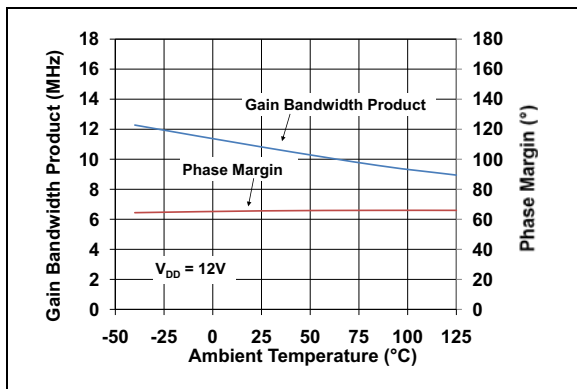

FIGURE 2-21: Gain Bandwidth Product, Phase Margin vs. Ambient Temperature.

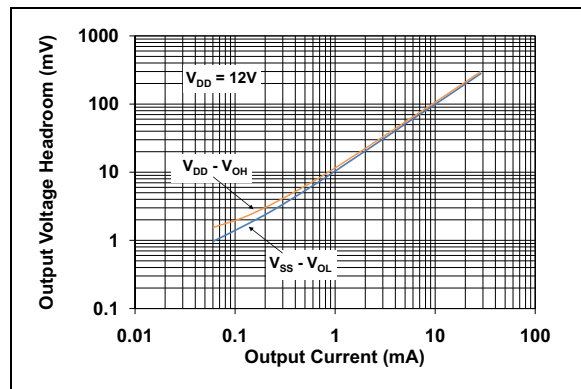

FIGURE 2-24: Output Voltage Headroom vs. Output Current.

Note: Unless otherwise indicated, $T_A = +25^\circ\text{C}$, $V_{DD} = +3.5\text{V to } +12\text{V}$, $V_{SS} = \text{GND}$, $V_{CM} = V_{DD}/2 - 1.4\text{V}$, $V_{OUT} \approx V_{DD}/2$, $V_L = V_{DD}/2$, $R_L = 10\text{ k}\Omega$ to V_L and $C_L = 60\text{ pF}$.

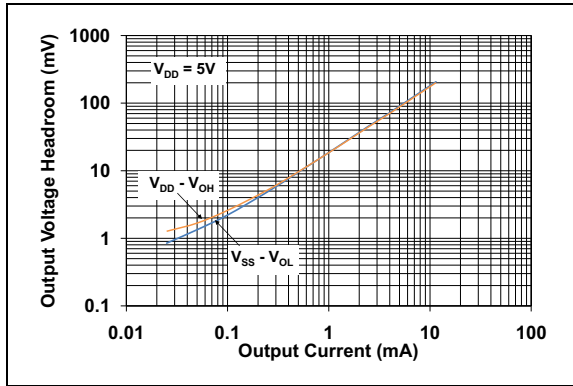

FIGURE 2-25: Output Voltage Headroom vs. Output Current.

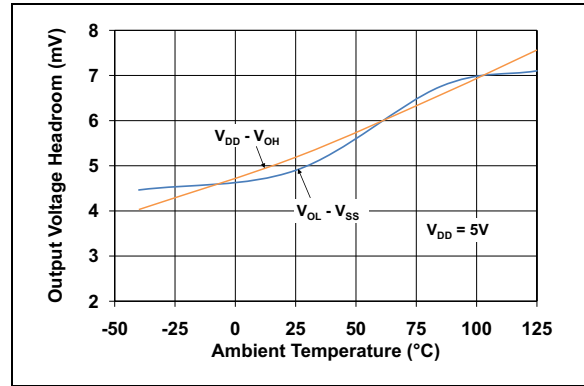

FIGURE 2-28: Output Voltage Headroom vs. Ambient Temperature.

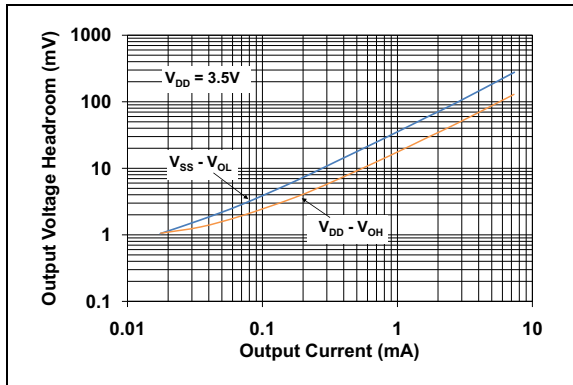

FIGURE 2-26: Output Voltage Headroom vs. Output Current.

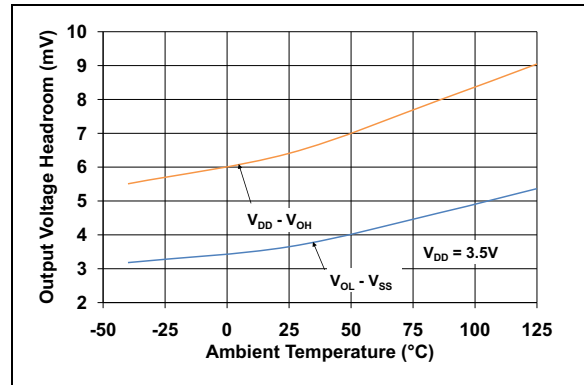

FIGURE 2-29: Output Voltage Headroom vs. Ambient Temperature.

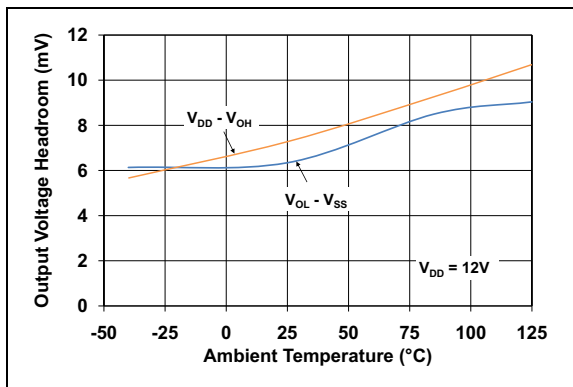

FIGURE 2-27: Output Voltage Headroom vs. Ambient Temperature.

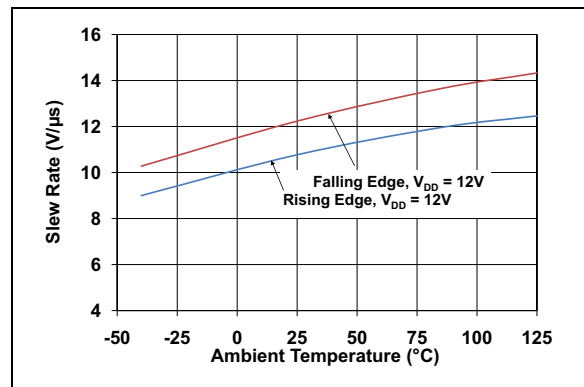

FIGURE 2-30: Slew Rate vs. Ambient Temperature.

MCP6H91/2/4

Note: Unless otherwise indicated, $T_A = +25^\circ\text{C}$, $V_{DD} = +3.5\text{ V to }+12\text{ V}$, $V_{SS} = \text{GND}$, $V_{CM} = V_{DD}/2 - 1.4\text{V}$, $V_{OUT} \approx V_{DD}/2$, $V_L = V_{DD}/2$, $R_L = 10\text{ k}\Omega$ to V_L and $C_L = 60\text{ pF}$.

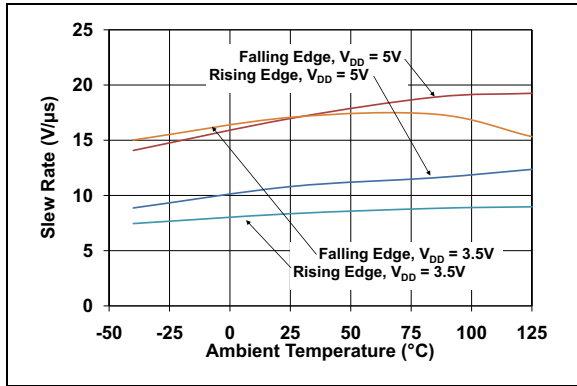

FIGURE 2-31: Slew Rate vs. Ambient Temperature.



FIGURE 2-34: Large Signal Non-Inverting Pulse Response.

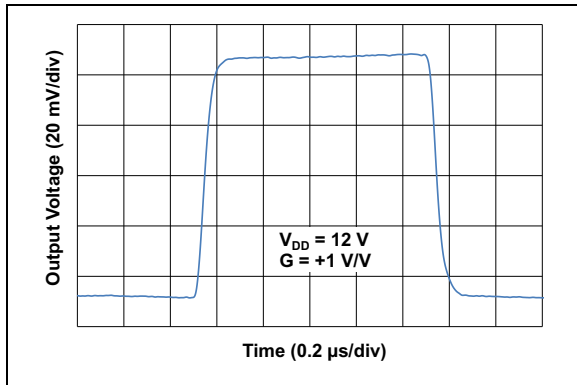

FIGURE 2-32: Small Signal Non-Inverting Pulse Response.



FIGURE 2-35: Large Signal Inverting Pulse Response.

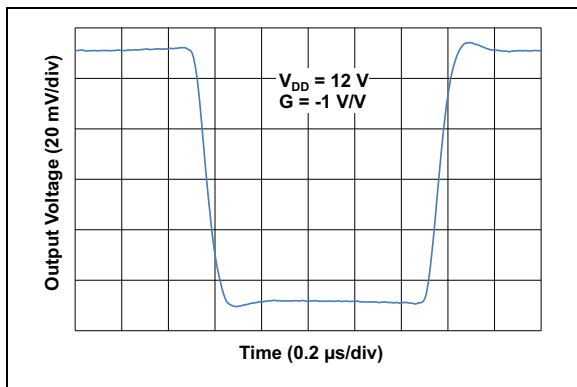

FIGURE 2-33: Small Signal Inverting Pulse Response.



FIGURE 2-36: The MCP6H91/2/4 Shows No Phase Reversal.

Note: Unless otherwise indicated, $T_A = +25^\circ\text{C}$, $V_{DD} = +3.5\text{ V to }+12\text{ V}$, $V_{SS} = \text{GND}$, $V_{CM} = V_{DD}/2 - 1.4\text{V}$, $V_{OUT} \approx V_{DD}/2$, $V_L = V_{DD}/2$, $R_L = 10\text{ k}\Omega$ to V_L and $C_L = 60\text{ pF}$.



FIGURE 2-37: Closed Loop Output Impedance vs. Frequency.



FIGURE 2-38: Measured Input Current vs. Input Voltage (below V_{SS}).

MCP6H91/2/4

NOTES:

3.0 PIN DESCRIPTIONS

Descriptions of the pins are listed in [Table 3-1](#).

TABLE 3-1: PIN FUNCTION TABLE

MCP6H91		MCP6H92		MCP6H94	Symbol	Description
SOIC	2x3 TDFN	SOIC	2x3 TDFN	SOIC, TSSOP		
6	6	1	1	1	V_{OUT}, V_{OUTA}	Analog Output (op amp A)
2	2	2	2	2	V_{IN-}, V_{INA-}	Inverting Input (op amp A)
3	3	3	3	3	V_{IN+}, V_{INA+}	Non-inverting Input (op amp A)
7	7	8	8	4	V_{DD}	Positive Power Supply
—	—	5	5	5	V_{INB+}	Non-inverting Input (op amp B)
—	—	6	6	6	V_{INB-}	Inverting Input (op amp B)
—	—	7	7	7	V_{OUTB}	Analog Output (op amp B)
—	—	—	—	8	V_{OUTC}	Analog Output (op amp C)
—	—	—	—	9	V_{INC-}	Inverting Input (op amp C)
—	—	—	—	10	V_{INC+}	Non-inverting Input (op amp C)
4	4	4	4	11	V_{SS}	Negative Power Supply
—	—	—	—	12	V_{IND+}	Non-inverting Input (op amp D)
—	—	—	—	13	V_{IND-}	Inverting Input (op amp D)
—	—	—	—	14	V_{OUTD}	Analog Output (op amp D)
1, 5, 8	1, 5, 8	—	—	—	NC	No Internal Connection
—	9	—	9	—	EP	Exposed Thermal Pad (EP); must be connected to V_{SS} .

3.1 Analog Outputs

The output pins are low-impedance voltage sources.

3.2 Analog Inputs

The non-inverting and inverting inputs are high-impedance CMOS inputs with low bias currents.

3.3 Power Supply Pins

The positive power supply (V_{DD}) is 3.5V to 12V higher than the negative power supply (V_{SS}). For normal operation, the other pins are at voltages between V_{SS} and V_{DD} .

Typically, these parts can be used in single-supply operation or dual-supply operation. Also, V_{DD} will need bypass capacitors.

3.4 Exposed Thermal Pad (EP)

There is an internal electrical connection between the Exposed Thermal Pad (EP) and the V_{SS} pin; they must be connected to the same potential on the Printed Circuit Board (PCB).

This pad can be connected to a PCB ground plane to provide a larger heat sink. This improves the package thermal resistance (θ_{JA}).

MCP6H91/2/4

NOTES:

4.0 APPLICATION INFORMATION

The MCP6H91/2/4 family of op amps is manufactured using Microchip's state-of-the-art CMOS process and is specifically designed for low-power, high-precision applications.

4.1 Inputs

4.1.1 PHASE REVERSAL

The MCP6H91/2/4 op amps are designed to prevent phase reversal when the input pins exceed the supply voltages. Figure 2-36 shows the input voltage exceeding the supply voltage without any phase reversal.

4.1.2 INPUT VOLTAGE LIMITS

In order to prevent damage and/or improper operation of these amplifiers, the circuit must limit the voltages at the input pins (see Section 1.1 "Absolute Maximum Ratings †").

The ESD protection on the inputs can be depicted as shown in Figure 4-1. This structure was chosen to protect the input transistors against many (but not all) overvoltage conditions, and to minimize the input bias current (I_B).



FIGURE 4-1: Simplified Analog Input ESD Structures.

The input ESD diodes clamp the inputs when they try to go more than one diode drop below V_{SS} . They also clamp any voltages that go well above V_{DD} . Their breakdown voltage is high enough to allow normal operation, but not low enough to protect against slow overvoltage (beyond V_{DD}) events. Very fast ESD events (that meet the specification) are limited so that damage does not occur.

In some applications, it may be necessary to prevent excessive voltages from reaching the op amp inputs; Figure 4-2 shows one approach to protecting these inputs.

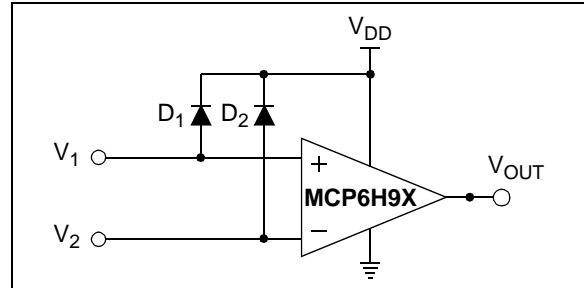

FIGURE 4-2: Protecting the Analog Inputs.

A significant amount of current can flow out of the inputs when the Common mode voltage (V_{CM}) is below ground (V_{SS}), as shown in Figure 2-38.

4.1.3 INPUT CURRENT LIMITS

In order to prevent damage and/or improper operation of these amplifiers, the circuit must limit the currents into the input pins (see Section 1.1 "Absolute Maximum Ratings †").

Figure 4-3 shows one approach to protecting these inputs. The resistors R_1 and R_2 limit the possible currents in or out of the input pins (and the ESD diodes, D_1 and D_2). The diode currents will go through either V_{DD} or V_{SS} .

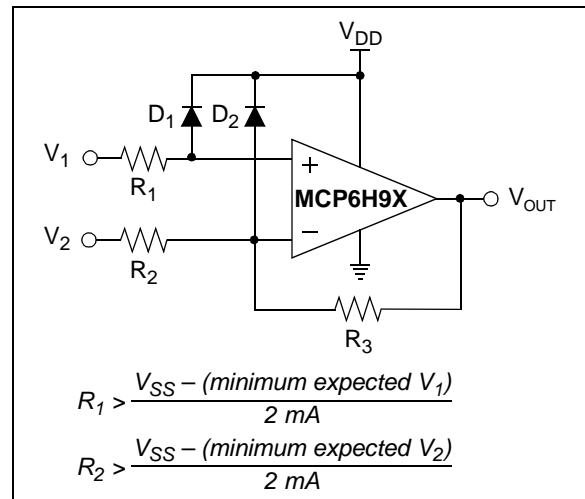

FIGURE 4-3: Protecting the Analog Inputs.

4.1.4 NORMAL OPERATION

The inputs of the MCP6H91/2/4 op amps connect to a differential PMOS input stage. It operates at a low Common mode input voltage (V_{CM}), including ground. With this topology, the device operates with a V_{CM} up to $V_{DD} - 2.5V$ and $0.3V$ below V_{SS} (refer to Figures 2-3 through 2-5). The input offset voltage is measured at $V_{CM} = V_{SS} - 0.3V$ and $V_{DD} - 2.5V$ to ensure proper operation.

For a unity gain buffer, V_{IN} must be maintained below $V_{DD} - 2.5V$ for correct operation.

MCP6H91/2/4

4.2 Rail-to-Rail Output

The output voltage range of the MCP6H91/2/4 op amps is 0.020V (typical) and 11.980V (typical) when $R_L = 10\text{ k}\Omega$ is connected to $V_{DD}/2$ and $V_{DD} = 12\text{V}$. Refer to Figures 2-24 through 2-29 for more information.

4.3 Capacitive Loads

Driving large capacitive loads can cause stability problems for voltage feedback op amps. As the load capacitance increases, the feedback loop's phase margin decreases and the closed-loop bandwidth is reduced. This produces gain peaking in the frequency response, with overshoot and ringing in the step response. While a unity-gain buffer ($G = +1\text{V/V}$) is the most sensitive to capacitive loads, all gains show the same general behavior.

When driving large capacitive loads with these op amps (e.g., $> 100\text{ pF}$ when $G = +1\text{V/V}$), a small series resistor at the output (R_{ISO} in Figure 4-4) improves the feedback loop's phase margin (stability) by making the output load resistive at higher frequencies. The bandwidth will generally be lower than the bandwidth with no capacitance load.

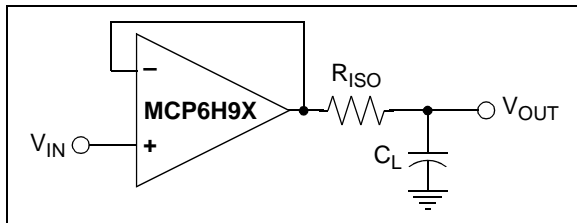

FIGURE 4-4: Output Resistor, R_{ISO} Stabilizes Large Capacitive Loads.

Figure 4-5 gives the recommended R_{ISO} values for different capacitive loads and gains. The x-axis is the normalized load capacitance (C_L/G_N), where G_N is the circuit's noise gain. For non-inverting gains, G_N and the Signal Gain are equal. For inverting gains, G_N is $1 + |\text{Signal Gain}|$ (e.g., -1V/V gives $G_N = +2\text{V/V}$).

After selecting R_{ISO} for your circuit, double check the resulting frequency response peaking and step response overshoot. Modify R_{ISO} 's value until the response is reasonable. Bench evaluation and simulations with the MCP6H91/2/4 SPICE macro model are helpful.

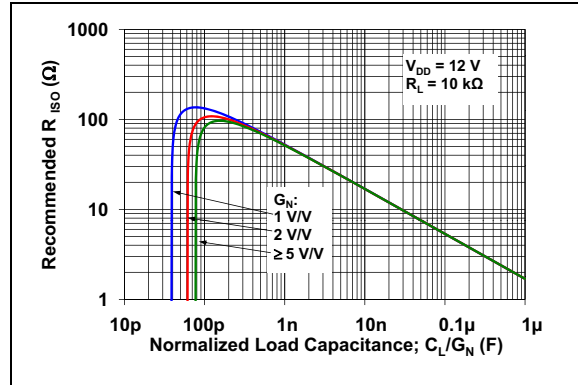

FIGURE 4-5: Recommended R_{ISO} Values for Capacitive Loads.

4.4 Supply Bypass

With this family of operational amplifiers, the power supply pin (V_{DD} for single supply) should have a local bypass capacitor (i.e., $0.01\text{ }\mu\text{F}$ to $0.1\text{ }\mu\text{F}$) within 2 mm for good high-frequency performance. It can use a bulk capacitor (i.e., $1\text{ }\mu\text{F}$ or larger) within 100 mm to provide large, slow currents. This bulk capacitor can be shared with other analog parts.

4.5 Unused Op Amps

An unused op amp in a quad package (MCP6H94) should be configured as shown in Figure 4-6. These circuits prevent the output from toggling and causing crosstalk. Circuit A sets the op amp at its minimum noise gain. The resistor divider produces any desired reference voltage within the output voltage range of the op amp, and the op amp buffers that reference voltage. Circuit B uses the minimum number of components and operates as a comparator, but it may draw more current.

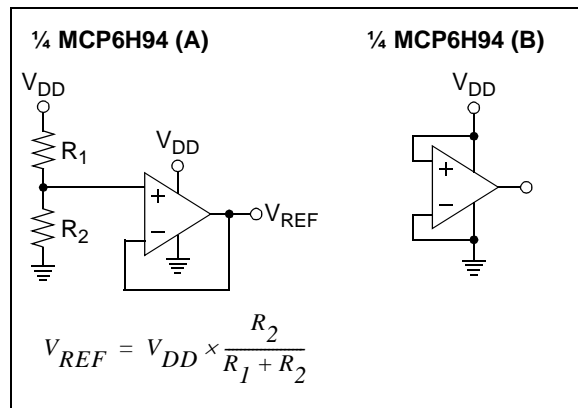

FIGURE 4-6: Unused Op Amps.

4.6 PCB Surface Leakage

In applications where low input bias current is critical, PCB surface leakage effects need to be considered. Surface leakage is caused by humidity, dust or other contamination on the board. Under low-humidity conditions, a typical resistance between nearby traces is $10^{12}\Omega$. A 15V difference would cause 15 pA of current to flow; which is greater than the MCP6H91/2/4 family's bias current at +25°C (10 pA, typical).

The easiest way to reduce surface leakage is to use a guard ring around sensitive pins (or traces). The guard ring is biased at the same voltage as the sensitive pin. An example of this type of layout is shown in Figure 4-7.



FIGURE 4-7: Example Guard Ring Layout for Inverting Gain.

1. Non-inverting Gain and Unity-Gain Buffer:
 - a. Connect the non-inverting pin (V_{IN+}) to the input with a wire that does not touch the PCB surface.
 - b. Connect the guard ring to the inverting input pin (V_{IN-}). This biases the guard ring to the Common mode input voltage.
2. Inverting Gain and Trans-impedance Gain Amplifiers (convert current to voltage, such as photo detectors):
 - a. Connect the guard ring to the non-inverting input pin (V_{IN+}). This biases the guard ring to the same reference voltage as the op amp (e.g., $V_{DD}/2$ or ground).
 - b. Connect the inverting input pin (V_{IN-}) to the input with a wire that does not touch the PCB surface.

4.7 Application Circuits

4.7.1 DIFFERENCE AMPLIFIER

The MCP6H91/2/4 op amps can be used in current sensing applications. Figure 4-8 shows a resistor (R_{SEN}) that converts the sensor current (I_{SEN}) to voltage, as well as a difference amplifier that amplifies the voltage across the resistor while rejecting Common mode noise. R_1 and R_2 must be well matched to obtain an acceptable Common Mode Rejection Ratio (CMRR). Moreover, R_{SEN} should be much smaller than R_1 and R_2 in order to minimize the resistive loading of the source.

To ensure proper operation, the op amp Common mode input voltage must be kept within the allowed range. The reference voltage (V_{REF}) is supplied by a low-impedance source. In single-supply applications, V_{REF} is typically $V_{DD}/2$.

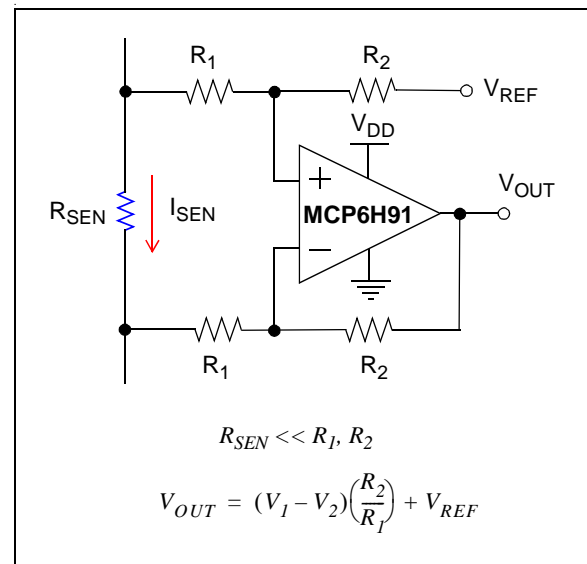

FIGURE 4-8: High Side Current Sensing Using Difference Amplifier.

MCP6H91/2/4

4.7.2 ACTIVE FULL-WAVE RECTIFIER

The MCP6H91/2/4 family of amplifiers can be used in applications such as an active full-wave rectifier, as shown in Figure 4-9. The amplifier and feedback loops in this active voltage rectifier circuit eliminate the diode drop problem that exists in a passive voltage rectifier. This circuit behaves as a voltage follower (the output follows the input) as long as the input signal is more positive than the reference voltage. If the input signal is more negative than the reference voltage, however, the circuit behaves as an inverting amplifier with a Gain = $-1V/V$. Therefore, the output voltage will always be above the reference voltage, regardless of the input signal. The reference voltage (V_{REF}) is supplied by a low-impedance source. In single-supply applications, V_{REF} is typically $V_{DD}/2$.



FIGURE 4-9: Active Full-Wave Rectifier.

4.7.3 LOSSY NON-INVERTING INTEGRATOR

The non-inverting integrator shown in Figure 4-10 is easy to build. It saves one op amp over the typical Miller integrator plus inverting amplifier configuration. The phase accuracy of this integrator depends on the matching of the input and feedback resistor-capacitor time constants. R_F makes this a lossy integrator (it has finite gain at DC), and makes this integrator stable by itself. To ensure proper operation, the op amp Common mode input voltage must be kept within the allowed range.

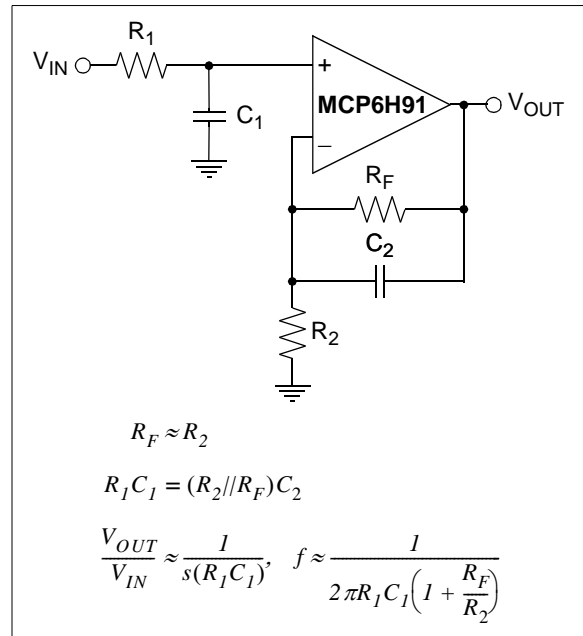

FIGURE 4-10: Non-Inverting Integrator.

5.0 DESIGN AIDS

Microchip Technology Inc. provides the basic design tools needed for the MCP6H91/2/4 family of op amps.

5.1 SPICE Macro Model

The latest SPICE macro model for the MCP6H91/2/4 op amp is available on the Microchip web site at www.microchip.com. The model was written and tested in PSpice, owned by Orcad (Cadence®). For other simulators, translation may be required.

The model covers a wide aspect of the op amp's electrical specifications. Not only does the model cover voltage, current and resistance of the op amp, but it also covers the temperature and noise effects on the behavior of the op amp. The model has not been verified outside the specification range listed in the op amp data sheet. The model behaviors under these conditions cannot be guaranteed to match the actual op amp performance.

Moreover, the model is intended to be an initial design tool. Bench testing is a very important part of any design and cannot be replaced with simulations. Also, simulation results using this macro model need to be validated by comparing them to the data sheet specifications and characteristic curves.

5.2 FilterLab® Software

Microchip's FilterLab® software is an innovative software tool that simplifies analog active filter (using op amps) design. Available at no cost from the Microchip web site at www.microchip.com/filterlab, the FilterLab® design tool provides full schematic diagrams of the filter circuit with component values. It also outputs the filter circuit in SPICE format, which can be used with the macro model to simulate actual filter performance.

5.3 MAPS (Microchip Advanced Part Selector)

MAPS is a software tool that helps semiconductor professionals efficiently identify Microchip devices that fit a particular design requirement. Available at no cost from the Microchip web site at www.microchip.com/maps, MAPS is an overall selection tool for Microchip's product portfolio that includes analog, memory, MCUs and DSCs. Using this tool, you can define a filter to sort features for a parametric search of devices and export side-by-side technical comparison reports. Helpful links are also provided for data sheets, purchases and sampling of Microchip parts.

5.4 Analog Demonstration and Evaluation Boards

Microchip offers a broad spectrum of Analog Demonstration and Evaluation Boards that are designed to help you achieve faster time to market. For a complete listing of these boards and their corresponding user's guides and technical information, visit the Microchip web site: www.microchip.com/analogtools.

Some boards that are especially useful include:

- MCP6XXX Amplifier Evaluation Board 1
- MCP6XXX Amplifier Evaluation Board 2
- MCP6XXX Amplifier Evaluation Board 3
- MCP6XXX Amplifier Evaluation Board 4
- Active Filter Demo Board Kit
- 5/6-Pin SOT-23 Evaluation Board, part number VSUPEV2
- 8-Pin SOIC/MSOP/TSSOP/DIP Evaluation Board, part number SOIC8EV

5.5 Application Notes

The following Microchip analog design note and application notes are available on the Microchip web site at www.microchip.com/appnotes, and are recommended as supplemental reference resources.

- **ADN003:** "Select the Right Operational Amplifier for your Filtering Circuits", DS21821
- **AN722:** "Operational Amplifier Topologies and DC Specifications", DS00722
- **AN723:** "Operational Amplifier AC Specifications and Applications", DS00723
- **AN884:** "Driving Capacitive Loads With Op Amps", DS00884
- **AN990:** "Analog Sensor Conditioning Circuits – An Overview", DS00990
- **AN1177:** "Op Amp Precision Design: DC Errors", DS01177
- **AN1228:** "Op Amp Precision Design: Random Noise", DS01228
- **AN1297:** "Microchip's Op Amp SPICE Macro Models" DS01297
- **AN1332:** "Current Sensing Circuit Concepts and Fundamentals" DS01332

These application notes and others are listed in:

- "Signal Chain Design Guide", DS21825

MCP6H91/2/4

NOTES:

6.0 PACKAGING INFORMATION

6.1 Package Marking Information

8-Lead SOIC (150 mil.) (MCP6H91, MCP6H92)



Example:



8-Lead 2x3 TDFN (MCP6H91, MCP6H92)



Part Number	Code
MCP6H91T-E/MNY	ABG
MCP6H92T-E/MNY	ABH

Example:

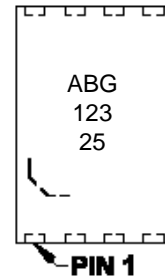

14-Lead SOIC (150 mil) (MCP6H94)

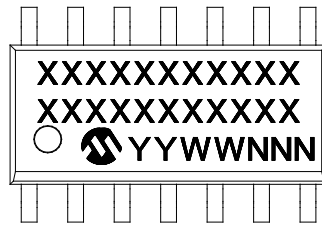

Example:

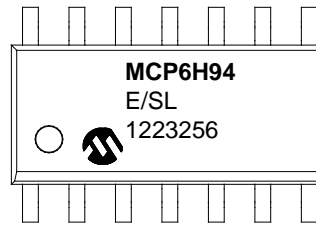

14-Lead TSSOP (MCP6H94)

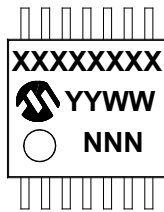

Example:

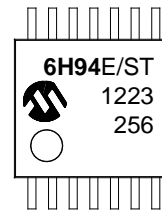

Legend:	XX...X	Customer-specific information
	Y	Year code (last digit of calendar year)
	YY	Year code (last 2 digits of calendar year)
	WW	Week code (week of January 1 is week '01')
	NNN	Alphanumeric traceability code
	(e3)	Pb-free JEDEC designator for Matte Tin (Sn)
	*	This package is Pb-free. The Pb-free JEDEC designator (e3) can be found on the outer packaging for this package.

Note: In the event the full Microchip part number cannot be marked on one line, it will be carried over to the next line, thus limiting the number of available characters for customer-specific information.

MCP6H91/2/4

8-Lead Plastic Small Outline (SN) - Narrow, 3.90 mm Body [SOIC]

Note: For the most current package drawings, please see the Microchip Packaging Specification located at <http://www.microchip.com/packaging>



Microchip Technology Drawing No. C04-057C Sheet 1 of 2

8-Lead Plastic Small Outline (SN) - Narrow, 3.90 mm Body [SOIC]

Note: For the most current package drawings, please see the Microchip Packaging Specification located at <http://www.microchip.com/packaging>

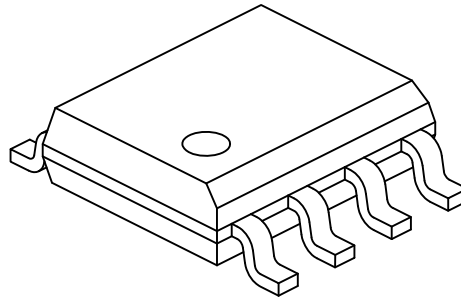

Dimension Limits	Units	MILLIMETERS		
		MIN	NOM	MAX
Number of Pins	N	8		
Pitch	e	1.27 BSC		
Overall Height	A	-	-	1.75
Molded Package Thickness	A2	1.25	-	-
Standoff §	A1	0.10	-	0.25
Overall Width	E	6.00 BSC		
Molded Package Width	E1	3.90 BSC		
Overall Length	D	4.90 BSC		
Chamfer (Optional)	h	0.25	-	0.50
Foot Length	L	0.40	-	1.27
Footprint	L1	1.04 REF		
Foot Angle	φ	0°	-	8°
Lead Thickness	c	0.17	-	0.25
Lead Width	b	0.31	-	0.51
Mold Draft Angle Top	α	5°	-	15°
Mold Draft Angle Bottom	β	5°	-	15°

Notes:

1. Pin 1 visual index feature may vary, but must be located within the hatched area.
2. § Significant Characteristic
3. Dimensions D and E1 do not include mold flash or protrusions. Mold flash or protrusions shall not exceed 0.15mm per side.
4. Dimensioning and tolerancing per ASME Y14.5M

BSC: Basic Dimension. Theoretically exact value shown without tolerances.

REF: Reference Dimension, usually without tolerance, for information purposes only.

Microchip Technology Drawing No. C04-057C Sheet 2 of 2

MCP6H91/2/4

8-Lead Plastic Small Outline (SN) – Narrow, 3.90 mm Body [SOIC]

Note: For the most current package drawings, please see the Microchip Packaging Specification located at <http://www.microchip.com/packaging>

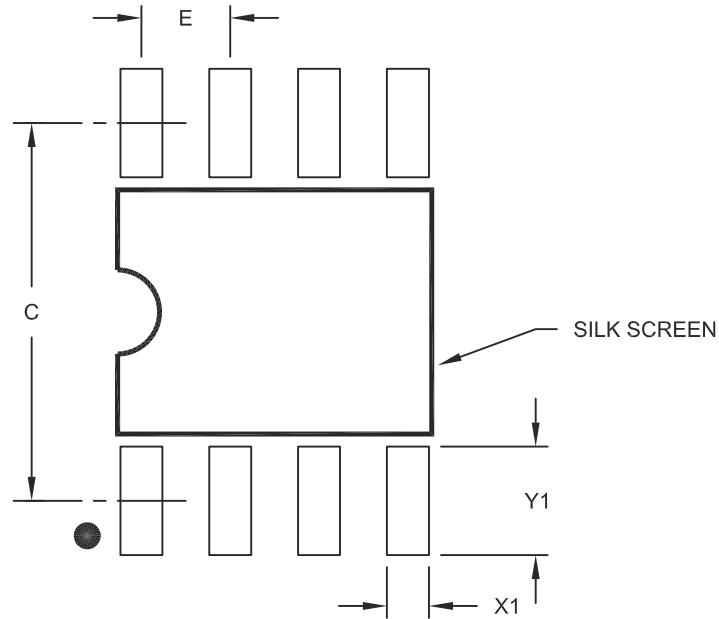

RECOMMENDED LAND PATTERN

Dimension Limits	Units	MILLIMETERS		
		MIN	NOM	MAX
Contact Pitch	E	1.27 BSC		
Contact Pad Spacing	C		5.40	
Contact Pad Width (X8)	X1			0.60
Contact Pad Length (X8)	Y1			1.55

Notes:

1. Dimensioning and tolerancing per ASME Y14.5M

BSC: Basic Dimension. Theoretically exact value shown without tolerances.

Microchip Technology Drawing No. C04-2057A

8-Lead Plastic Dual Flat, No Lead Package (MN) – 2x3x0.75mm Body [TDFN]

Note: For the most current package drawings, please see the Microchip Packaging Specification located at <http://www.microchip.com/packaging>



Microchip Technology Drawing No. C04-129C Sheet 1 of 2

MCP6H91/2/4

8-Lead Plastic Dual Flat, No Lead Package (MN) – 2x3x0.75mm Body [TDFN]

Note: For the most current package drawings, please see the Microchip Packaging Specification located at <http://www.microchip.com/packaging>



Dimension Limits	Units	MILLIMETERS		
		MIN	NOM	MAX
Number of Pins	N	8		
Pitch	e	0.50 BSC		
Overall Height	A	0.70	0.75	0.80
Standoff	A1	0.00	0.02	0.05
Contact Thickness	A3	0.20 REF		
Overall Length	D	2.00 BSC		
Overall Width	E	3.00 BSC		
Exposed Pad Length	D2	1.20	-	1.60
Exposed Pad Width	E2	1.20	-	1.60
Contact Width	b	0.20	0.25	0.30
Contact Length	L	0.25	0.30	0.45
Contact-to-Exposed Pad	K	0.20	-	-

Notes:

1. Pin 1 visual index feature may vary, but must be located within the hatched area.
2. Package may have one or more exposed tie bars at ends.
3. Package is saw singulated
4. Dimensioning and tolerancing per ASME Y14.5M

BSC: Basic Dimension. Theoretically exact value shown without tolerances.

REF: Reference Dimension, usually without tolerance, for information purposes only.

Microchip Technology Drawing No. C04-129C Sheet 2 of 2

8-Lead Plastic Dual Flat, No Lead Package (MN) – 2x3x0.75 mm Body [TDFN]

Note: For the most current package drawings, please see the Microchip Packaging Specification located at <http://www.microchip.com/packaging>



RECOMMENDED LAND PATTERN

Dimension Limits	Units	MILLIMETERS		
		MIN	NOM	MAX
Contact Pitch	E	0.50 BSC		
Optional Center Pad Width	W2			1.46
Optional Center Pad Length	T2			1.36
Contact Pad Spacing	C1		3.00	
Contact Pad Width (X8)	X1			0.30
Contact Pad Length (X8)	Y1			0.75
Distance Between Pads	G	0.20		

Notes:

1. Dimensioning and tolerancing per ASME Y14.5M

BSC: Basic Dimension. Theoretically exact value shown without tolerances.

Microchip Technology Drawing No. C04-2129A

MCP6H91/2/4

14-Lead Plastic Small Outline (OD) - Narrow, 3.90 mm Body [SOIC]

Note: For the most current package drawings, please see the Microchip Packaging Specification located at <http://www.microchip.com/packaging>



Microchip Technology Drawing No. C04-065C Sheet 1 of 2

14-Lead Plastic Small Outline (SL) - Narrow, 3.90 mm Body [SOIC]

Note: For the most current package drawings, please see the Microchip Packaging Specification located at <http://www.microchip.com/packaging>

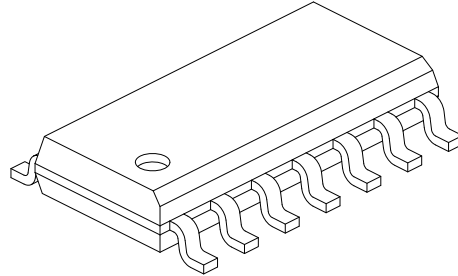
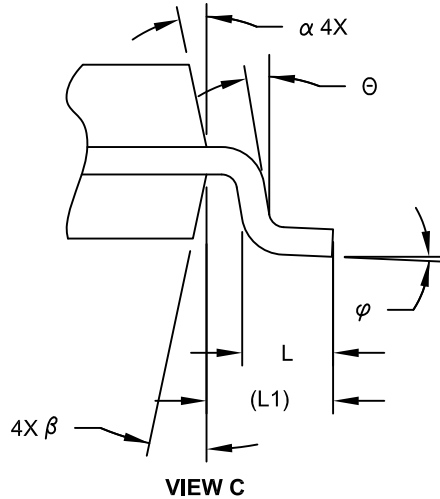

Dimension Limits	Units	MILLIMETERS		
		MIN	NOM	MAX
Number of Pins	N	14		
Pitch	e	1.27 BSC		
Overall Height	A	-	-	1.75
Molded Package Thickness	A2	1.25	-	-
Standoff §	A1	0.10	-	0.25
Overall Width	E	6.00 BSC		
Molded Package Width	E1	3.90 BSC		
Overall Length	D	8.65 BSC		
Chamfer (Optional)	h	0.25	-	0.50
Foot Length	L	0.40	-	1.27
Footprint	L1	1.04 REF		
Lead Angle	θ	0°	-	-
Foot Angle	φ	0°	-	8°
Lead Thickness	c	0.10	-	0.25
Lead Width	b	0.31	-	0.51
Mold Draft Angle Top	α	5°	-	15°
Mold Draft Angle Bottom	β	5°	-	15°

Notes:

- Pin 1 visual index feature may vary, but must be located within the hatched area.
- § Significant Characteristic
- Dimension D does not include mold flash, protrusions or gate burrs, which shall not exceed 0.15 mm per end. Dimension E1 does not include interlead flash or protrusion, which shall not exceed 0.25 mm per side.
- Dimensioning and tolerancing per ASME Y14.5M
 BSC: Basic Dimension. Theoretically exact value shown without tolerances.
 REF: Reference Dimension, usually without tolerance, for information purposes only.
- Datums A & B to be determined at Datum H.

Microchip Technology Drawing No. C04-065C Sheet 2 of 2

MCP6H91/2/4

14-Lead Plastic Small Outline (SL) - Narrow, 3.90 mm Body [SOIC]

Note: For the most current package drawings, please see the Microchip Packaging Specification located at <http://www.microchip.com/packaging>



RECOMMENDED LAND PATTERN

Dimension Limits	Units	MILLIMETERS		
		MIN	NOM	MAX
Contact Pitch	E	1.27 BSC		
Contact Pad Spacing	C		5.40	
Contact Pad Width	X			0.60
Contact Pad Length	Y			1.50
Distance Between Pads	Gx	0.67		
Distance Between Pads	G	3.90		

Notes:

1. Dimensioning and tolerancing per ASME Y14.5M

BSC: Basic Dimension. Theoretically exact value shown without tolerances.

Microchip Technology Drawing No. C04-2065A

14-Lead Plastic Thin Shrink Small Outline (ST) - 4.4 mm Body [TSSOP]

Note: For the most current package drawings, please see the Microchip Packaging Specification located at <http://www.microchip.com/packaging>

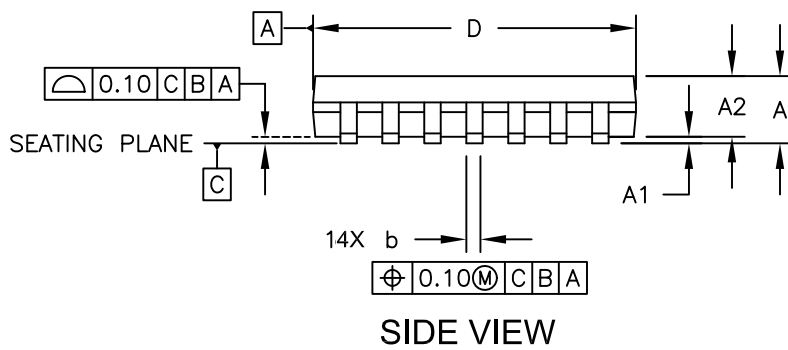
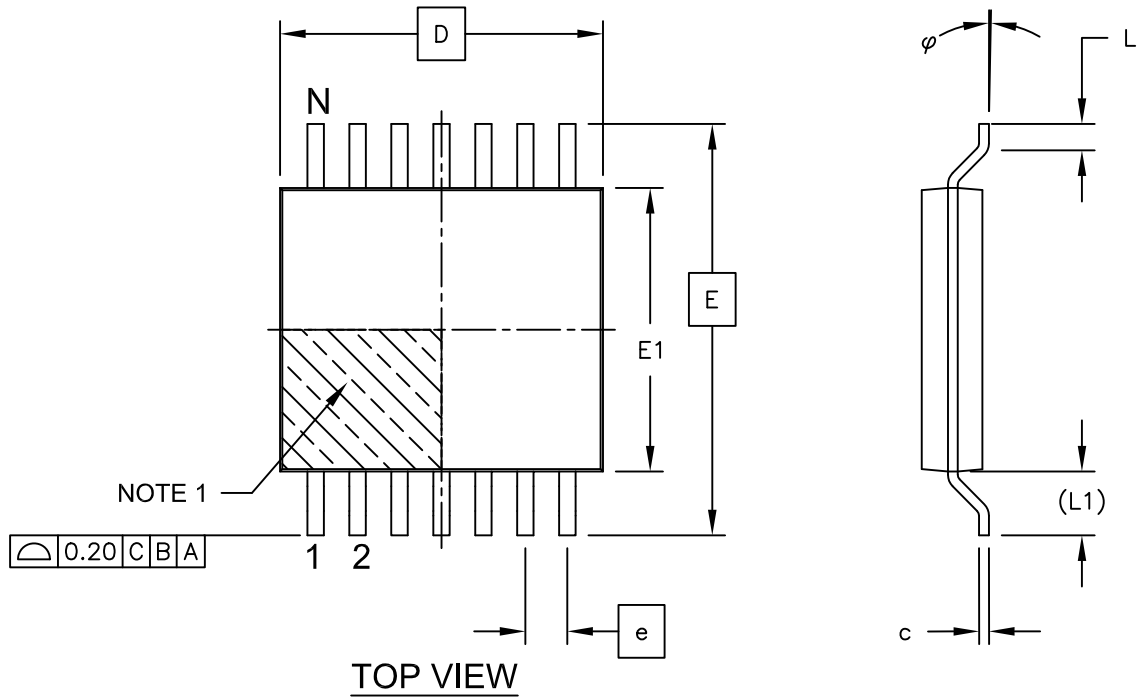

MCP6H91/2/4

14-Lead Plastic Thin Shrink Small Outline (ST) - 4.4 mm Body [TSSOP]

Note: For the most current package drawings, please see the Microchip Packaging Specification located at <http://www.microchip.com/packaging>

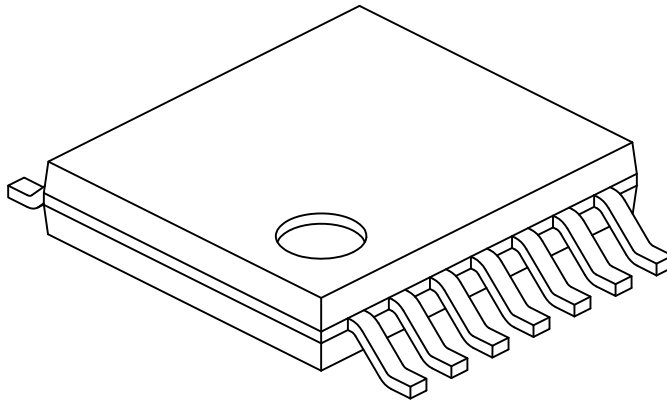

Dimension Limits	Units	MILLIMETERS		
		MIN	NOM	MAX
Number of Pins	N	14		
Pitch	e	0.65 BSC		
Overall Height	A	-	-	1.20
Molded Package Thickness	A2	0.80	1.00	1.05
Standoff	A1	0.05	-	0.15
Overall Width	E	6.40 BSC		
Molded Package Width	E1	4.30	4.40	4.50
Molded Package Length	D	4.90	5.00	5.10
Foot Length	L	0.45	0.60	0.75
Footprint	(L1)	1.00 REF		
Foot Angle	φ	0°	-	8°
Lead Thickness	c	0.09	-	0.20
Lead Width	b	0.19	-	0.30

Notes:

1. Pin 1 visual index feature may vary, but must be located within the hatched area.
2. Dimensions D and E1 do not include mold flash or protrusions. Mold flash or protrusions shall not exceed 0.15mm per side.
3. Dimensioning and tolerancing per ASME Y14.5M

BSC: Basic Dimension. Theoretically exact value shown without tolerances.

REF: Reference Dimension, usually without tolerance, for information purposes only.

Microchip Technology Drawing No. C04-087C Sheet 2 of 2

14-Lead Plastic Thin Shrink Small Outline (ST) - 4.4 mm Body [TSSOP]

Note: For the most current package drawings, please see the Microchip Packaging Specification located at <http://www.microchip.com/packaging>

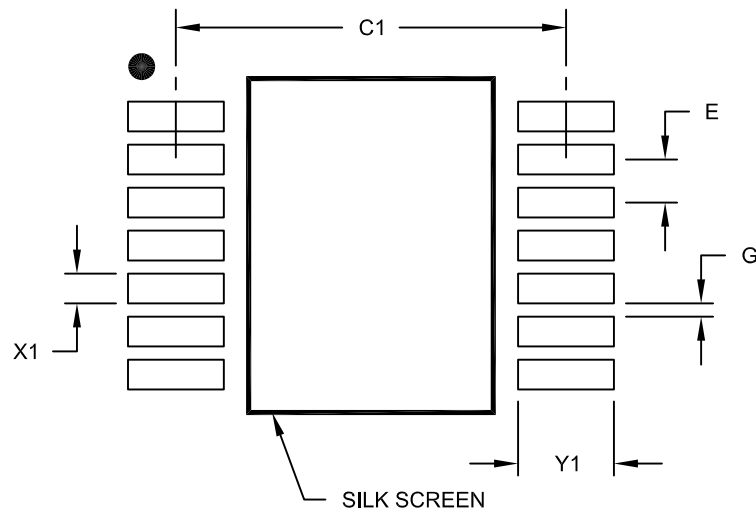

RECOMMENDED LAND PATTERN

Dimension Limits	Units	MILLIMETERS		
		MIN	NOM	MAX
Contact Pitch	E	0.65 BSC		
Contact Pad Spacing	C1		5.90	
Contact Pad Width (X14)	X1			0.45
Contact Pad Length (X14)	Y1			1.45
Distance Between Pads	G	0.20		

Notes:

1. Dimensioning and tolerancing per ASME Y14.5M

BSC: Basic Dimension. Theoretically exact value shown without tolerances.

Microchip Technology Drawing No. C04-2087A

MCP6H91/2/4

NOTES:

APPENDIX A: REVISION HISTORY

Revision B (December 2012)

The following is the list of modifications:

- Updated the $V_{DD} - V_{SS}$ value in the [Absolute Maximum Ratings](#) † section.

Revision A (June 2012)

- Original Release of this Document.

MCP6H91/2/4

NOTES:

PRODUCT IDENTIFICATION SYSTEM

To order or obtain information, e.g., on pricing or delivery, refer to the factory or the listed sales office.

<u>PART NO.</u>	<u>-X</u>	<u>/XX</u>	Examples:
Device	Temperature Range	Package	
Device:	MCP6H91:	Single Op Amp	a) MCP6H91-E/SN: 8LD SOIC pkg., Extended Temp.
	MCP6H91T:	Single Op Amp (Tape and Reel) (SOIC and 2x3 TDFN)	b) MCP6H91T-E/SN: Tape and Reel, Extended Temp., 8LD SOIC pkg.
	MCP6H92:	Dual Op Amp	c) MCP6H91T-E/MNY: Tape and Reel, Extended Temp., 8LD 2x3 TDFN pkg.
	MCP6H92T:	Dual Op Amp (Tape and Reel) (SOIC and 2x3 TDFN)	d) MCP6H92-E/SN: Extended Temp., 8LD SOIC pkg.
	MCP6H94:	Quad Op Amp	e) MCP6H92T-E/SN: Tape and Reel, Extended Temp., 8LD SOIC pkg.
	MCP6H94T:	Quad Op Amp (Tape and Reel) (SOIC and TSSOP)	f) MCP6H92T-E/MNY: Tape and Reel, Extended Temp., 8LD 2x3 TDFN pkg.
Temperature Range:	E	= -40°C to +125°C (Extended)	g) MCP6H94-E/SL: Extended Temp., 14LD SOIC pkg.
Package:	MNY *	= Plastic Dual Flat, No Lead, (2x3 TDFN) 8-lead (TDFN)	h) MCP6H94T-E/SL: Tape and Reel, Extended Temp., 14LD SOIC pkg.
	SN	= Lead Plastic Small Outline (150 mil Body), 8-lead (SOIC)	i) MCP6H94-E/ST: Extended Temp., 14LD TSSOP pkg.
	SL	= Plastic Small Outline, (150 mil Body), 14-lead (SOIC)	j) MCP6H94T-E/ST: Tape and Reel, Extended Temp., 14LD TSSOP pkg.
	ST	= Plastic Thin Shrink Small Outline (150 mil Body), 14-lead (TSSOP)	
	* Y = Nickel palladium gold manufacturing designator. Only available on the TDFN package.		

MCP6H91/2/4

NOTES:

Note the following details of the code protection feature on Microchip devices:

- Microchip products meet the specification contained in their particular Microchip Data Sheet.
- Microchip believes that its family of products is one of the most secure families of its kind on the market today, when used in the intended manner and under normal conditions.
- There are dishonest and possibly illegal methods used to breach the code protection feature. All of these methods, to our knowledge, require using the Microchip products in a manner outside the operating specifications contained in Microchip's Data Sheets. Most likely, the person doing so is engaged in theft of intellectual property.
- Microchip is willing to work with the customer who is concerned about the integrity of their code.
- Neither Microchip nor any other semiconductor manufacturer can guarantee the security of their code. Code protection does not mean that we are guaranteeing the product as “unbreakable.”

Code protection is constantly evolving. We at Microchip are committed to continuously improving the code protection features of our products. Attempts to break Microchip's code protection feature may be a violation of the Digital Millennium Copyright Act. If such acts allow unauthorized access to your software or other copyrighted work, you may have a right to sue for relief under that Act.

Information contained in this publication regarding device applications and the like is provided only for your convenience and may be superseded by updates. It is your responsibility to ensure that your application meets with your specifications. MICROCHIP MAKES NO REPRESENTATIONS OR WARRANTIES OF ANY KIND WHETHER EXPRESS OR IMPLIED, WRITTEN OR ORAL, STATUTORY OR OTHERWISE, RELATED TO THE INFORMATION, INCLUDING BUT NOT LIMITED TO ITS CONDITION, QUALITY, PERFORMANCE, MERCHANTABILITY OR FITNESS FOR PURPOSE. Microchip disclaims all liability arising from this information and its use. Use of Microchip devices in life support and/or safety applications is entirely at the buyer's risk, and the buyer agrees to defend, indemnify and hold harmless Microchip from any and all damages, claims, suits, or expenses resulting from such use. No licenses are conveyed, implicitly or otherwise, under any Microchip intellectual property rights.

Trademarks

The Microchip name and logo, the Microchip logo, dsPIC, FlashFlex, KEELOQ, KEELOQ logo, MPLAB, PIC, PICmicro, PICSTART, PIC³² logo, rPIC, SST, SST Logo, SuperFlash and UNI/O are registered trademarks of Microchip Technology Incorporated in the U.S.A. and other countries.

FilterLab, Hampshire, HI-TECH C, Linear Active Thermistor, MTP, SEEVAL and The Embedded Control Solutions Company are registered trademarks of Microchip Technology Incorporated in the U.S.A.

Silicon Storage Technology is a registered trademark of Microchip Technology Inc. in other countries.

Analog-for-the-Digital Age, Application Maestro, BodyCom, chipKIT, chipKIT logo, CodeGuard, dsPICDEM, dsPICDEM.net, dsPICworks, dsSPEAK, ECAN, ECONOMONITOR, FanSense, HI-TIDE, In-Circuit Serial Programming, ICSP, Mindi, MiWi, MPASM, MPF, MPLAB Certified logo, MPLIB, MPLINK, mTouch, Omniclient Code Generation, PICC, PICC-18, PICDEM, PICDEM.net, PICkit, PICTail, REAL ICE, rLAB, Select Mode, SQI, Serial Quad I/O, Total Endurance, TSHARC, UniWinDriver, WiperLock, ZENA and Z-Scale are trademarks of Microchip Technology Incorporated in the U.S.A. and other countries.

SQTP is a service mark of Microchip Technology Incorporated in the U.S.A.

GestIC and ULPP are registered trademarks of Microchip Technology Germany II GmbH & Co. & KG, a subsidiary of Microchip Technology Inc., in other countries.

All other trademarks mentioned herein are property of their respective companies.

© 2012, Microchip Technology Incorporated, Printed in the U.S.A., All Rights Reserved.

 Printed on recycled paper.

ISBN: 978-1-62076-758-0

QUALITY MANAGEMENT SYSTEM
CERTIFIED BY DNV
== ISO/TS 16949 ==

Microchip received ISO/TS-16949:2009 certification for its worldwide headquarters, design and wafer fabrication facilities in Chandler and Tempe, Arizona; Gresham, Oregon and design centers in California and India. The Company's quality system processes and procedures are for its PIC[®] MCUs and dsPIC[®] DSCs, KEELOQ[®] code hopping devices, Serial EEPROMs, microperipherals, nonvolatile memory and analog products. In addition, Microchip's quality system for the design and manufacture of development systems is ISO 9001:2000 certified.



MICROCHIP

Worldwide Sales and Service

AMERICAS

Corporate Office
2355 West Chandler Blvd.
Chandler, AZ 85224-6199
Tel: 480-792-7200
Fax: 480-792-7277
Technical Support:
<http://www.microchip.com/support>
Web Address:
www.microchip.com

Atlanta
Duluth, GA
Tel: 678-957-9614
Fax: 678-957-1455

Boston
Westborough, MA
Tel: 774-760-0087
Fax: 774-760-0088

Chicago
Itasca, IL
Tel: 630-285-0071
Fax: 630-285-0075

Cleveland
Independence, OH
Tel: 216-447-0464
Fax: 216-447-0643

Dallas
Addison, TX
Tel: 972-818-7423
Fax: 972-818-2924

Detroit
Farmington Hills, MI
Tel: 248-538-2250
Fax: 248-538-2260

Indianapolis
Noblesville, IN
Tel: 317-773-8323
Fax: 317-773-5453

Los Angeles
Mission Viejo, CA
Tel: 949-462-9523
Fax: 949-462-9608

Santa Clara
Santa Clara, CA
Tel: 408-961-6444
Fax: 408-961-6445

Toronto
Mississauga, Ontario,
Canada
Tel: 905-673-0699
Fax: 905-673-6509

ASIA/PACIFIC

Asia Pacific Office
Suites 3707-14, 37th Floor
Tower 6, The Gateway
Harbour City, Kowloon
Hong Kong
Tel: 852-2401-1200
Fax: 852-2401-3431

Australia - Sydney
Tel: 61-2-9868-6733
Fax: 61-2-9868-6755

China - Beijing
Tel: 86-10-8569-7000
Fax: 86-10-8528-2104

China - Chengdu
Tel: 86-28-8665-5511
Fax: 86-28-8665-7889

China - Chongqing
Tel: 86-23-8980-9588
Fax: 86-23-8980-9500

China - Hangzhou
Tel: 86-571-2819-3187
Fax: 86-571-2819-3189

China - Hong Kong SAR
Tel: 852-2943-5100
Fax: 852-2401-3431

China - Nanjing
Tel: 86-25-8473-2460
Fax: 86-25-8473-2470

China - Qingdao
Tel: 86-532-8502-7355
Fax: 86-532-8502-7205

China - Shanghai
Tel: 86-21-5407-5533
Fax: 86-21-5407-5066

China - Shenyang
Tel: 86-24-2334-2829
Fax: 86-24-2334-2393

China - Shenzhen
Tel: 86-755-8864-2200
Fax: 86-755-8203-1760

China - Wuhan
Tel: 86-27-5980-5300
Fax: 86-27-5980-5118

China - Xian
Tel: 86-29-8833-7252
Fax: 86-29-8833-7256

China - Xiamen
Tel: 86-592-2388138
Fax: 86-592-2388130

China - Zhuhai
Tel: 86-756-3210040
Fax: 86-756-3210049

ASIA/PACIFIC

India - Bangalore
Tel: 91-80-3090-4444
Fax: 91-80-3090-4123

India - New Delhi
Tel: 91-11-4160-8631
Fax: 91-11-4160-8632

India - Pune
Tel: 91-20-2566-1512
Fax: 91-20-2566-1513

Japan - Osaka
Tel: 81-6-6152-7160
Fax: 81-6-6152-9310

Japan - Tokyo
Tel: 81-3-6880-3770
Fax: 81-3-6880-3771

Korea - Daegu
Tel: 82-53-744-4301
Fax: 82-53-744-4302

Korea - Seoul
Tel: 82-2-554-7200
Fax: 82-2-558-5932 or
82-2-558-5934

Malaysia - Kuala Lumpur
Tel: 60-3-6201-9857
Fax: 60-3-6201-9859

Malaysia - Penang
Tel: 60-4-227-8870
Fax: 60-4-227-4068

Philippines - Manila
Tel: 63-2-634-9065
Fax: 63-2-634-9069

Singapore
Tel: 65-6334-8870
Fax: 65-6334-8850

Taiwan - Hsin Chu
Tel: 886-3-5778-366
Fax: 886-3-5770-955

Taiwan - Kaohsiung
Tel: 886-7-213-7828
Fax: 886-7-330-9305

Taiwan - Taipei
Tel: 886-2-2508-8600
Fax: 886-2-2508-0102

Thailand - Bangkok
Tel: 66-2-694-1351
Fax: 66-2-694-1350

EUROPE

Austria - Wels
Tel: 43-7242-2244-39
Fax: 43-7242-2244-393

Denmark - Copenhagen
Tel: 45-4450-2828
Fax: 45-4485-2829

France - Paris
Tel: 33-1-69-53-63-20
Fax: 33-1-69-30-90-79

Germany - Munich
Tel: 49-89-627-144-0
Fax: 49-89-627-144-44

Italy - Milan
Tel: 39-0331-742611
Fax: 39-0331-466781

Netherlands - Drunen
Tel: 31-416-690399
Fax: 31-416-690340

Spain - Madrid
Tel: 34-91-708-08-90
Fax: 34-91-708-08-91

UK - Wokingham
Tel: 44-118-921-5869
Fax: 44-118-921-5820

11/29/12

Компания «Океан Электроники» предлагает заключение долгосрочных отношений при поставках импортных электронных компонентов на взаимовыгодных условиях!

Наши преимущества:

- Поставка оригинальных импортных электронных компонентов напрямую с производств Америки, Европы и Азии, а так же с крупнейших складов мира;
- Широкая линейка поставок активных и пассивных импортных электронных компонентов (более 30 млн. наименований);
- Поставка сложных, дефицитных, либо снятых с производства позиций;
- Оперативные сроки поставки под заказ (от 5 рабочих дней);
- Экспресс доставка в любую точку России;
- Помощь Конструкторского Отдела и консультации квалифицированных инженеров;
- Техническая поддержка проекта, помощь в подборе аналогов, поставка прототипов;
- Поставка электронных компонентов под контролем ВП;
- Система менеджмента качества сертифицирована по Международному стандарту ISO 9001;
- При необходимости вся продукция военного и аэрокосмического назначения проходит испытания и сертификацию в лаборатории (по согласованию с заказчиком);
- Поставка специализированных компонентов военного и аэрокосмического уровня качества (Xilinx, Altera, Analog Devices, Intersil, Interpoint, Microsemi, Actel, Aeroflex, Peregrine, VPT, Syfer, Eurofarad, Texas Instruments, MS Kennedy, Miteq, Cobham, E2V, MA-COM, Hittite, Mini-Circuits, General Dynamics и др.);

Компания «Океан Электроники» является официальным дистрибьютором и эксклюзивным представителем в России одного из крупнейших производителей разъемов военного и аэрокосмического назначения «JONHON», а так же официальным дистрибьютором и эксклюзивным представителем в России производителя высокотехнологичных и надежных решений для передачи СВЧ сигналов «FORSTAR».



JONHON

«JONHON» (основан в 1970 г.)

Разъемы специального, военного и аэрокосмического назначения:

(Применяются в военной, авиационной, аэрокосмической, морской, железнодорожной, горно- и нефтедобывающей отраслях промышленности)

«FORSTAR» (основан в 1998 г.)

ВЧ соединители, коаксиальные кабели, кабельные сборки и микроволновые компоненты:

(Применяются в телекоммуникациях гражданского и специального назначения, в средствах связи, РЛС, а так же военной, авиационной и аэрокосмической отраслях промышленности).



Телефон: 8 (812) 309-75-97 (многоканальный)

Факс: 8 (812) 320-03-32

Электронная почта: ocean@oceanchips.ru

Web: <http://oceanchips.ru/>

Адрес: 198099, г. Санкт-Петербург, ул. Калинина, д. 2, корп. 4, лит. А