

This document is the property of Amphenol Corporation and is delivered on the express condition that it is not to be disclosed, reproduced or used, in whole or in part, for manufacture or sale by anyone other than Amphenol Corporation without its prior consent, & that no right is granted to disclose or to use any information in this document.

CUSTOMER DRAWING

REVISIONS				
SYM	ECN	DESCRIPTION	DATE	APPROVED
7	CD1275	UPDATE DRAWING	Apr.25,2018	

PART NUMBER SYSTEM
CEXXXXXXXX011011X

SIGNAL SPEED/IMPEDANCE
1: BELOW 16Gbps
2: 16~32Gbps WITH 85 ohm

CARD THICKNESS
0: 1.60MM

PLATING SPEC
1: 0.76um Au
2: 0.38um Au
3: GOLD FLASH
4: 0.76umPdNi +GF

GUIDE HOLE
0: WITHOUT GUIDE HOLE
G: WITH GUIDE HOLE

POWER PIN COUNT
0: WITHOUT POWER PIN
2: 2PIN
4: 4PIN
6: 6PIN

SIGNAL PIN COUNT
000: 0 PIN ; 080: 80PIN
020: 20PIN ; 100: 100PIN
026: 26PIN ; 120: 120PIN
040: 40PIN ; 140: 140PIN
050: 50PIN ; 160: 160PIN
060: 60PIN ; 180: 180PIN
200: 200PIN

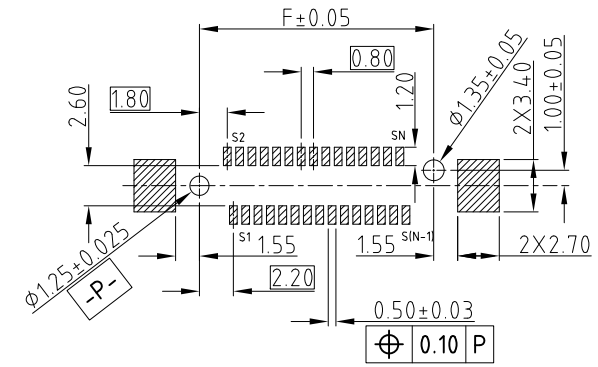
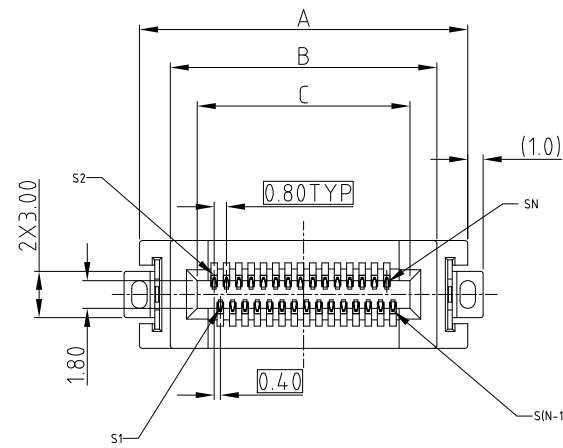

RECOMMEND SOLDER PCB LAYOUT
GENERAL TOLERANCE ±0.05MM

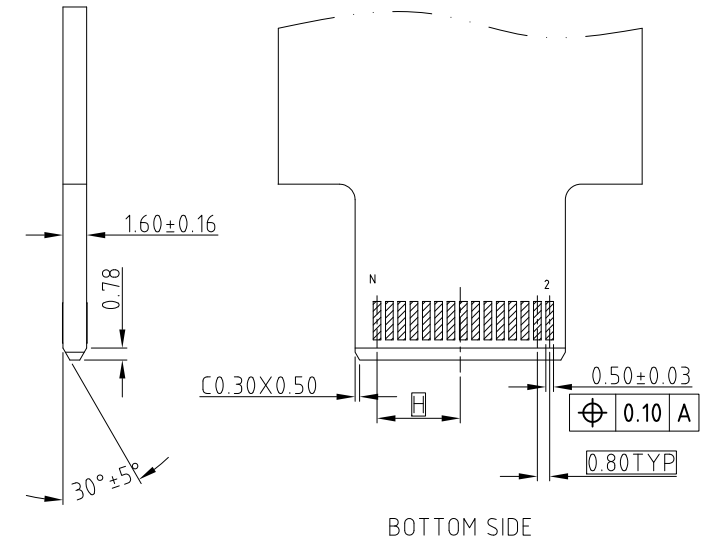
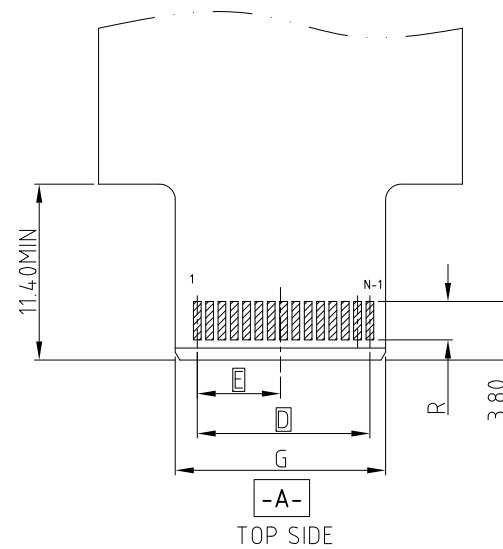
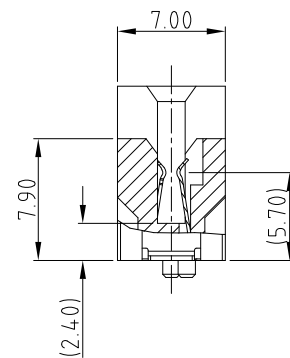
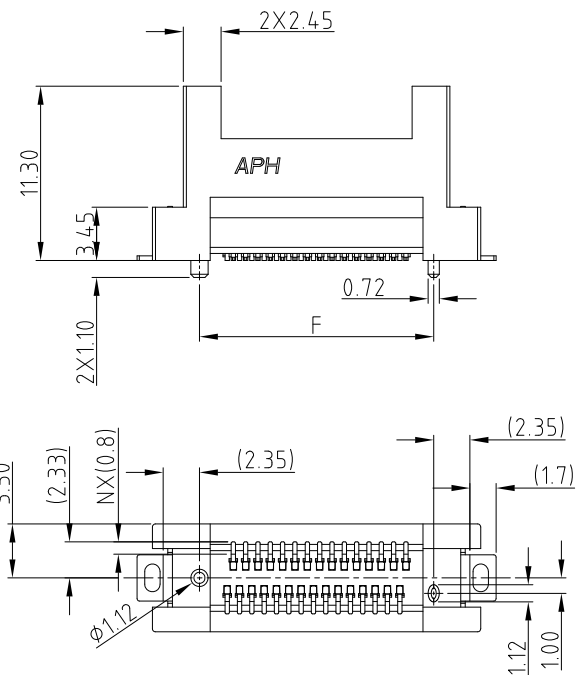

RECOMMEND MATING CARD, THICKNESS=1.60±0.16MM
GENERAL TOLERANCE ±0.05MM



SYSTEM	DIM R
IMPEDANCE	(GOLD FINGER LENGTH)
85 ohm	2.50

PIN COUNT	DIMENSION							
	A	B	C	D	E	F	G	H
N (SIGNAL)								
20	17.30	13.30	9.80	7.20	3.40	11.20	9.65	3.40
26	19.70	15.70	12.20	9.60	4.60	13.60	12.05	4.60
40	25.30	21.30	17.80	15.20	7.40	19.20	17.65	7.40
50	29.30	25.30	21.80	19.20	9.40	23.20	21.65	9.40

NOTE:

- MATERIAL:
HOUSING: HIGH TEMPERATURE THERMOPLASTIC BLACK UL94-V0
CONTACT: COPPER ALLOY
BOARDLOCK: SPCC
- PLATING:
CONTACT: MATING AREA: SEE PLATING SEPC OVER 1.27-2.54 UM NICKEL UNDERPLATED
SOLDER AREA: 1.27 MIN TIN OVER 1.27-2.54 UM NICKEL UNDERPLATED
BOARDLOCK: 1.27 MIN TIN OVER 1.27-2.54UM NICKEL UNDERPLATED
- ELECTRICAL PERFORMANCE:
RATED CURRENT FOR POWER PIN: REFER PRODUCT APPLICATION SPEC
RATED CURRENT FOR SIGNAL PIN: REFER PRODUCT APPLICATION SPEC
- PRODUCT SHALL MEET ALL DIMENSIONS BEFORE EXPOSURE TO 260°C MAX. FOR 10S AND SHALL MEET ALL SELECTED FUNCTIONAL DIMENSION AFTER EXPOSURE TO 260°C MAX. FOR 10S.
- MATERIAL SHOULD BE FULFILLED AMPHENOL SPEC # SSN002
- ORDERING PN: REFER TO THE PN SYSTEM

UNLESS OTHERWISE SPECIFIED TOLERANCES	
U.S.	METRIC
.X +/-	0.25
.XX +/-	0.20
.XXX +/-	0.15
FRACTIONS +/-	5°
ANGLES +/-	

APPROVAL	DATE
DRAWN	Apr.25,2018
CHECKED	
APPROVED	
DRAWING FILE : INTERNAL\DRAWING\CE\C CEXXXXXX011011X	
REMOVE SHARP EDGES	
ANGLE OF PROJECTION	
DIMENSIONS	
—U.S.—	INCHES
(METRIC)	(mm)

Amphenol

TITLE
**COOL EDGE CONNECTOR
0.80MM PITCH**

SIZE	DRAWING NO.	REV.
A3	C CEXXXXXX011011X	7
SCALE	NONE	SHEET 1 OF 8

This document is the property of Amphenol Corporation and is delivered on the express condition that it is not to be disclosed, reproduced or used, in whole or in part, for manufacture or sale by anyone other than Amphenol Corporation without its prior consent, & that no right is granted to disclose or to use any information in this document.

CUSTOMER DRAWING

REVISIONS				
SYM	ECN	DESCRIPTION	DATE	APPROVED
		SEE SHEET 1		

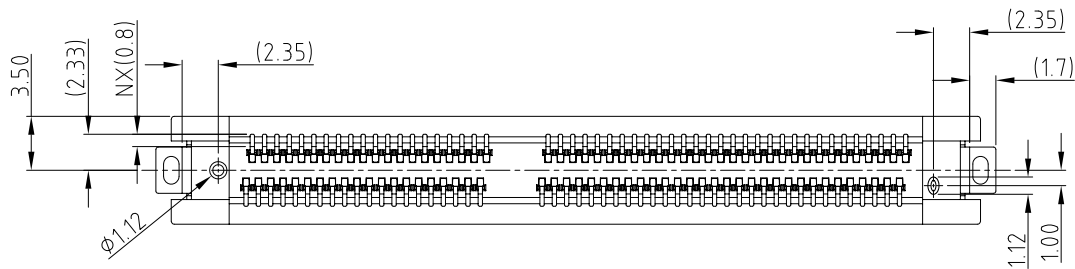
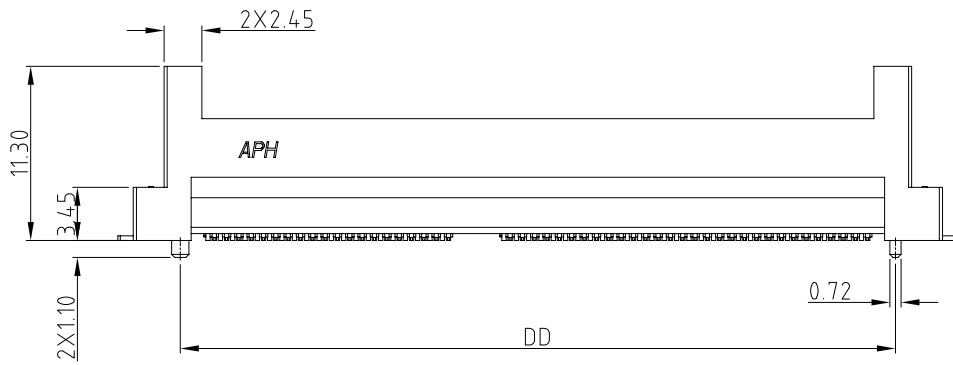
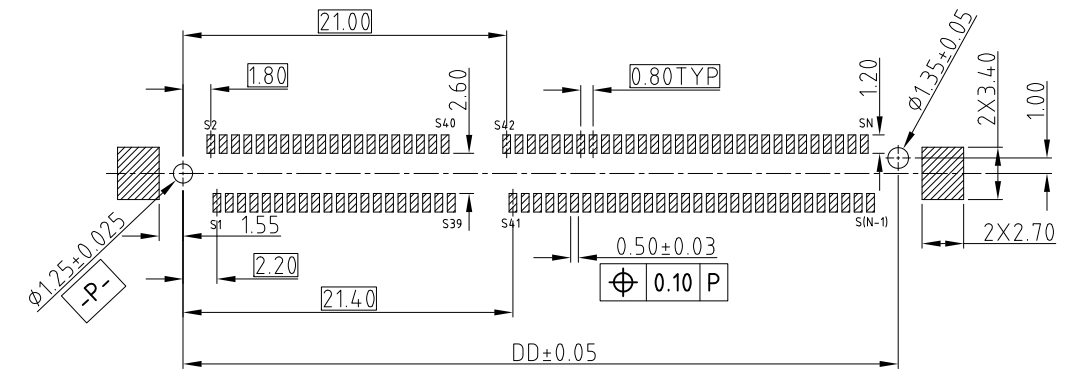
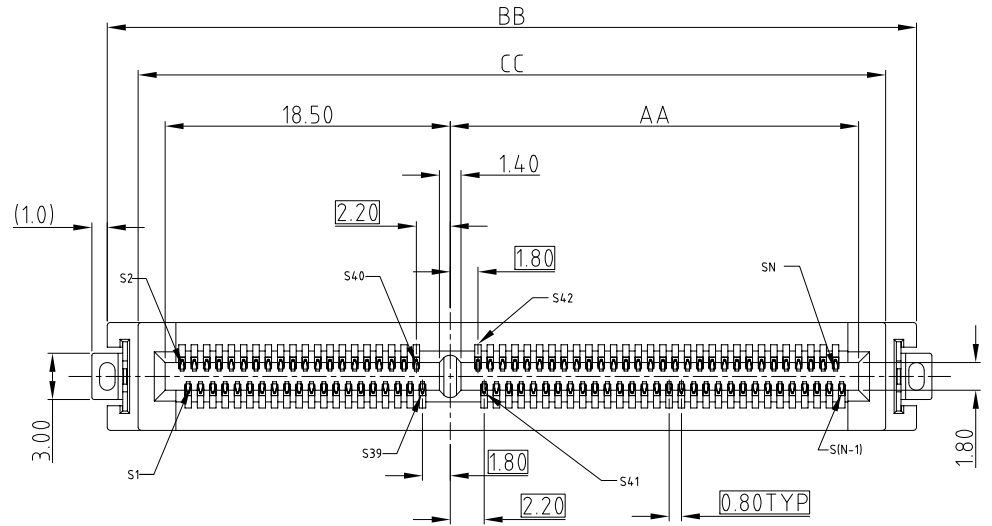

UNLESS OTHERWISE SPECIFIED TOLERANCES	
U.S.	METRIC
.X +/-	0.25
.XX +/-	0.20
.XXX +/-	0.15
FRACTIONS +/-	5°
ANGLES +/-	

APPROVAL	DATE
DRAWN	Apr.25,2018
CHECKED	
APPROVED	
DRAWING FILE :	
INTERNAL\DRAWING\CE\C CEXXXXXX011011X	
ANGLE OF PROJECTION	

Amphenol		
TITLE		
COOL EDGE CONNECTOR 0.80MM PITCH		
SIZE	DRAWING NO.	REV.
A3	C CEXXXXXX011011X	7
SCALE	NONE	SHEET 2 OF 8

This document is the property of Amphenol Corporation and is delivered on the express condition that it is not to be disclosed, reproduced or used, in whole or in part, for manufacture or sale by anyone other than Amphenol Corporation without its prior consent, & that no right is granted to disclose or to use any information in this document.

CUSTOMER DRAWING

REVISIONS				
SYM	ECN	DESCRIPTION	DATE	APPROVED
		SEE SHEET 1		

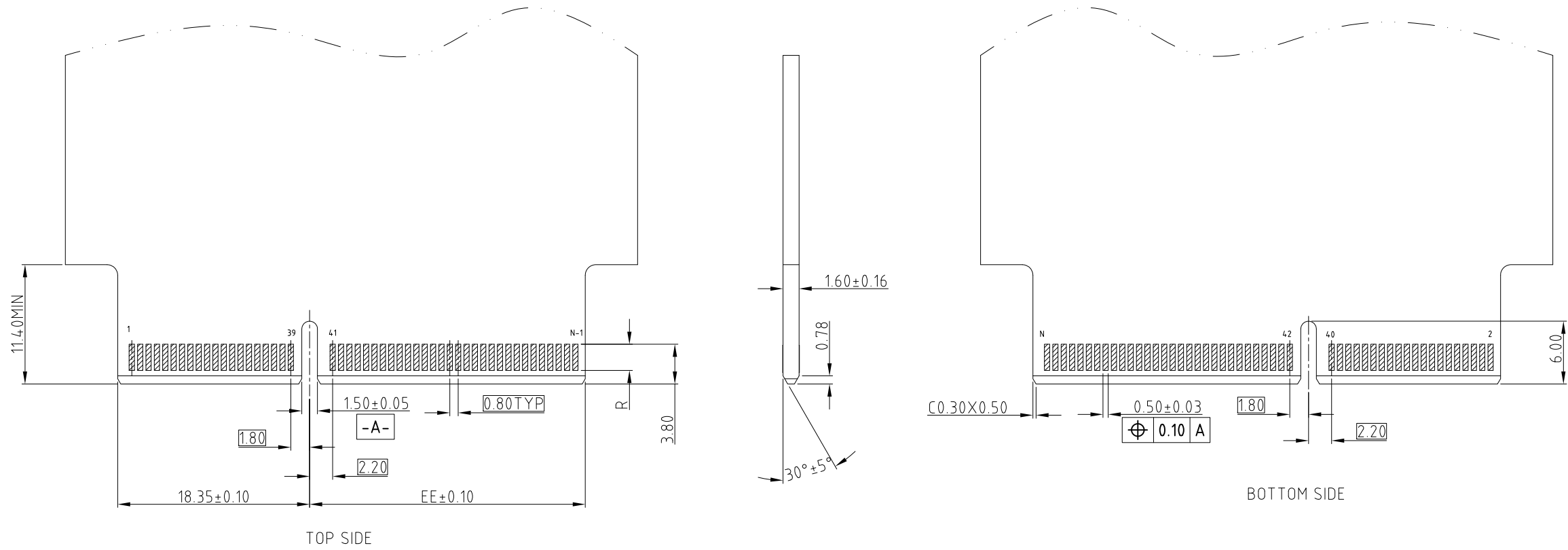

RECOMMENDED LAY OUT FOR MATING CARD, THICKNESS=1.60±0.16
GENERAL TOLERANCE ±0.05

SYSTEM IMPEDANCE	DIM R (GOLD FINGER LENGTH)
85 ohm	2.50

PIN COUNT N (SIGNAL)	DIMENSION				
	AA	BB	CC	DD	EE
60	10.50	36.50	32.50	30.40	10.35
80	18.50	44.50	40.50	38.40	18.35
100	26.50	52.50	48.50	46.40	26.35
120	34.50	60.50	56.50	54.40	34.35
140	42.50	68.50	64.50	62.40	42.35
160	50.50	76.50	72.50	70.40	50.35
180	58.50	84.50	80.50	78.40	58.35
200	66.50	92.50	88.50	86.40	66.35



UNLESS OTHERWISE SPECIFIED TOLERANCES	
U.S.	METRIC
.X +/-	0.3
.XX +/-	0.20
.XXX +/-	0.15
FRACTIONS +/-	
ANGLES +/-	5°
FOR MATERIALS AND FINISHES SEE NOTES	
REMOVE SHARP EDGES	
DIMENSIONS	
—U.S.—	INCHES
(METRIC)	(mm)

APPROVAL	DATE
DRAWN	Apr.25,2018
CHECKED	
APPROVED	
DRAWING FILE :	
INTERNAL\DRAWING\CE\C CEXXXXXX011011X	
ANGLE OF PROJECTION	

Amphenol		
TITLE		
COOL EDGE CONNECTOR 0.80MM PITCH		
SIZE	DRAWING NO.	REV.
A3	C CEXXXXXX011011X	7
SCALE	NONE	SHEET 3 OF 8

This document is the property of Amphenol Corporation and is delivered on the express condition that it is not to be disclosed, reproduced or used, in whole or in part, for manufacture or sale by anyone other than Amphenol Corporation without its prior consent, & that no right is granted to disclose or to use any information in this document.

CUSTOMER DRAWING

REVISIONS				
SYM	ECN	DESCRIPTION	DATE	APPROVED
1	N/A	PRELIMINARY PROPOSAL	Mar.08,2017	

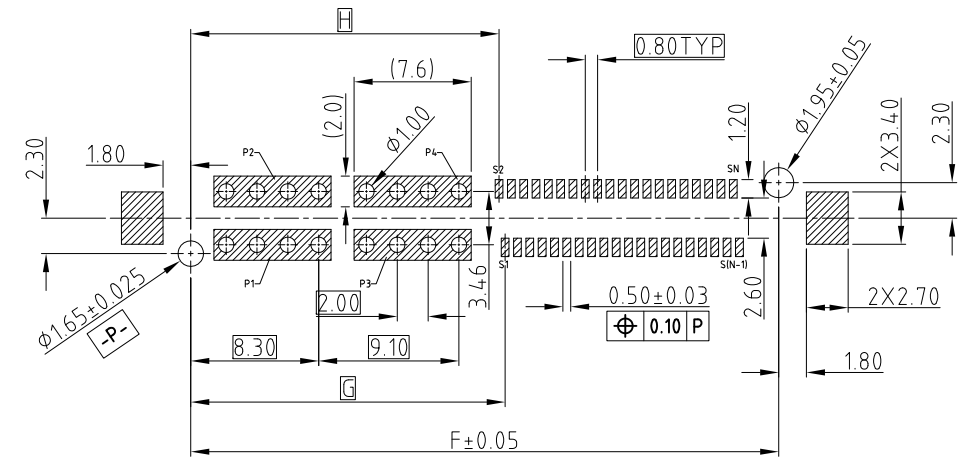
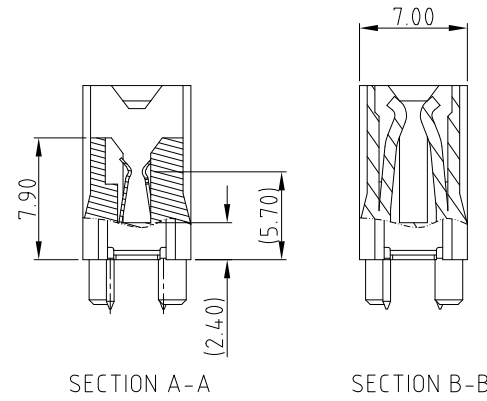
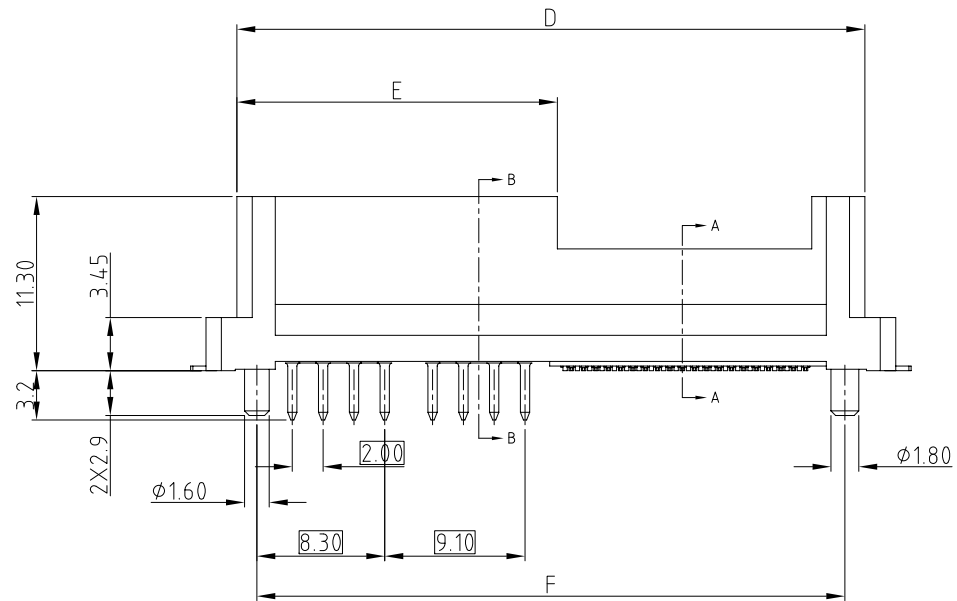
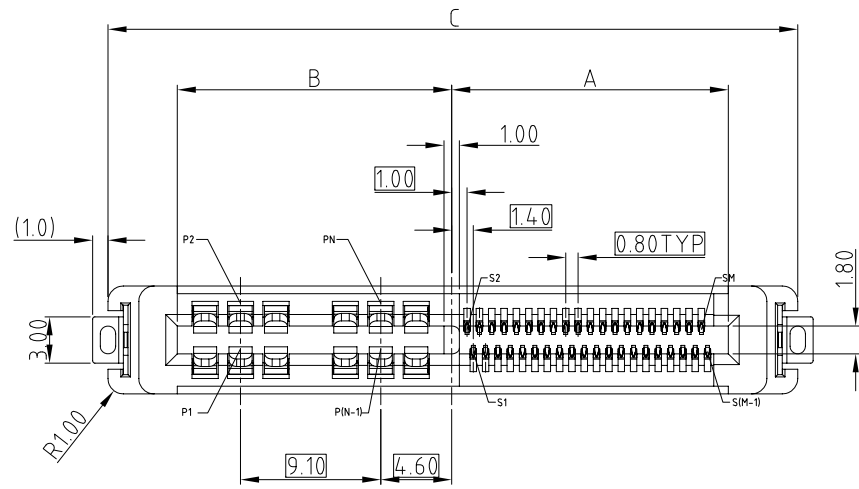

RECOMMEND SOLDER PCB LAYOUT
GENERAL TOLERANCE ±0.05MM

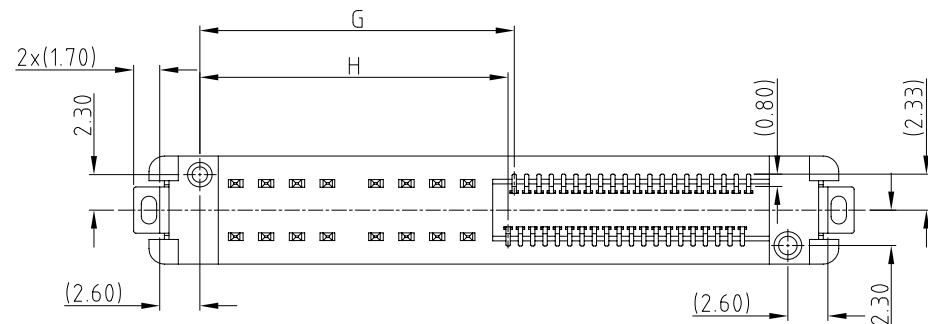

UNLESS OTHERWISE SPECIFIED TOLERANCES	
U.S.	METRIC
.X +/-	0.25
.XX +/-	0.20
.XXX +/-	0.15
FRACTIONS +/-	
ANGLES +/-	5°

APPROVAL	DATE
DRAWN	Apr.25,2018
CHECKED	
APPROVED	
DRAWING FILE :	
INTERNAL\DRAWING\CE\C CEXXXXXX011011X	
ANGLE OF PROJECTION	

Amphenol		
TITLE HYBRID COOL EDGE CONNECTOR 0.80MM PITCH		
SIZE	DRAWING NO.	REV.
A3	C CEXXXXXX011011X	7
SCALE	NONE	SHEET 4 OF 8

This document is the property of Amphenol Corporation and is delivered on the express condition that it is not to be disclosed, reproduced or used, in whole or in part, for manufacture or sale by anyone other than Amphenol Corporation without its prior consent, & that no right is granted to disclose or to use any information in this document.

CUSTOMER DRAWING

REVISIONS				
SYM	ECN	DESCRIPTION	DATE	APPROVED
		SEE SHEET 1		

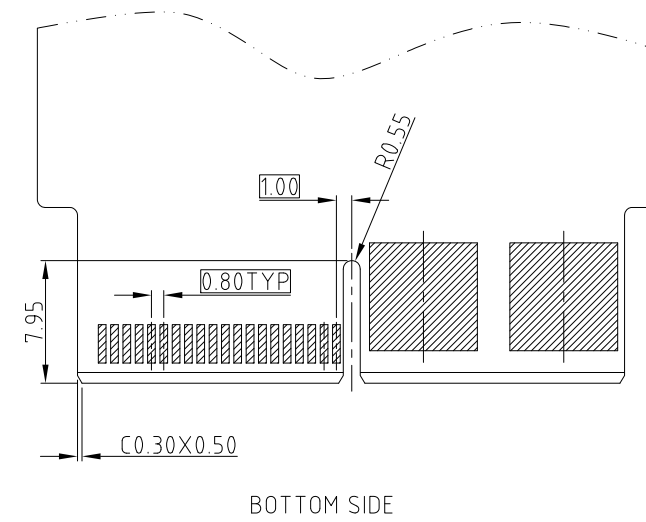
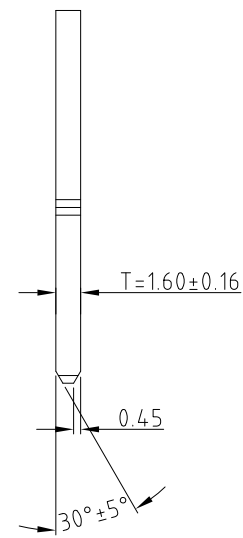
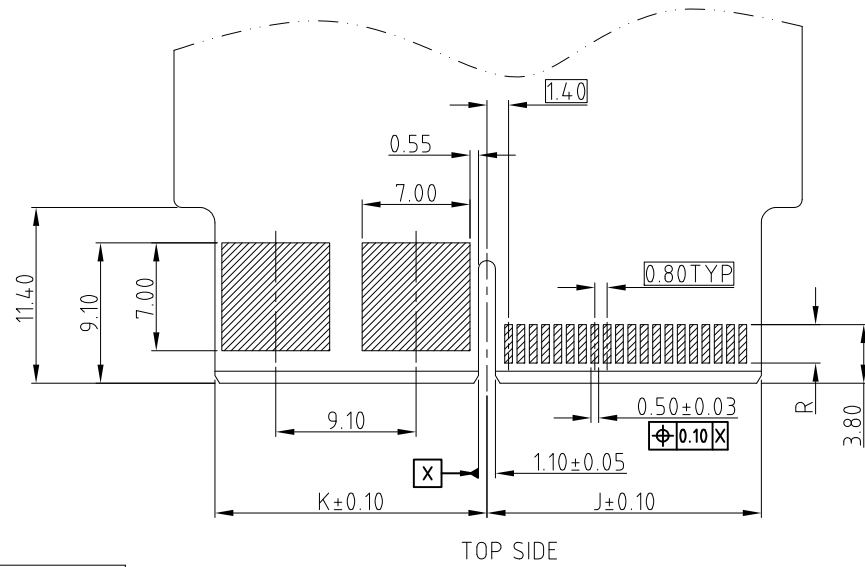

SYSTEM IMPEDANCE	DIM R (GOLD FINGER LENGTH)
85 ohm	2.50

RECOMMEND MATING CARD, THICKNESS=1.60±0.16MM
GENERAL TOLERANCE ±0.05MM

PIN COUNT		DIMENSION									
N (POWER)	M (SIGNAL)	A	B	C	D	E	F	G	H	J	K
2	18	9.15	8.70	26.85	22.85	11.70	20.25	11.30	10.90	9.00	8.55
	20	9.95	8.70	27.65	23.65	11.70	21.05	11.30	10.90	9.80	8.55
	40	17.95	8.70	35.65	31.65	11.70	29.05	11.30	10.90	17.80	8.55
	60	25.95	8.70	43.65	39.65	11.70	37.05	11.30	10.90	25.80	8.55
	80	33.95	8.70	51.65	47.65	11.70	45.05	11.30	10.90	33.80	8.55
	100	41.95	8.70	59.65	55.65	11.70	53.05	11.30	10.90	41.80	8.55
	120	49.95	8.70	67.65	63.65	11.70	61.05	11.30	10.90	49.80	8.55
	140	57.95	8.70	75.65	71.65	11.70	69.05	11.30	10.90	57.80	8.55
	160	65.95	8.70	83.65	79.65	11.70	77.05	11.30	10.90	65.80	8.55
	180	73.95	8.70	91.65	87.65	11.70	85.05	11.30	10.90	73.80	8.55
200	81.95	8.70	99.65	95.65	11.70	93.05	11.30	10.90	81.80	8.55	

PIN COUNT		DIMENSION									
N (POWER)	M (SIGNAL)	A	B	C	D	E	F	G	H	J	K
4	20	9.95	17.80	36.75	32.75	20.80	30.15	20.40	20.00	9.80	17.65
	40	17.95	17.80	44.75	40.75	20.80	38.15	20.40	20.00	17.80	17.65
	60	25.95	17.80	52.75	48.75	20.80	46.15	20.40	20.00	25.80	17.65
	80	33.95	17.80	60.75	56.75	20.80	54.15	20.40	20.00	33.80	17.65
	100	41.95	17.80	68.75	64.75	20.80	62.15	20.40	20.00	41.80	17.65
	120	49.95	17.80	76.75	72.75	20.80	70.15	20.40	20.00	49.80	17.65
	140	57.95	17.80	84.75	80.75	20.80	78.15	20.40	20.00	57.80	17.65
	160	65.95	17.80	92.75	88.75	20.80	86.15	20.40	20.00	65.80	17.65
	180	73.95	17.80	100.75	96.75	20.80	94.15	20.40	20.00	73.80	17.65
	200	81.95	17.80	108.75	104.75	20.80	102.15	20.40	20.00	81.80	17.65

PIN COUNT		DIMENSION									
N (POWER)	M (SIGNAL)	A	B	C	D	E	F	G	H	J	K
6	20	9.95	26.90	45.85	41.85	29.90	39.25	29.50	29.10	9.80	26.75
	40	17.95	26.90	53.85	49.85	29.90	47.25	29.50	29.10	17.80	26.75
	60	25.95	26.90	61.85	57.85	29.90	55.25	29.50	29.10	25.80	26.75
	80	33.95	26.90	69.85	65.85	29.90	63.25	29.50	29.10	33.80	26.75
	100	41.95	26.90	77.85	73.85	29.90	71.25	29.50	29.10	41.80	26.75
	120	49.95	26.90	85.85	81.85	29.90	79.25	29.50	29.10	49.80	26.75
	140	57.95	26.90	93.85	89.85	29.90	87.25	29.50	29.10	57.80	26.75
	160	65.95	26.90	101.85	97.85	29.90	95.25	29.50	29.10	65.80	26.75
	170	69.95	26.90	105.85	101.85	29.90	99.25	29.50	29.10	69.80	26.75



UNLESS OTHERWISE SPECIFIED TOLERANCES		APPROVAL	DATE	<h1>Amphenol</h1>
U.S. METRIC		DRAWN	Apr.25,2018	
.X +/- 0.25 .XX +/- 0.20 .XXX +/- 0.15 FRACTIONS +/- ANGLES +/- 5°		CHECKED		
FOR MATERIALS AND FINISHES SEE NOTES		APPROVED		TITLE
REMOVE SHARP EDGES	DIMENSIONS	DRAWING FILE : INTERNAL\DRAWING\CE\CE CEXXXXXX011011X		HYBRID COOL EDGE CONNECTOR 0.80MM PITCH
—U.S.— INCHES	(METRIC) (mm)	ANGLE OF PROJECTION		SIZE DRAWING NO. REV.
				A3 C CEXXXXXX011011X 7
				SCALE NONE SHEET 5 OF 8

This document is the property of Amphenol Corporation and is delivered on the express condition that it is not to be disclosed, reproduced or used, in whole or in part, for manufacture or sale by anyone other than Amphenol Corporation without its prior consent, & that no right is granted to disclose or to use any information in this document.

CUSTOMER DRAWING

REVISIONS				
SYM	ECN	DESCRIPTION	DATE	APPROVED
		SEE SHEET 1		

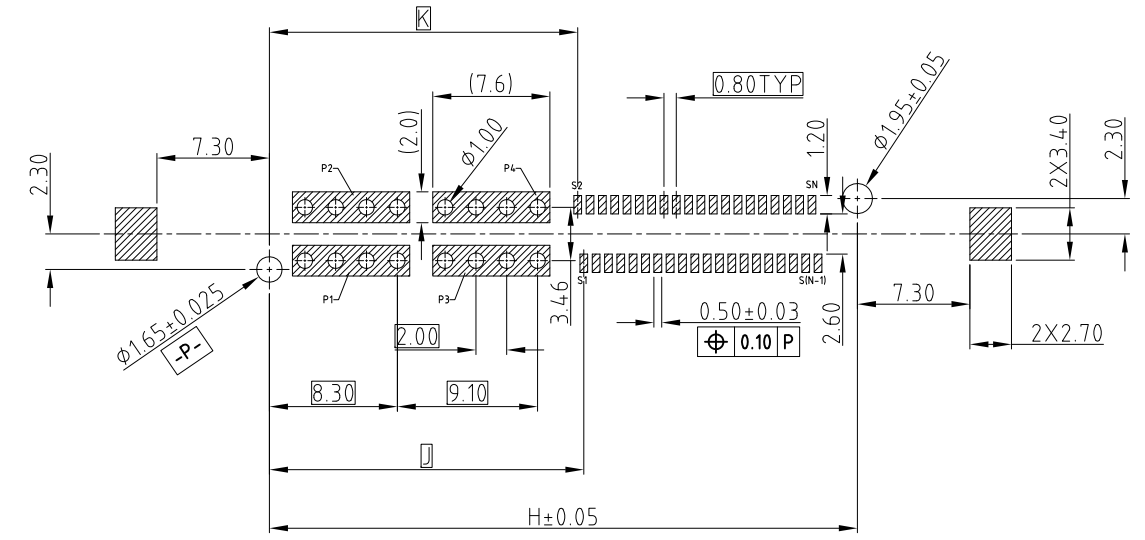

RECOMMEND SOLDER PCB LAYOUT
GENERAL TOLERANCE ±0.05MM

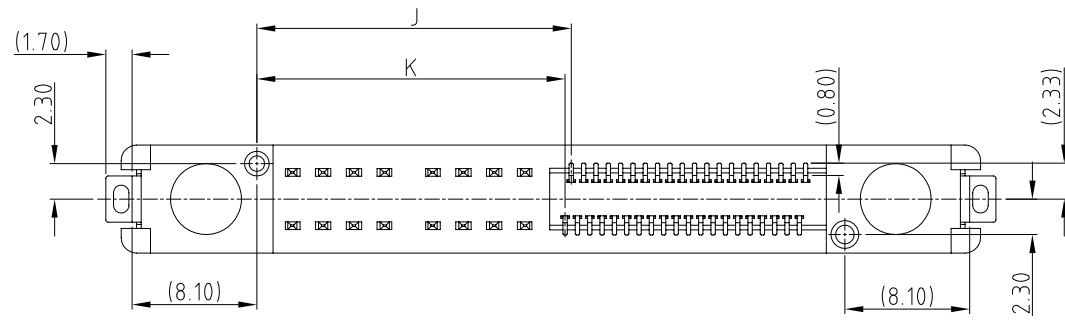
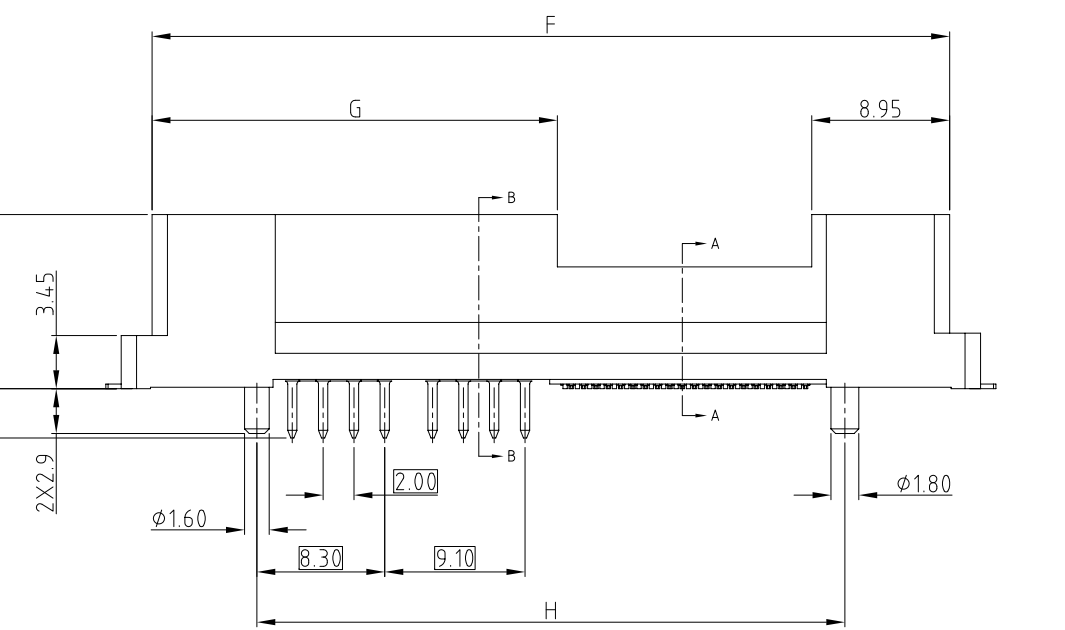
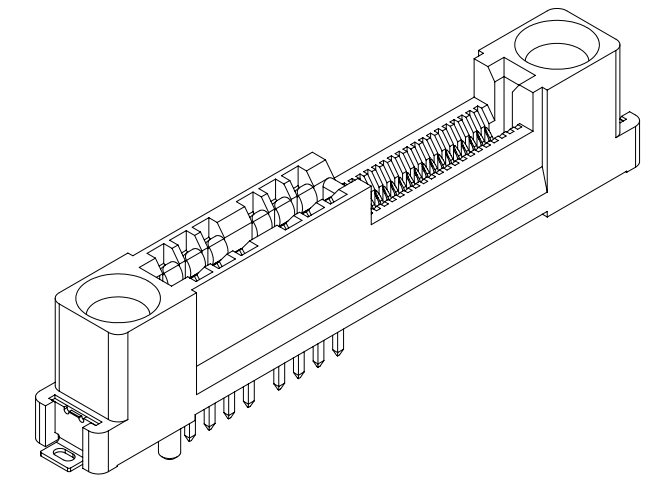
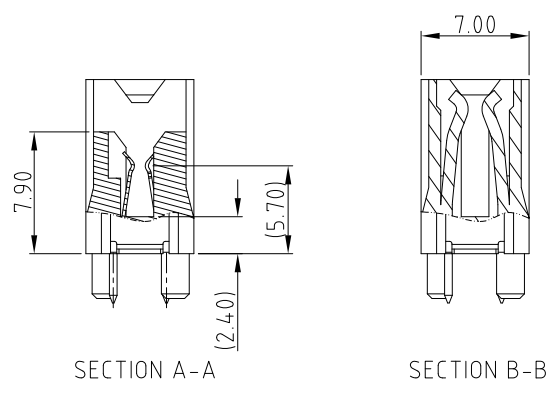

UNLESS OTHERWISE SPECIFIED TOLERANCES	
U.S.	METRIC
.X +/-	0.25
.XX +/-	0.20
.XXX +/-	0.15
FRACTIONS +/-	5°
ANGLES +/-	

APPROVAL	DATE
DRAWN	Apr.25,2018
CHECKED	
APPROVED	
DRAWING FILE :	
INTERNAL\DRAWING\CE\C CEXXXXXX011011X	
ANGLE OF PROJECTION	

Amphenol		
TITLE HYBRID COOL EDGE CONNECTOR 0.80MM PITCH		
SIZE	DRAWING NO.	REV.
A3	C CEXXXXXX011011X	7
SCALE	NONE	SHEET 6 OF 8

This document is the property of Amphenol Corporation and is delivered on the express condition that it is not to be disclosed, reproduced or used, in whole or in part, for manufacture or sale by anyone other than Amphenol Corporation without its prior consent, & that no right is granted to disclose or to use any information in this document.

CUSTOMER DRAWING

REVISIONS				
SYM	ECN	DESCRIPTION	DATE	APPROVED
		SEE SHEET 1		

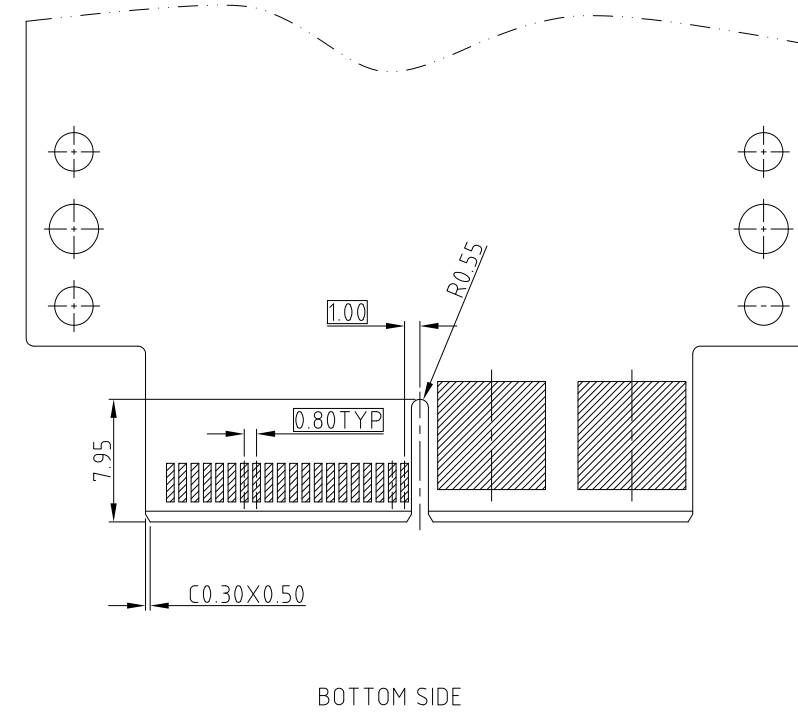
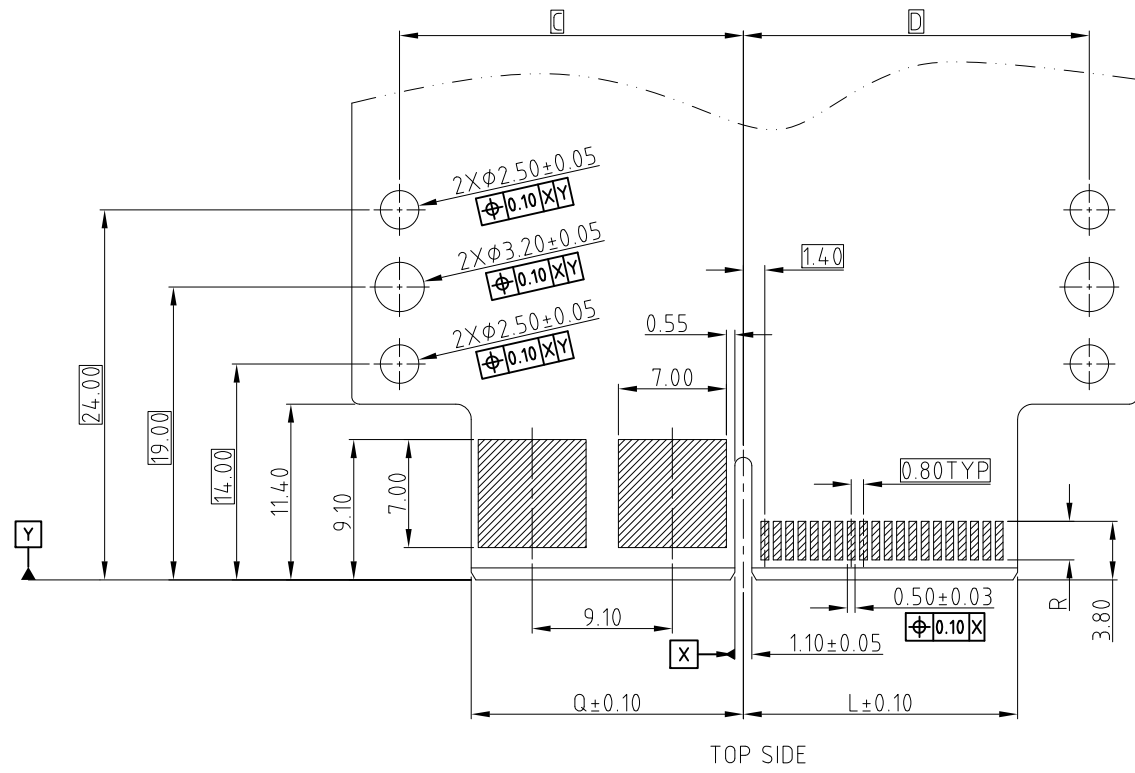

RECOMMEND MATING CARD, THICKNESS=1.60±0.16MM
GENERAL TOLERANCE ±0.05MM

SYSTEM IMPEDANCE	DIM R (GOLD FINGER LENGTH)
85 ohm	2.50



UNLESS OTHERWISE SPECIFIED TOLERANCES		APPROVAL	DATE	Amphenol
	U.S. METRIC	DRAWN	Apr.25,2018	
.X +/-	0.25	CHECKED		
.XX +/-	0.20	APPROVED		TITLE
.XXX +/-	0.15			HYBRID COOL EDGE CONNECTOR 0.80MM PITCH
FRACTIONS +/-	5°	DRAWING FILE :	INTERNAL\DRAWING\CE\CE CEXXXXXX011011X	SIZE
ANGLES +/-		ANGLE OF PROJECTION		DRAWING NO.
FOR MATERIALS AND FINISHES SEE NOTES				C CEXXXXXX011011X
REMOVE SHARP EDGES				REV.
DIMENSIONS				7
-U.S.-	INCHES			SCALE
(METRIC)	(mm)			NONE
				SHEET 7 OF 8

This document is the property of Amphenol Corporation and is delivered on the express condition that it is not to be disclosed, reproduced or used, in whole or in part, for manufacture or sale by anyone other than Amphenol Corporation without its prior consent, & that no right is granted to disclose or to use any information in this document.

CUSTOMER DRAWING

REVISIONS				
SYM	ECN	DESCRIPTION	DATE	APPROVED
		SEE SHEET 1		

PIN COUNT		DIMENSION											
N (POWER)	M (SIGNAL)	A	B	C	D	E	F	G	H	J	K	L	Q
2	18	9.15	8.70	13.20	13.65	37.85	33.85	17.20	20.25	11.30	10.90	9.00	8.55
	20	9.95	8.70	13.20	14.45	38.65	34.65	17.20	21.05	11.30	10.90	9.80	8.55
	40	17.95	8.70	13.20	22.45	46.65	42.65	17.20	29.05	11.30	10.90	17.80	8.55
	60	25.95	8.70	13.20	30.45	54.65	50.65	17.20	37.05	11.30	10.90	25.80	8.55
	80	33.95	8.70	13.20	38.45	62.65	58.65	17.20	45.05	11.30	10.90	33.80	8.55
	100	41.95	8.70	13.20	46.45	70.65	66.65	17.20	53.05	11.30	10.90	41.80	8.55
	120	49.95	8.70	13.20	54.45	78.65	74.65	17.20	61.05	11.30	10.90	49.80	8.55
	140	57.95	8.70	13.20	62.45	86.65	82.65	17.20	69.05	11.30	10.90	57.80	8.55
	160	65.95	8.70	13.20	70.45	94.65	90.65	17.20	77.05	11.30	10.90	65.80	8.55
	180	73.95	8.70	13.20	78.45	102.65	98.65	17.20	85.05	11.30	10.90	73.80	8.55
	200	81.95	8.70	13.20	86.45	110.65	106.65	17.20	93.05	11.30	10.90	81.80	8.55

PIN COUNT		DIMENSION											
N (POWER)	M (SIGNAL)	A	B	C	D	E	F	G	H	J	K	L	Q
4	20	9.95	17.80	22.30	14.45	47.75	43.75	26.30	30.15	20.40	20.00	9.80	17.65
	40	17.95	17.80	22.30	22.45	55.75	51.75	26.30	38.15	20.40	20.00	17.80	17.65
	60	25.95	17.80	22.30	30.45	63.75	59.75	26.30	46.15	20.40	20.00	25.80	17.65
	80	33.95	17.80	22.30	38.45	71.75	67.75	26.30	54.15	20.40	20.00	33.80	17.65
	100	41.95	17.80	22.30	46.45	79.75	75.75	26.30	62.15	20.40	20.00	41.80	17.65
	120	49.95	17.80	22.30	54.45	87.75	83.75	26.30	70.15	20.40	20.00	49.80	17.65
	140	57.95	17.80	22.30	62.45	95.75	91.75	26.30	78.15	20.40	20.00	57.80	17.65
	160	65.95	17.80	22.30	70.45	103.75	99.75	26.30	86.15	20.40	20.00	65.80	17.65
	180	73.95	17.80	22.30	78.45	111.75	107.75	26.30	94.15	20.40	20.00	73.80	17.65
	200	81.95	17.80	22.30	86.45	119.75	115.75	26.30	102.15	20.40	20.00	81.80	17.65

PIN COUNT		DIMENSION											
N (POWER)	M (SIGNAL)	A	B	C	D	E	F	G	H	J	K	L	Q
6	20	9.95	26.90	31.40	14.45	56.85	52.85	35.40	39.25	29.50	29.10	9.80	26.75
	40	17.95	26.90	31.40	22.45	64.85	60.85	35.40	47.25	29.50	29.10	17.80	26.75
	60	25.95	26.90	31.40	30.45	72.85	68.85	35.40	55.25	29.50	29.10	25.80	26.75
	80	33.95	26.90	31.40	38.45	80.85	76.85	35.40	63.25	29.50	29.10	33.80	26.75
	100	41.95	26.90	31.40	46.45	88.85	84.85	35.40	71.25	29.50	29.10	41.80	26.75
	120	49.95	26.90	31.40	54.45	96.85	92.85	35.40	79.25	29.50	29.10	49.80	26.75
	140	57.95	26.90	31.40	62.45	104.85	100.85	35.40	87.25	29.50	29.10	57.80	26.75
	160	65.95	26.90	31.40	70.45	112.85	108.85	35.40	95.25	29.50	29.10	65.80	26.75
	170	69.95	26.90	31.40	74.45	120.85	112.85	35.40	99.25	29.50	29.10	69.80	26.75



UNLESS OTHERWISE SPECIFIED TOLERANCES U.S. METRIC .X +/- 0.25 .XX +/- 0.20 .XXX +/- 0.15 FRACTIONS +/- ANGLES +/- 5° FOR MATERIALS AND FINISHES SEE NOTES REMOVE SHARP EDGES DIMENSIONS —U.S.— INCHES (METRIC) (mm)	APPROVAL DRAWN CHECKED APPROVED	DATE Apr.25,2018	Amphenol TITLE HYBRID COOL EDGE CONNECTOR 0.80MM PITCH SIZE DRAWING NO. REV. A3 C CEXXXXXX011011X 7 SCALE NONE SHEET 8 OF 8
	DRAWING FILE :		
	INTERNAL\DRAWING\CE\C CEXXXXXX011011X		
	ANGLE OF PROJECTION		

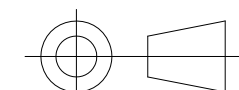

Компания «Океан Электроники» предлагает заключение долгосрочных отношений при поставках импортных электронных компонентов на взаимовыгодных условиях!

Наши преимущества:

- Поставка оригинальных импортных электронных компонентов напрямую с производств Америки, Европы и Азии, а так же с крупнейших складов мира;
- Широкая линейка поставок активных и пассивных импортных электронных компонентов (более 30 млн. наименований);
- Поставка сложных, дефицитных, либо снятых с производства позиций;
- Оперативные сроки поставки под заказ (от 5 рабочих дней);
- Экспресс доставка в любую точку России;
- Помощь Конструкторского Отдела и консультации квалифицированных инженеров;
- Техническая поддержка проекта, помощь в подборе аналогов, поставка прототипов;
- Поставка электронных компонентов под контролем ВП;
- Система менеджмента качества сертифицирована по Международному стандарту ISO 9001;
- При необходимости вся продукция военного и аэрокосмического назначения проходит испытания и сертификацию в лаборатории (по согласованию с заказчиком);
- Поставка специализированных компонентов военного и аэрокосмического уровня качества (Xilinx, Altera, Analog Devices, Intersil, Interpoint, Microsemi, Actel, Aeroflex, Peregrine, VPT, Syfer, Eurofarad, Texas Instruments, MS Kennedy, Miteq, Cobham, E2V, MA-COM, Hittite, Mini-Circuits, General Dynamics и др.);

Компания «Океан Электроники» является официальным дистрибьютором и эксклюзивным представителем в России одного из крупнейших производителей разъемов военного и аэрокосмического назначения «JONHON», а так же официальным дистрибьютором и эксклюзивным представителем в России производителя высокотехнологичных и надежных решений для передачи СВЧ сигналов «FORSTAR».



JONHON

«JONHON» (основан в 1970 г.)

Разъемы специального, военного и аэрокосмического назначения:

(Применяются в военной, авиационной, аэрокосмической, морской, железнодорожной, горно- и нефтедобывающей отраслях промышленности)

«FORSTAR» (основан в 1998 г.)

ВЧ соединители, коаксиальные кабели, кабельные сборки и микроволновые компоненты:

(Применяются в телекоммуникациях гражданского и специального назначения, в средствах связи, РЛС, а так же военной, авиационной и аэрокосмической отраслях промышленности).



Телефон: 8 (812) 309-75-97 (многоканальный)

Факс: 8 (812) 320-03-32

Электронная почта: ocean@oceanchips.ru

Web: <http://oceanchips.ru/>

Адрес: 198099, г. Санкт-Петербург, ул. Калинина, д. 2, корп. 4, лит. А