

## Description

The 5PB11xx is a high-performance LVCMOS clock buffer family of devices. It has an additive phase jitter of 50fs RMS.

There are five different fan-out variations available: 1:2 to 1:10.

The 5PB11xx supports a synchronous glitch-free output enable (OE) function to eliminate any potential intermediate incorrect output clock cycles when enabling or disabling outputs. It can operate from a 1.8V to 3.3V supply.

The 5PB1104 is also available in an Automotive Grade 1, AEC-Q100 qualified version.

## Typical Applications

- Industrial applications
- Automotive applications

## Features

- High-performance 1:2, 1:4, 1:6, 1:8, 1:10 LVCMOS clock buffer
- Very low pin-to-pin skew: < 50ps
- Very low additive jitter: < 50fs
- Supply voltage: 1.8V to 3.3V
- 3.3V tolerant input clock
- $f_{MAX} = 200\text{MHz}$
- Integrated serial termination for 50Ω channel
- Packaged in 8-, 14-, 16-, 20-pin TSSOP and as small as 2 × 2 mm DFN and VFQFPN packages
- Industrial (-40°C to +85°C) and extended (-40°C to +105°C) temperature ranges
- 5PB1104 available in AEC-Q100 qualified, Automotive Grade 1 (-40°C to +125°C)

## Block Diagram

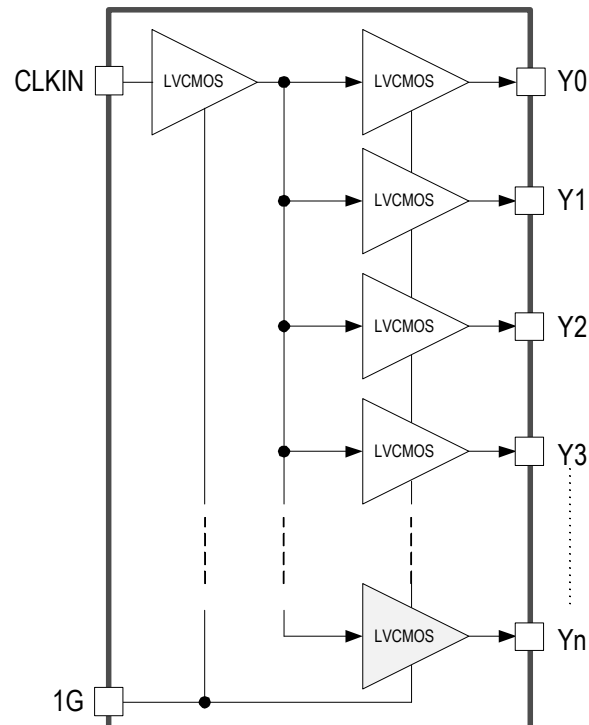

# Contents

Description .....	1
Typical Applications .....	1
Features .....	1
Block Diagram .....	1
Pin Assignments–TSSOP Packages .....	3
Pin Descriptions–TSSOP Packages .....	3
Pin Assignments–DFN/VFQFPN Packages .....	4
Pin Descriptions–DFN/VFQFPN Packages .....	4
Output Logic Table .....	5
Absolute Maximum Ratings .....	5
Recommended Operating Conditions .....	5
Thermal Characteristics .....	6
DC Electrical Characteristics .....	7
AC Electrical Characteristics .....	10
Phase Noise Plots .....	13
Test Load and Circuit .....	14
Package Outline Drawings .....	14
Marking Diagrams (Industrial) .....	15
Marking Diagrams (Extended) .....	16
Marking Diagrams (Automotive) .....	16
Ordering Information (Industrial) .....	17
Ordering Information (Extended) .....	18
Ordering Information (Automotive) .....	18
Revision History .....	19



## Pin Assignments–DFN/VFQFPN Packages

Figure 2. Pin Assignments for DFN/QFN Packages

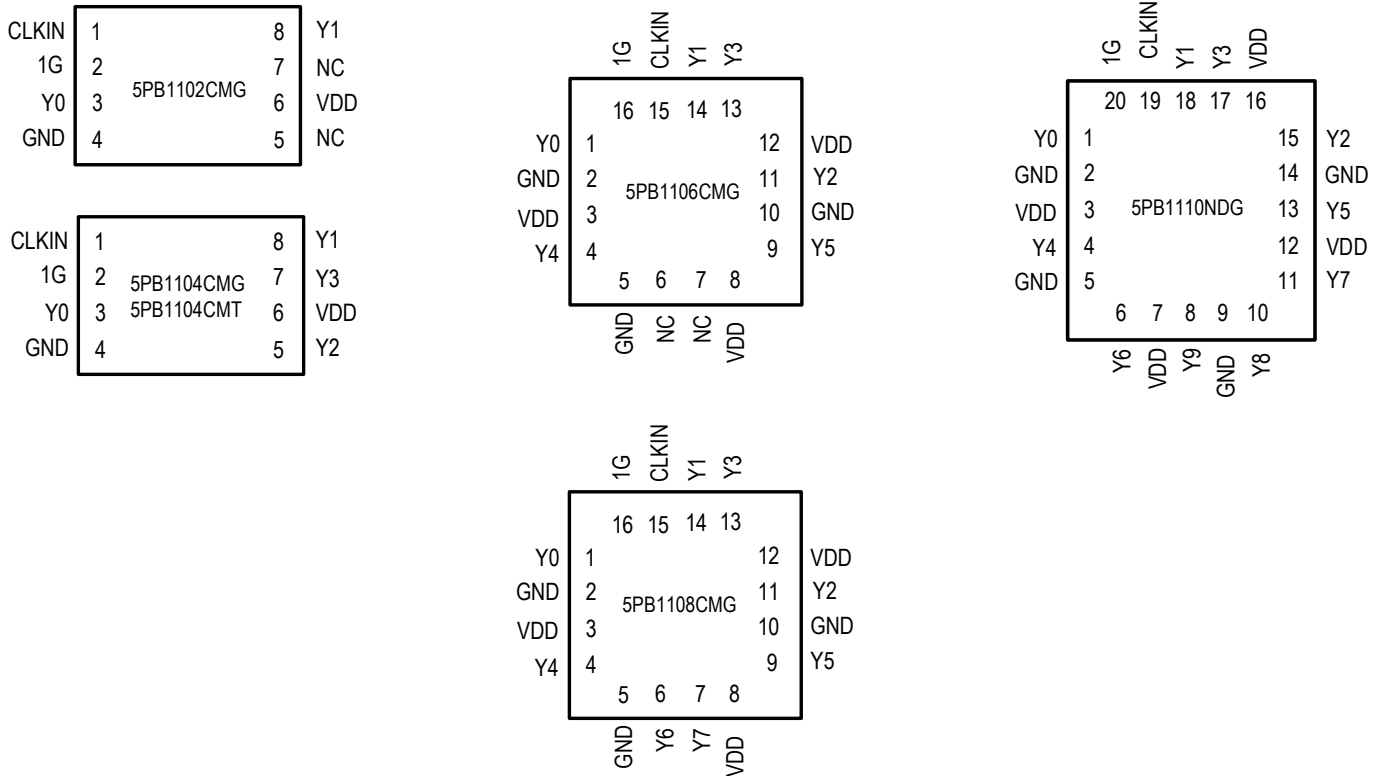

## Pin Descriptions–DFN/VFQFPN Packages

Table 2. Pin Descriptions for DFN/VFQFPN Packages

Device Number	LVC MOS Clock Input	Clock Output Enable	LVC MOS Clock Output	Supply Voltage	Ground
	CLKIN	1G	Y0, Y1, . . . Y9	V <sub>DD</sub>	GND
5PB1102CMG	1	2	3, 8	6	4
5PB1104CMG 5PB1104CMT	1	2	3, 5, 7, 8	6	4
5PB1106CMG	15	16	1, 4, 9, 11, 13, 14	3, 8, 12	2, 5, 10
5PB1108CMG	15	16	1, 4, 6, 7, 9, 11, 13, 14	3, 8, 12	2, 5, 10
5PB1110NDG	19	20	1, 4, 6, 8, 10, 11, 13, 15, 17, 18	3, 7, 12, 16	2, 5, 9, 14

## Output Logic Table

Inputs		Output
CLKIN	1G	Yn
X	L	L
L	H	L
H	H	H

After at least three cycles of input clock toggling. Output Enable function is asynchronous to eliminate any intermediate incorrect output clock cycles during transition which may cause frequency peaking to the downstream device.

## Absolute Maximum Ratings

The absolute maximum ratings are stress ratings only. Stresses greater than those listed below can cause permanent damage to the device. Functional operation of the 5PB11xx at absolute maximum ratings is not implied. Exposure to absolute maximum rating conditions may affect device reliability.

Table 3. Absolute Maximum Ratings

Item	Rating
Supply Voltage, $V_{DD}$	3.8V
Output Enable and All Outputs	-0.4 V to $V_{DD} + 0.5$ V
Input Voltage, CLKIN	-0.4 V to 3.465V
Ambient Operating Temperature (Industrial)	-40 to +85°C
Ambient Operating Temperature (Extended)	-40 to +105°C
Ambient Operating Temperature (Automotive Grade 1)	-40 to +125°C
Storage Temperature	-65 to +150°C
Junction Temperature	125°C
Soldering Temperature	260°C

## Recommended Operating Conditions

Table 4. Recommended Operating Conditions

Parameter	Minimum	Typical	Maximum	Units
Ambient Operating Temperature (Industrial)	-40		+85	
Ambient Operating Temperature (Extended)	-40		+105	
Ambient Operating Temperature (Automotive Grade 1)	-40		+125	°C
Power Supply Voltage (measured in respect to GND)	+1.71		+3.465	V

## Thermal Characteristics

Table 5. Thermal Characteristics

Package	Applies to	$\Theta_{JA}$	$\Theta_{JC}$	$\Theta_{JB}$	Units
8-TSSOP	5PB1102PGG, 5PB1104PGG	122.0	58.2	139.3	°C/W; still air
14-TSSOP	5PB1106PGG	84.5	44.2	64.5	°C/W; still air
16-TSSOP	5PB1108PGG	80.9	43.3	60.1	°C/W; still air
20-TSSOP	5PB1110PGG	72.5	37.9	49.8	°C/W; still air
8-DFN	5PB1102CMG, 5PB1104CMG 5PB1104CMT	120.2	99.4	63.3	°C/W; still air
16-VFQFPN	5PB1106CMG, 5PB1108CMG	115.6	83.1	61.8	°C/W; still air
20-VFQFPN	5PB1110NDG	49.6	94.7	5.1	°C/W; still air

## DC Electrical Characteristics

$V_{DD} = 1.8V, 2.5V, \text{ or } 3.3V$  (see tables below)

Table 6. DC Electrical Characteristics –  $V_{DD} = 1.8V \pm 5\%$

Symbol	Parameter	Applies to	Conditions	Minimum	Typical	Maximum	Units
$V_{DD}$	Operating Voltage	All devices		1.71	1.8	1.89	V
$V_{IH}$	Input High Voltage, CLKIN <sup>[1]</sup>	All devices		$0.7 \times V_{DD}$			V
$V_{IL}$	Input Low Voltage, CLKIN <sup>[1]</sup>	All devices				$0.3 \times V_{DD}$	V
$V_{IH}$	Input High Voltage, 1G	All devices		1.6		$V_{DD}$	V
$V_{IL}$	Input Low Voltage, 1G	All devices				0.6	V
$V_{OH}$	Output High Voltage	Industrial and Extended <sup>[2]</sup>	$I_{OH} = -5mA.$	1.4			V
	Output High Voltage	Automotive <sup>[3]</sup>	$I_{OH} = -5mA.$	1.2			V
$V_{OL}$	Output Low Voltage	Industrial and Extended <sup>[2]</sup>	$I_{OL} = 5mA.$			0.4	V
	Output Low Voltage	Automotive <sup>[3]</sup>	$I_{OL} = 5mA.$			0.45	V
$Z_O$	Nominal Output Impedance	All devices			50		$\Omega$
$C_{IN}$	Input Capacitance	All devices	CLKIN, 1G pin.		5		pF
$I_{DD}$	Operating Supply Current, 5PB1102	Industrial and Extended <sup>[2]</sup>	100MHz, no load, 25°C.		6	8	mA
	Operating Supply Current, 5PB1104				12	13	
	Operating Supply Current, 5PB1106				15	18	
	Operating Supply Current, 5PB1108				20	23	
	Operating Supply Current, 5PB1110				23	27	
$I_{DD}$	Operating Supply Current	Automotive <sup>[3]</sup>	0.001MHz, $C_L = 5pF.$		0.7	1	mA
			0.008MHz, $C_L = 5pF.$		0.7	1	
			40MHz, $C_L = 5pF.$		11	13	
			100MHz, $C_L = 5pF.$		25	30	
			156.25MHz, $C_L = 5pF.$		37	47	
			200MHz, $C_L = 5pF.$		39	57	

<sup>[1]</sup> Nominal switching threshold is  $V_{DD}/2$ .

<sup>[2]</sup> 5PB11xxPGGI, 5PB11xxPGGK, 5PB11xxCMGI, 5PB11xxCMGK.  $T_A = -40^\circ C$  to  $+105^\circ C$  unless stated otherwise.

<sup>[3]</sup> 5PB1104CMG1 and 5PB1104CMT1 only.  $T_A = -40^\circ C$  to  $+125^\circ C$  unless stated otherwise.

Table 7. DC Electrical Characteristics –  $V_{DD} = 2.5V \pm 5\%$ 

Symbol	Parameter	Applies to	Conditions	Minimum	Typical	Maximum	Units
$V_{DD}$	Operating Voltage	All devices		2.375	2.5	2.625	V
$V_{IH}$	Input High Voltage, CLKIN <sup>[1]</sup>	All devices		$0.7 \times V_{DD}$			V
$V_{IL}$	Input Low Voltage, CLKIN <sup>[1]</sup>	All devices				$0.3 \times V_{DD}$	V
$V_{IH}$	Input High Voltage, 1G	All devices		1.8		$V_{DD}$	V
$V_{IL}$	Input Low Voltage, 1G	All devices				0.7	V
$V_{OH}$	Output High Voltage	Industrial and Extended <sup>[2]</sup>	$I_{OH} = -8mA$ .	1.9			V
	Output High Voltage	Automotive <sup>[3]</sup>	$I_{OH} = -8mA$ .	1.6			V
$V_{OL}$	Output Low Voltage	Industrial and Extended <sup>[2]</sup>	$I_{OL} = 8mA$ .			0.5	V
	Output Low Voltage	Automotive <sup>[3]</sup>	$I_{OL} = 8mA$ .			0.625	V
$Z_O$	Nominal Output Impedance	All devices			50		$\Omega$
$C_{IN}$	Input Capacitance	All devices	CLKIN, 1G pin.		5		pF
$I_{DD}$	Operating Supply Current, 5PB1102	Industrial and Extended <sup>[2]</sup>	100MHz, no load, 25°C.		9	11	mA
	Operating Supply Current, 5PB1104				15	18	
	Operating Supply Current, 5PB1106				21	24	
	Operating Supply Current, 5PB1108				27	31	
	Operating Supply Current, 5PB1110				32	37	
$I_{DD}$	Operating Supply Current	Automotive <sup>[3]</sup>	0.001MHz, $C_L = 5pF$ .		0.9	1.3	mA
			0.008MHz, $C_L = 5pF$ .		0.9	1.3	
			40MHz, $C_L = 5pF$ .		15	17	
			100MHz, $C_L = 5pF$ .		35	42	
			156.25MHz, $C_L = 5pF$ .		52	67	
			200MHz, $C_L = 5pF$ .		56	80	

<sup>[1]</sup> Nominal switching threshold is  $V_{DD}/2$ .

<sup>[2]</sup> 5PB11xxPGGI, 5PB11xxPGGK, 5PB11xxCMGI, 5PB11xxCMGK.  $T_A = -40^\circ C$  to  $+105^\circ C$  unless stated otherwise.

<sup>[3]</sup> 5PB1104CMG1 and 5PB1104CMT1 only.  $T_A = -40^\circ C$  to  $+125^\circ C$  unless stated otherwise.



Table 8. DC Electrical Characteristics –  $V_{DD} = 3.3V \pm 5\%$ 

Symbol	Parameter	Applies to	Conditions	Minimum	Typical	Maximum	Units
$V_{DD}$	Operating Voltage	All devices		3.135	3.3	3.465	V
$V_{IH}$	Input High Voltage, CLKIN <sup>[1]</sup>	All devices		$0.7 \times V_{DD}$			V
$V_{IL}$	Input Low Voltage, CLKIN <sup>[1]</sup>	All devices				$0.3 \times V_{DD}$	V
$V_{IH}$	Input High Voltage, 1G	Industrial and Extended <sup>[2]</sup>		2.0		$V_{DD}$	V
$V_{IH}$	Input High Voltage, 1G	Automotive <sup>[3]</sup>		2.1		$V_{DD}$	V
$V_{IL}$	Input Low Voltage, 1G	All devices				0.8	V
$V_{OH}$	Output High Voltage	Industrial and Extended <sup>[2]</sup>	$I_{OH} = -12mA$ .	2.4			V
	Output High Voltage	Automotive <sup>[3]</sup>	$I_{OH} = -12mA$ .	2.1			V
$V_{OL}$	Output Low Voltage	Industrial and Extended <sup>[2]</sup>	$I_{OL} = 12mA$ .			0.7	V
	Output Low Voltage	Automotive <sup>[3]</sup>	$I_{OL} = 12mA$ .			0.825	V
$Z_O$	Nominal Output Impedance	All devices			50		$\Omega$
$C_{IN}$	Input Capacitance	All devices	CLKIN, 1G pin.		5		pF
$I_{DD}$	Operating Supply Current, 5PB1102	Industrial and Extended <sup>[2]</sup>	100MHz, no load, 25°C.		12	13	mA
	Operating Supply Current, 5PB1104				20	22	
	Operating Supply Current, 5PB1106				25	30	
	Operating Supply Current, 5PB1108				35	38	
	Operating Supply Current, 5PB1110				40	45	
$I_{DD}$	Operating Supply Current	Automotive <sup>[3]</sup>	0.001MHz, $C_L = 5pF$ .		1.2	1.7	mA
			0.008MHz, $C_L = 5pF$ .		1.2	1.7	
			40MHz, $C_L = 5pF$ .		19	22	
			100MHz, $C_L = 5pF$ .		45	54	
			156.25MHz, $C_L = 5pF$ .		67	87	
			200MHz, $C_L = 5pF$ .		75	107	

<sup>[1]</sup> Nominal switching threshold is  $V_{DD}/2$ .

<sup>[2]</sup> 5PB11xxPGGI, 5PB11xxPGGK, 5PB11xxCMGI, 5PB11xxCMGK.  $T_A = -40^\circ C$  to  $+105^\circ C$  unless stated otherwise.

<sup>[3]</sup> 5PB1104CMG1 and 5PB1104CMT1 only.  $T_A = -40^\circ C$  to  $+125^\circ C$  unless stated otherwise.

## AC Electrical Characteristics

$V_{DD} = 1.8V, 2.5V, \text{ or } 3.3V$  (see tables below).

Table 9. AC Electrical Characteristics –  $V_{DD} = 1.8V \pm 5\%$

Symbol	Parameter	Applies to	Conditions	Minimum	Typical	Maximum	Units
	Input Frequency	All devices		0		200	MHz
$t_{OR}$	Output Rise Time (2pF load)	Industrial and Extended <sup>[1]</sup>	0.36V to 1.44V, $C_L = 2pF$ .		0.5	0.75	ns
$t_{OF}$	Output Fall Time (2pF load)	Industrial and Extended <sup>[1]</sup>	1.44V to 0.36V, $C_L = 2pF$ .		0.5	0.75	ns
$t_{OR}$	Output Rise Time (5pF load)	Industrial and Extended <sup>[1]</sup>	0.36V to 1.44V, $C_L = 5pF$ .		0.8	1.0	ns
$t_{OF}$	Output Fall Time (5pF load)	Industrial and Extended <sup>[1]</sup>	1.44V to 0.36V, $C_L = 5pF$ .		0.8	1.0	ns
$t_{OR}$	Output Rise Time (5pF load)	Automotive <sup>[2]</sup>	0.36V to 1.44V, $C_L = 5pF$ .		0.65	1.2	ns
$t_{OF}$	Output Fall Time (5pF load)	Automotive <sup>[2]</sup>	1.44V to 0.36V, $C_L = 5pF$ .		0.65	1.2	ns
$t_{START-UP}$	Start-up Time	All devices	Part start-up time for valid outputs after $V_{DD}$ ramp-up.			3	ms
$t_{PD}$	Propagation Delay <sup>[3]</sup>	Industrial and Extended <sup>[1]</sup>		1.5		2.5	ns
		Automotive <sup>[2]</sup>		1.0		3.4	ns
	Buffer Additive Phase Jitter, RMS	Industrial and Extended <sup>[1]</sup>	156.25MHz, Integration Range: 12kHz–20MHz.			0.05	ps
		Automotive <sup>[2]</sup>	156.25MHz, Integration Range: 12kHz–20MHz.			0.06	ps
	Output to Output Skew, 5PB1102/04	Industrial and Extended <sup>[1]</sup>	Rising edges at $V_{DD}/2$ . <sup>[4]</sup>		35	50	ps
	Output to Output Skew, 5PB1106	Industrial and Extended <sup>[1]</sup>	Rising edges at $V_{DD}/2$ . <sup>[4]</sup>		35	58	ps
	Output to Output Skew, 5PB1108/10	Industrial and Extended <sup>[1]</sup>	Rising edges at $V_{DD}/2$ . <sup>[4]</sup>		45	65	ps
	Output to Output Skew	Automotive <sup>[2]</sup>	Rising edges at $V_{DD}/2$ . <sup>[4]</sup>		35	87	ps
	Device to Device Skew	All devices	Rising edges at $V_{DD}/2$ .			200	ps
$t_{EN}$	Output Enable Time	All devices	$C_L \leq 5pF$ .			3	cycles
$t_{DIS}$	Output Disable Time	All devices	$C_L \leq 5pF$ .			3	cycles
$t_{DC}$	Duty Cycle <sup>[5]</sup>	All devices			50		%

<sup>1</sup> 5PB11xxPGGI, 5PB11xxPGGK, 5PB11xxCMGI, 5PB11xxCMGK.  $T_A = -40^\circ C$  to  $+105^\circ C$  unless stated otherwise.

<sup>2</sup> 5PB1104CMG1 and 5PB1104CMT1 only.  $T_A = -40^\circ C$  to  $+125^\circ C$  unless stated otherwise.

<sup>3</sup> With rail-to-rail input clock.

<sup>4</sup> Between any 2 outputs with equal loading.

<sup>5</sup> Duty cycle on outputs will match incoming clock duty cycle when  $V_{IH}$  on CLKIN pin equals  $V_{DD}$  power supply voltage. Consult IDT for tight duty cycle clock generators.

Table 10. AC Electrical Characteristics –  $V_{DD} = 2.5V \pm 5\%$ 

Symbol	Parameter	Applies to	Conditions	Minimum	Typical	Maximum	Units
	Input Frequency	All devices		0		200	MHz
$t_{OR}$	Output Rise Time (2pF load)	Industrial and Extended <sup>[1]</sup>	0.5V to 2.0V, $C_L = 2pF$ .		0.4	0.7	ns
$t_{OF}$	Output Fall Time (2pF load)	Industrial and Extended <sup>[1]</sup>	2.0V to 0.5V, $C_L = 2pF$ .		0.4	0.7	ns
$t_{OR}$	Output Rise Time (5pF load)	Industrial and Extended <sup>[1]</sup>	0.5V to 2.0V, $C_L = 5pF$ .		0.75	1.0	ns
$t_{OF}$	Output Fall Time (5pF load)	Industrial and Extended <sup>[1]</sup>	2.0V to 0.5V, $C_L = 5pF$ .		0.75	1.0	ns
$t_{OR}$	Output Rise Time (5pF load)	Automotive <sup>[2]</sup>	0.5V to 2.0V, $C_L = 5pF$ .		0.63	1.2	ns
$t_{OF}$	Output Fall Time (5pF load)	Automotive <sup>[2]</sup>	2.0V to 0.5V, $C_L = 5pF$ .		0.63	1.2	ns
$t_{START-UP}$	Start-up Time	All devices	Part start-up time for valid outputs after $V_{DD}$ ramp-up.			3	ms
$t_{PD}$	Propagation Delay, 5PB1102/04 <sup>[3]</sup>	Industrial and Extended <sup>[1]</sup>		1.9		2.9	ns
	Propagation Delay, 5PB1106/08 <sup>[3]</sup>	Industrial and Extended <sup>[1]</sup>		2.0		3.3	ns
	Propagation Delay, 5PB1110 <sup>[3]</sup>	Industrial and Extended <sup>[1]</sup>		2.0		3.0	ns
	Propagation Delay <sup>[3]</sup>	Automotive <sup>[2]</sup>		1.0		4.5	ns
	Buffer Additive Phase Jitter, RMS	Industrial and Extended <sup>[1]</sup>	156.25MHz, Integration Range: 12kHz–20MHz.			0.05	ps
		Automotive <sup>[2]</sup>	156.25MHz, Integration Range: 12kHz–20MHz.			0.06	ps
	Output to Output Skew, 5PB1102/04	Industrial and Extended <sup>[1]</sup>	Rising edges at $V_{DD}/2$ . <sup>[4]</sup>		35	50	ps
	Output to Output Skew, 5PB1106	Industrial and Extended <sup>[1]</sup>	Rising edges at $V_{DD}/2$ . <sup>[4]</sup>		35	58	ps
	Output to Output Skew, 5PB1108/10	Industrial and Extended <sup>[1]</sup>	Rising edges at $V_{DD}/2$ . <sup>[4]</sup>		45	65	ps
	Output to Output Skew	Automotive <sup>[2]</sup>	Rising edges at $V_{DD}/2$ . <sup>[4]</sup>		35	87	ps
	Device to Device Skew	All devices	Rising edges at $V_{DD}/2$ .			200	ps
$t_{EN}$	Output Enable Time	All devices	$C_L \leq 5pF$ .			3	cycles
$t_{DIS}$	Output Disable Time	All devices	$C_L \leq 5pF$ .			3	cycles
$t_{DC}$	Duty Cycle <sup>[5]</sup>	All devices			50		%

<sup>1</sup> 5PB11xxPGGI, 5PB11xxPGGK, 5PB11xxCMGI, 5PB11xxCMGK.  $T_A = -40^\circ C$  to  $+105^\circ C$  unless stated otherwise.

<sup>2</sup> 5PB1104CMG1 and 5PB1104CMT1 only.  $T_A = -40^\circ C$  to  $+125^\circ C$  unless stated otherwise.

<sup>3</sup> With rail-to-rail input clock.

<sup>4</sup> Between any 2 outputs with equal loading.

<sup>5</sup> Duty cycle on outputs will match incoming clock duty cycle when  $V_{IH}$  on CLKIN pin equals  $V_{DD}$  power supply voltage. Consult IDT for tight duty cycle clock generators.

Table 11. AC Electrical Characteristics –  $V_{DD} = 3.3V \pm 5\%$ 

Symbol	Parameter	Applies to	Conditions	Minimum	Typical	Maximum	Units
	Input Frequency	All devices		0		200	MHz
$t_{OR}$	Output Rise Time (2pF load)	Industrial and Extended <sup>[1]</sup>	0.66V to 2.64V, $C_L = 2pF$ .		0.45	0.6	ns
$t_{OF}$	Output Fall Time (2pF load)	Industrial and Extended <sup>[1]</sup>	2.64V to 0.66V, $C_L = 2pF$ .		0.45	0.6	ns
$t_{OR}$	Output Rise Time (5pF load)	Industrial and Extended <sup>[1]</sup>	0.66V to 2.64V, $C_L = 5pF$ .		0.7	1.0	ns
$t_{OF}$	Output Fall Time (5pF load)	Industrial and Extended <sup>[1]</sup>	2.64V to 0.66V, $C_L = 5pF$ .		0.7	1.0	ns
$t_{OR}$	Output Rise Time (5pF load)	Automotive <sup>[2]</sup>	0.66V to 2.64V, $C_L = 5pF$ .		0.61	1.2	ns
$t_{OF}$	Output Fall Time (5pF load)	Automotive <sup>[2]</sup>	2.64V to 0.66V, $C_L = 5pF$ .		0.61	1.2	ns
$t_{START-UP}$	Start-up Time	All devices	Part start-up time for valid outputs after $V_{DD}$ ramp-up.			3	ms
$t_{PD}$	Propagation Delay, 5PB1102/04 <sup>[3]</sup>	Industrial and Extended <sup>[1]</sup>		1.7		2.4	ns
	Propagation Delay, 5PB1106/08 <sup>[3]</sup>	Industrial and Extended <sup>[1]</sup>		1.7		2.7	ns
	Propagation Delay, 5PB1110 <sup>[3]</sup>	Industrial and Extended <sup>[1]</sup>		1.7		2.5	ns
	Propagation Delay <sup>[3]</sup>	Automotive <sup>[2]</sup>		1.0		3.4	ns
	Buffer Additive Phase Jitter, RMS	All devices	156.25MHz, Integration Range: 12kHz–20MHz.			0.05	ps
	Output to Output Skew, 5PB1102/04	Industrial and Extended <sup>[1]</sup>	Rising edges at $V_{DD}/2$ . <sup>[4]</sup>		35	50	ps
	Output to Output Skew, 5PB1106	Industrial and Extended <sup>[1]</sup>	Rising edges at $V_{DD}/2$ . <sup>[4]</sup>		35	58	ps
	Output to Output Skew, 5PB1108/10	Industrial and Extended <sup>[1]</sup>	Rising edges at $V_{DD}/2$ . <sup>[4]</sup>		45	65	ps
	Output to Output Skew	Automotive <sup>[2]</sup>	Rising edges at $V_{DD}/2$ . <sup>[4]</sup>		35	87	ps
	Device to Device Skew	All devices	Rising edges at $V_{DD}/2$ .			200	ps
$t_{EN}$	Output Enable Time	All devices	$C_L \leq 5pF$ .			3	cycles
$t_{DIS}$	Output Disable Time	All devices	$C_L \leq 5pF$ .			3	cycles
$t_{DC}$	Duty Cycle <sup>[5]</sup>	All devices			50		%

<sup>1</sup> 5PB11xxPGGI, 5PB11xxPGGK, 5PB11xxCMGI, 5PB11xxCMGK.  $T_A = -40^\circ C$  to  $+105^\circ C$  unless stated otherwise.

<sup>2</sup> 5PB1104CMG1 and 5PB1104CMT1 only.  $T_A = -40^\circ C$  to  $+125^\circ C$  unless stated otherwise.

<sup>3</sup> With rail-to-rail input clock.

<sup>4</sup> Between any 2 outputs with equal loading.

<sup>5</sup> Duty cycle on outputs will match incoming clock duty cycle when  $V_{IH}$  on CLKIN pin equals  $V_{DD}$  power supply voltage. Consult IDT for tight duty cycle clock generators.

## Phase Noise Plots

The phase noise plots show the low additive jitter of the 5PB11xx high-performance buffer. With an integration range of 12kHz to 20MHz, the reference input has about 58.9fs of RMS phase jitter while the output of 5PB11xx has about 70.9fs of RMS phase jitter. This results in a low additive phase jitter of only 39fs.

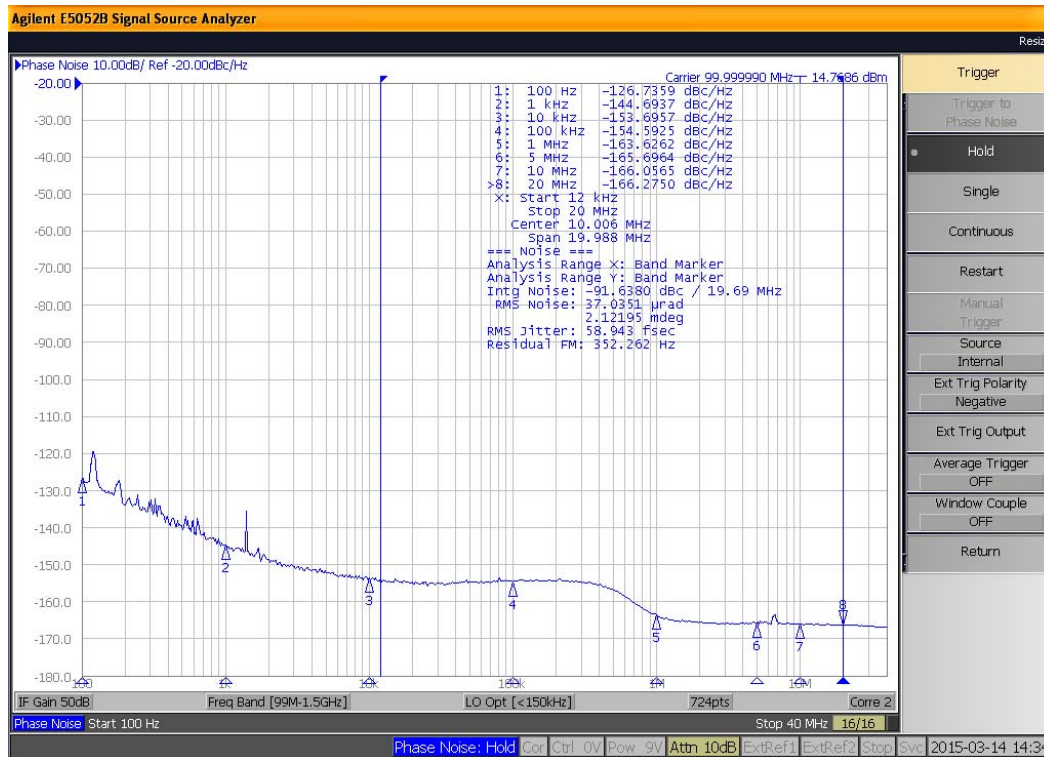

Reference Phase Noise 58.9fs (12kHz to 20MHz)

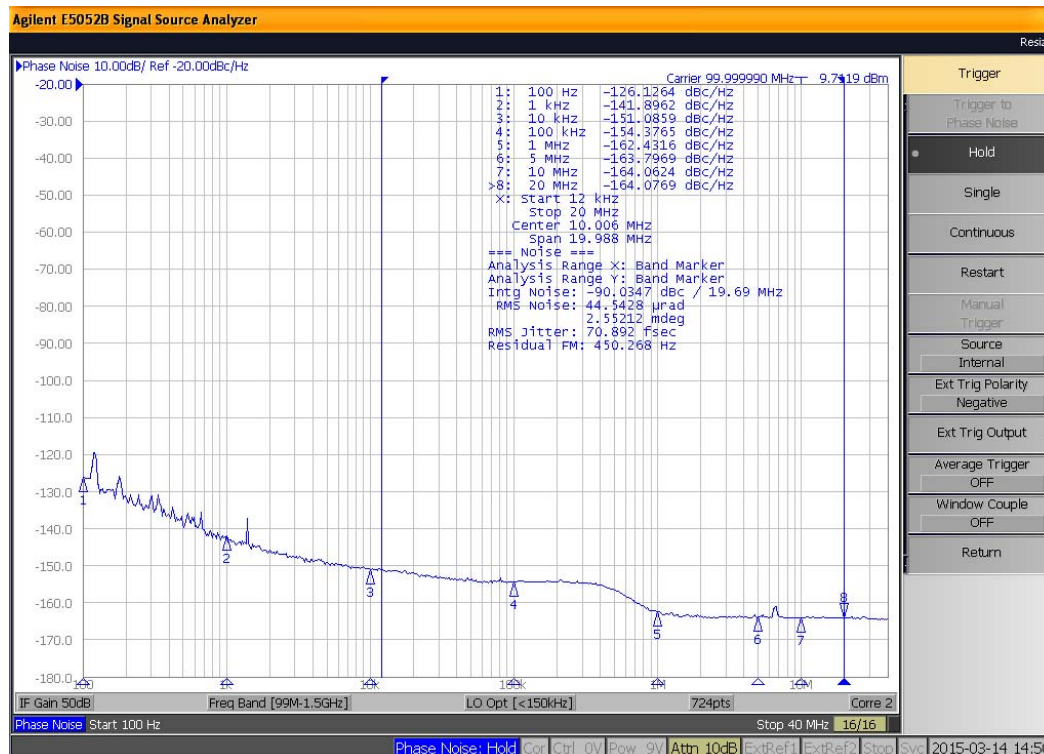

Output Phase Noise 70.9fs (12kHz to 20MHz)

## Test Load and Circuit

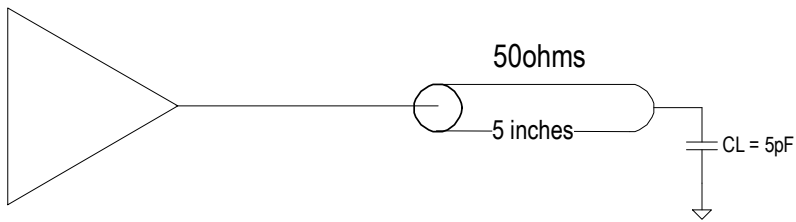

## Package Outline Drawings

The package outline drawings are appended at the end of this document and are accessible from the link below. The package information is the most current data available.

[www.idt.com/document/psc/8-tssop-package-outline-drawing-44-mm-body-065mm-pitch-pgg8d1](http://www.idt.com/document/psc/8-tssop-package-outline-drawing-44-mm-body-065mm-pitch-pgg8d1)

[www.idt.com/document/psc/14-tssop-package-outline-drawing-44mm-body-065mm-pitch-pgg14t1](http://www.idt.com/document/psc/14-tssop-package-outline-drawing-44mm-body-065mm-pitch-pgg14t1)

[www.idt.com/document/psc/16-tssop-package-outline-drawing-44mm-body-065mm-pitch-pgg16t1](http://www.idt.com/document/psc/16-tssop-package-outline-drawing-44mm-body-065mm-pitch-pgg16t1)

[www.idt.com/document/psc/20-tssop-package-outline-drawing-44-mm-body-065mm-pitch-pgg20d1](http://www.idt.com/document/psc/20-tssop-package-outline-drawing-44-mm-body-065mm-pitch-pgg20d1)

[www.idt.com/document/psc/cm8-package-outline-drawing-20-x-20-x-05-mm-body-05mm-pitch-dfn](http://www.idt.com/document/psc/cm8-package-outline-drawing-20-x-20-x-05-mm-body-05mm-pitch-dfn)

[www.idt.com/document/psc/cm16-package-outline-drawing-25-x-25-x-05-mm-body-040mm-pitch-vfqfn](http://www.idt.com/document/psc/cm16-package-outline-drawing-25-x-25-x-05-mm-body-040mm-pitch-vfqfn)

[www.idt.com/document/psc/20-vfqfn-package-outline-drawing-30-x-30-x-090-mm-040mm-pitch-165-x-165-mm-epad-ndg20p2](http://www.idt.com/document/psc/20-vfqfn-package-outline-drawing-30-x-30-x-090-mm-040mm-pitch-165-x-165-mm-epad-ndg20p2)

[www.idt.com/document/psc/dfn-8-package-outline-drawing-20-x-20-x-075-mm-body-050mm-pitch-cmt8d1](http://www.idt.com/document/psc/dfn-8-package-outline-drawing-20-x-20-x-075-mm-body-050mm-pitch-cmt8d1)

## Marking Diagrams (Industrial)

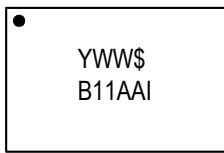

8-pin TSSOP

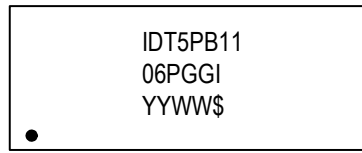

14-pin TSSOP

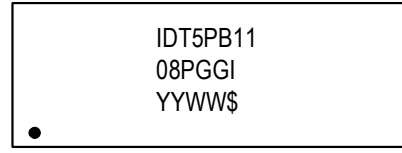

16-pin TSSOP

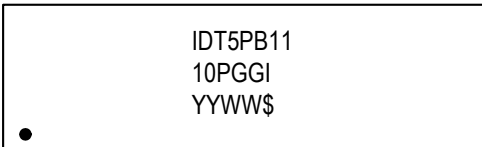

20-pin TSSOP

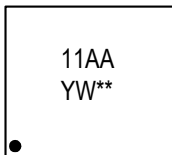

8-pin DFN

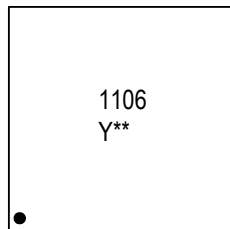

16-pin VFQFPN

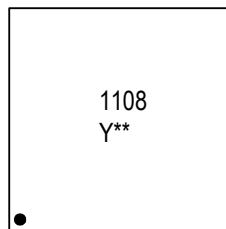

16-pin VFQFPN

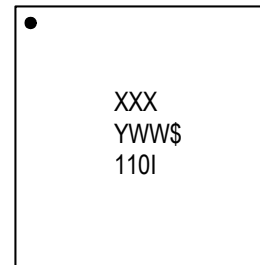

20-pin VFQFPN

- “AA” denotes the last two digits of the part number for 8-TSSOP and DFN (e.g. 02, 04).
- “\*\*\*” is the lot sequence.
- “XXX” denotes the last three characters of the Asm lot (20-VFQFPN only).
- “YYWW”, “YWW”, “YW”, or “Y” is the last digit(s) of the year and work week that the part was assembled.
- “\$” denotes the mark code.
- “G” after the two-letter package code denotes RoHS compliant package.
- “I” denotes industrial temperature range device.
- Bottom marking: LOT and COO (TSSOP only).

## Marking Diagrams (Extended)



8-pin TSSOP

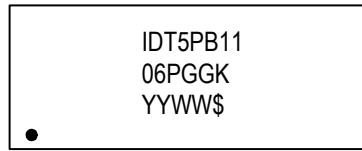

14-pin TSSOP

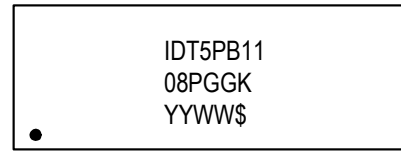

16-pin TSSOP

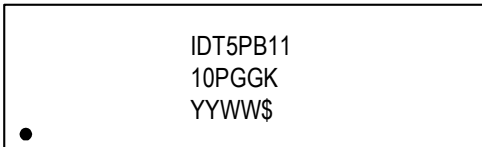

20-pin TSSOP



8-pin DFN

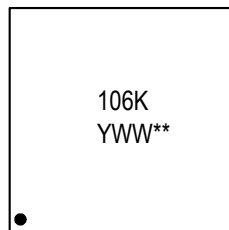

16-pin VFQFPN

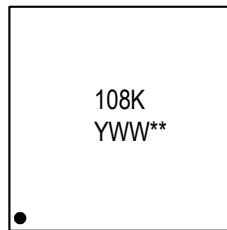

16-pin VFQFPN

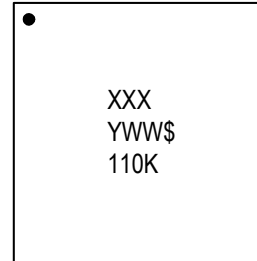

20-pin VFQFPN

- “AA” denotes the last two digits of the part number for 8-TSSOP and DFN (e.g. 02, 04).
- “\*\*” is the lot sequence.
- “XXX” denotes the last three characters of the Asm lot (20-VFQFPN only).
- “YYWW”, “YWW”, “YW”, or “Y” is the last digit(s) of the year and week that the part was assembled.
- “\$” denotes the mark code.
- “G” after the two-letter package code denotes RoHS compliant package.
- “K” denotes extended temperature range device.
- Bottom marking: LOT and COO (TSSOP only).

## Marking Diagrams (Automotive)

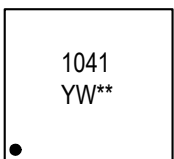

8-pin DFN

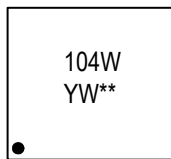

8-pin DFN (wetable flank)

- Line 1: truncated part number; last number is the temperature grade: 1 = Automotive Grade 1.
- “YW” is the last digit of the year and work week that the part was assembled.
- “\*\*” denotes the lot sequence number.



## Ordering Information (Industrial)

Orderable Part Number	Package	Carrier Type	Temperature
5PB1102PGGI	4.4mm body, 8-TSSOP	Tubes	-40 to +85°C
5PB1102PGGI8		Tape and Reel	
5PB1104PGGI		Tubes	
5PB1104PGGI8		Tape and Reel	
5PB1106PGGI	4.4mm body, 14-TSSOP	Tubes	
5PB1106PGGI8		Tape and Reel	
5PB1108PGGI	4.4mm body, 16-TSSOP	Tubes	
5PB1108PGGI8		Tape and Reel	
5PB1110PGGI	4.4mm body, 20-TSSOP	Tubes	
5PB1110PGGI8		Tape and Reel	
5PB1102CMGI	2.0 × 2.0 × 0.5 mm, 8-DFN	Cut Tape	
5PB1102CMGI8		Tape and Reel	
5PB1104CMGI		Cut Tape	
5PB1104CMGI8		Tape and Reel	
5PB1104CMGI/W*		Tape and Reel	
5PB1106CMGI	2.5 × 2.5 × 0.5 mm, 16-VFQFPN	Cut Tape	
5PB1106CMGI8		Tape and Reel	
5PB1108CMGI		Cut Tape	
5PB1108CMGI8		Tape and Reel	
5PB1110NDGI	3.0 × 3.0 × 0.90 mm, 20-VFQFPN	Tubes	
5PB1110NDGI8		Tape and Reel	

\* "/W" stands for tape and reel with pin 1 orientation: EIA-481-D. All other tape and reels options come with EIA-481-C pin 1 orientation.

## Ordering Information (Extended)

Orderable Part Number	Package	Carrier Type	Temperature
5PB1102PGGK	4.4mm body, 8-TSSOP	Tubes	-40 to +105°C
5PB1102PGGK8		Tape and Reel	
5PB1104PGGK		Tubes	
5PB1104PGGK8		Tape and Reel	
5PB1106PGGK	4.4mm body, 14-TSSOP	Tubes	
5PB1106PGGK8		Tape and Reel	
5PB1108PGGK	4.4mm body, 16-TSSOP	Tubes	
5PB1108PGGK8		Tape and Reel	
5PB1110PGGK	4.4mm body, 20-TSSOP	Tubes	
5PB1110PGGK8		Tape and Reel	
5PB1102CMGK	2.0 × 2.0 × 0.5 mm, 8-DFN	Cut Tape	
5PB1102CMGK8		Tape and Reel	
5PB1104CMGK		Cut Tape	
5PB1104CMGK8		Tape and Reel	
5PB1106CMGK	2.5 × 2.5 × 0.5 mm, 16-VFQFPN	Cut Tape	
5PB1106CMGK8		Tape and Reel	
5PB1108CMGK		Cut Tape	
5PB1108CMGK8		Tape and Reel	
5PB1110NDGK	3.0 × 3.0 × 0.90 mm, 20-VFQFPN	Tubes	
5PB1110NDGK8		Tape and Reel	

“G” after the two-letter package code denotes Pb-Free configuration, RoHS compliant.

## Ordering Information (Automotive)

Orderable Part Number	Package	Carrier Type	Temperature
5PB1104CMG1	2.0 × 2.0 × 0.5 mm, 8-DFN	Cut Tape	-40° to +125°C
5PB1104CMG18		Tape and Reel	
5PB1104CMT1	2.0 × 2.0 × 0.5 mm, 8-DFN, Wettable flank	Cut Tape	-40° to +125°C
5PB1104CMT18		Tape and Reel	

## Revision History

Revision Date	Description of Change
May 31, 2019	<ul style="list-style-type: none"> <li>▪ Added 5PB1104CMT1 wettable flank package information.</li> <li>▪ Updated Propagation Delay values for automotive.</li> </ul>
December 18, 2018	<ul style="list-style-type: none"> <li>▪ Updated <math>t_{PD}</math> and skew values.</li> <li>▪ Added 5PB1104CMG1 automotive part information.</li> </ul>
October 24, 2018	Initial release.



Corporate Headquarters  
 6024 Silver Creek Valley Road  
 San Jose, CA 95138 USA  
[www.IDT.com](http://www.IDT.com)

Sales  
 1-800-345-7015 or 408-284-8200  
 Fax: 408-284-2775  
[www.IDT.com/go/sales](http://www.IDT.com/go/sales)

Tech Support  
[www.IDT.com/go/support](http://www.IDT.com/go/support)

DISCLAIMER Integrated Device Technology, Inc. (IDT) and its affiliated companies (herein referred to as "IDT") reserve the right to modify the products and/or specifications described herein at any time, without notice, at IDT's sole discretion. Performance specifications and operating parameters of the described products are determined in an independent state and are not guaranteed to perform the same way when installed in customer products. The information contained herein is provided without representation or warranty of any kind, whether express or implied, including, but not limited to, the suitability of IDT's products for any particular purpose, an implied warranty of merchantability, or non-infringement of the intellectual property rights of others. This document is presented only as a guide and does not convey any license under intellectual property rights of IDT or any third parties.

IDT's products are not intended for use in applications involving extreme environmental conditions or in life support systems or similar devices where the failure or malfunction of an IDT product can be reasonably expected to significantly affect the health or safety of users. Anyone using an IDT product in such a manner does so at their own risk, absent an express, written agreement by IDT.

Integrated Device Technology, IDT and the IDT logo are trademarks or registered trademarks of IDT and its subsidiaries in the United States and other countries. Other trademarks used herein are the property of IDT or their respective third party owners. For datasheet type definitions and a glossary of common terms, visit [www.idt.com/go/glossary](http://www.idt.com/go/glossary). Integrated Device Technology, Inc. All rights reserved.

Компания «Океан Электроники» предлагает заключение долгосрочных отношений при поставках импортных электронных компонентов на взаимовыгодных условиях!

Наши преимущества:

- Поставка оригинальных импортных электронных компонентов напрямую с производств Америки, Европы и Азии, а так же с крупнейших складов мира;
- Широкая линейка поставок активных и пассивных импортных электронных компонентов (более 30 млн. наименований);
- Поставка сложных, дефицитных, либо снятых с производства позиций;
- Оперативные сроки поставки под заказ (от 5 рабочих дней);
- Экспресс доставка в любую точку России;
- Помощь Конструкторского Отдела и консультации квалифицированных инженеров;
- Техническая поддержка проекта, помощь в подборе аналогов, поставка прототипов;
- Поставка электронных компонентов под контролем ВП;
- Система менеджмента качества сертифицирована по Международному стандарту ISO 9001;
- При необходимости вся продукция военного и аэрокосмического назначения проходит испытания и сертификацию в лаборатории (по согласованию с заказчиком);
- Поставка специализированных компонентов военного и аэрокосмического уровня качества (Xilinx, Altera, Analog Devices, Intersil, Interpoint, Microsemi, Actel, Aeroflex, Peregrine, VPT, Syfer, Eurofarad, Texas Instruments, MS Kennedy, Miteq, Cobham, E2V, MA-COM, Hittite, Mini-Circuits, General Dynamics и др.);

Компания «Океан Электроники» является официальным дистрибьютором и эксклюзивным представителем в России одного из крупнейших производителей разъемов военного и аэрокосмического назначения «**JONHON**», а так же официальным дистрибьютором и эксклюзивным представителем в России производителя высокотехнологичных и надежных решений для передачи СВЧ сигналов «**FORSTAR**».



## JONHON

«**JONHON**» (основан в 1970 г.)

Разъемы специального, военного и аэрокосмического назначения:

(Применяются в военной, авиационной, аэрокосмической, морской, железнодорожной, горно- и нефтедобывающей отраслях промышленности)

«**FORSTAR**» (основан в 1998 г.)

ВЧ соединители, коаксиальные кабели, кабельные сборки и микроволновые компоненты:

(Применяются в телекоммуникациях гражданского и специального назначения, в средствах связи, РЛС, а так же военной, авиационной и аэрокосмической отраслях промышленности).



Телефон: 8 (812) 309-75-97 (многоканальный)

Факс: 8 (812) 320-03-32

Электронная почта: [ocean@oceanchips.ru](mailto:ocean@oceanchips.ru)

Web: <http://oceanchips.ru/>

Адрес: 198099, г. Санкт-Петербург, ул. Калинина, д. 2, корп. 4, лит. А