

## Multi-point Temperature Controller

## E5ZE-8□-E

Control Up to Eight Zones, Provides Serial Communications

- Applications include plastic injection and extrusion machines, and continuous temperature control processes
- Fuzzy control can be used to enhance PID control response
- Fast sampling rate of 0.2 s for 8 inputs
- Heating only or heating/cooling output models available to match applications
- Optional 1/4 DIN size Display Unit shows temperature and settings
- Use SYS-Config software for setup programming and monitoring
- 3-year warranty



## Ordering Information

Order control output, heater burnout/SSR failure, and communication boards separately.

### ■ TEMPERATURE CONTROLLERS

Number of points controlled	Control method	Part number	
		Thermocouple input	Platinum resistance thermometer input
8	Heating (standard), See Note	E5ZE-8AAAMTCB-E	E5ZE-8AAAMPB-E
	Heating/cooling	E5ZE-8VAAMTCB-E	E5ZE-8VAAMPB-E

Note: The output operation can be switched to provide cooling control.

### ■ INPUT AND OUTPUT BOARDS

Description	Specifications	Max. quantity	Part number
Control output board	Voltage output, 8 points, 30 mA per point max. at 12 VDC	1	E53-E8Q
	Current output, 8 points, 4 to 20 mA, 600 Ω per point		E53-E8C
Current transformer input board	Accepts input for heater burnout/SSR failure alarm (See Note)	1	E54-E8CT
Serial communications	RS-232C, one-to-one communications, 25-pin D-sub connector	1	E53-E01
	RS-422/RS-485, multi-drop line, 5-pole terminal block		E53-E04

Note: The heater burnout/SSR failure detection function will not operate correctly if the heating control output is a current output.

## Temperature Ranges

Input		Temperature range		Setting (See Note 1)	Minimum units
Thermocouple	K (CA)	−200°C to 1,300°C	−300°F to 2,300°F	0	1°C or 0.1°C
	J (IC)	−100°C to 850°C	−100°F to 1,500°F	1	
	R	0°C to 1,700°C	0°F to 3,000°F	2	
	S	0°C to 1,700°C	0°F to 3,000°F	3	
	T (CC)	−200°C to 400°C	−300°F to 700°F	4	
	E (CRC)	0°C to 600°C	0°F to 1,100°F	5	
	B	100°C to 1,800°C	300°F to 3,000°F	6	
	N	0°C to 1,300°C	0°F to 2,300°F	7	
	L	−100°C to 850°C	−100°F to 1,500°F	8	
	U	−200°C to 400°C	−300°F to 700°F	9	
	W	0°C to 2,300°C	32°F to 4,100°F	A	
Platinum resistance thermometer	PL II (See Note 2)	0°C to 1,300°C	0°F to 2,300°F	B	
	Pt100	−100.0°C to 500.0°C	−100.0°F to 900.0°F	0	
	JPt100	−100.0°C to 500.0°C	−100.0°F to 900.0°F	1	

- Note: 1. The factory setting is 0 (Type K for thermocouple input or Pt100 for platinum resistance thermometer input.)  
 2. Platinel is a registered trademark of Englehard Industries.

## ■ ACCESSORIES (ORDER SEPARATELY)

Description	Specifications	Part number
Display unit shows settings, allows programming without software; 1/4 DIN size	RS-232C connector, 100 to 240 VAC, 50/60 Hz supply voltage	E5ZD-SDL1 AC100-240
	RS-232C connector, 24 VDC supply voltage	E5ZD-SDL1 24V/DC
	RS-422 terminal block, 100 to 240 VAC, 50/60 Hz supply voltage	E5ZD-SDL2X AC100-240
	RS-422 terminal block, 24 VDC supply voltage	E5ZD-SDL2X 24V/DC
	RS-485 terminal block, 100 to 240 VAC, 50/60 Hz supply voltage	E5ZD-SDL3X AC100-240
	RS-485 terminal block, 24 VDC supply voltage	E5ZD-SDL3X 24V/DC
	1.5 m length cable from E5ZE to Display Unit, RS-232C with 25-pin connector	ES100-CT022-202
	1.5 m length cable from E5ZE to Display Unit, RS-232C with 9-pin connector	ES100-CT023-202
Current transformer; order only if using heater burnout alarm function	50 A load, 5.8 mm hole dia.	E54-CT1
	120 A load, 12 mm hole dia.	E54-CT3
Software	For setup and monitoring	SYS-CONFIG V2.0
I/O cable to E5ZE	2 m length cable connects XW2B-20G4 or XW2B-20G5 screw terminals for control and current transformer inputs and alarm outputs; order 3 cables	E5ZE-CBL200

## ■ WIRE-SAVING SOLUTIONS

Description	Specifications	Part number
Screw terminals	20-pole, M3 screw terminals, flat cable connector	XW2B-20G4
	20-pole, M3.5 screw terminals, MIL-type connector	XW2B-20G5
Relay output blocks	8-pt relay output (SPST-NO) with NPN DC coil (+ common)	G7TC-OC08 DC24V
	8-pt relay output (SPST-NO) with PNP DC coil (− common)	G7TC-OC08-1 DC24V
	16-pt relay output (SPST-NO) with NPN DC coil (+ common)	G7TC-OC16 DC24V
	16-pt relay output (SPST-NO) with PNP DC coil (− common)	G7TC-OC16-1 DC24V

## Application Examples

### ■ INJECTION MOLDING MACHINE

Use one of E5ZE's inputs to control preheating of the hopper materials. The other seven sensors can be used to check temperature in multiple molds.

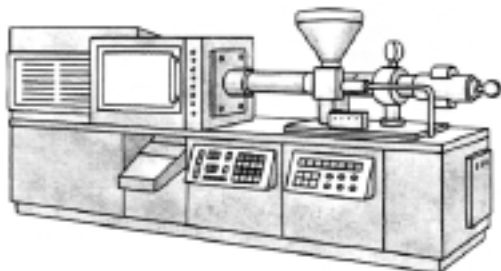

### ■ REFLOW SOLDERING MACHINE

Control multiple heating zones to ensure proper solder processing. The E5ZE's eight inputs can control pre-heating of circuit boards, soldering process and the cool down area.

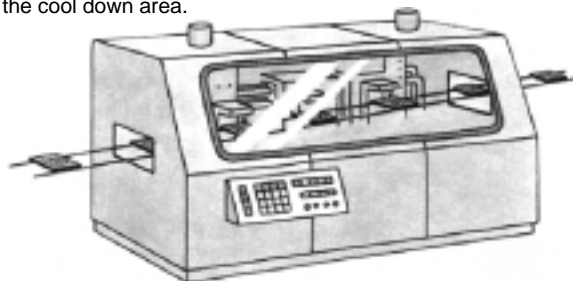

## Specifications

### ■ RATINGS

Rated voltage		24 VDC
Permissible voltage fluctuation		85 to 110% of rated voltage
Power consumption		15 W +20% max. at 24 V DC
Analog inputs	Inputs	Thermocouple: K, J, T, E, L, U, N, R, S, B, W, and PL II Platinum resistance thermometer: JPt 100, Pt 100
	Input impedance	Thermocouple: 1 MΩ min.
	Rated current of platinum resistance thermometer	1 mA
Control outputs	Voltage output (with short-circuit protection)	ON voltage: 12 ±1.2 VDC OFF voltage: 0.5 VDC max. Max. load current: 30 mA/output
	Current output	Rated output range: 4 to 20 mA (4 +0/-0.6 mA for 0% output, 20 +2/-0 mA for 100% output) Max. load resistance: 600 Ω/output
	Open-collector NPN output (cooling only)	Max. voltage: 30 VDC Max. load current: 50 mA/output Residual voltage when ON: 2 VDC max. Leakage current when OFF: 1 mA max.
Alarm outputs		Temperature alarms: Two outputs: alarm 1 and alarm 2 for all outputs in each word. HB alarm (heater burnout detection): One output for all outputs in each word. HS alarm (SSR fault detection): One output for all outputs in each word. Temperature controller error output (memory, set value, or hardware error): One output All outputs are NPN open-collector outputs with a max. voltage of 30 VDC and max. load current of 50 mA/output.
Number of inputs		8 input points and 8 control points
Setting method		Set by communications
Control method		ON/OFF, hybrid of advanced PID and fuzzy logic control, or manual operation
Memory bank input		8 points for each control point Designated through communication or memory bank designation input
Memory bank designation inputs		With contact signal input: ON short-circuit resistance: 1 kΩ max. OFF open resistance: 100 kΩ min. With non-contact signal input: ON residual voltage: 2 VDC max. OFF leakage current: 1 mA DC max.
Ambient temperature		Operating: -10°C to 55°C (14°F to 131°F) with no icing or condensation Storage: -25°C to 65°C (-13°F to 149°F) with no icing or condensation
Ambient humidity		Operating: 35% to 85% RH Storage: 35% to 95% RH

## ■ CHARACTERISTICS

Measurement precision	Thermocouple: (±0.3% of the measured value or ±2°C, whichever is larger) ±1 digit max. (±0.3% of the measured value or ±3.6°F, whichever is larger) ±1 digit max. Platinum resistance thermometer: (±0.3% of the measured value or ±0.8°C, whichever is larger) ±1 digit max. (±0.3% of the measured value or ±1.5°F, whichever is larger) ±1 digit max.
Adjustable sensitivity	0.0°C to 99.9°C or 0.0°F to 99.9°F (0.1° increments), valid for ON/OFF control only.
Cooling coefficient	0.0 to 10.0 (0.1 increments)
Proportional band	0.0°C to 999.9°C or 0.0°F to 999.9°F (0.1° increments) Cooling: cooling coefficient × proportional band
Integral time	0 to 3,999 s (1-s increments)
Derivative time	0 to 3,999 s (1-s increments)
Control cycle	Heating or cooling: 1 to 99 s (1-s increments)
Sampling cycle	Approx. 200 ms/8 control points
Dead band/overlap Band	–999° to 999° (1° C or F increments)
Alarm set range	With 1° increments: –999° to 9,999° (0° to 9,999° with upper/lower limit alarms) With 0.1° increments: –999.9° to 9,999.9° (0.0° to 9,999.9° with upper/lower limit alarms)
Fuzzy logic strength	0 to 99% (1% increments)
Fuzzy logic scale 1	0.2° to 999.9° (0.1° C or F increments)
Fuzzy logic scale 2	0.02° to 99.99° (0.01° C or F increments)
SV protection	Lithium battery backup
SV protection time	10 years min. at room temperature
Insulation resistance	20 MΩ at 500 VDC between the FG terminal and analog input terminals
Dielectric strength	Leakage current of 1 mA max. between the FG terminal and analog input terminals when 500 VAC is applied for 1 min.
Vibration resistance	Malfunction: 10 to 55 Hz with 15 m/s <sup>2</sup> (1G) for 10 minutes each in X, Y, and Z directions Destruction: 10 to 55 Hz with 20 m/s <sup>2</sup> (2G) for 2 hours each in X, Y, and Z directions
Shock resistance	Malfunction: 150 m/s <sup>2</sup> (15.3G) max. 3 times each in ±X, ±Y, and ±Z directions Destruction: 200 m/s <sup>2</sup> (20.4G) max. 3 times each in ±X, ±Y, and ±Z directions
Enclosure rating	IP00
Weight	Enclosed Unit: 1,700 g max. Open frame: 900 g max.
EMC	Emission Enclosure EN55011 Group1 class A Immunity ESD: EN61000-4-2: 4 kV contact discharge (level 2) 8 kV air discharge (level 3) Immunity RF-interference: ENV50140: 10 V/M amplitude modulated, 80 MHz to 1 GHz (level 3) 10 V/m (pulse modulated, 900 MHz) Immunity conducted disturbance: ENV50141: 10 V (0.15 to 80 MHz) level 30) Immunity burst: EN61000-4-4: 2 kV power line (level 3)
Approved standards	Conforms to EN50081-2, EN50082-2 (See Note 3)

Note: 1. The measurement accuracy of the E5ZE used with a thermocouple B at 400°C or 750°F max. is not guaranteed. The following measurement accuracy values are applied to the E5ZE.

K and T at –100°C max. and U: ±3°C ±1 digit max.

K and T at –100°F max. and U: ±5.4°F ±1 digit max.

R, S, and W at 200°C max., and B at 1,000°C max.: ±4°C ±1 digit max.

R, S, and W at 400°F max., and B at 1,800°F max.: ±7.2°F ±1 digit max.

2. The measurement accuracy of the E5ZE used with any thermocouple is 1°C/°F. The thermocouple can be used under the following temperature ranges to increase the measurement accuracy to as high as 0.1°C/°F.

K thermocouple: 0.0 °C to 1,300.0 °C, 0.0 °F to 2,300.0 °F

T or U thermocouple: 0.0 °C to 400.0 °C, 0.0 °F to 700.0 °F

N thermocouple: 400.0 °C to 1,300.0 °C, 700.0 °F to 2,300.0 °F

J, E, L, or PLII thermocouple: Any temperature

3. To ensure EMC conformance, refer to Wiring for Conformance to the EMC Directives at the end of this data sheet.

## ■ DISPLAY UNIT

### Ratings

Supply voltage	100 to 240 VAC, 50/60 Hz or 24 VDC
Operating voltage range	85% to 110% of rated supply voltage
Power consumption	Approx. 8 VA at 100 VAC to 12 VA at 420 VAC; approx. 5 W at 24 VDC
Setting method	Digital setting via Up and Down keys
Display method	LED character heights: PV: 15 mm (red); SV: 11 mm (green); UNIT/CH/BK: 11 mm (orange)
Other functions	Key protection Display group selection Display scan function

### Characteristics

Sampling period	500 ms, 1 s (selectable)
Enclosure ratings	Front panel: IP50 Rear case: IP20 Terminals: IP00
Vibration resistance	Malfunction: 2 to 55 Hz, 19.6 m/s <sup>2</sup> for 10 min each in X, y, and Z directions
Shock resistance	Malfunction: 196 m/s <sup>2</sup> for 3 times in each of 6 directions
Ambient temperature	-10°C to 55°C (4°F to 131°F) with no icing
Ambient humidity	35% to 85% RH
Weight	Approx. 450 g

## ■ COMMUNICATIONS

Communications type	RS-232C	RS-422	RS-485
Maximum total cable length	15 m	500 m	500 m
Communications method	Half-duplex		
Connection method	25-pin D-sub connector	5-pole terminal block with M3 screws	
Transmission line configuration	3-wire	4-wire	2-wire
Transmission line type	Direct line	Multi-drop line	
Synchronization method	Start-stop synchronization (asynchronous)		
Baud rate	2,400/4,800/9,600/19,200 bps		
Transmission code	ASCII		
Number of stop bits	2		
Parity	Even parity		
Character length	7 bits		
Error detection	Vertical parity and FCS (frame check sequence)		
Communications unit number	0 to F (hexadecimal)		
Transmission and reception switching time	—	20 ms max.	
Temperature controllers connected to single host computer	—	16 max.	

### Functions Set via Communications

- Set point
- Process value
- Alarm value
- Alarm mode
- Hysteresis
- Proportional band
- Integral time
- Derivative timer
- Output value
- Auto-turning (AT) start–stop
- Heater burnout detection set value
- Control start/stop
- Control memory bank
- Cooling start/stop
- Control memory bank
- Cooling coefficient\*
- Deadband/overlap band\*
- Fuzzy strength
- Fuzzy scale 1, 2

\*Heating and cooling control models only

# Nomenclature

## Display Unit E5ZD-SDL1

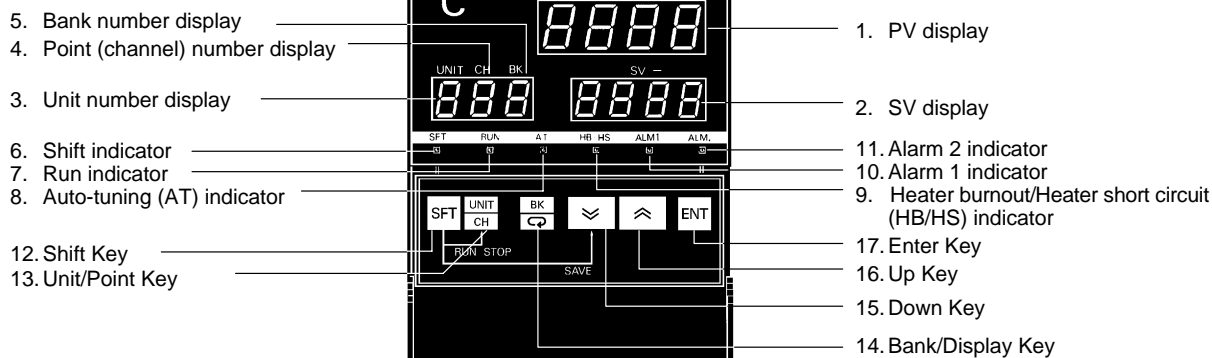

## Display

No.	Display	Meaning
1	Process Value (PV) display	The measured temperature and the set item characters are displayed according to the display mode. An error message is displayed if the system has an error. - is displayed for the leftmost digit of a figure between -1,000 and -1,999.
2	Set Value (SV) display	The value that has been set is displayed according to the display mode. An error message is displayed if the system has an error. - is displayed for the leftmost digit of a figure between -1,000 and -1,999.
3	Unit number display	The unit number that has been selected is displayed.
4	Point number display	The point number that has been selected is displayed.
5	Bank number display	The bank number that has been selected is displayed.
6	Shift indicator	Lit at the time of key shift.
7	Run indicator	Lit when the displayed unit is being controlled.
8	Auto-tuning (AT) indicator	Flashes while auto-tuning is being executed.
9	Heater burnout/Heater short circuit (HB/HS) alarm indicator	Lit when heater burnout or heater short circuit alarm output is ON.
10	Alarm 1 indicator	Lit when alarm output 1 is ON.
11	Alarm 2 indicator	Lit when alarm output 2 is ON.

## Key

No.	Key	Meaning
12	Shift Key	Turns ON or OFF the shift indicator.
13	Unit/Point Key	Displays the next point number while the shift display is OFF. Any invalid point is skipped.  Displays the next unit number while the shift display is ON. A, b, c, d, E, and F are displayed for the 10th unit number and the succeeding unit numbers.  - : All points - : All units
14	Bank/Display Key	Displays the next display mode while the shift display is OFF. Displays the next bank number when the shift display is lit.  - : All banks
15	Down Key	Decreases the set value within the available setting range. The set value decreases continuously if this key is pressed for 0.5 s or more. Note: This key does not function if the key protect switch is turned ON.
16	Up Key	Increases the set value within the available setting range. The set value increases continuously if this key is pressed for 0.5 s or more. Note: This key does not function if the key protect switch is turned ON.
17	Enter Key	Writes the set value to the E5ZE Temperature Controller. Note: This key does not function if the key protect switch is turned ON.

# Operation

## ■ SYSTEM CONFIGURATION

### Devices Connectable to the E5ZE

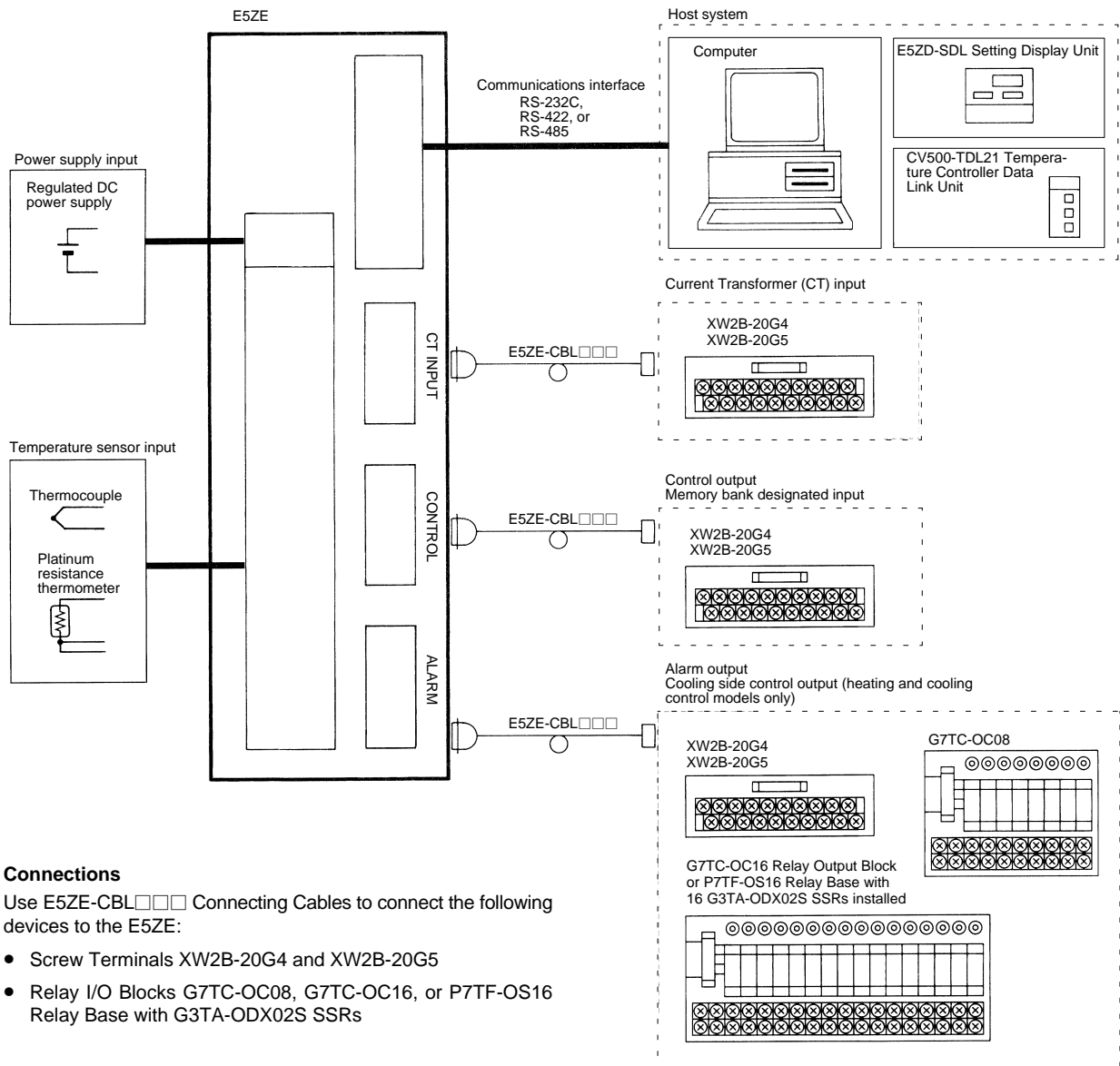

### Connections

Use E5ZE-CBL□□□ Connecting Cables to connect the following devices to the E5ZE:

- Screw Terminals XW2B-20G4 and XW2B-20G5
- Relay I/O Blocks G7TC-OC08, G7TC-OC16, or P7TF-OS16 Relay Base with G3TA-ODX02S SSRs



### Caution

Do not connect any device other than those listed above to the E5ZE using E5ZE-CBL□□□ Connecting Cables, or the E5ZE may malfunction or accidents may result.

# Dimensions

Unit: mm (inch)

## TEMPERATURE CONTROLLERS

### E5ZE-8□AAM□B-E

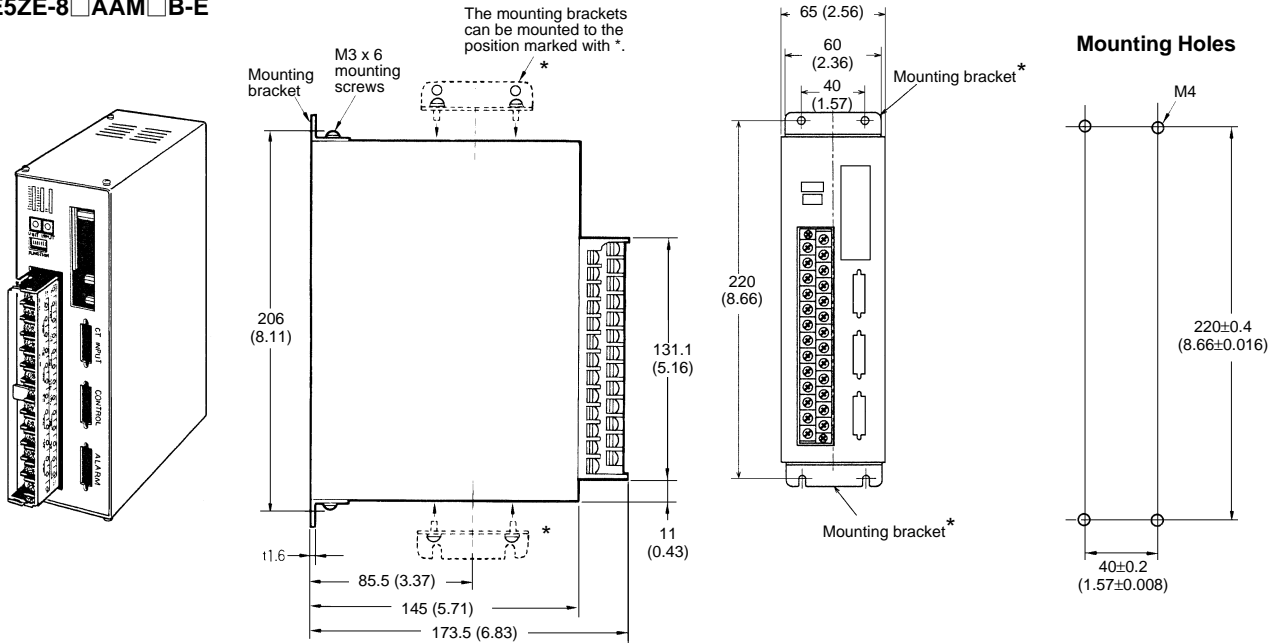

### Panel-mounting Screws

Prepare the following screws.

- Size: M3 x □
- $t + t_1 + t_2 + 2.5 < \square < t + t_1 + t_2 + 7.8$
- t: Panel thickness
- t<sub>1</sub>: Spring washer thickness
- t<sub>2</sub>: Flat washer thickness
- Material: Iron or stainless

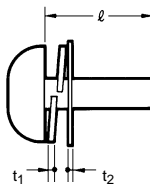

### Mounting Stud

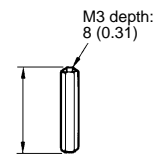

## DISPLAY UNIT

### E5ZD-SDL

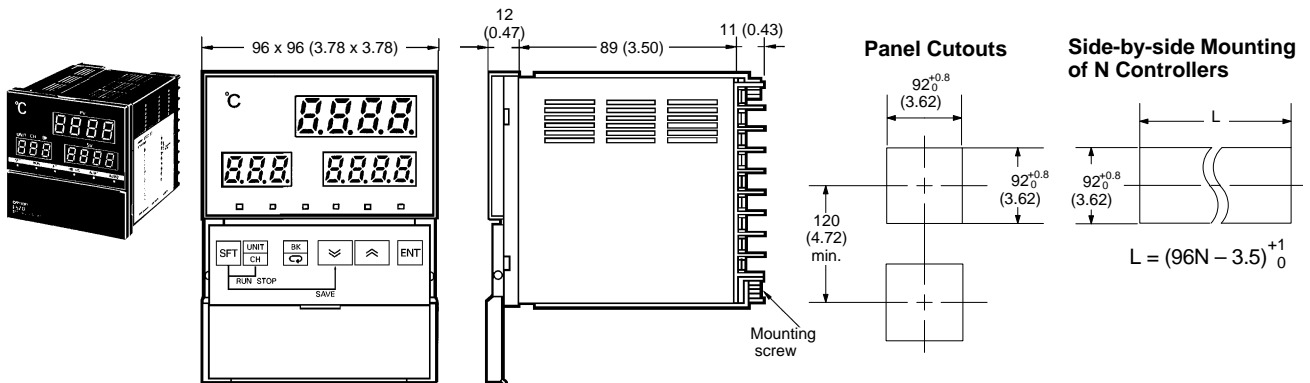



# Installation

## EXTERNAL CONNECTION

### Terminal Block Connections

#### Thermocouple

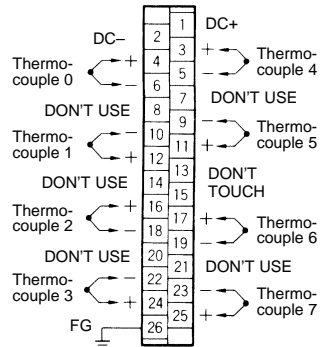

#### Platinum Resistance Thermometer

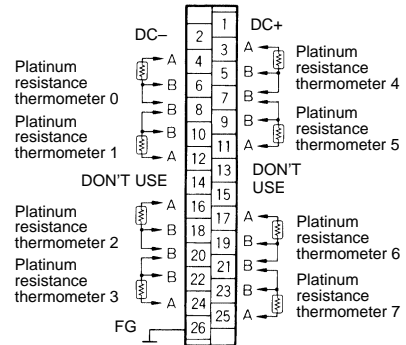

A thermocouple has polarity. Connect thermocouples to the terminal block correctly using compensating conductor that are suitable for the thermocouples.

Be sure to use the cold junction compensator (no. 13 and 15) provided with the E5ZE. The lot and serial numbers of the cold junction compensator must be identical to those of the E5ZE. Do not touch the cold junction compensator while operating E5ZE.

The number of each of the above thermocouples is a point number.

Make sure there is no difference in resistance among the three conductor of each platinum resistance thermometer used with the E5ZE.

Do not short-circuit terminals 7, 8, 20, and 21.

The number of each of the above platinum resistance thermometer is a point number.

### Connecting to Screw Terminal Blocks

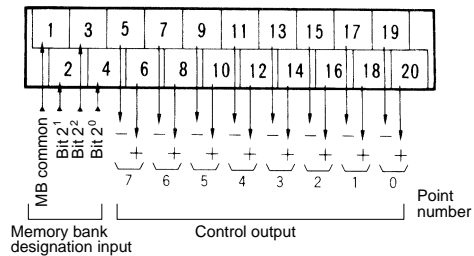
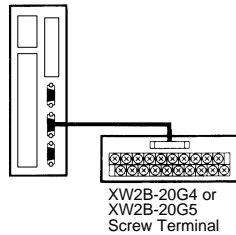

### Current Transformer (CT) Input

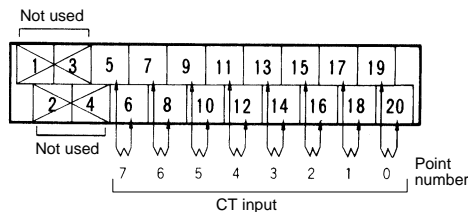
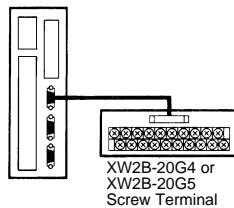

Alarm Output and Cooling Side Control Output (For Heating and Cooling Control Model Only)

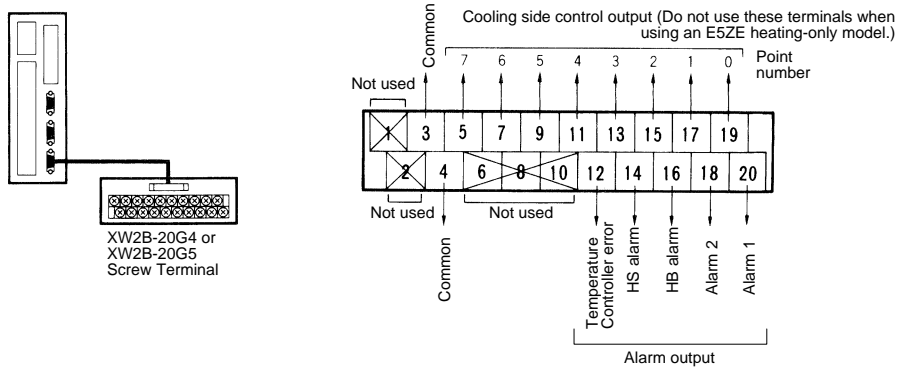

Connecting to G7TC-OC□□ Relay I/O Block

G7TC-OC08 Alarm Output

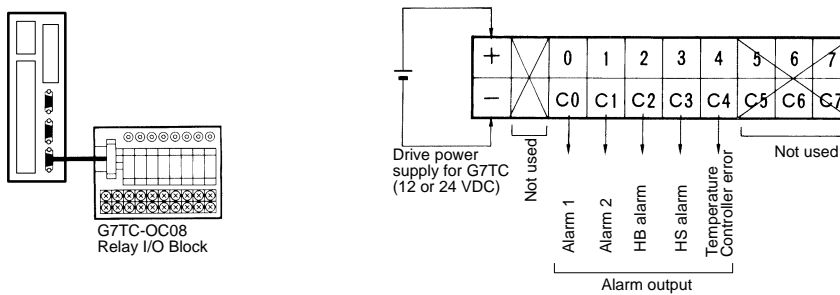

G7TC-OC16 Alarm Output and Cooling Side Control Output (For Heating and Cooling Control Models Only)

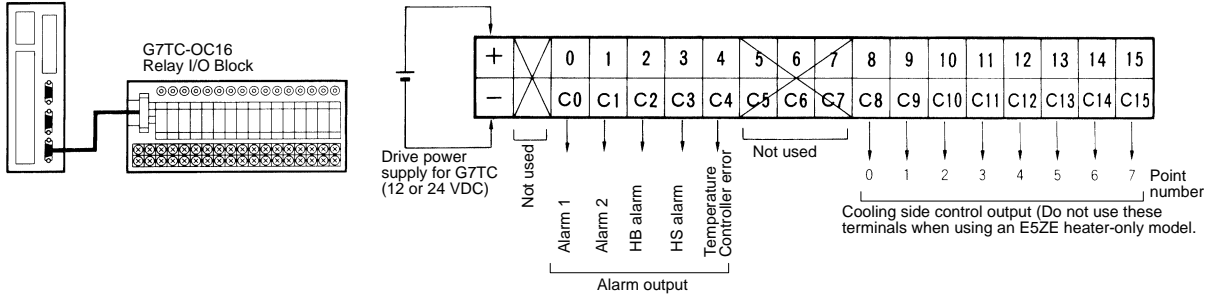

Communication Interfaces

RS-232C

Pin Assignments

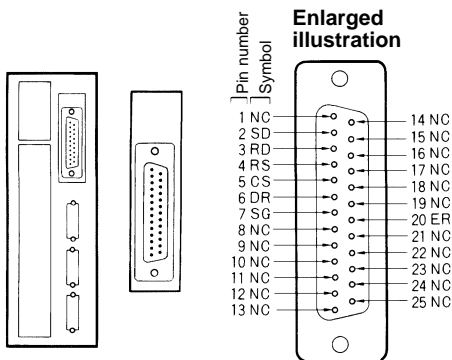

Signal name	Symbol	Signal direction	Pin
Signal ground	SG	---	7
Send data	SD	Output	2
Receive data	RD	Input	3
Send request	RS	Output	4
Send enable	CS	Input	5
Data set ready	DR	Input	6
Data terminal ready	ER	Output	20
Not used	NC	---	1, 8 to 19, 21 to 25

Electrical characteristics: Conforming to EIA RS-232C  
Synchronization clock: Internal

RS-422 and RS-485

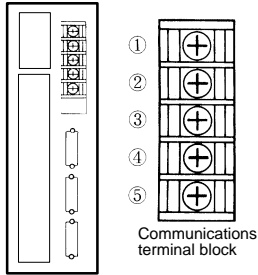

RS-422

Terminal	Signal name	Symbol	Signal direction
1	Receive data B	RDB	Input
2	Receive data A	RDA	Input
3	Signal ground	SG	---
4	Send data B	SDB	Output
5	Send data A	SDA	Output

Electrical characteristics: Conforming to EIA RS-422  
 Synchronization clock: Internal  
 Maximum E5ZE Units connectable: 16 (excluding host system)  
 Transmission length: 500 m max. in total

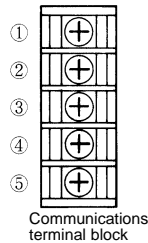

RS-485

Terminal	Signal name	Symbol	Signal direction
1	Not used	---	---
2	Not used	---	---
3	Signal ground	SG	---
4	Terminal B (+)	B	I/O
5	Terminal A (-)	A	I/O

Electrical characteristics: Conforming to EIA RS-485  
 Synchronization clock: Internal  
 Maximum E5ZE Units connectable: 16 (excluding host system)  
 Transmission length: 500 m max. in total

Communications Switch Settings

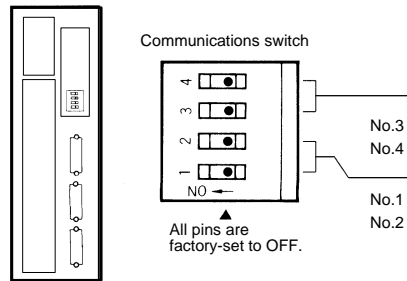

Setting	RS-422	RS-485
Termination resistance	Yes ON ON	OFF ON
	No OFF OFF	OFF OFF
RS-422 ↔ RS-485	OFF OFF DTS-4 NO ←	ON ON DTS-4 NO ←

■ DISPLAY UNIT E5ZD-SDL

External Connection

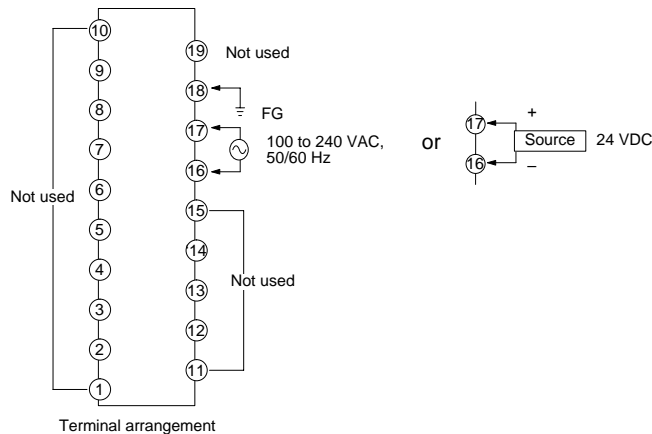

**E5ZD-SDL1****Electrical Characteristics**

Conforming to EIA RS-232C

**Connecting Signals**

Signal name	Symbol	Signal direction	D-sub connector pin number
Field ground	FG	---	1
Signal ground	SG	---	7
Send data	SD	Output	2
Receive data	RD	Input	3
Request send	RS	Output	4
Send enable	CS	Input	5
Data set ready	DR	Input	6
Data terminal ready	ER	Output	20

**Connection**

Only a single E5ZD-SDL can be connected via RS-232C.

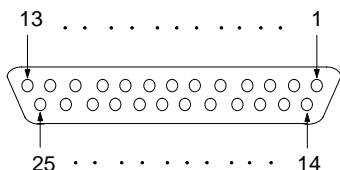
**RS-232C Pin Connection****E5ZD-SDL2-X****Electrical Characteristics**

Conforming to EIA RS-422

**Connecting Signals**

Signal name	Symbol	Signal direction	Terminal block pin number
Send data A	SDA	Output	21
Send data B	SDB	Output	20
Receive data A	RDA	Input	23
Receive data B	RDB	Input	24
Signal ground	SG	---	22
Field ground	FG	---	---

**E5ZD-SDL3-X****Electrical Characteristics**

Conforming to EIA RS-485

**Connecting Signals**

Signal name	Symbol	Signal direction	Terminal block pin number
Terminal A	–	Input/Output	21, 23
Terminal B	+	Input/Output	20, 24
Signal ground	SG	---	22

**Terminal Block**

The size of each screw is M3.

# Precautions

## ■ PLACEMENT OF I/O UNITS

I/O Units are not mounted on the E5ZE.

Mount the appropriate I/O Units according to the specification of the E5ZE.

The diagram below is the view from the back of component side.

### Type of I/O Units

#### Communication Unit

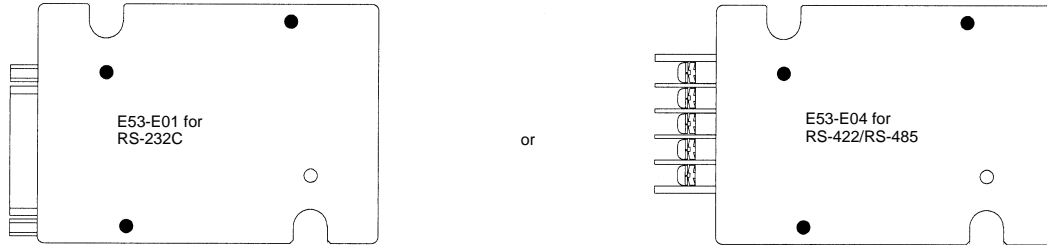

#### CT Input Unit

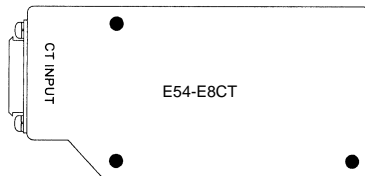

Use this CT input unit in combination with the E53-E8Q voltage output unit.

#### Output Unit

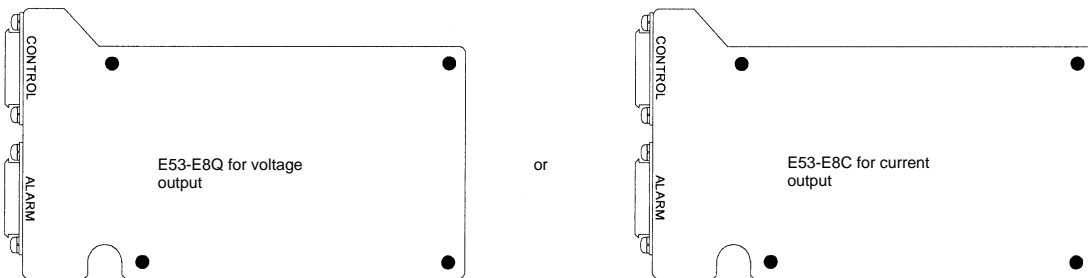

Tighten the screws through the holes marked with a black dot (●) to the mounting studs of the E5ZE.

### Mounting Position of I/O Units

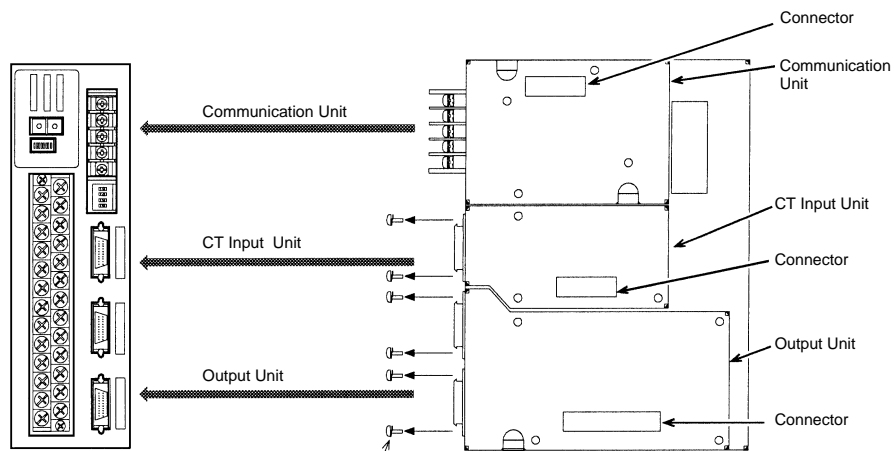

Enclosed model  
E5ZE-8□AAM□B-E

Remove this screw when the Unit is mounted on the model with casing.

## ■ MOUNTING I/O UNITS

Use appropriate Phillips screwdriver for the screws. Use of an inappropriate screwdriver may damage the screws and cause insufficient tightening.

Mount the Units in an environment where anti-static electricity countermeasures have been taken.

Store the removed screws carefully and use them again when required.

1. Remove the connector mounting screws (2 screws each for a connector) from the Units (except for communication unit).
2. Remove the casing mounting screws (6 screws).
3. Remove the casing.
4. When CT Input Unit is not required, do not touch the corresponding screws. To prevent the studs from loosening, use a wrench to fix the studs.
5. Attach the Units in the designated position.  
Connect the Units and the E5ZE connector properly.
6. Attach the Units to the studs with mounting screws with a torque of 0.43 to 0.58 N•m.
7. Attach the connector to the case using the connector mounting screws with a torque of 0.34 to 0.39 N•m.
8. Replace the casing in its original position using six casing mounting screws.

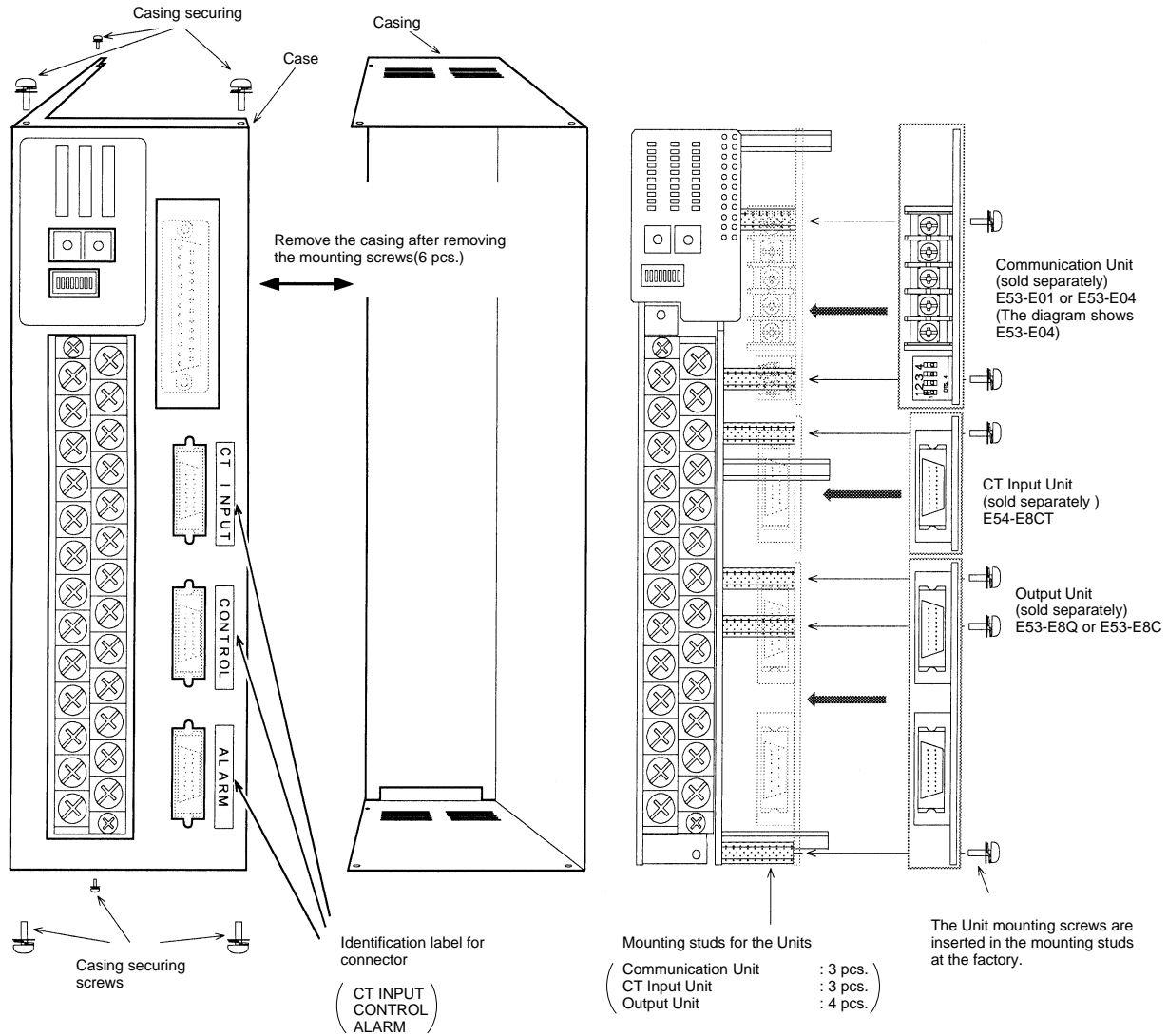

## ■ MOUNTING THE CONTROLLERS

### E5ZE-8□AAM□B-E (Enclosed Type)

#### Side-by-side, Close Mounting

Saves space and improves wiring efficiency.

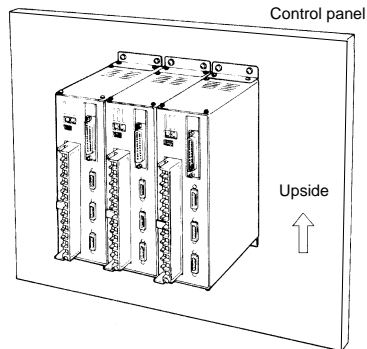

#### Wall Mounting

Can be mounted to places with limited depth.

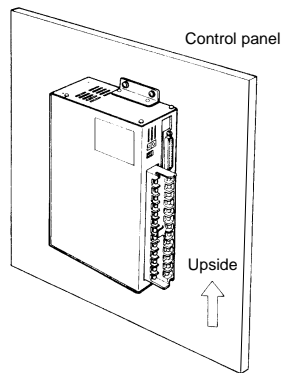

#### General Mounting Precautions

The side of the E5ZE with the terminal block and connectors must not face up, otherwise operating errors may result.

Prepare four M4 screws to mount the E5ZE to control panels. Use flat washers and spring washers with screws to mount the E5ZE to control panels so that the screws will not loosen.

The mounting brackets must be attached to the E5ZE with the four M3 x 6 screws provided with the E5ZE and each of the screws should be tightened to a torque of 0.43 to 0.58 N • m, or 4.4 to 5.9 kgf • cm.

Do not mount as shown in the following diagram.

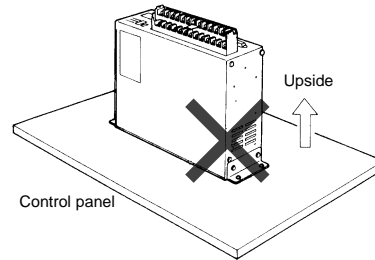

## ■ WIRING FOR CONFORMANCE TO THE EMC DIRECTIVES

### Thermocouple Input Model

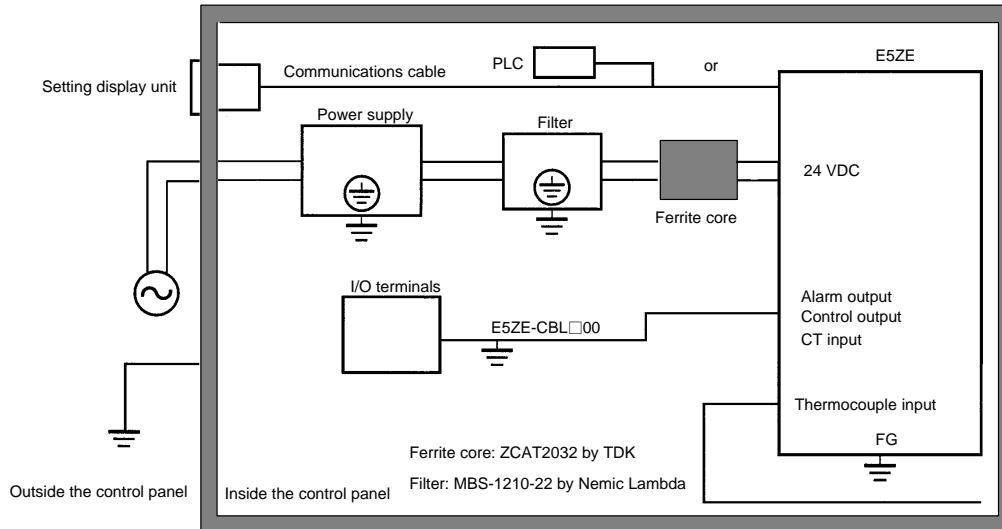

### Platinum Resistance Thermometer Input Model

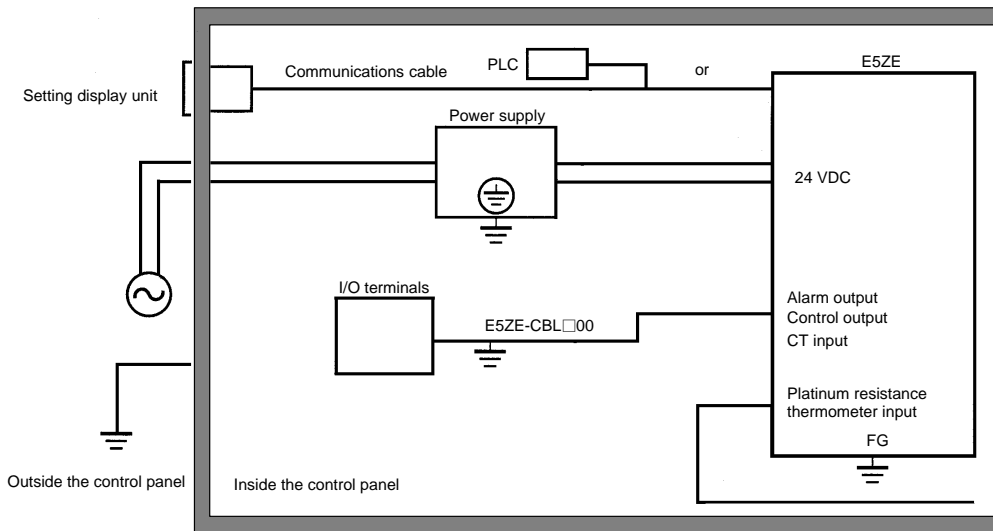

- Note: 1. Place the power supply, filter, input sensor, I/O terminals, and communications cable inside the control panel when wiring them.  
 2. If the communications cable between devices extends outside the control panel, satisfy the following conditions when wiring them.
- Use shielded cables for communications cables and ground to the FG.
  - Insert at least five ferrite cores close to the E5ZE.



---

**OMRON**®  
**OMRON ELECTRONICS, INC.**  
One East Commerce Drive  
Schaumburg, IL 60173  
**1-800-55-OMRON**

**OMRON CANADA, INC.**  
885 Milner Avenue  
Scarborough, Ontario M1B 5V8  
**416-286-6465**

Компания «Океан Электроники» предлагает заключение долгосрочных отношений при поставках импортных электронных компонентов на взаимовыгодных условиях!

Наши преимущества:

- Поставка оригинальных импортных электронных компонентов напрямую с производств Америки, Европы и Азии, а так же с крупнейших складов мира;
- Широкая линейка поставок активных и пассивных импортных электронных компонентов (более 30 млн. наименований);
- Поставка сложных, дефицитных, либо снятых с производства позиций;
- Оперативные сроки поставки под заказ (от 5 рабочих дней);
- Экспресс доставка в любую точку России;
- Помощь Конструкторского Отдела и консультации квалифицированных инженеров;
- Техническая поддержка проекта, помощь в подборе аналогов, поставка прототипов;
- Поставка электронных компонентов под контролем ВП;
- Система менеджмента качества сертифицирована по Международному стандарту ISO 9001;
- При необходимости вся продукция военного и аэрокосмического назначения проходит испытания и сертификацию в лаборатории (по согласованию с заказчиком);
- Поставка специализированных компонентов военного и аэрокосмического уровня качества (Xilinx, Altera, Analog Devices, Intersil, Interpoint, Microsemi, Actel, Aeroflex, Peregrine, VPT, Syfer, Eurofarad, Texas Instruments, MS Kennedy, Miteq, Cobham, E2V, MA-COM, Hittite, Mini-Circuits, General Dynamics и др.);

Компания «Океан Электроники» является официальным дистрибьютором и эксклюзивным представителем в России одного из крупнейших производителей разъемов военного и аэрокосмического назначения «JONHON», а так же официальным дистрибьютором и эксклюзивным представителем в России производителя высокотехнологичных и надежных решений для передачи СВЧ сигналов «FORSTAR».



## JONHON

«JONHON» (основан в 1970 г.)

Разъемы специального, военного и аэрокосмического назначения:

(Применяются в военной, авиационной, аэрокосмической, морской, железнодорожной, горно- и нефтедобывающей отраслях промышленности)

«FORSTAR» (основан в 1998 г.)

ВЧ соединители, коаксиальные кабели,  
кабельные сборки и микроволновые компоненты:

(Применяются в телекоммуникациях гражданского и специального назначения, в средствах связи, РЛС, а так же военной, авиационной и аэрокосмической отраслях промышленности).



Телефон: 8 (812) 309-75-97 (многоканальный)

Факс: 8 (812) 320-03-32

Электронная почта: [ocean@oceanchips.ru](mailto:ocean@oceanchips.ru)

Web: <http://oceanchips.ru/>

Адрес: 198099, г. Санкт-Петербург, ул. Калинина, д. 2, корп. 4, лит. А