

# NCP5104

## High Voltage, Half Bridge Driver

The NCP5104 is a High Voltage Power gate Driver providing two outputs for direct drive of 2 N-channel power MOSFETs or IGBTs arranged in a half-bridge configuration. It uses the bootstrap technique to insure a proper drive of the High-side power switch.

### Features

- High Voltage Range: up to 600 V
- dV/dt Immunity  $\pm 50$  V/nsec
- Gate Drive Supply Range from 10 V to 20 V
- High and Low Drive Outputs
- Output Source / Sink Current Capability 250 mA / 500 mA
- 3.3 V and 5 V Input Logic Compatible
- Up to  $V_{CC}$  Swing on Input Pins
- Extended Allowable Negative Bridge Pin Voltage Swing to  $-10$  V for Signal Propagation
- Matched Propagation Delays between Both Channels
- 1 Input with Internal Fixed Dead Time (520 ns)
- Under  $V_{CC}$  LockOut (UVLO) for Both Channels
- Pin to Pin Compatible with Industry Standards
- These are Pb-Free Devices

### Typical Applications

- Half-Bridge Power Converters



**ON Semiconductor®**

<http://onsemi.com>



SOIC-8  
D SUFFIX  
CASE 751

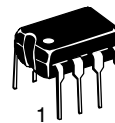

PDIP-8  
P SUFFIX  
CASE 626

### MARKING DIAGRAMS

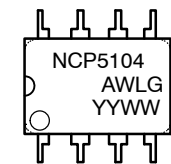
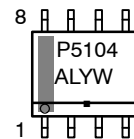

NCP5104 = Specific Device Code  
A = Assembly Location  
L or WL = Wafer Lot  
Y or YY = Year  
W or WW = Work Week  
G or ■ = Pb-Free Package

### PINOUT INFORMATION

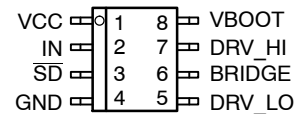

8 Pin Package

### ORDERING INFORMATION

Device	Package	Shipping†
NCP5104PG	PDIP-8 (Pb-Free)	50 Units / Rail
NCP5104DR2G	SOIC-8 (Pb-Free)	2500 / Tape & Reel

† For information on tape and reel specifications, including part orientation and tape sizes, please refer to our Tape and Reel Packaging Specification Brochure, BRD8011/D.

# NCP5104

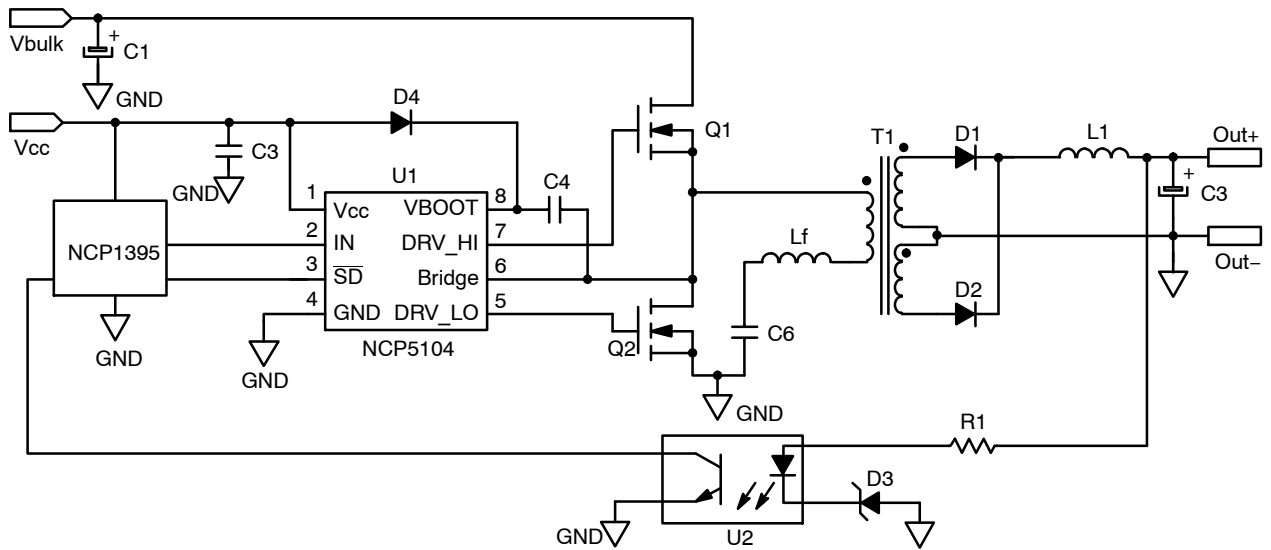

Figure 1. Typical Application Resonant Converter (LLC type)

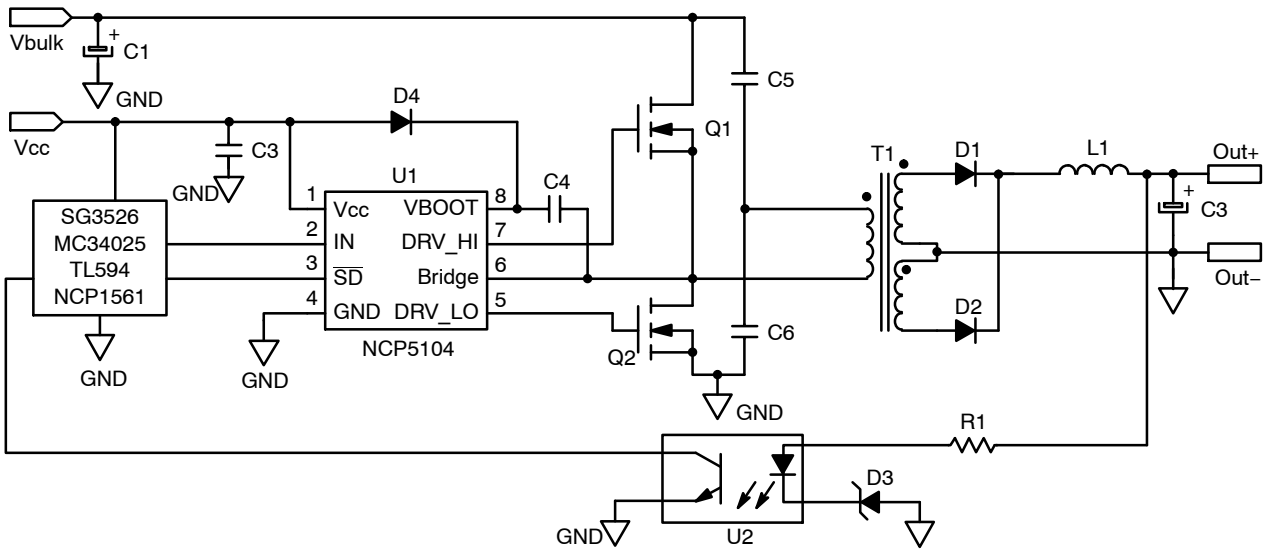

Figure 2. Typical Application Half Bridge Converter

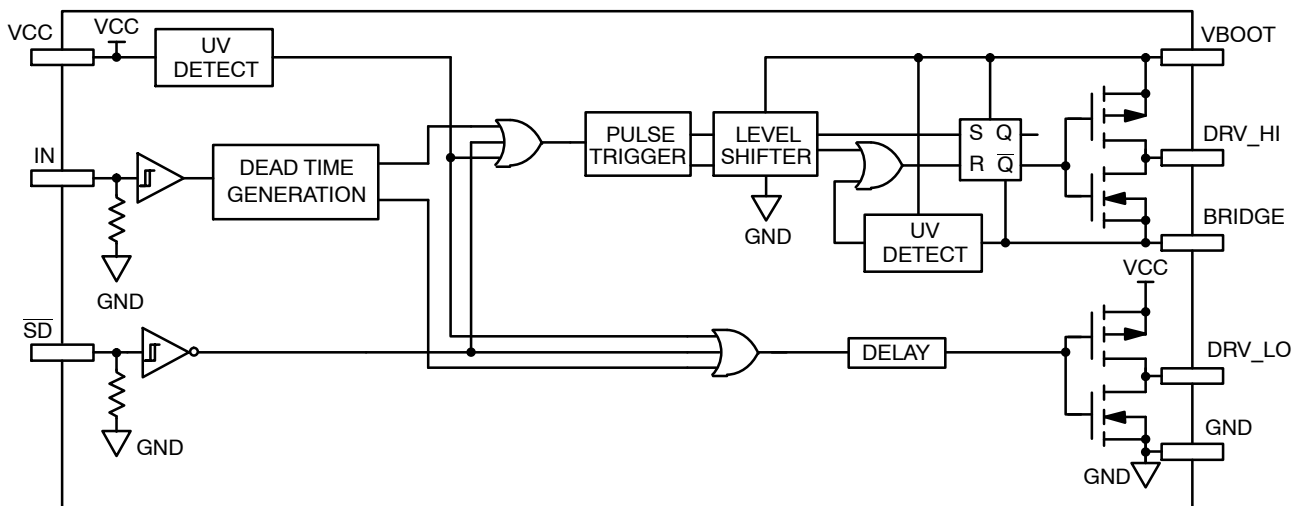

Figure 3. Detailed Block Diagram

# NCP5104

## PIN DESCRIPTION

Pin Name	Description
V <sub>CC</sub>	Low Side and Main Power Supply
IN	Logic Input
$\overline{SD}$	Logic Input for Shutdown
GND	Ground
DRV_LO	Low Side Gate Drive Output
V <sub>BOOT</sub>	Bootstrap Power Supply
DRV_HI	High Side Gate Drive Output
BRIDGE	Bootstrap Return or High Side Floating Supply Return

## MAXIMUM RATINGS

Rating	Symbol	Value	Unit
V <sub>CC</sub>	Main power supply voltage	-0.3 to 20	V
V <sub>CC_transient</sub>	Main transient power supply voltage: I <sub>V<sub>CC_max</sub></sub> = 5 mA during 10 ms	23	V
V <sub>BOOT</sub>	VHV: High Voltage BOOT Pin	-1 to 620	V
V <sub>BRIDGE</sub>	VHV: High Voltage BRIDGE pin	-1 to 600	V
V <sub>BRIDGE</sub>	Allowable Negative Bridge Pin Voltage for IN Signal Propagation to DRV_LO	-10	V
V <sub>BOOT-V<sub>BRIDGE</sub></sub>	VHV: Floating supply voltage	-0.3 to 20	V
V <sub>DRV_HI</sub>	VHV: High side output voltage	V <sub>BRIDGE</sub> - 0.3 to V <sub>BOOT</sub> + 0.3	V
V <sub>DRV_LO</sub>	Low side output voltage	-0.3 to V <sub>CC</sub> + 0.3	V
dV <sub>BRIDGE</sub> /dt	Allowable output slew rate	50	V/ns
V <sub>IN</sub> , V <sub>SD</sub>	Inputs IN & SD	-1.0 to V <sub>CC</sub> + 0.3	V
	ESD Capability: - HBM model (all pins except pins 6-7-8 in 8) - Machine model (all pins except pins 6-7-8)	2 200	kV V
	Latch up capability per JEDEC JESD78		
R <sub>θJA</sub>	Power dissipation and Thermal characteristics PDIP-8: Thermal Resistance, Junction-to-Air SO-8: Thermal Resistance, Junction-to-Air	100 178	°C/W
T <sub>ST</sub>	Storage Temperature Range	-55 to +150	°C
T <sub>J_max</sub>	Maximum Operating Junction Temperature	+150	°C

Stresses exceeding Maximum Ratings may damage the device. Maximum Ratings are stress ratings only. Functional operation above the Recommended Operating Conditions is not implied. Extended exposure to stresses above the Recommended Operating Conditions may affect device reliability.

# NCP5104

**ELECTRICAL CHARACTERISTIC** ( $V_{CC} = V_{boot} = 15\text{ V}$ ,  $V_{GND} = V_{bridge}$ ,  $-40^{\circ}\text{C} < T_J < 125^{\circ}\text{C}$ , Outputs loaded with 1 nF)

Rating	Symbol	$T_J -40^{\circ}\text{C to }125^{\circ}\text{C}$			Units
		Min	Typ	Max	

## OUTPUT SECTION

Output high short circuit pulsed current $V_{DRV} = 0\text{ V}$ , $PW \leq 10\ \mu\text{s}$ (Note 1)	$I_{DRVsource}$	-	250	-	mA
Output low short circuit pulsed current $V_{DRV} = V_{CC}$ , $PW \leq 10\ \mu\text{s}$ (Note 1)	$I_{DRVsink}$	-	500	-	mA
Output resistor (Typical value @ $25^{\circ}\text{C}$ ) Source	$R_{OH}$	-	30	60	$\Omega$
Output resistor (Typical value @ $25^{\circ}\text{C}$ ) Sink	$R_{OL}$	-	10	20	$\Omega$
High level output voltage, $V_{BIAS} - V_{DRV\_XX}$ @ $I_{DRV\_XX} = 20\text{ mA}$	$V_{DRV\_H}$	-	0.7	1.6	V
Low level output voltage $V_{DRV\_XX}$ @ $I_{DRV\_XX} = 20\text{ mA}$	$V_{DRV\_L}$	-	0.2	0.6	V

## DYNAMIC OUTPUT SECTION

Turn-on propagation delay ( $V_{bridge} = 0\text{ V}$ ) (Note 2)	$t_{ON}$	-	620	800	ns
Turn-off propagation delay ( $V_{bridge} = 0\text{ V}$ or $50\text{ V}$ ) (Note 3)	$t_{OFF}$	-	100	170	ns
Shutdown propagation delay, when Shutdown is enabled	$t_{sd\_en}$	-	100	170	ns
Shutdown propagation delay, when Shutdown is disabled	$t_{sd\_dis}$	-	620	800	ns
Output voltage rise time (from 10% to 90% @ $V_{CC} = 15\text{ V}$ ) with 1 nF load	$t_r$	-	85	160	ns
Output voltage fall time (from 90% to 10% @ $V_{CC} = 15\text{ V}$ ) with 1 nF load	$t_f$	-	35	75	ns
Propagation delay matching between the High side and the Low side @ $25^{\circ}\text{C}$ (Note 4)	$\Delta t$	-	10	45	ns
Internal fixed dead time (Note 5)	DT	400	520	650	ns

## INPUT SECTION

Low level input voltage threshold	$V_{IN}$	-	-	0.8	V
Input pull-down resistor ( $V_{IN} < 0.5\text{ V}$ )	$R_{IN}$	-	200	-	k $\Omega$
High level input voltage threshold	$V_{IN}$	2.3	-	-	V
Logic "1" input bias current @ $V_{IN} = 5\text{ V}$ @ $25^{\circ}\text{C}$	$I_{IN+}$	-	5	25	$\mu\text{A}$
Logic "0" input bias current @ $V_{IN} = 0\text{ V}$ @ $25^{\circ}\text{C}$	$I_{IN-}$	-	-	2.0	$\mu\text{A}$

## SUPPLY SECTION

Vcc UV Start-up voltage threshold	$V_{cc\_stup}$	8.0	8.9	9.8	V
Vcc UV Shut-down voltage threshold	$V_{cc\_shtdwn}$	7.3	8.2	9.0	V
Hysteresis on Vcc	$V_{cc\_hyst}$	0.3	0.7	-	V
Vboot Start-up voltage threshold reference to bridge pin ( $V_{boot\_stup} = V_{boot} - V_{bridge}$ )	$V_{boot\_stup}$	8.0	8.9	9.8	V
Vboot UV Shut-down voltage threshold	$V_{boot\_shtdwn}$	7.3	8.2	9.0	V
Hysteresis on Vboot	$V_{boot\_shtdwn}$	0.3	0.7	-	V
Leakage current on high voltage pins to GND ( $V_{BOOT} = V_{BRIDGE} = DRV\_HI = 600\text{ V}$ )	$I_{HV\_LEAK}$	-	5	40	$\mu\text{A}$
Consumption in active mode ( $V_{cc} = V_{boot}$ , $f_{sw} = 100\text{ kHz}$ and 1 nF load on both driver outputs)	ICC1	-	4	5	mA
Consumption in inhibition mode ( $V_{cc} = V_{boot}$ )	ICC2	-	250	400	$\mu\text{A}$
Vcc current consumption in inhibition mode	ICC3	-	200	-	$\mu\text{A}$
Vboot current consumption in inhibition mode	ICC4	-	50	-	$\mu\text{A}$

1. Parameter guaranteed by design.
2.  $T_{ON} = T_{OFF} + DT$
3. Turn-off propagation delay @  $V_{bridge} = 600\text{ V}$  is guaranteed by design.
4. See characterization curve for  $\Delta t$  parameters variation on the full range temperature.
5. Timing diagram definition see: Figure 4, Figure 5 and Figure 6.

# NCP5104

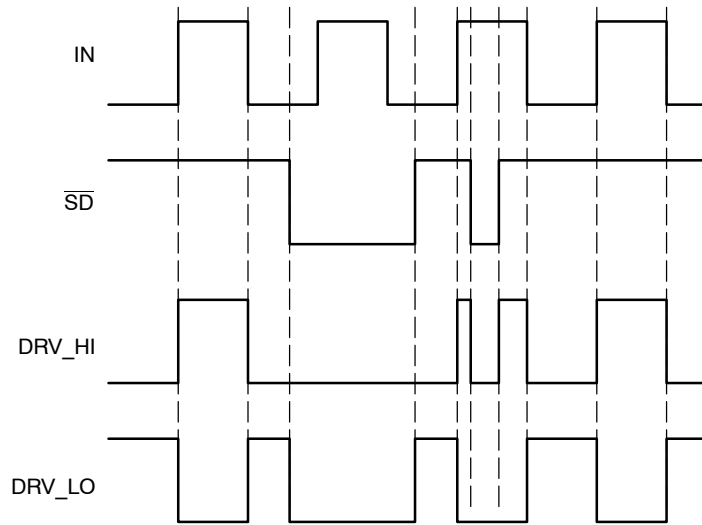

Figure 4. Input/Output Timing Diagram

Note: DRV\_HI output is in phase with the input

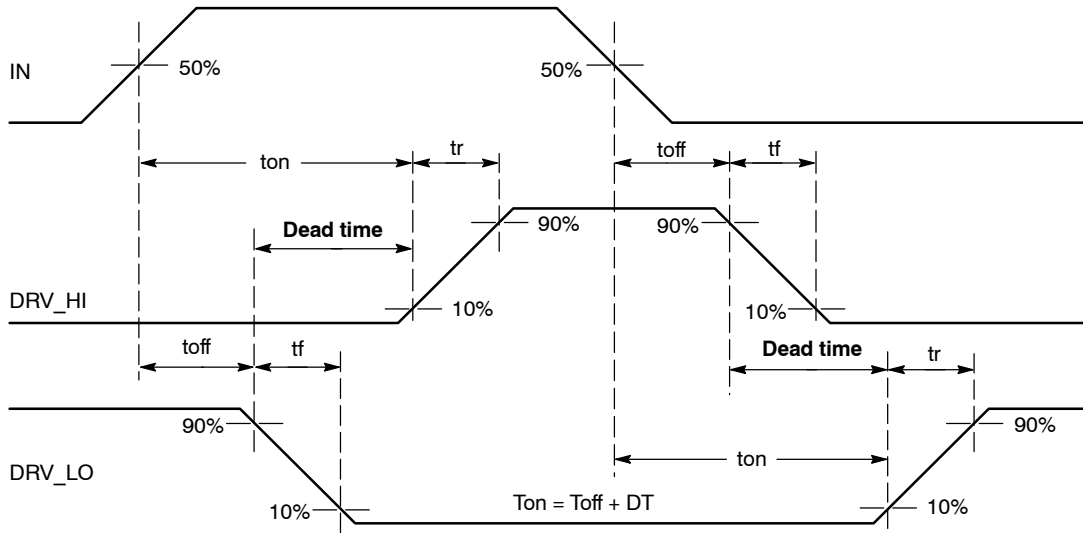
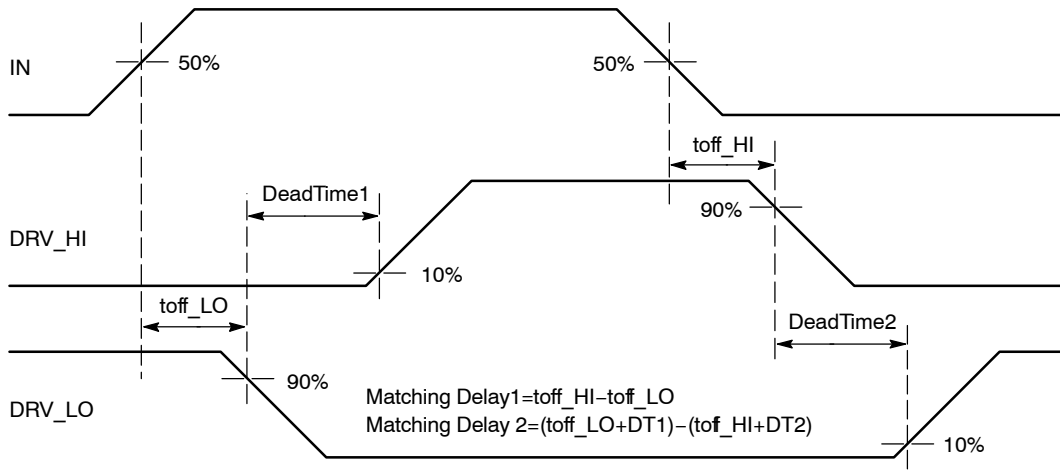
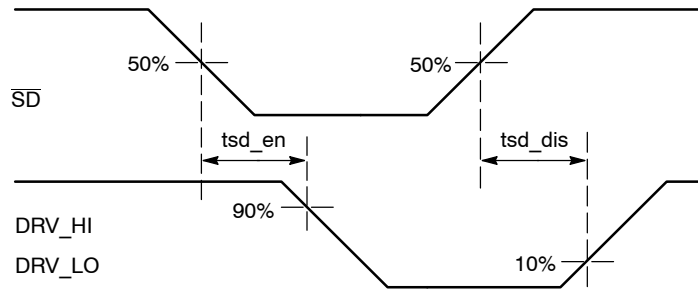

Figure 5. Timing Definitions

# NCP5104



**Figure 6. Matching Propagation Delay Definition**



**Figure 7. Shutdown Waveform Definition**

CHARACTERIZATION CURVES

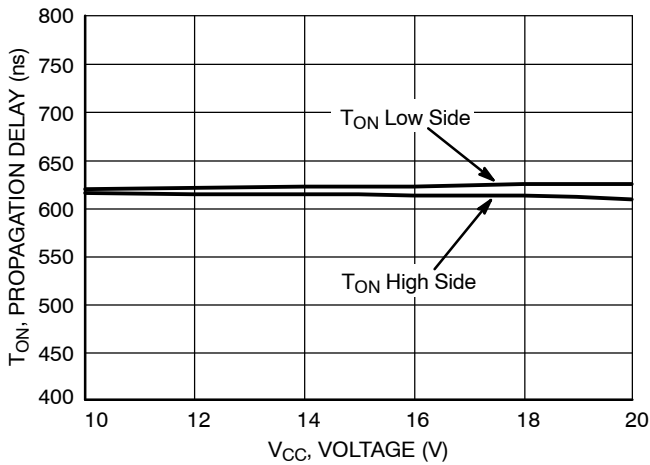

Figure 8. Turn ON Propagation Delay vs. Supply Voltage ( $V_{CC} = V_{BOOT}$ )

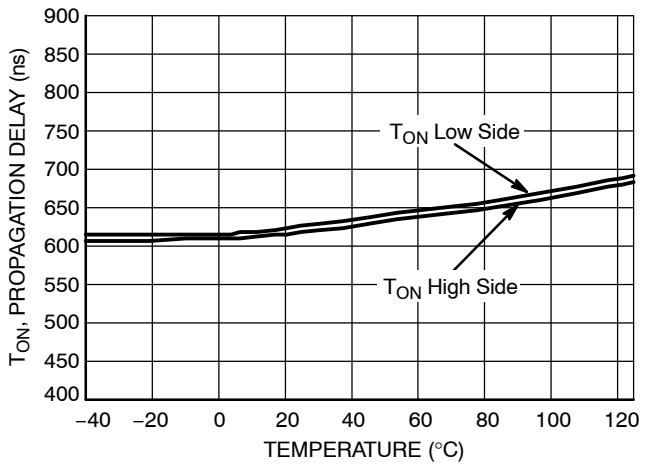

Figure 9. Turn ON Propagation Delay vs. Temperature

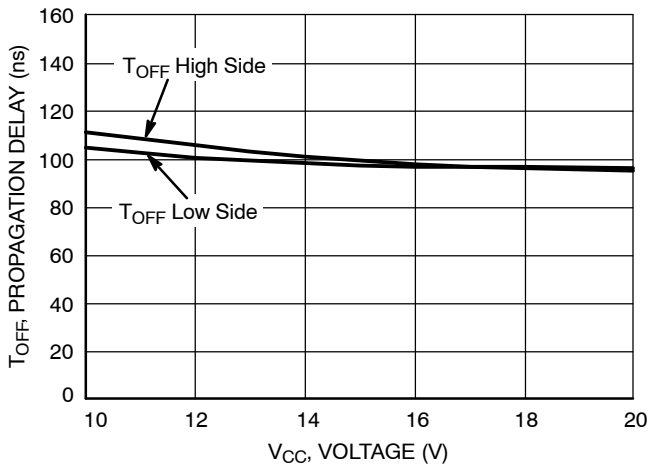

Figure 10. Turn OFF Propagation Delay vs. Supply Voltage ( $V_{CC} = V_{BOOT}$ )

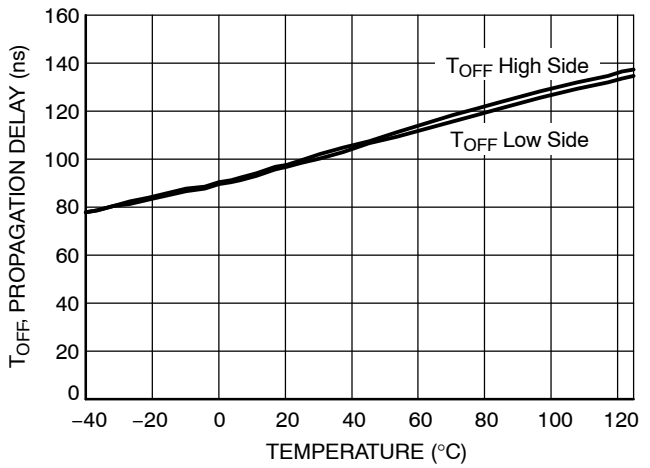

Figure 11. Turn OFF Propagation Delay vs. Temperature

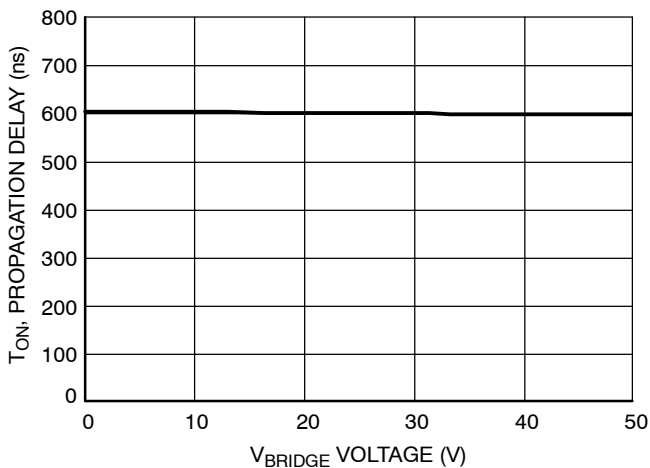

Figure 12. High Side Turn ON Propagation Delay vs.  $V_{BRIDGE}$  Voltage ( $V_{CC} = V_{BOOT}$ )

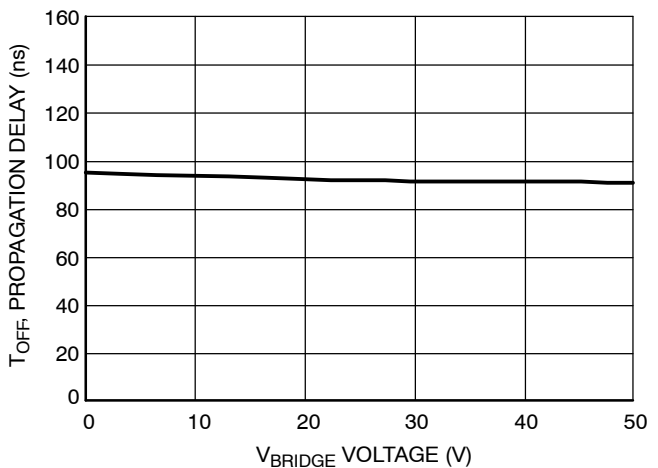

Figure 13. High Side Turn OFF Propagation Delay vs.  $V_{BRIDGE}$  Voltage ( $V_{CC} = V_{BOOT}$ )

CHARACTERIZATION CURVES

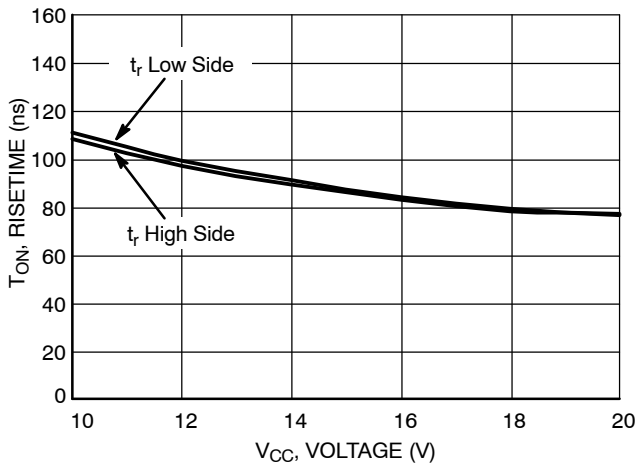

Figure 14. Turn ON Risetime vs. Supply Voltage ( $V_{CC} = V_{BOOT}$ )

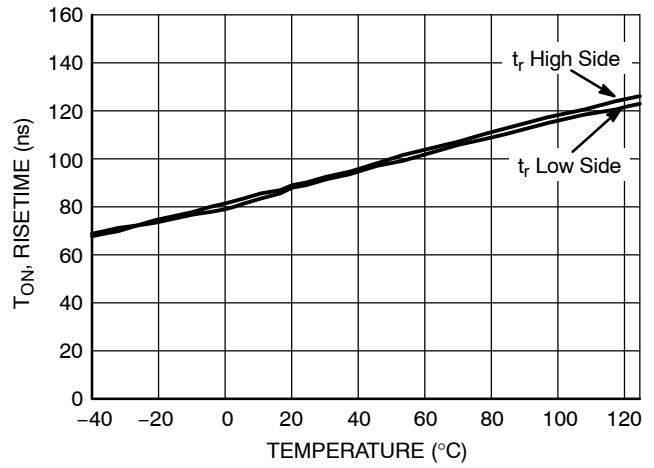

Figure 15. Turn ON Risetime vs. Temperature

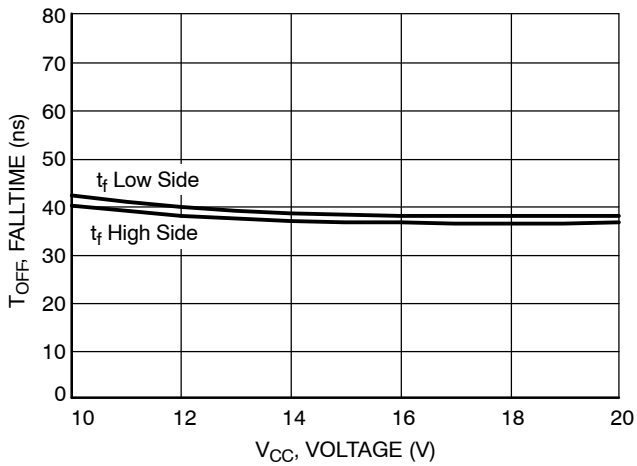

Figure 16. Turn OFF Falltime vs. Supply Voltage ( $V_{CC} = V_{BOOT}$ )

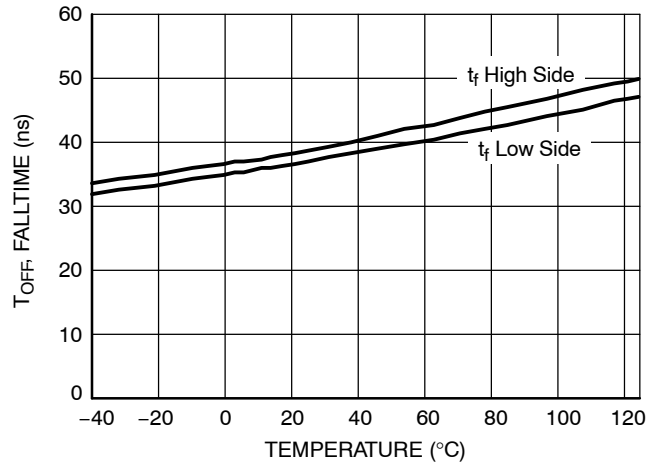

Figure 17. Turn OFF Falltime vs. Temperature

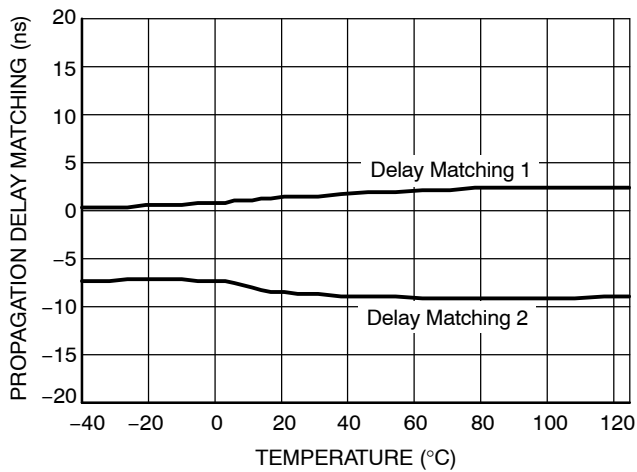

Figure 18. Propagation Delay Matching Between High Side and Low Side Driver vs. Temperature

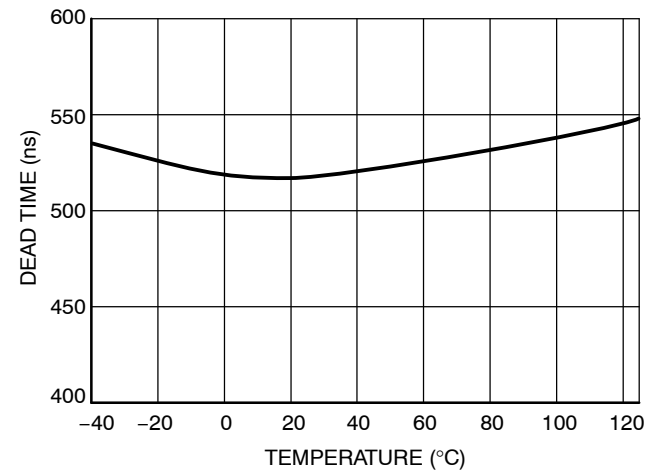

Figure 19. Dead Time vs. Temperature



CHARACTERIZATION CURVES

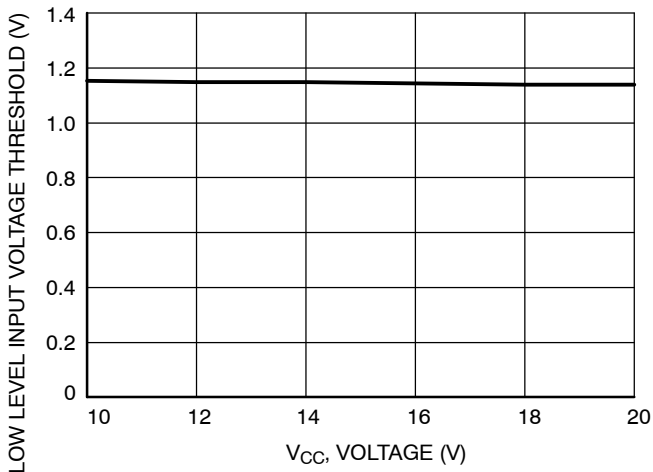

Figure 20. Low Level Input Voltage Threshold vs. Supply Voltage ( $V_{CC} = V_{BOOT}$ )

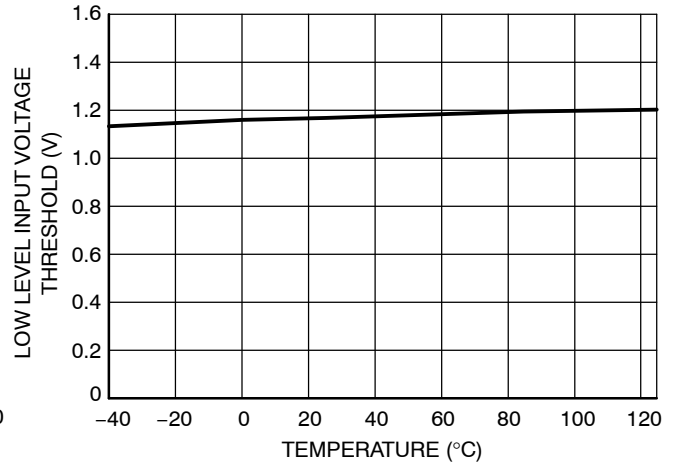

Figure 21. Low Level Input Voltage Threshold vs. Temperature

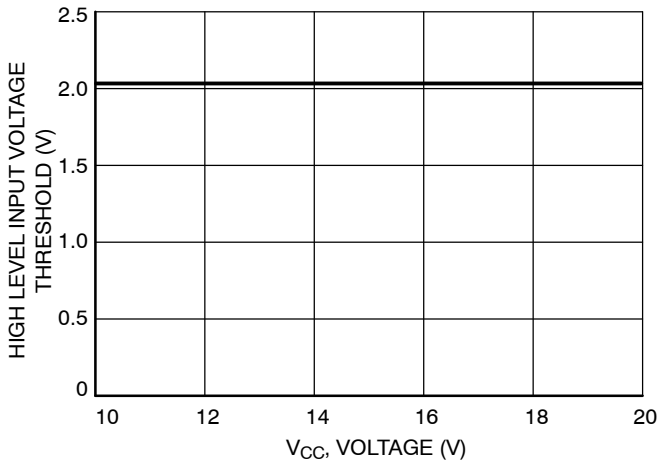

Figure 22. High Level Input Voltage Threshold vs. Supply Voltage ( $V_{CC} = V_{BOOT}$ )

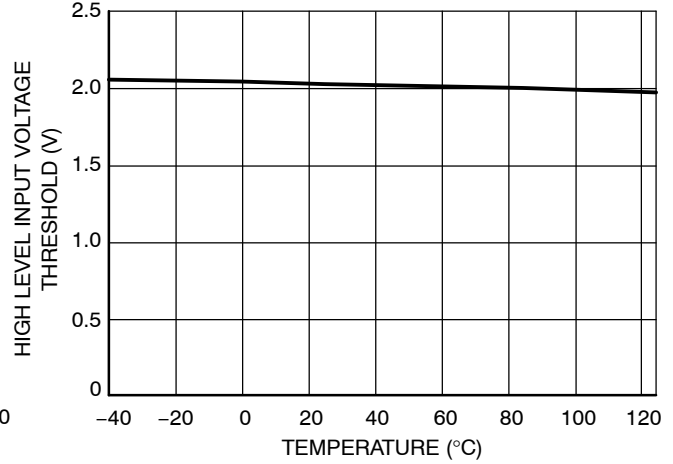

Figure 23. High Level Input Voltage Threshold vs. Temperature

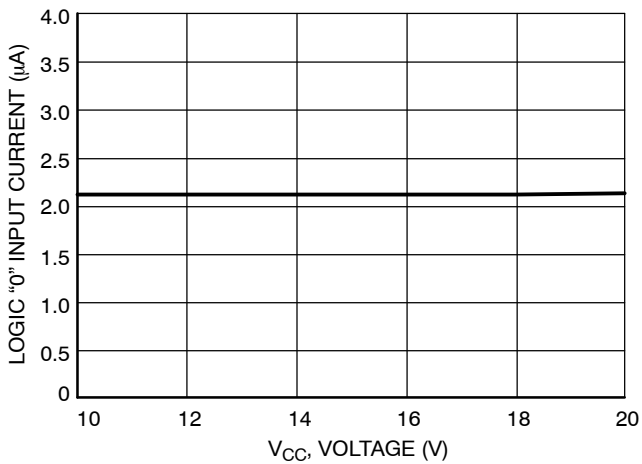

Figure 24. Logic "0" Input Current vs. Supply Voltage ( $V_{CC} = V_{BOOT}$ )

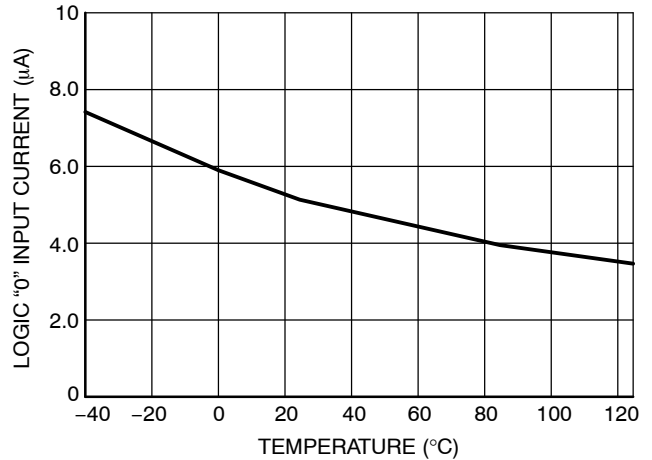

Figure 25. Logic "0" Input Current vs. Temperature

CHARACTERIZATION CURVES

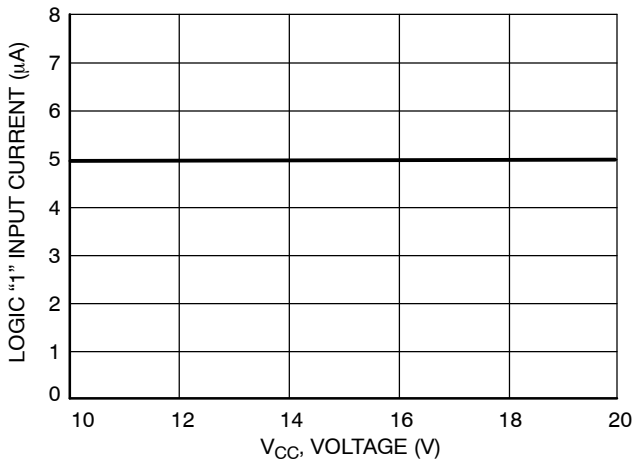

Figure 26. Logic "1" Input Current vs. Supply Voltage ( $V_{CC} = V_{BOOT}$ )

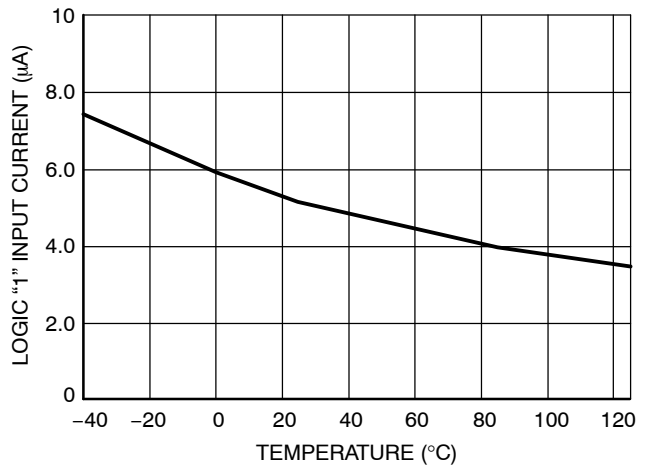

Figure 27. Logic "1" Input Current vs. Temperature

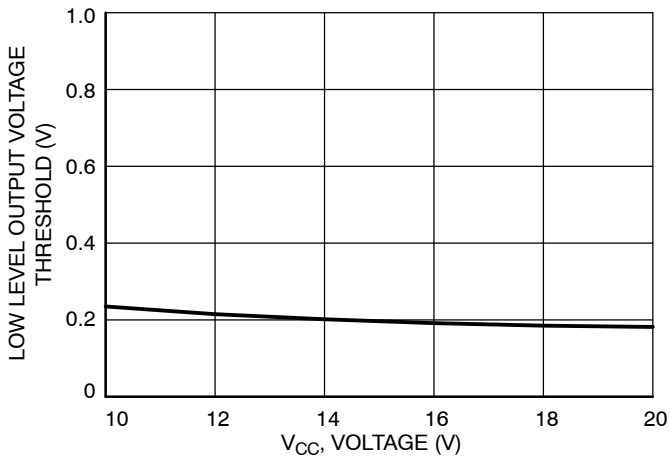

Figure 28. Low Level Output Voltage vs. Supply Voltage ( $V_{CC} = V_{BOOT}$ )

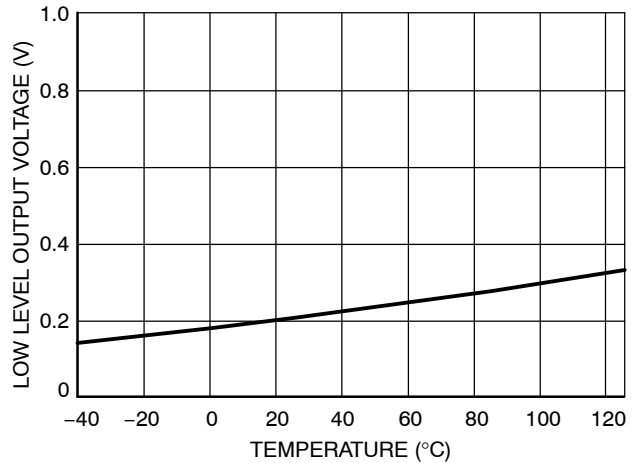

Figure 29. Low Level Output Voltage vs. Temperature

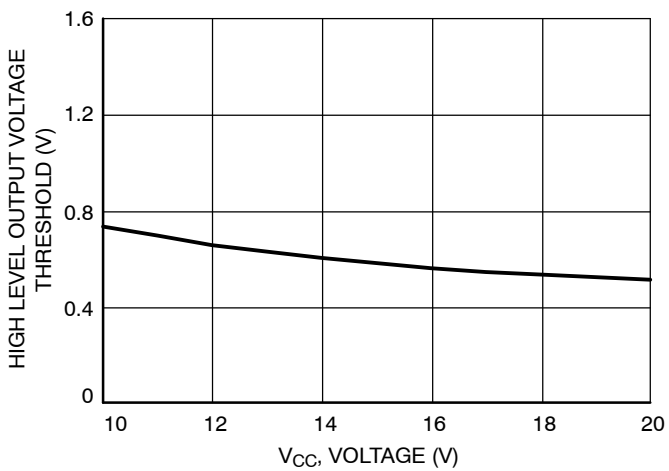

Figure 30. High Level Output Voltage vs. Supply Voltage ( $V_{CC} = V_{BOOT}$ )

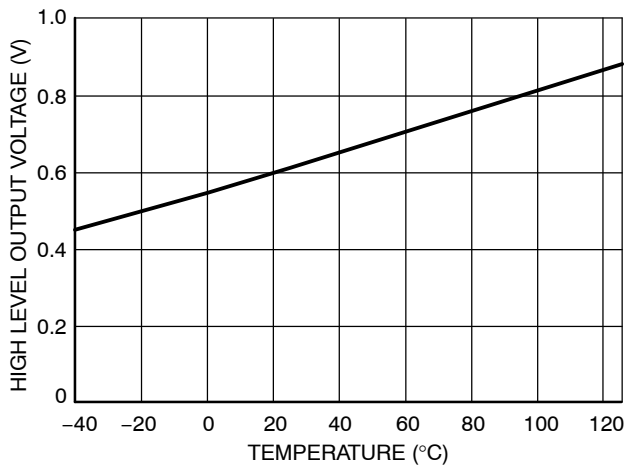

Figure 31. High Level Output Voltage vs. Temperature

CHARACTERIZATION CURVES

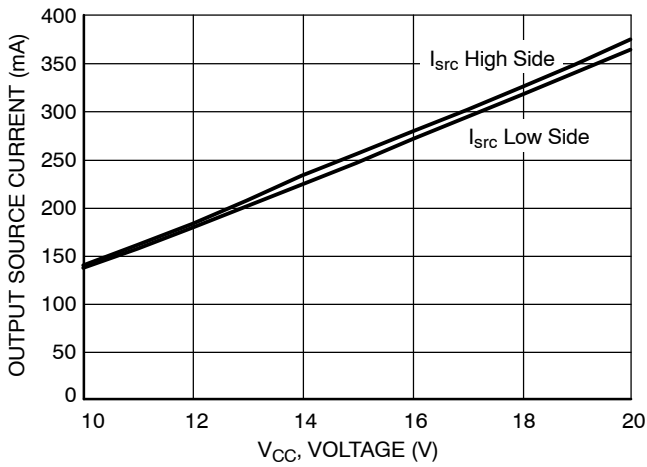

Figure 32. Output Source Current vs. Supply Voltage ( $V_{CC} = V_{BOOT}$ )

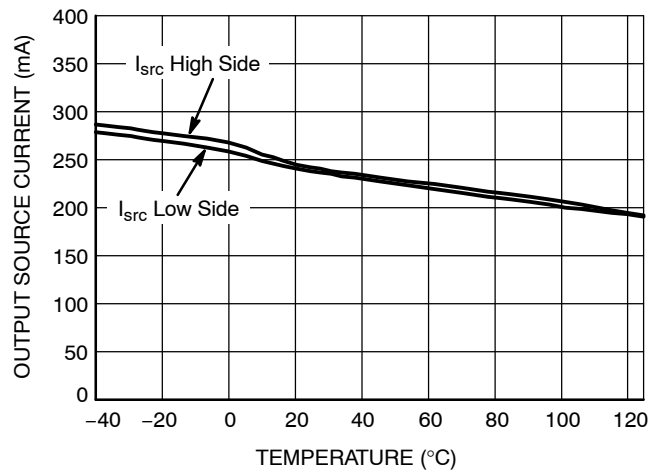

Figure 33. Output Source Current vs. Temperature

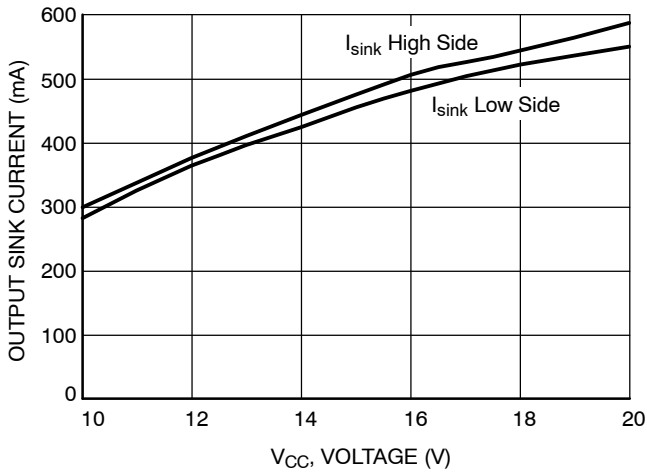

Figure 34. Output Sink Current vs. Supply Voltage ( $V_{CC} = V_{BOOT}$ )

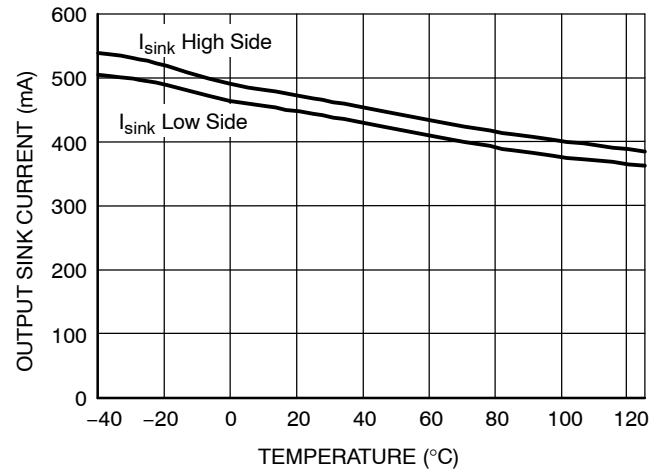

Figure 35. Output Sink Current vs. Temperature

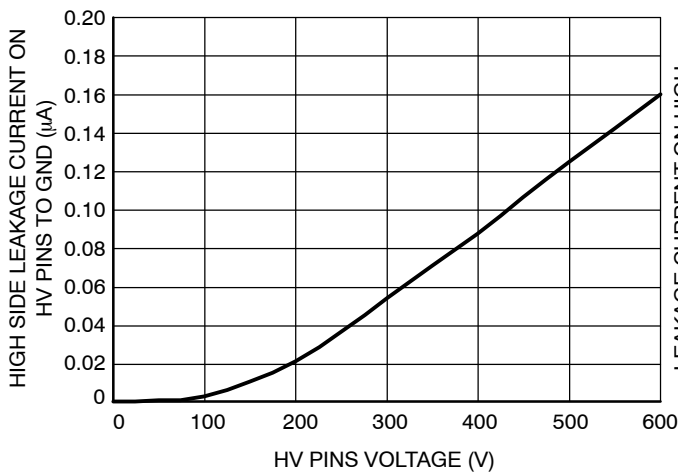

Figure 36. Leakage Current on High Voltage Pins (600 V) to Ground vs.  $V_{BRIDGE}$  Voltage ( $V_{BRIDGE} = V_{BOOT} = V_{DRV\_HI}$ )

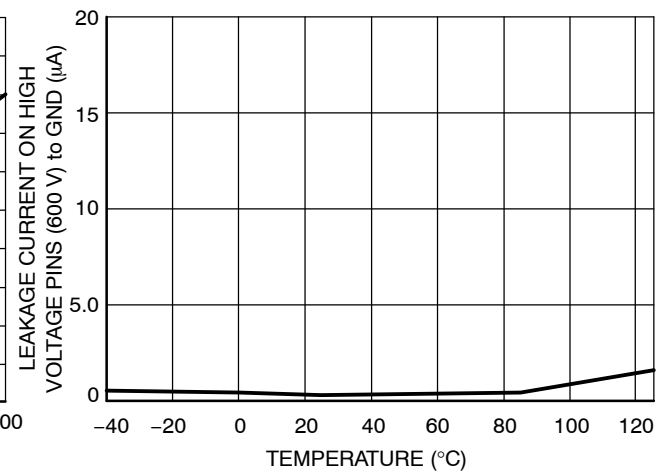

Figure 37. Leakage Current on High Voltage Pins (600 V) to Ground vs. Temperature ( $V_{BRIDGE} = V_{BOOT} = V_{DRV\_HI} = 600$  V)

CHARACTERIZATION CURVES

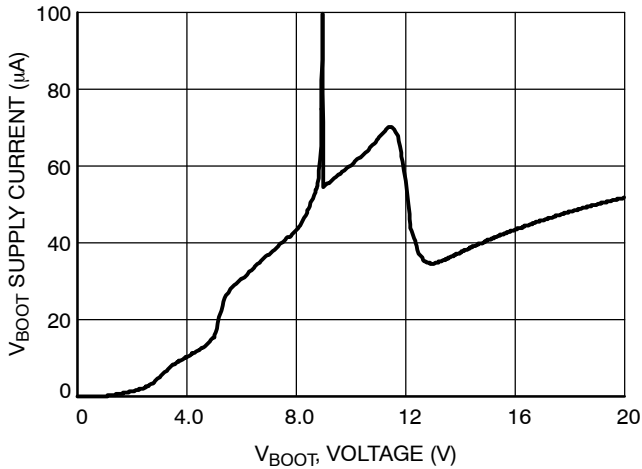

Figure 38.  $V_{BOOT}$  Supply Current vs. Bootstrap Supply Voltage ( $V_{CC} = V_{BOOT}$ )

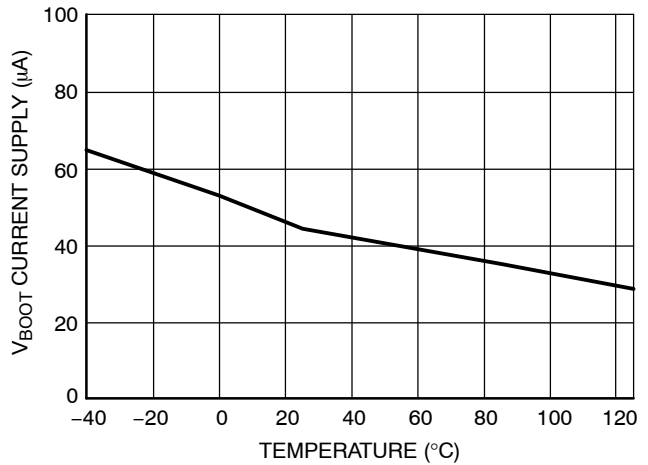

Figure 39.  $V_{BOOT}$  Supply Current vs. Temperature

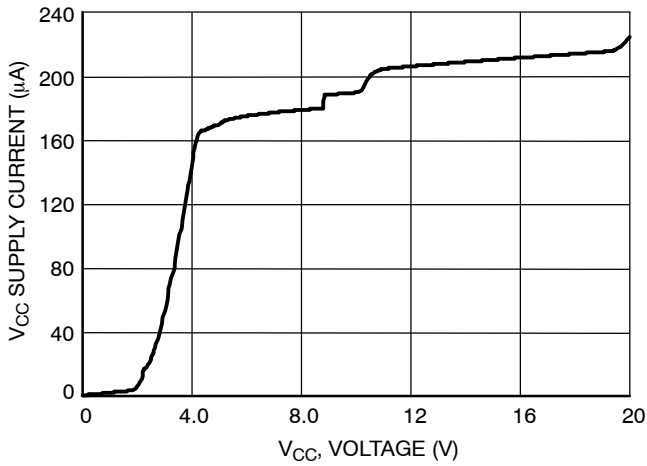

Figure 40.  $V_{CC}$  Supply Current vs.  $V_{CC}$  Supply Voltage ( $V_{CC} = V_{BOOT}$ )

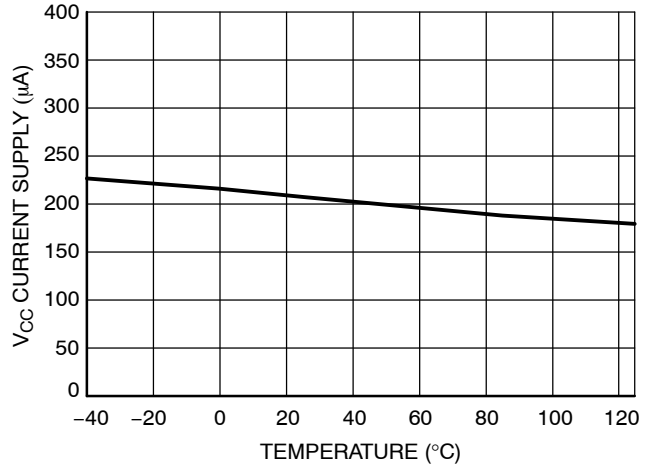

Figure 41.  $V_{CC}$  Supply Current vs. Temperature

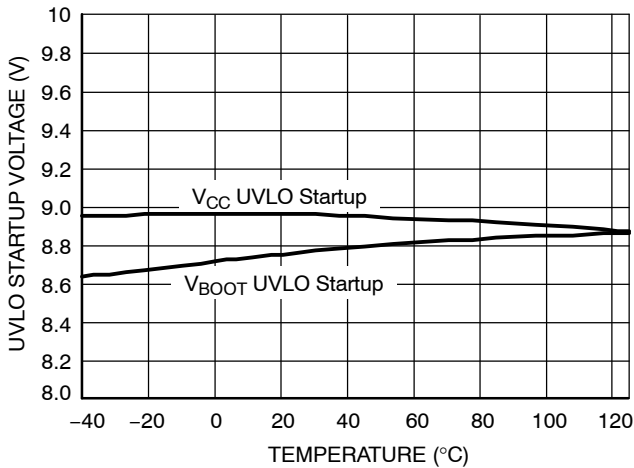

Figure 42. UVLO Startup Voltage vs. Temperature

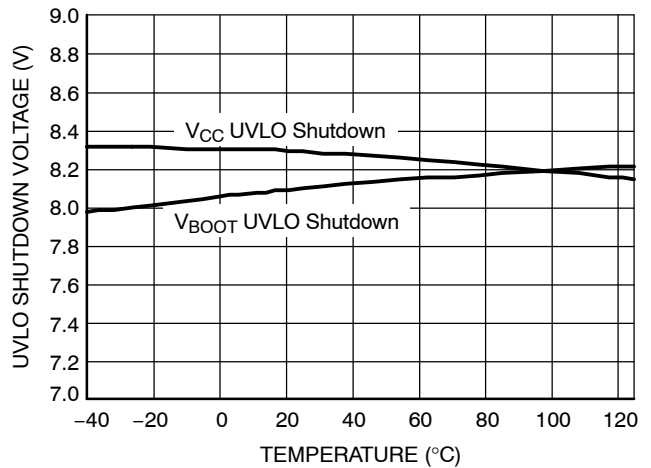
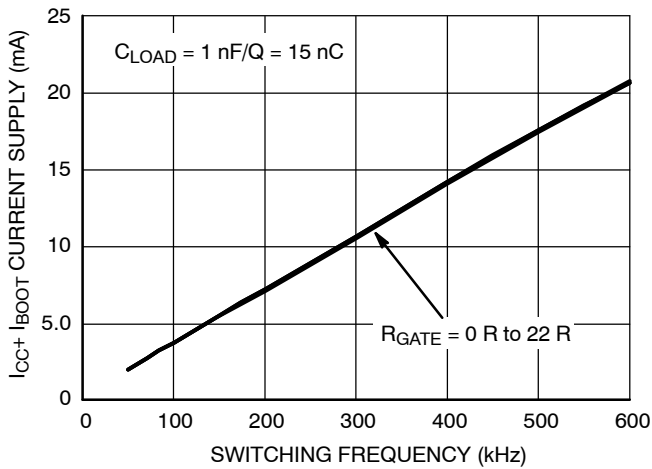
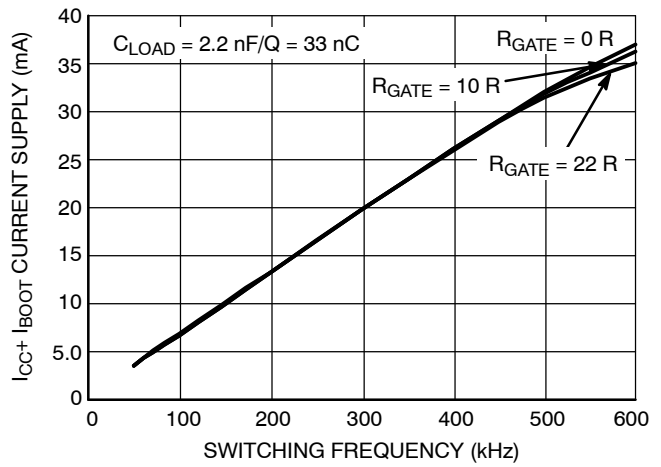

Figure 43. UVLO Shutdown Voltage vs. Temperature

CHARACTERIZATION CURVES



**Figure 44.  $I_{CC1}$  Consumption vs. Switching Frequency with 15 nC Load on Each Driver @  $V_{CC} = 15 \text{ V}$**



**Figure 45.  $I_{CC1}$  Consumption vs. Switching Frequency with 33 nC Load on Each Driver @  $V_{CC} = 15 \text{ V}$**

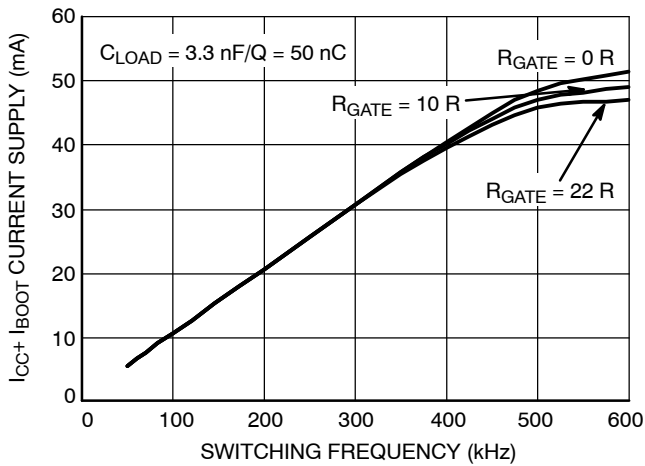

**Figure 46.  $I_{CC1}$  Consumption vs. Switching Frequency with 50 nC Load on Each Driver @  $V_{CC} = 15 \text{ V}$**

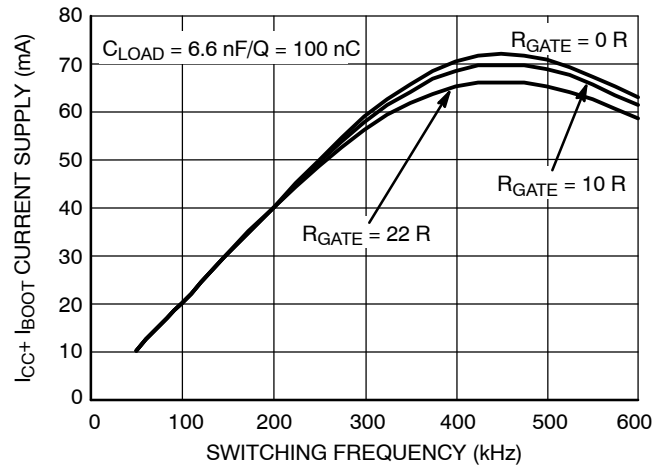
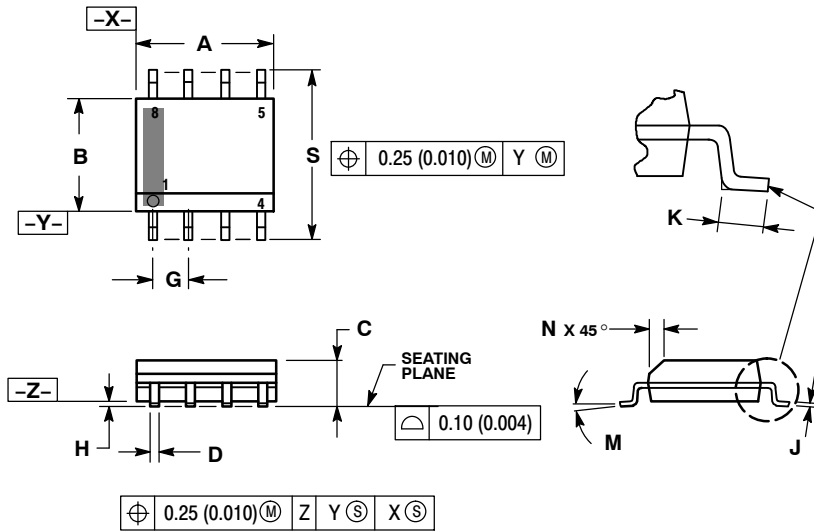

**Figure 47.  $I_{CC1}$  Consumption vs. Switching Frequency with 100 nC Load on Each Driver @  $V_{CC} = 15 \text{ V}$**

# NCP5104

## PACKAGE DIMENSIONS

SOIC-8 NB  
CASE 751-07  
ISSUE AJ



**NOTES:**

1. DIMENSIONING AND TOLERANCING PER ANSI Y14.5M, 1982.
2. CONTROLLING DIMENSION: MILLIMETER.
3. DIMENSION A AND B DO NOT INCLUDE MOLD PROTRUSION.
4. MAXIMUM MOLD PROTRUSION 0.15 (0.006) PER SIDE.
5. DIMENSION D DOES NOT INCLUDE DAMBAR PROTRUSION. ALLOWABLE DAMBAR PROTRUSION SHALL BE 0.127 (0.005) TOTAL IN EXCESS OF THE D DIMENSION AT MAXIMUM MATERIAL CONDITION.
6. 751-01 THRU 751-06 ARE OBSOLETE. NEW STANDARD IS 751-07.

DIM	MILLIMETERS		INCHES	
	MIN	MAX	MIN	MAX
A	4.80	5.00	0.189	0.197
B	3.80	4.00	0.150	0.157
C	1.35	1.75	0.053	0.069
D	0.33	0.51	0.013	0.020
G	1.27 BSC		0.050 BSC	
H	0.10	0.25	0.004	0.010
J	0.19	0.25	0.007	0.010
K	0.40	1.27	0.016	0.050
M	0°	8°	0°	8°
N	0.25	0.50	0.010	0.020
S	5.80	6.20	0.228	0.244

### SOLDERING FOOTPRINT\*

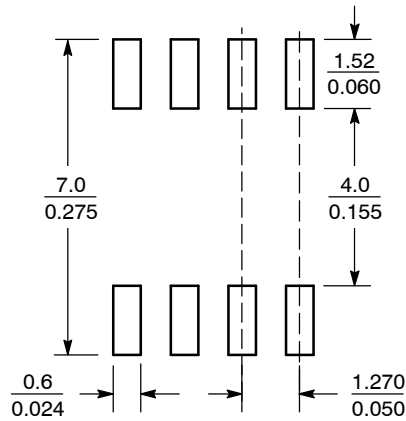

SCALE 6:1 (mm/inches)

\*For additional information on our Pb-Free strategy and soldering details, please download the ON Semiconductor Soldering and Mounting Techniques Reference Manual, SOLDERRM/D.

# NCP5104

## PACKAGE DIMENSIONS

8 LEAD PDIP  
CASE 626-05  
ISSUE L

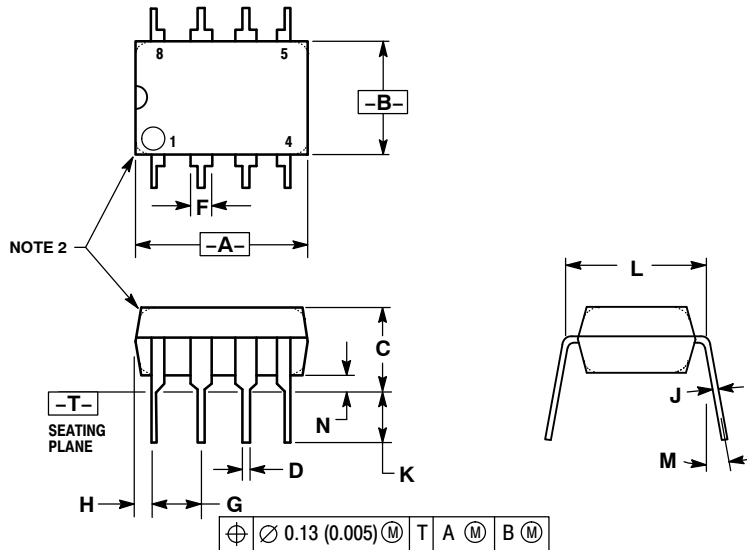

### NOTES:

1. DIMENSION L TO CENTER OF LEAD WHEN FORMED PARALLEL.
2. PACKAGE CONTOUR OPTIONAL (ROUND OR SQUARE CORNERS).
3. DIMENSIONING AND TOLERANCING PER ANSI Y14.5M, 1982.

DIM	MILLIMETERS		INCHES	
	MIN	MAX	MIN	MAX
A	9.40	10.16	0.370	0.400
B	6.10	6.60	0.240	0.260
C	3.94	4.45	0.155	0.175
D	0.38	0.51	0.015	0.020
F	1.02	1.78	0.040	0.070
G	2.54 BSC		0.100 BSC	
H	0.76	1.27	0.030	0.050
J	0.20	0.30	0.008	0.012
K	2.92	3.43	0.115	0.135
L	7.62 BSC		0.300 BSC	
M	---	10 <sup>°</sup>	---	10 <sup>°</sup>
N	0.76	1.01	0.030	0.040

ON Semiconductor and are registered trademarks of Semiconductor Components Industries, LLC (SCILLC). SCILLC reserves the right to make changes without further notice to any products herein. SCILLC makes no warranty, representation or guarantee regarding the suitability of its products for any particular purpose, nor does SCILLC assume any liability arising out of the application or use of any product or circuit, and specifically disclaims any and all liability, including without limitation special, consequential or incidental damages. "Typical" parameters which may be provided in SCILLC data sheets and/or specifications can and do vary in different applications and actual performance may vary over time. All operating parameters, including "Typicals" must be validated for each customer application by customer's technical experts. SCILLC does not convey any license under its patent rights nor the rights of others. SCILLC products are not designed, intended, or authorized for use as components in systems intended for surgical implant into the body, or other applications intended to support or sustain life, or for any other application in which the failure of the SCILLC product could create a situation where personal injury or death may occur. Should Buyer purchase or use SCILLC products for any such unintended or unauthorized application, Buyer shall indemnify and hold SCILLC and its officers, employees, subsidiaries, affiliates, and distributors harmless against all claims, costs, damages, and expenses, and reasonable attorney fees arising out of, directly or indirectly, any claim of personal injury or death associated with such unintended or unauthorized use, even if such claim alleges that SCILLC was negligent regarding the design or manufacture of the part. SCILLC is an Equal Opportunity/Affirmative Action Employer. This literature is subject to all applicable copyright laws and is not for resale in any manner.

### PUBLICATION ORDERING INFORMATION

**LITERATURE FULFILLMENT:**  
Literature Distribution Center for ON Semiconductor  
P.O. Box 5163, Denver, Colorado 80217 USA  
**Phone:** 303-675-2175 or 800-344-3860 Toll Free USA/Canada  
**Fax:** 303-675-2176 or 800-344-3867 Toll Free USA/Canada  
**Email:** orderlit@onsemi.com

**N. American Technical Support:** 800-282-9855 Toll Free  
USA/Canada  
**Europe, Middle East and Africa Technical Support:**  
Phone: 421 33 790 2910  
**Japan Customer Focus Center**  
Phone: 81-3-5773-3850

**ON Semiconductor Website:** [www.onsemi.com](http://www.onsemi.com)  
**Order Literature:** <http://www.onsemi.com/orderlit>

For additional information, please contact your local Sales Representative

Компания «Океан Электроники» предлагает заключение долгосрочных отношений при поставках импортных электронных компонентов на взаимовыгодных условиях!

Наши преимущества:

- Поставка оригинальных импортных электронных компонентов напрямую с производств Америки, Европы и Азии, а так же с крупнейших складов мира;
- Широкая линейка поставок активных и пассивных импортных электронных компонентов (более 30 млн. наименований);
- Поставка сложных, дефицитных, либо снятых с производства позиций;
- Оперативные сроки поставки под заказ (от 5 рабочих дней);
- Экспресс доставка в любую точку России;
- Помощь Конструкторского Отдела и консультации квалифицированных инженеров;
- Техническая поддержка проекта, помощь в подборе аналогов, поставка прототипов;
- Поставка электронных компонентов под контролем ВП;
- Система менеджмента качества сертифицирована по Международному стандарту ISO 9001;
- При необходимости вся продукция военного и аэрокосмического назначения проходит испытания и сертификацию в лаборатории (по согласованию с заказчиком);
- Поставка специализированных компонентов военного и аэрокосмического уровня качества (Xilinx, Altera, Analog Devices, Intersil, Interpoint, Microsemi, Actel, Aeroflex, Peregrine, VPT, Syfer, Eurofarad, Texas Instruments, MS Kennedy, Miteq, Cobham, E2V, MA-COM, Hittite, Mini-Circuits, General Dynamics и др.);

Компания «Океан Электроники» является официальным дистрибьютором и эксклюзивным представителем в России одного из крупнейших производителей разъемов военного и аэрокосмического назначения «JONHON», а так же официальным дистрибьютором и эксклюзивным представителем в России производителя высокотехнологичных и надежных решений для передачи СВЧ сигналов «FORSTAR».



## JONHON

«JONHON» (основан в 1970 г.)

Разъемы специального, военного и аэрокосмического назначения:

(Применяются в военной, авиационной, аэрокосмической, морской, железнодорожной, горно- и нефтедобывающей отраслях промышленности)

«FORSTAR» (основан в 1998 г.)

ВЧ соединители, коаксиальные кабели, кабельные сборки и микроволновые компоненты:

(Применяются в телекоммуникациях гражданского и специального назначения, в средствах связи, РЛС, а так же военной, авиационной и аэрокосмической отраслях промышленности).



Телефон: 8 (812) 309-75-97 (многоканальный)

Факс: 8 (812) 320-03-32

Электронная почта: [ocean@oceanchips.ru](mailto:ocean@oceanchips.ru)

Web: <http://oceanchips.ru/>

Адрес: 198099, г. Санкт-Петербург, ул. Калинина, д. 2, корп. 4, лит. А