



# MAGNET WIRE TERMINALS AND TERMINATION SYSTEMS

MAG-MATE terminals, SIAMEZE terminals, AMPLIVAR terminals and splices, and cluster blocks

**Table of Contents**

**Standard MAG-MATE Terminals**

|                                                      |    |
|------------------------------------------------------|----|
| Introduction.....                                    | 1  |
| Interconnection System.....                          | 2  |
| Termination Sequence.....                            | 2  |
| Test Results.....                                    | 3  |
| 300 Box Poke-In Terminals.....                       | 4  |
| 500 Box Poke-In Terminals.....                       | 6  |
| Poke-In Tab Terminals.....                           | 7  |
| MAG-MATE Terminals with extended leaf-spring.....    | 8  |
| 300 Box Poke-In Terminals.....                       | 9  |
| Tab Receptacle Terminals.....                        | 9  |
| 187 Box F-Crimp Terminals.....                       | 10 |
| 300 Box F-Crimp Terminals.....                       | 10 |
| Posted PCB Terminals.....                            | 11 |
| 300 Box Posted PCB Terminals.....                    | 11 |
| MAG-MATE Edge Leaf Terminals.....                    | 12 |
| 187 Box Posted PCB Terminals.....                    | 13 |
| 187 Box Tab Terminals.....                           | 13 |
| 300 Box Tab Terminals.....                           | 14 |
| Pin Receptacle Terminals.....                        | 15 |
| Pin I/O Terminals.....                               | 16 |
| 110 Series FASTON Tab Terminals.....                 | 17 |
| 187 Series FASTON Tab Terminals.....                 | 18 |
| 187 Series Combination Poke-In FASTON Terminals..... | 18 |
| 250 Series FASTON Tab Terminals.....                 | 21 |
| Typical Plastic Cavity.....                          | 23 |

**Slim Line MAG-MATE Terminals**

|                                      |    |
|--------------------------------------|----|
| Introduction.....                    | 25 |
| 187 Series FASTON Tab Terminals..... | 26 |
| 250 Series FASTON Tab Terminals..... | 26 |
| Posted PCB SOLDER Terminal.....      | 26 |
| Offset Tab Terminals.....            | 27 |

**Mini MAG-MATE Terminals**

|                                 |    |
|---------------------------------|----|
| Introduction.....               | 29 |
| Poke-In Terminal.....           | 30 |
| Posted Terminal.....            | 31 |
| FASTON Tab Terminals.....       | 31 |
| Crimp Wire Barrel Terminal..... | 31 |

**SIAMEZE Terminals**

|                                                     |    |
|-----------------------------------------------------|----|
| Introduction.....                                   | 32 |
| Lead Lok Terminals Introduction.....                | 33 |
| SIAMEZE Interconnection System.....                 | 34 |
| Lead Lok Interconnection System.....                | 35 |
| Wire-to-Wire Terminals.....                         | 36 |
| Receptacle Terminals (Wire to Blade).....           | 37 |
| Pin Terminals.....                                  | 37 |
| Post Terminals.....                                 | 38 |
| 110 Series (2.8 mm wide) FASTON Tab Terminals.....  | 39 |
| 187 Series (4.75 mm wide) FASTON Tab Terminals..... | 40 |
| 250 Series (6.3 mm wide) FASTON Tab Terminals.....  | 41 |
| Typical Plastic Cavity Pockets.....                 | 42 |

**Table of Contents**

**AMPLIVAR Splices**

Introduction ..... 44  
 General Application Guidelines ..... 46  
 Suggested Splice Selection Procedure ..... 46  
 Technical Documents ..... 46  
 9 Serrations —Pigtail Type ..... 47  
 7 Serrations —Pigtail Type ..... 47  
 5 Serrations —Thru Type ..... 48  
 5 Serrations —Pigtail Type ..... 49  
 Miniature Splice —Pigtail Type ..... 49

**AMPLIVAR Terminals**

Introduction ..... 50  
 Ring Tongue Terminals ..... 51  
 Stud Retaining Terminals ..... 52  
 Alternator Eyelet Terminal ..... 52  
 125 Series Blade ..... 53  
 187 Series FASTON Tabs ..... 53  
 250 Series FASTON Tabs ..... 53  
 250 Series FASTON Receptacles ..... 64  
 187 Series FASTON Flag Receptacles ..... 55  
 250 Series FASTON Flag Receptacles ..... 55  
 Pin Receptacles ..... 55  
 250 Series Stator Receptacles —7 Serrations ..... 56  
 Stator Terminal —Receptacle .250 x .032 [6.35 x 0.81] ..... 56

**Cluster Blocks**

Introduction ..... 57  
 Cluster Blocks 2.29 [.090] Pin Size (Lead Wire and Direct Connect) ..... 58  
 Cluster Blocks 3.18 [.125] Pin Size (Lead Wire and Direct Connect) ..... 60

**MTM Crimpband Splices - NOT RECOMMENDED FOR NEW DESIGNS**

Introduction ..... 62  
 MTM Crimpband Interconnection System ..... 63  
 11 Serrations ..... 64  
 9 Serrations ..... 64  
 7 Serrations ..... 65

**RTM Crimpband Splices - NOT RECOMMENDED FOR NEW DESIGNS**

Introduction ..... 66  
 RTM Crimpband Interconnection System ..... 67  
 20 Ridges ..... 68  
 14 Ridges ..... 68  
 10 Ridges ..... 68  
 9 Ridges ..... 69  
 8 Ridges ..... 69  
 7 Ridges ..... 69  
 6 Ridges ..... 72  
 3 Ridges ..... 73

**Power Splice**

Introduction ..... 74

**Table of Contents**

**Application Tooling**

Introduction..... 76

AMPLIVAR Product Terminator (APT) Machine..... 77

Power Splice Machine..... 77

AMPLIVAR Terminator for Parallel and End Connections..... 78

AMP-O-LECTRIC Model G Terminator with Thru-Splice Applicator..... 78

Crimband Application Tooling - **NO LONGER AVAILABLE**..... 79

MPT-5 MAG-MATE Product Terminator..... 80

MAG-MATE Terminal Cavity and Fixture Design..... 80

MPT-5 S/L Machine for SIAMEZE and Lead Lok Terminals..... 81

EMT -- Entry Level Magnet Wire Terminator..... 81

Manual Hand Tool..... 82

Manual Arbor Press..... 82

Hand Insertion Tools..... 82

Full Line of Crimp Tooling..... 82

MAG-MATE Inserter MK I with Pneumatic Control..... 83

MAG-MATE Inserter MK I with Electro Pneumatic Control..... 83

MAG-MATE and SIAMEZE Inserter MARK II with PLC..... 83

MAG-MATE and SIAMEZE Inserter MARK II with PLC and Insertion Force Control..... 84

Pneumatic Insertion Tool for MAG-MATE Terminals..... 84

Customer Specific Machines..... 85

Custom Built IDC Terminal Insertion Head..... 85

**Additional Data**

Technical Information..... 86

Terminal Stud Hole Size..... 90

Part Number Index..... 91

## Standard MAG-MATE Terminals

### Product Facts

- Terminates film-insulated copper and aluminum magnet wire
- Eliminates need for pre-stripping conductors
- Eliminates need to post insulate termination
- Excess magnet wire is automatically trimmed during the termination process
- Simultaneously terminates two magnet wires of the same size in one terminal (for splicing or bi-filing)
- Various lead wire attachment options available
- Available in strip form for semi-automatic or fully automatic insertions
- Available in loose piece form for hand tool insertions
- Varnish resist tab terminals are available for special applications
- High speed, fully automated integrated systems provide uniform terminations reliably at the lowest possible applied cost
- Clean metal-to-metal interface produces stable, gas-tight electrical terminations free of oxides and other contaminants
- Recognized under the Component Recognition Program of Underwriters Laboratories Inc., File No. E13288, Vol. 1, Sec 29



### Applications

- Motor windings and connections
- Coil connections
- Transformer windings and connections
- Bobbin connections
- Lighting ballasts
- Power supplies



TE offers a full selection of Standard MAG-MATE Insulation Displacement Crimp (IDC) terminals for magnet wire terminations.

MAG-MATE terminals are available in poke-in, poke-in tab, splice, crimp wire barrel, solder post, quick connect tab, pin and receptacle styles.

Standard MAG-MATE terminates magnet wire ranging from 34-12 AWG [0.16 -2.05 mm].

Each IDC slot size terminates a range of up to four consecutive magnet wire sizes.



Two magnet wires with the same diameter can be terminated in one terminal except as noted.

According to TE specifications MAG-MATE cavities are either integrated into coil bodies or specially designed cavity housings. The magnet wires are precisely positioned in the plastic cavity slots.

The MAG-MATE Inserter cuts the terminals from the strip and places the terminals over the magnet wire into the plastic cavities.

During this operation, small stripping shoulders in the IDC slot remove the film insulation from the magnet wire.

Wiping action between the wire and terminal removes oxides or other contaminants present on both the conductor and the terminal slot side walls, producing a clean, stable, gas-tight electrical termination.

Residual spring energy in the terminal causes the side walls of each IDC slot to function as opposing cantilever beams.

This constant pressure results in an intimate metal-to-metal interface, providing a reliable, long-term connection.

The MAG-MATE Inserter may be used as a semi-automatic bench machine or integrated into production lines for fully-automatic applications.

\*Contact TE Engineering for guidance regarding aluminum

**Standard MAG-MATE Terminals (Continued)**

**Standard MAG-MATE Interconnection System**

**How the System Operates**

**① Trim Blade**

This part cuts off the excess magnet wire and the wire support at the front of the cavity.

**② Insertion Finger**

The insertion finger is part of the MAG-MATE Inserter. It pushes the terminal that was sheared from the carrier strip through the inserter "tube" into the positioned cavity.

**③ Contact**

Various wire attachments in three different sizes, .187, .300, .500 cavity height (see tables).

**④ IDC Slot**

In different sizes for magnet wire diameters from 34-12 AWG [0.16-2.05 mm]. Strain relief slots available for high vibration applications.

**⑤ Stripping Shoulders**

During the insertion process, these shoulders strip the film insulation from the magnet wire in four areas.

**⑥ Locking Barbs**

Terminal retention is secured in the cavity by four locking barbs.

**⑦ Plastic Cavity**

Integration of plastic cavities into final unit must be in accordance with TE Application Specifications. **Consulting TE is required for design in.**

**⑧ Cavity Slot for Wire**

The width has to be in accordance with the wire size (see Application Specification).

**⑨ Magnet Wire**

The magnet wire is positioned down into the plastic cavity slots.

**⑩ Wire Support Block**

The block supports the magnet wire during the cutting process. The magnet wire is cut flush to the cavity front side.

**⑪ Support Anvil**

The anvil supports the wire during the insertion process.



**Termination Sequence**

- A = Prepare
- B = Insert
- C = Finish

- ① Trim Blade
- ② Insertion Finger
- ③ Poke-In Contact
- ④ Plastic Cavity
- ⑤ Magnet Wire
- ⑥ Support Anvil





**Standard MAG-MATE Terminals (Continued)**

**Test Results**

**Standard and Slim Line**

**MAG-MATE** products have been submitted to the following tests without significant millivolt increase:

**Current Cycling—**

480 cycles with each cycle consisting of 15 minutes "ON" followed by 15 minutes "OFF"

**Thermal Shock—**

25 cycles with each cycle consisting of 30 minutes at 125°C followed by 30 minutes at -65°C

**Humidity—**

**Temperature Cycling**

10 cycles between 25°C and 65°C at 95% RH

**Heat Age—**

33 days at 118°C

**Mini MAG-MATE**

products have been submitted to the following tests in addition to those listed without significant millivolt increase:

**Vibration—**

10-55-01- Hz traversed in 1 minute at .06 inches total excursion; 2 hours in each of 3 mutually perpendicular directions.

**Industrial Gas with Chlorine—**

1000 exposure to 200 ppb each of sulphur dioxide, nitrogen dioxide, hydrogen sulphide and 50 ppb chlorine.



**Test Current produces 100°C Magnet Wire Operating Temperature**



**Current Rating Curves**

The diagram shows the temperature rise of the contact, depending on the magnet wire size being applied.

**Product Specifications**

describe technical performance characteristics and verification tests. They are intended for the Design, Test and Quality Engineer.

- 108-2012 Standard .187 and .300 MAG-MATE Terminals
- 108-2053 Standard .500 Box MAG-MATE Terminals
- 108-1484 Slim Line MAG-MATE Terminals
- 108-2016 Mini MAG-MATE Terminals

**Note:** For all applications, TE recommends that samples of the magnet wire to be used be submitted for engineering evaluation.

Standard MAG-MATE Terminals

**Standard MAG-MATE Terminals (Continued)**

**300 Box Poke-In Terminals**

**Material**

Tin plated brass

**Typical Cavity Size 2**

(See page 23)

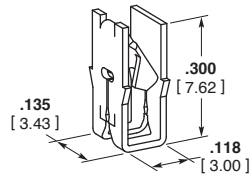

**A**

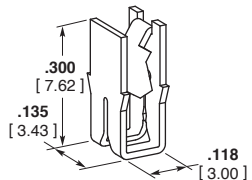

**B**

| Type                                               | Copper Magnet Wire Range <sup>1</sup>                                                    |           | Lead Wire Range <sup>3</sup> |                 | Mating <sup>5</sup> Tab    | Stock Thickness            | Strip Part Number* |
|----------------------------------------------------|------------------------------------------------------------------------------------------|-----------|------------------------------|-----------------|----------------------------|----------------------------|--------------------|
|                                                    | AWG                                                                                      | mm        | AWG                          | mm <sup>2</sup> |                            |                            |                    |
| A<br>300 Box<br>Standard IDC<br>Locking<br>Poke-in | 34-33                                                                                    | 0.16-0.18 | 20-18                        | 0.5-0.9         | .135 x .020<br>3.40 x 0.50 | .010<br>0.25               | 63662-1            |
|                                                    | 33-31                                                                                    | 0.18-0.23 | 20-18                        | 0.5-0.9         | .135 x .020<br>3.40 x 0.50 | .010<br>0.25               | 62431-1            |
|                                                    | 31-28                                                                                    | 0.23-0.32 | 20-18                        | 0.5-0.9         | .135 x .020<br>3.40 x 0.50 | .012<br>0.30               | 1217234-1          |
|                                                    | 30-27                                                                                    | 0.25-0.36 | 20-18                        | 0.5-0.9         | .135 x .020<br>3.40 x 0.50 | .012<br>0.30               | 62429-1            |
|                                                    | 27-23                                                                                    | 0.36-0.57 | 20-18                        | 0.5-0.9         | .135 x .020<br>3.40 x 0.50 | .016<br>0.41               | 62935-1            |
|                                                    | 25-22 <sup>2</sup>                                                                       | 0.45-0.64 | 20-18                        | 0.5-0.9         | .135 x .020<br>3.40 x 0.50 | .016<br>0.41               | 63658-1            |
|                                                    | 22-20 <sup>2</sup>                                                                       | 0.64-0.81 | 20-18                        | 0.5-0.9         | .135 x .020<br>3.40 x 0.50 | .016<br>0.41               | 62420-1            |
|                                                    | 20 <sup>2</sup>                                                                          | 0.81      | 20-18                        | 0.5-0.9         | .135 x .020<br>3.40 x 0.50 | .016<br>0.41               | 63591-1            |
|                                                    | 19-17 <sup>2</sup>                                                                       | 0.91-1.15 | 20-18                        | 0.5-0.9         | .135 x .020<br>3.40 x 0.50 | .016<br>0.41               | 62833-1            |
|                                                    | B <sup>4</sup><br>300 Box<br>Standard IDC w/<br>Strain Relief Slot<br>Locking<br>Poke-in | 30        | 0.25                         | 20-18           | 0.5-0.9                    | .135 x .020<br>3.40 x 0.50 | .012<br>0.30       |
| 29-28                                              |                                                                                          | 0.29-0.32 | 20-18                        | 0.5-0.9         | .135 x .020<br>3.40 x 0.50 | .012<br>0.30               | 1217011-1          |
| 28-26                                              |                                                                                          | 0.32-0.40 | 20-18                        | 0.5-0.9         | .135 x .020<br>3.40 x 0.50 | .012<br>0.30               | 1217368-1          |
| 27-23                                              |                                                                                          | 0.36-0.57 | 20-18                        | 0.5-0.9         | .135 x .020<br>3.40 x 0.50 | .016<br>0.41               | 63789-1            |

- 1 Two magnet wires may be terminated in the same terminal slot if diameters are equal.
- 2 Single magnet wire only; 22 AWG [0.64 mm] or larger unless otherwise noted.
- 3 Solid or overcoated stranded lead wire only. Product will also accept Poke-In Tab Terminal shown on page 7.
- 4 Strain relief slot for high vibration applications.
- 5 See page 7 for mating tab options.
- \* Recognized under the Component Program of Underwriters Laboratories, Inc.

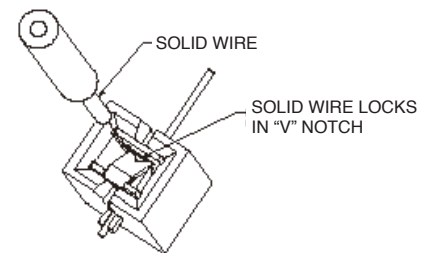
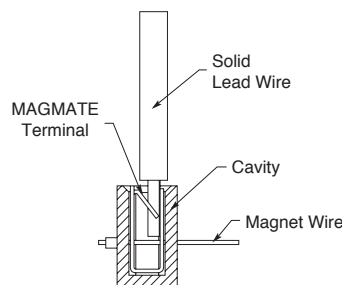
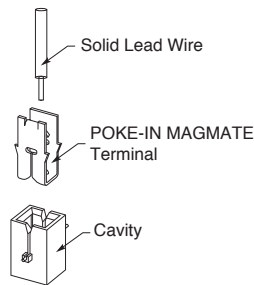

**POKE-IN SYSTEM: SOLID WIRE CONNECTION**

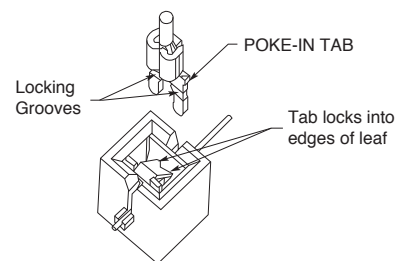
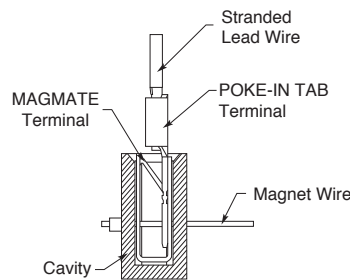
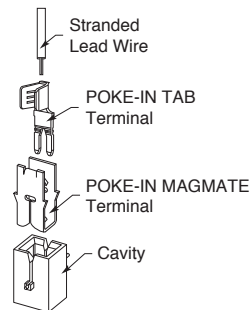

**POKE-IN SYSTEM: STRANDED LEAD WIRE AND POKE-IN TAB CONNECTION**



Standard MAG-MATE Terminals (Continued)



A



B



C



D

| Type                                                        | Copper Magnet Wire Range <sup>1</sup> |            | Mating Tab <sup>3</sup>    | Stock Thickness | Strip Part Number*     |
|-------------------------------------------------------------|---------------------------------------|------------|----------------------------|-----------------|------------------------|
|                                                             | AWG                                   | mm         |                            |                 |                        |
| A<br>300 Box<br>Standard IDC<br>Non-Locking<br>Poke-In MKI  | 35-32                                 | 0.14-0.20  | .135 x .020<br>3.40 x 0.50 | .010<br>0.25    | 969082-1               |
|                                                             | 33-30                                 | 0.18-0.265 | .135 x .020<br>3.40 x 0.50 | .010<br>0.25    | 926850-2               |
|                                                             | 30-26                                 | 0.265-0.40 | .135 x .020<br>3.40 x 0.50 | .013<br>0.32    | 926851-2               |
|                                                             | 26-21.5 <sup>2</sup>                  | 0.40-0.67  | .135 x .020<br>3.40 x 0.50 | .016<br>0.41    | 926852-2               |
|                                                             | 21.5-18.5 <sup>2</sup>                | 0.67-0.95  | .135 x .020<br>3.40 x 0.50 | .016<br>0.41    | 928770-2               |
| B<br>300 Box<br>Standard IDC<br>Non-Locking<br>Poke-In MKII | 19.5-17 <sup>2</sup>                  | 0.91-1.13  | .135 x .020<br>3.40 x 0.50 | .016<br>0.41    | 1-928771-4             |
|                                                             | 33-30                                 | 0.18-0.265 | .135 x .020<br>3.40 x 0.50 | .013<br>0.32    | 964337-2               |
|                                                             | 30-26                                 | 0.265-0.40 | .135 x .020<br>3.40 x 0.50 | .013<br>0.32    | 964338-2               |
|                                                             | 26-22 <sup>2</sup>                    | 0.40-0.63  | .135 x .020<br>3.40 x 0.50 | .013<br>0.32    | 964339-2               |
|                                                             | 22-19.5 <sup>2</sup>                  | 0.63-0.85  | .135 x .020<br>3.40 x 0.50 | .013<br>0.32    | 964340-2               |
| C<br>433 Box<br>Standard IDC<br>with Receptacle<br>for Tabs | 19.5-17 <sup>2</sup>                  | 0.85-1.12  | .135 x .020<br>3.40 x 0.50 | .013<br>0.32    | 964341-2               |
|                                                             | 33-30                                 | 0.18-0.265 | w/o Dimple<br>Dimple       | .013<br>0.32    | 1-964114-1<br>964114-1 |
|                                                             | 30-26                                 | 0.265-0.40 | w/o Dimple<br>Dimple       | .013<br>0.32    | 1-964108-1<br>964108-1 |
|                                                             | 26-22                                 | 0.40-0.63  | w/o Dimple<br>Dimple       | .013<br>0.32    | 1-928854-1<br>928854-1 |
|                                                             | 22-19.5 <sup>2</sup>                  | 0.63-0.85  | w/o Dimple<br>Dimple       | .013<br>0.32    | 1-964106-1<br>964106-1 |
| D<br>433 Box<br>Standard IDC<br>with Receptacle<br>for Tabs | 33-31                                 | 0.18-0.265 | Dimple                     | .013<br>0.32    | 1740574-1              |
|                                                             | 26-23                                 | 0.40-0.57  | w/o Dimple                 | .013<br>0.32    | 964252-1               |
|                                                             | 22.5 - 20 <sup>2</sup>                | 0.60-0.80  | w/o Dimple                 | .013<br>0.32    | 964110-1               |
|                                                             | 19-17 <sup>2</sup>                    | 0.90-1.13  | w/o Dimple                 | .013<br>0.32    | 964111-1               |
|                                                             | 19-17 <sup>1</sup>                    | 0.90-1.12  | w/o Dimple                 | .013<br>0.32    | 1534234-1              |

<sup>1</sup> Two magnet wires may be terminated in the same terminal slot if diameters are equal.

<sup>2</sup> Single magnet wire only; 22 AWG [0.64 mm] or larger unless otherwise noted.

<sup>3</sup> See page 7 for mating tab options.

\* Recognized under the Component Program of Underwriters Laboratories, Inc.

Standard MAG-MATE Terminals (Continued)

300 Box Poke-In Terminals

(Continued)

Material

Tin plated brass

Typical Cavity Size 2

(See page 23)

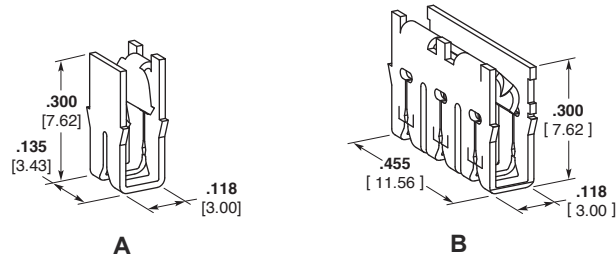

**Note:** Special cavity required for Tri-slot splice terminal. See Application Spec. 114-2046.

| Type                                                                                        | Copper Magnet Wire Range <sup>1</sup>                       |                                   | Mating Tab <sup>4</sup>    | Stock Thickness | Strip Part Number |
|---------------------------------------------------------------------------------------------|-------------------------------------------------------------|-----------------------------------|----------------------------|-----------------|-------------------|
|                                                                                             | AWG                                                         | mm                                |                            |                 |                   |
| A <sup>3</sup><br>300 Box<br>Standard IDC<br>w/Strain Relief Slot<br>Non-Locking<br>Poke-In | 27-26                                                       | 0.36-0.40                         | .135 x .020<br>3.40 x 0.50 | .016<br>0.41    | 1217691-1         |
|                                                                                             | 25.5-24                                                     | 0.43-0.51                         | .135 x .020<br>3.40 x 0.50 | .016<br>0.41    | 1217690-1         |
|                                                                                             | 23.5-22 <sup>2</sup>                                        | 0.54-0.64                         | .135 x .020<br>3.40 x 0.50 | .016<br>0.41    | 1217689-1         |
|                                                                                             | 21.5-20 <sup>2</sup>                                        | 0.68-0.81                         | .135 x .020<br>3.40 x 0.50 | .016<br>0.41    | 1217688-1         |
| B<br>300 Box<br>Standard IDC<br>Non-Locking<br>Poke-In                                      | 30-27                                                       | 0.25-0.36                         | .135 x .020<br>3.40 x 0.50 | .016<br>0.41    | 1217221-1         |
|                                                                                             | 27-23                                                       | 0.36-0.57                         | .135 x .020<br>3.40 x 0.50 | .016<br>0.41    | 63632-1           |
|                                                                                             | 23-20 <sup>2</sup>                                          | 0.57-0.81                         | .135 x .020<br>3.40 x 0.50 | .016<br>0.41    | 1217533-1         |
|                                                                                             | 19-17                                                       | 0.91-1.15                         | .135 x .020<br>3.40 x 0.50 | .016<br>0.41    | 1742347-1         |
|                                                                                             | 27-23 <sup>2</sup><br>19-17 <sup>2</sup><br>18 <sup>2</sup> | 0.36-0.57<br>0.91-1.15<br>0.8-0.9 | .135 x .020<br>3.40 x 0.50 | .016<br>0.41    | 63975-1           |

- 1 Two magnet wires may be terminated in the same terminal slot if diameters are equal.
- 2 Single magnet wire only; 22 AWG [0.64 mm] or larger.
- 3 Strain relief slot for high vibration applications.
- 4 See page 7 for mating small tab options.

\* Recognized under the Component Program of Underwriters Laboratories, Inc.

500 Box Poke-In Terminals

Material

Tin plated brass

Typical Cavity Size 4

(See page 23)

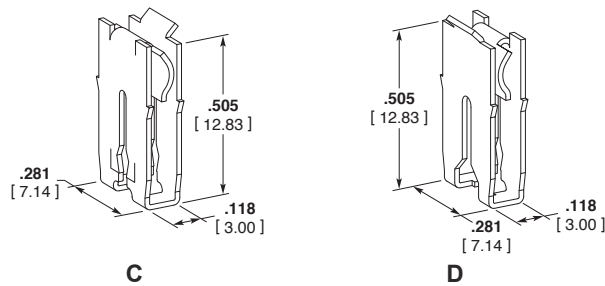

**Note:** Mating poke-in tab

1217324-1

(See Type H, Page 7)

| Type                                                                                         | Copper Magnet Wire Range <sup>1</sup> |           | Stock Thickness | Strip Part Number |
|----------------------------------------------------------------------------------------------|---------------------------------------|-----------|-----------------|-------------------|
|                                                                                              | AWG                                   | mm        |                 |                   |
| C<br>500 Box<br>Standard IDC<br>Non-Locking<br>Poke-In                                       | 23-19.5                               | 0.57-0.86 | .016<br>0.41    | 1217069-1         |
|                                                                                              | 19-17                                 | 0.91-1.15 | .016<br>0.41    | 1217068-1         |
|                                                                                              | 16-15                                 | 1.29-1.45 | .016<br>0.41    | 1217067-1         |
| D <sup>3</sup><br>500 Box<br>Standard IDC w/<br>Strain Relief Slot<br>Non-Locking<br>Poke-In | 23-21.5                               | 0.57-0.68 | .016<br>0.41    | 1217358-1         |
|                                                                                              | 21-19.5                               | 0.72-0.86 | .016<br>0.41    | 1217357-1         |
|                                                                                              | 19-17                                 | 0.91-1.15 | .016<br>0.41    | 1217356-1         |
|                                                                                              | 17-16                                 | 1.15-1.29 | .016<br>0.41    | 1742203-1         |
|                                                                                              | 16-15                                 | 1.29-1.45 | .016<br>0.41    | 1217355-1         |
|                                                                                              | 14-13 <sup>2</sup>                    | 1.61-1.83 | .016<br>0.41    | 1217579-1         |

- 1 Two magnet wires may be terminated in the same terminal slot if diameters are equal.
- 2 Single magnet wire only.
- 3 Strain relief slot for high vibration applications.

Standard MAG-MATE Terminals (Continued)

Poke-In Tab Terminals

Material

Tin plated brass

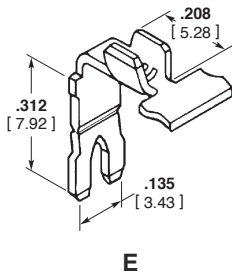

| Type                         | Lead Wire Size <sup>1</sup> |                 | Ins. O.D. | Stock Thickness | Strip Part Number     |
|------------------------------|-----------------------------|-----------------|-----------|-----------------|-----------------------|
|                              | AWG                         | mm <sup>2</sup> |           |                 |                       |
| A<br>90° Up                  | 22-18                       | 0.3-0.9         | —         | .018            | 62895-1*              |
|                              |                             |                 |           | 0.46            | 63410-1               |
| B<br>90° Up<br>w/Ins. Sup.   | 24                          | 0.2             | .040-.060 | .018            | 1742828-1             |
|                              |                             |                 | 1.02-1.52 | 0.46            |                       |
|                              |                             |                 | .060-.100 | .018            | 62896-1*              |
| C<br>Straight                | 18-14                       | 0.8-2.0         | 1.52-2.54 | 0.46            | 63218-1               |
|                              |                             |                 | .090-.140 | .018            | 62897-1*              |
|                              |                             |                 | 2.29-3.56 | 0.46            |                       |
| D<br>Straight<br>w/Ins. Sup. | 22-18                       | 0.3-0.9         | —         | .020            | 62897-1*              |
|                              |                             |                 | .020      | 0.51            | 63775-1               |
|                              |                             |                 | .060-.100 | .020            | 62898-1*              |
|                              |                             |                 | 1.52-2.54 | 0.51            |                       |
| E<br>90° Down                | 18-14                       | 0.8-2.0         | .090-.140 | .020            | 63397-1               |
|                              |                             |                 | 2.29-3.56 | 0.51            |                       |
|                              |                             |                 | .118 MAX. | .018            | 281622-2 <sup>2</sup> |
|                              |                             |                 | 3.00 MAX. | 0.45            | 281623-2 <sup>2</sup> |
| E<br>90° Down                | 20-17                       | 0.5-1.0         | .118 MAX. | .018            | 964101-2 <sup>3</sup> |
|                              |                             |                 | 3.00 MAX. | 0.45            | 964290-1 <sup>4</sup> |
| E<br>90° Down                | 20-17                       | 0.5-1.0         | .063-.090 | .018            | 63364-1               |
|                              |                             |                 | 1.60-2.30 | 0.45            | 1742125-1             |

1 Stranded, fused stranded or solid lead wire.

2 Can be selectively bent inside applicator. With support flanges, can only be used in combination with modified cavity IA-84-5157

3 Can be selectively bent inside applicator, Non-locking

4 Can be selectively bent inside applicator. Non-locking; use with housing

\* Recognized under the Component Program of Underwriters Laboratories, Inc.

Note: All tab terminals accept stranded, fused stranded or solid lead wire.

Standard MAG-MATE Terminals (Continued)

Poke-In Tab Terminals

Material

Tin plated brass  
Pre-Tin plated brass



K



L



F



I



J

| Type                         | Lead Wire Size <sup>1</sup> |                 | Ins. O.D.              | Stock Thickness | Strip Part Number |
|------------------------------|-----------------------------|-----------------|------------------------|-----------------|-------------------|
|                              | AWG                         | mm <sup>2</sup> |                        |                 |                   |
| F<br>90° Down<br>w/Ins. Sup. | 24-20                       | 0.2-0.5         | .048-.078<br>1.22-1.98 | .020<br>0.51    | 1742410-1         |
|                              | 22-18                       | 0.3-0.9         | .060-.100<br>1.52-2.54 | .020<br>0.51    | 1742211-1         |
|                              | 18-14                       | 0.8-2.0         | .090-.140<br>2.29-3.56 | .020<br>0.51    | 63458-1           |
| Flag - 300 Box only          | 20-16                       | 0.5-1.4         | —                      | .020<br>0.51    | 1217406-1         |
| Flag - 500 Box only          | 18-14                       | 0.8-2.0         | .080-.120<br>2.03-3.05 | .020<br>0.51    | 1217324-1         |
| K<br>Bridge Contact          | —                           | —               | —                      | .020<br>0.51    | 1987199-1         |
| L<br>PCB Contact             | —                           | —               | —                      | .020<br>0.51    | 1217041-1         |

Note: All tab terminals accept stranded, fused stranded or solid lead wire.

MAG-MATE Terminals with extended leaf-spring

Material

Pre-tinned copper alloy



M

| Type                                                | Copper Magnet Wire Range |            | Stock Thickness | Strip Part Number |
|-----------------------------------------------------|--------------------------|------------|-----------------|-------------------|
|                                                     | AWG                      | mm         |                 |                   |
| M<br>Mag-Mate Terminal with<br>extended Leaf-Spring | 33-30                    | 0.18-0.265 | .013<br>0.32    | 1740603-1         |
|                                                     | 30-26                    | 0.265-0.40 | .013<br>0.32    | 1740698-2         |
|                                                     | 26.5-22.5                | 0.375-0.60 | .013<br>0.32    | 1534110-1         |
|                                                     | 22.5-20                  | 0.60-0.80  | .013<br>0.32    | 969125-1*         |
|                                                     | 19.5-17                  | 0.85-1.12  | .013<br>0.32    | 1418686-1         |

\*Single magnet wire

Note: Special cavity is required, contact TE connectivity for information.

Standard MAG-MATE Terminals (Continued)

300 Box Poke-In Terminals

**Material**

Tin plated brass

**.300 [7.62] Series Box**

Typical Cavity Size 2

(See page 23)

**Note:** Special cavity required for Tri-slot splice terminal. See application SPEC 114-2046



| Type                                               | Copper Magnet Wire Range <sup>1</sup> |           | Stock Thickness | Strip Part Number      |
|----------------------------------------------------|---------------------------------------|-----------|-----------------|------------------------|
|                                                    | AWG                                   | mm        |                 |                        |
| A<br>300 Box<br>Standard IDC<br>Splice             | 22-20                                 | 0.64-0.81 | .016<br>0.41    | 1217973-1              |
|                                                    | 19-17                                 | 0.91-1.15 | .020<br>0.51    | 1742159-1 <sup>4</sup> |
|                                                    | 28-24                                 | 0.32-0.51 | .016<br>0.41    | 1217858-1              |
| B<br>300 Box<br>Standard IDC<br>Tri-Slot<br>Splice | 23-20 <sup>2</sup>                    | 0.57-0.81 | .016<br>0.41    | 1217853-1              |
|                                                    | 27-23                                 | 0.36-0.57 |                 |                        |
|                                                    | 18 <sup>4</sup>                       | 0.8-0.9   | .016<br>0.41    | 1217613-1              |
|                                                    | 19-17 <sup>2</sup>                    | 0.91-1.15 |                 |                        |
|                                                    | 25-22 <sup>3</sup>                    | 0.45-0.64 |                 |                        |
|                                                    | 18 <sup>4</sup>                       | 0.8-0.9   | .016<br>0.41    | 1217209-1              |
|                                                    | 23.5-20 <sup>2</sup>                  | 0.54-0.81 |                 |                        |

1 Two magnet wires may be terminated in the same terminal slot if diameters are equal.  
 2 Single magnet wire only; 22 AWG [0.64 mm] or larger.  
 3 Single solid or fused stranded lead wire only.  
 4 Special cavity required for 1742159-1.

Tab Receptacle Terminals

**Material**

Tin plated phos. bronze

**Note:** Special cavity required. Contact TE Engineering for details.



| Type                                           | Copper Magnet Wire Range <sup>1</sup> |           | Mating Tab                 | Stock Thickness | Strip Part Number |
|------------------------------------------------|---------------------------------------|-----------|----------------------------|-----------------|-------------------|
|                                                | AWG                                   | mm        |                            |                 |                   |
| C<br>185 Box<br>Standard IDC<br>Tab Receptacle | 32-31                                 | 0.20-0.23 | .070 x .020<br>1.78 x 0.51 | .010<br>0.25    | 1217538-1         |
|                                                | 30-28                                 | 0.25-0.32 | .070 x .020<br>1.78 x 0.51 | .010<br>0.25    | 1217457-1         |
|                                                | 29-28                                 | 0.29-0.32 | .070 x .020<br>1.78 x 0.51 | .010<br>0.25    | 1217458-1         |
|                                                | 28-27                                 | 0.32-0.36 | .070 x .020<br>1.78 x 0.51 | .010<br>0.25    | 1742781-1         |

1 Two magnet wires may be terminated in the same slot if diameters are equal.

Standard MAG-MATE Terminals (Continued)

187 Box F-Crimp Terminals

Material

Tin plated brass

.187 [4.75] Series Box

Typical Cavity Size 1

(See page 23)



| Type                                    | Copper Magnet Wire Range <sup>1</sup> |           | Lead Wire Range <sup>3</sup> |                 | Ins. O.D.              | Stock Thickness | Strip Part Number    |
|-----------------------------------------|---------------------------------------|-----------|------------------------------|-----------------|------------------------|-----------------|----------------------|
|                                         | AWG                                   | mm        | AWG                          | mm <sup>2</sup> |                        |                 |                      |
| A<br>187 Box<br>Standard IDC<br>F-Crimp | 33-31                                 | 0.18-0.23 | 26-22                        | 0.12-0.3        | —                      | .010<br>0.25    | 63039-1              |
|                                         | 30-28                                 | 0.25-0.32 | 26-22                        | 0.12-0.3        | —                      | .012<br>0.30    | 63036-1              |
|                                         | 27-25                                 | 0.36-0.46 | 26-22                        | 0.12-0.3        | —                      | .012<br>0.30    | 62609-1 <sup>4</sup> |
|                                         | 26-24                                 | 0.40-0.51 | 22-18                        | 0.3-1.0         | —                      | .012<br>0.30    | 1217146-1            |
|                                         | 24-22 <sup>2</sup>                    | 0.51-0.64 | 26-22                        | 0.12-0.3        | —                      | .012<br>0.30    | 62610-1 <sup>4</sup> |
| B<br>187 Box F-Crimp<br>w/Ins Sup.      | 27-25                                 | 0.36-0.46 | 22-18                        | 0.3-1.0         | .071-.088<br>1.80-2.23 | .012<br>0.30    | 63856-1              |

- 1 Two magnet wires may be terminated in the same terminal slot if diameters are equal.
- 2 Single magnet wire only.
- 3 Stranded, fused stranded or solid lead wire.
- 4 Strip rereeled to feed through mini-applicator to crimp lead wire first, magnet wire termination is secondary operation.

300 Box F-Crimp Terminals

Material

Tin plated brass

.300 [7.62] Series Box

Typical Cavity Size 2, when "C" dimension is .120 [3.05]

(See page 23)

Typical Cavity Size 6, when "C" dimension is .070 [1.78]

(See page 23)

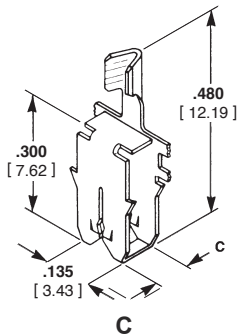

| Type                                    | Copper Magnet Wire Range <sup>1</sup> |           | Dim. C       | Lead Wire Range <sup>3</sup> |                 | Stock Thickness | Strip Part Number |
|-----------------------------------------|---------------------------------------|-----------|--------------|------------------------------|-----------------|-----------------|-------------------|
|                                         | AWG                                   | mm        |              | AWG                          | mm <sup>2</sup> |                 |                   |
| C<br>300 Box<br>Standard IDC<br>F-Crimp | 33-31                                 | 0.18-0.23 | .070<br>1.78 | 22-18                        | 0.3-1.0         | .012<br>0.30    | 63235-1           |
|                                         |                                       |           | .120<br>3.05 | 24-20                        | 0.2-0.6         | .012<br>0.30    | 63420-1           |
|                                         | 31-28                                 | 0.23-0.32 | .070<br>1.78 | 22-18                        | 0.3-1.0         | .012<br>0.30    | 63236-1           |
|                                         |                                       |           | .070<br>1.78 | 24-20                        | 0.2-0.6         | .012<br>0.30    | 1742614-1         |
|                                         | 30-27                                 | 0.25-0.36 | .120<br>3.05 | 24-20                        | 0.2-0.6         | .012<br>0.30    | 62992-1           |
|                                         | 28-24                                 | 0.32-0.51 | .120<br>3.05 | 24-20                        | 0.2-0.6         | .012<br>0.30    | 63641-1           |
|                                         | 27-24                                 | 0.36-0.51 | .070<br>1.78 | 22-18                        | 0.3-1.0         | .012<br>0.30    | 63237-1           |
|                                         | 27-23                                 | 0.36-0.57 | .120<br>3.05 | 24-20                        | 0.2-0.6         | .016<br>0.41    | 62459-1           |
|                                         | 25-22                                 | 0.45-0.64 | .070<br>1.78 | 22-18                        | 0.3-1.0         | .012<br>0.30    | 63690-1           |
|                                         | 22-20 <sup>2</sup>                    | 0.64-0.81 | .120<br>3.05 | 24-20                        | 0.2-0.6         | .016<br>0.41    | 62458-1           |
|                                         | 19-17 <sup>2</sup>                    | 0.91-1.15 | .120<br>3.05 | 22-18                        | 0.3-1.0         | .016<br>0.41    | 63504-1           |

- 1 Two magnet wires may be terminated in the same terminal slot if diameters are equal.
- 2 Single magnet wire only; 22 AWG [0.64 mm] or larger.
- 3 Stranded, fused stranded or solid lead wire.



**Standard MAG-MATE Terminals (Continued)**

**300 Box Posted PCB Terminals**

**Multi-Spring Solderless Terminal**

**Material**

Tin over Copper Alloy

**Cavity Size**

Application Spec.  
114-74109 with 114-74109-5

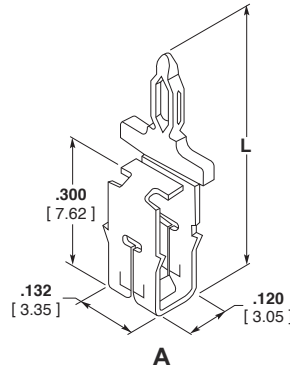

| Type                                          | Copper Magnet Wire Range <sup>1</sup> |            | Dim L | Stock Thickness |                  | Strip Part Number |
|-----------------------------------------------|---------------------------------------|------------|-------|-----------------|------------------|-------------------|
|                                               | AWG                                   | mm         |       | Tab Section     | Mag Wire Section |                   |
| A<br>Multi-Spring Solderless PCB Tab Terminal | 33-29.5                               | 0.18-0.265 | .583  | .031            | .013             | 1247000-2         |
|                                               |                                       |            | 14.80 | 0.80            | 0.32             |                   |
|                                               | 29.5-26                               | 0.265-0.40 | .583  | .031            | .013             | 1247001-2         |
|                                               |                                       |            | 14.80 | 0.80            | 0.32             |                   |
|                                               | 26-22.5                               | 0.40-0.63  | .583  | .031            | .013             | 1247002-2         |
| 14.80                                         |                                       |            | 0.80  | 0.32            |                  |                   |
| 22.5-19.5 <sup>2</sup>                        | 0.63-0.85                             | .583       | .031  | .013            | 1247003-2        |                   |
|                                               |                                       | 14.80      | 0.80  | 0.32            |                  |                   |
| 19.5-17 <sup>2</sup>                          | 0.85-1.12                             | .583       | .031  | .013            | 1247004-2        |                   |
|                                               |                                       | 14.80      | 0.80  | 0.32            |                  |                   |

1 Two magnet wires may be terminated in the same terminal slot if diameters are equal.  
2 Single magnet wire only. 22 awg [0.63 mm] and larger.

**Note:** PC Board hole size .057 [1.45].

**300 Box Posted PCB Terminals Solder Terminal**

**Material**

Tin over copper plated brass

**Typical Cavity Size**

(See page 23)  
Type C—Cavity Size 2  
Type D—Cavity Size 6

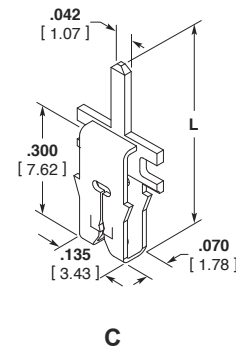

| Type                               | Copper Magnet Wire Range <sup>1</sup> |           | Dim. L | Stock Thickness |           | Strip Part Number |
|------------------------------------|---------------------------------------|-----------|--------|-----------------|-----------|-------------------|
|                                    | AWG                                   | mm        |        | Tab Section     | Mag Wire  |                   |
| B<br>300 Box Standard IDC PCB Post | 33-31                                 | 0.18-0.23 | .540   | .010            | .010      | 63253-1           |
|                                    |                                       |           | 13.72  | 0.25            | 0.25      |                   |
|                                    | 31-28                                 | 0.23-0.32 | .540   | .010            | .010      | 62928-1*          |
|                                    |                                       |           | 13.72  | 0.25            | 0.25      |                   |
|                                    | 29-26                                 | 0.29-0.40 | .540   | .012            | .012      | 62958-1*          |
|                                    |                                       |           | 13.72  | 0.30            | 0.30      |                   |
|                                    | 27-23                                 | 0.36-0.57 | .460   | .016            | .016      | 63659-1           |
| 11.68                              |                                       |           | 0.41   | 0.41            |           |                   |
| 22-20 <sup>2</sup>                 | 0.64-0.81                             | .460      | .016   | .016            | 63660-1   |                   |
|                                    |                                       | 11.68     | 0.41   | 0.41            |           |                   |
| 19-17 <sup>2</sup>                 | 0.91-1.15                             | .460      | .016   | .016            | 63661-1   |                   |
|                                    |                                       | 11.68     | 0.41   | 0.41            |           |                   |
| 19-17 <sup>2</sup>                 | 0.91-1.15                             | .570      | .016   | .016            | 1742708-1 |                   |
|                                    |                                       | 14.48     | 0.41   | 0.41            |           |                   |
| C<br>PCB Post Shallow Box          | 33-31                                 | 0.18-0.23 | .475   | .020            | .012      | 1217302-1         |
|                                    |                                       |           | 12.07  | 0.51            | 0.30      |                   |

1 Two magnet wires may be terminated in the same terminal slot if diameters are equal.

2 Single magnet wire only.

\* Recognized under the Component Program of Underwriters Laboratories, Inc.

**Note:** PC Board hole size .050 [1.27].

**Standard MAG-MATE Terminals (Continued)**

**MAG-MATE  
Edge Leaf Terminal**

**Material**

Pre-tinned brass  
Brass

**Cavity**

411-18517

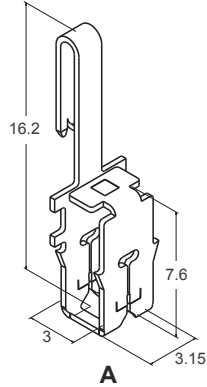

|                                  | Copper Magnet Wire Range |            | Cavity Size | Stock Thickness | Strip Part Number |
|----------------------------------|--------------------------|------------|-------------|-----------------|-------------------|
|                                  | AWG                      | mm         |             |                 |                   |
| A<br>MAG-MATE<br>Contact RAST 5D | 33-30                    | 0.18-0.265 | 2           | .013<br>0.32    | 1394429-2         |
|                                  | 30-26                    | 0.265-0.40 | 2           | .013<br>0.32    | 1394430-2         |
|                                  | 26-22                    | 0.40-0.63  | 2           | .013<br>0.32    | 1394431-2         |
|                                  | 22-20                    | 0.63-0.80  | 2           | .013<br>0.32    | 1394432-2         |
|                                  | 20-17                    | 0.85-1.12  | 2           | .013<br>0.32    | 1394433-2         |

**Note:** Special cavity required. Contact TE Connectivity for information

**Material**

Unplated brass

**Cavity**

411-18517



| Type                               | Copper Magnet Wire Range |            | Cavity Size | Stock Thickness | Strip Part Number |
|------------------------------------|--------------------------|------------|-------------|-----------------|-------------------|
|                                    | AWG                      | mm         |             |                 |                   |
| B<br>MAG-MATE<br>Edge Leaf Contact | 33-30                    | 0.18-0.265 | 2           | .013<br>0.32    | 1-1987143-1       |

**Note:** Special cavity required. Contact TE Connectivity for information

Standard MAG-MATE Terminals (Continued)

187 Box Posted PCB Terminals

Material

Tin plated brass

Typical Cavity Size 1

(See page 23)

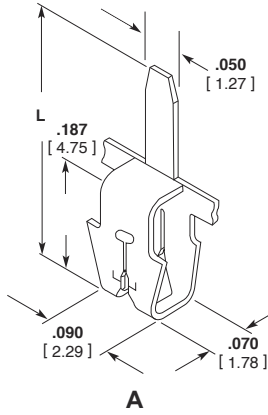

| Type                                     | Copper Magnet Wire Range <sup>1</sup> |           | Dim. L | Stock Thickness |         | Strip Part Number |
|------------------------------------------|---------------------------------------|-----------|--------|-----------------|---------|-------------------|
|                                          | AWG                                   | mm        |        |                 |         |                   |
| A<br>185 Box<br>Standard IDC<br>PCB Post | 33-31                                 | 0.18-0.23 | .267   | .010            | 63565-1 |                   |
|                                          |                                       |           | 6.78   | 0.25            |         |                   |
|                                          | 30-28                                 | 0.25-0.32 | .330   | .010            | 62938-1 |                   |
|                                          |                                       |           | 8.38   | 0.25            |         |                   |
|                                          |                                       |           | .267   | .012            | 63160-1 |                   |
|                                          |                                       |           | 6.78   | 0.30            |         |                   |
| 27-25                                    | 0.36-0.46                             | .287      | .012   | 63818-1         |         |                   |
|                                          |                                       | 7.29      | 0.30   |                 |         |                   |
| 24-22 <sup>2</sup>                       | 0.51-0.64                             | .330      | .012   | 62430-1         |         |                   |
|                                          |                                       | 8.38      | 0.30   |                 |         |                   |
|                                          |                                       | .287      | .012   | 63819-1         |         |                   |
|                                          |                                       | 7.29      | 0.30   |                 |         |                   |
|                                          |                                       | .330      | .012   | 62439-1         |         |                   |
|                                          |                                       | 8.38      | 0.30   |                 |         |                   |

1 Two magnet wires may be terminated in the same terminal slot if diameters are equal.  
2 Single magnet wire only.

187 Box Tab Terminals

Material

Tin plated brass

Typical Cavity Size 1

(See page 23)

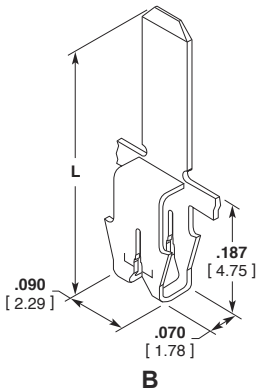

| Type                                    | Copper Magnet Wire Range <sup>1</sup> |           | Dim. L      | Tab Size    | Stock Thickness |           | Strip Part Number |
|-----------------------------------------|---------------------------------------|-----------|-------------|-------------|-----------------|-----------|-------------------|
|                                         | AWG                                   | mm        |             |             | Tab Section     | Mag Wire  |                   |
| B<br>187 Box<br>Standard IDC<br>F-Crimp | 30-28                                 | 0.25-0.32 | .432        | .110 x .020 | .020            | .012      | 63702-1           |
|                                         |                                       |           | 10.97       | 2.79 x 0.51 | 0.51            | 0.30      |                   |
|                                         | 29-27                                 | 0.29-0.36 | .432        | .110 x .020 | .020            | .012      | 1217196-1         |
|                                         |                                       |           | 10.97       | 2.79 x 0.51 | 0.51            | 0.30      |                   |
|                                         | 30-28                                 | 0.25-0.32 | .512        | .110 x .020 | .020            | .012      | 160810-2          |
|                                         |                                       |           | 13.00       | 2.79 x 0.51 | 0.51            | 0.30      |                   |
|                                         | 27-25                                 | 0.25-0.32 | .512        | .110 x .020 | .020            | .012      | 160809-2          |
|                                         |                                       |           | 13.00       | 2.79 x 0.51 | 0.51            | 0.30      |                   |
|                                         | 24-22                                 | 0.25-0.32 | .512        | .110 x .020 | .020            | .012      | 160897-2          |
|                                         |                                       |           | 13.00       | 2.79 x 0.51 | 0.51            | 0.30      |                   |
| 30                                      | 0.25                                  | .550      | .071 x .025 | .025        | .012            | 1217405-1 |                   |
|                                         |                                       | 14.00     | 1.80 x 0.63 | 0.63        | 0.30            |           |                   |
| 29-27                                   | 0.29-0.36                             | .700      | .059 x .032 | .032        | .012            | 1742605-1 |                   |
|                                         |                                       | 17.78     | 1.50 x 0.81 | 0.81        | 0.30            |           |                   |
| 25-22 <sup>2</sup>                      | 0.46-0.64                             | .700      | .059 x .032 | .032        | .012            | 1217013-1 |                   |
|                                         |                                       | 17.78     | 1.50 x 0.81 | 0.81        | 0.30            |           |                   |

1 Two magnet wires may be terminated in the same terminal if diameters are equal.  
2 Single magnet wire only.

Standard MAG-MATE Terminals

Standard MAG-MATE Terminals (Continued)

300 Box Tab Terminals

Material

Tin plated brass

Typical Cavity Size 2

(See page 23)



| Type                                         | Copper Magnet Wire Range <sup>1</sup> |      | Dim. L | Tab Size    | Stock Thickness |          | Strip Part Number      |
|----------------------------------------------|---------------------------------------|------|--------|-------------|-----------------|----------|------------------------|
|                                              | AWG                                   | mm   |        |             | Tab Section     | Mag Wire |                        |
| A<br>300 Box<br>Standard IDC<br>Straight Tab | 20                                    | 0.79 | .750   | .063 x .025 | .025            | .016     | 63965-1 <sup>2</sup>   |
|                                              |                                       |      | 19.05  | 1.60 x 0.63 | 0.63            | 0.41     |                        |
|                                              | 31                                    | 0.23 | .895   | .063 x .025 | .025            | .016     | 1217595-1 <sup>2</sup> |
|                                              |                                       |      | 22.73  | 1.60 x 0.63 | 0.63            | 0.41     |                        |
|                                              |                                       |      | .870   | .062 x .032 | .032            | .010     | 63810-1                |
|                                              |                                       |      | 22.10  | 1.57 x 0.81 | 0.81            | 0.25     |                        |

1 Two magnet wires may be terminated in the same terminal slot if diameters are equal.  
2 Tinsel wire only.

Typical Cavity Size 2  
when "C" dimension is .120[3.05]  
(See page 23)  
Typical Cavity Size 6  
when "C" dimension is .070[1.78]  
(See page 23)

| Type                                        | Copper Magnet Wire Range <sup>1</sup> |           | Dim. C      | Tab Size    | Stock Thickness |          | Strip Part Number |
|---------------------------------------------|---------------------------------------|-----------|-------------|-------------|-----------------|----------|-------------------|
|                                             | AWG                                   | mm        |             |             | Tab Section     | Mag Wire |                   |
| B<br>300 Box<br>Standard IDC<br>Twisted Tab | 33-31                                 | 0.18-0.23 | .070        | .125 x .020 | .020            | .012     | 63806-1           |
|                                             |                                       |           | 1.78        | 3.17 x 0.51 | 0.51            | 0.30     |                   |
|                                             | 31-28                                 | 0.23-0.32 | .070        | .125 x .020 | .020            | .012     | 63807-1           |
|                                             |                                       |           | 1.78        | 3.17 x 0.51 | 0.51            | 0.30     |                   |
|                                             | 27-24                                 | 0.36-0.50 | .070        | .125 x .020 | .020            | .012     | 63808-1           |
|                                             |                                       | 1.78      | 3.17 x 0.51 | 0.51        | 0.30            |          |                   |
|                                             | 21 <sup>2</sup>                       | 0.72      | .120        | .118 x .030 | .030            | .016     | 63463-1           |
|                                             |                                       |           | 3.05        | 3.00 x 0.76 | 0.76            | 0.41     |                   |
|                                             | 19.5 <sup>2</sup>                     | 0.86      | .120        | .118 x .030 | .030            | .016     | 63216-1           |
|                                             |                                       |           | 3.05        | 3.00 x 0.76 | 0.76            | 0.41     |                   |

1 Two magnet wires may be terminated in the same terminal slot if diameters are equal.  
2 Single magnet wire only.

Material

Tin plated brass

Typical Cavity Size 2

(See page 23)

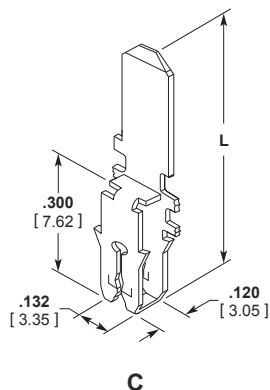

| Type                                      | Copper Magnet Wire Range <sup>1</sup> |           | Dim. L      | Tab Size    | Stock Thickness |          | Strip Part Number |
|-------------------------------------------|---------------------------------------|-----------|-------------|-------------|-----------------|----------|-------------------|
|                                           | AWG                                   | mm        |             |             | Tab Section     | Mag Wire |                   |
| C<br>300 Box<br>Standard IDC<br>Timer Tab | 33-31                                 | 0.18-0.23 | .585        | .118 x .020 | .020            | .010     | 1217746-1         |
|                                           |                                       |           | 14.86       | 3.00 x 0.51 | 0.51            | 0.25     |                   |
|                                           | 30 -28                                | 0.25-0.32 | .585        | .118 x .020 | .020            | .010     | 1217745-1         |
|                                           |                                       |           | 14.86       | 3.00 x 0.51 | 0.51            | 0.25     |                   |
|                                           | 27-23                                 | 0.36-0.57 | .585        | .118 x .020 | .020            | .016     | 63973-1           |
|                                           |                                       |           | 14.86       | 3.00 x 0.51 | 0.51            | 0.41     |                   |
|                                           |                                       |           | .585        | .125 x .020 | .020            | .016     | 63489-1           |
|                                           |                                       |           | 14.86       | 3.17 x 0.51 | 0.51            | 0.41     |                   |
|                                           | 25-22 <sup>2</sup>                    | 0.45-0.64 | .585        | .118 x .020 | .020            | .016     | 1217596-1         |
|                                           |                                       |           | 14.86       | 3.00 x 0.51 | 0.51            | 0.41     |                   |
|                                           | 23.5-21.5 <sup>2</sup>                | 0.54-0.68 | .585        | .118 x .020 | .020            | .016     | 1217593-1         |
|                                           |                                       |           | 14.86       | 3.00 x 0.51 | 0.51            | 0.41     |                   |
|                                           | 27-23                                 | 0.36-0.57 | .775        | .125 x .020 | .020            | .016     | 1742167-1         |
|                                           |                                       |           | 19.68       | 3.17 x 0.51 | 0.51            | 0.41     |                   |
| 23-20 <sup>2</sup>                        | 0.57-0.81                             | .775      | .125 x .020 | .020        | .016            | 63899-1  |                   |
|                                           |                                       | 19.68     | 3.17 x 0.51 | 0.51        | 0.41            |          |                   |
| 19-17 <sup>2</sup>                        | 0.91-1.15                             | .585      | .118 x .020 | .020        | .016            | 63972-1  |                   |
|                                           |                                       | 14.86     | 3.00 x 0.51 | 0.51        | 0.41            |          |                   |
| 18 Lead                                   | 1.02                                  | .585      | .118 x .020 | .020        | .016            | 63974-1  |                   |
|                                           |                                       | 14.86     | 3.00 x 0.51 | 0.51        | 0.41            |          |                   |

1 Two magnet wires may be terminated in the same terminal slot if diameters are equal.  
2 Single magnet wire only; 22 AWG [0.64 mm] or larger.

Standard MAG-MATE Terminals (Continued)

Pin Receptacle Terminals

Material

A: Tin plated brass  
 B: Unplated brass

Typical Cavity Size 2  
 (See page 23)

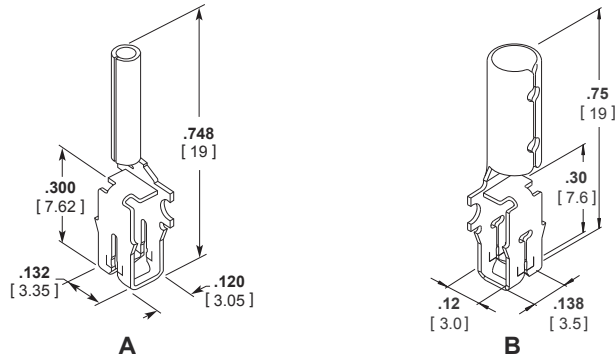

| Type                   | Copper Magnet Wire Range <sup>1</sup> |           | Mating Pin Dia. | Stock Thickness | Strip Part Number |
|------------------------|---------------------------------------|-----------|-----------------|-----------------|-------------------|
|                        | AWG                                   | mm        |                 |                 |                   |
| A<br>Pin<br>Receptacle | 30-27                                 | 0.25-0.36 | .079<br>2.00    | .013<br>0.32    | 1394403-1         |
|                        | 26-23                                 | 0.40-0.57 | .079<br>2.00    | .013<br>0.32    | 1394475-1         |
|                        | 21-18 <sup>2</sup>                    | 0.72-1.00 | .079<br>2.00    | .013<br>0.32    | 1394476-1         |
|                        | 26-23                                 | 0.40-0.57 | .150<br>3.80    | .013<br>0.32    | 1394638-1         |
|                        | 21-18 <sup>2</sup>                    | 0.72-1.00 | .150<br>3.80    | .013<br>0.32    | 1394639-1         |
| B<br>Pin<br>Receptacle | 30-27                                 | 0.25-0.36 | .150<br>3.80    | .013<br>0.32    | 1740417-1         |
|                        | 26-23                                 | 0.40-0.57 | .150<br>3.80    | .013<br>0.32    | 1740418-1         |
|                        | 21-18 <sup>3</sup>                    | 0.72-1.00 | .150<br>3.80    | .013<br>0.32    | 1740419-1         |

1 Two magnet wires may be terminated in the same terminal slot if diameters are equal.  
 2 Single magnet wire only; 20.5 AWG [0.76 mm] or larger.  
 3 Single magnet wire only

Standard MAG-MATE  
Terminals

Standard MAG-MATE Terminals (Continued)

Pin I/O Terminals

Material

Tin plated brass

**.300 [7.62] Series Box**

Styles A, B and C

Typical Cavity Size 2

(See page 23)

**.500 [12.7] Series Box**

Style D

Typical Cavity Size 4

(See page 23)



A



B

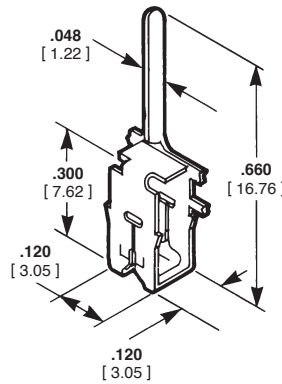

C



D

| Type                            | Copper Magnet Wire Range <sup>1</sup> |           | Pin Dia.     | Stock Thickness |              | Strip Part Number |
|---------------------------------|---------------------------------------|-----------|--------------|-----------------|--------------|-------------------|
|                                 | AWG                                   | mm        |              | I/O             | Mag Wire     |                   |
| A<br>300 Box<br>Straight Pin    | 27-23                                 | 0.36-0.57 | .060<br>1.52 | .010<br>0.25    | .010<br>0.25 | 63722-1           |
| B<br>300 Box<br>Offset Pin-R.H. | 33-31                                 | 0.18-0.23 | .048<br>1.22 | .010<br>0.25    | .010<br>0.25 | 63443-1           |
|                                 | 33-31                                 | 0.18-0.23 | .048<br>1.22 | .010<br>0.25    | .010<br>0.25 | 63444-1           |
| C<br>300 Box<br>Offset Pin-L.H. | 31-28                                 | 0.23-0.32 | .048<br>1.22 | .010<br>0.25    | .010<br>0.25 | 63569-1           |
|                                 | 27-23                                 | 0.36-0.57 | .048<br>1.22 | .010<br>0.25    | .016<br>0.25 | 63570-1           |
|                                 | 25-22 <sup>2</sup>                    | 0.45-0.64 | .048<br>1.22 | .010<br>0.25    | .016<br>0.41 | 63788-1           |
| D<br>500 Box<br>Straight Pin    | 27-23                                 | 0.86-1.15 | .090<br>2.29 | .016<br>0.41    | .016<br>0.41 | 63278-1           |
|                                 | 22-20                                 | 0.64-0.81 | .090<br>2.29 | .016<br>0.41    | .016<br>0.41 | 63277-1           |

<sup>1</sup> Two magnet wires may be terminated in the same terminal slot if diameters are equal.

<sup>2</sup> Single magnet wire only; 22 AWG [0.64 mm] or larger.



Standard MAG-MATE Terminals (Continued)

110 Series  
FASTON Tab Terminals

Material

Tin plated brass

Typical Cavity Size 2

(See page 23)

Note: .110 [2.79] Tab Terminals

mate with compatible

FASTON receptacles.

Request Catalog 82004.

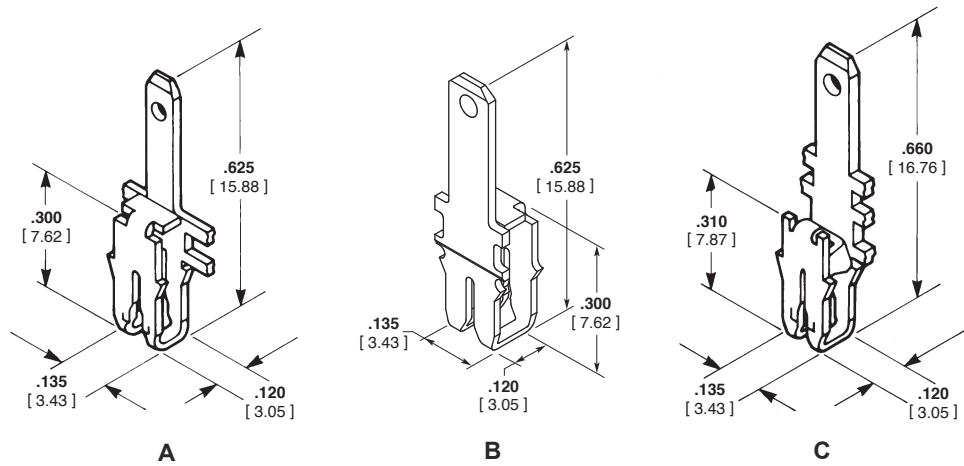

| Type                                                                  | Copper Magnet Wire Range <sup>1</sup> |           | Tab Size                   | Stock Thickness |              | Strip Part Number |
|-----------------------------------------------------------------------|---------------------------------------|-----------|----------------------------|-----------------|--------------|-------------------|
|                                                                       | AWG                                   | mm        |                            | Tab             | Mag Wire     |                   |
| A <sup>4</sup><br>300 Box<br>Standard IDC<br>.110[2.79]<br>FASTON Tab | 30-27                                 | 0.25-0.36 | .110 x .020<br>2.79 x 0.51 | .020<br>0.51    | .012<br>0.30 | 63777-1           |
|                                                                       | 27-23                                 | 0.36-0.57 | .110 x .020<br>2.79 x 0.51 | .020<br>0.51    | .016<br>0.41 | 63746-1           |
|                                                                       | 23-20 <sup>2</sup>                    | 0.45-0.64 | .110 x .020<br>2.79 x 0.51 | .020<br>0.51    | .016<br>0.41 | 63486-1           |
| B <sup>4,5</sup><br>300 Box<br>Single IDC w/<br>Strain Relief Slot    | 19-17                                 | 0.91-1.15 | .110 x .020<br>2.79 x 0.51 | .020<br>0.51    | .020<br>0.51 | 63145-1           |
|                                                                       | 27-23                                 | 0.36-0.57 | .110 x .020<br>2.79 x 0.51 | .020<br>0.51    | .016<br>0.41 | 63827-1           |
| C <sup>3,4</sup><br>Poke-In<br>Combination Tab                        | 3.5-20 <sup>2</sup>                   | 0.54-0.81 | .110 x .020<br>2.79 x 0.51 | .020<br>0.51    | .016<br>0.41 | 1217783-1         |
|                                                                       | 28-24                                 | 0.32-0.51 | .110 x .020<br>2.79 x 0.51 | .020<br>0.51    | .012<br>0.30 | 63062-1           |
|                                                                       | 25-22 <sup>2</sup>                    | 0.45-0.64 | .110 x .020<br>2.79 x 0.51 | .020<br>0.51    | .012<br>0.30 | 63063-2           |

1 Two magnet wires may be terminated in the same terminal slot if diameters are equal.

2 Single magnet wire only; 22 AWG [0.64 mm] or larger.

3 Poke-In feature accepts 20-18 AWG [0.5-0.8 mm<sup>2</sup>] Solid or overcoated stranded lead wire or 90° Poke-In tab.

4 After insertion into plastic cavity, tab portion must be bent over 45°-90° or potted in to prevent pullout when mating receptacle is disconnected.

5 Strain relief slot for high vibration applications.

**Standard MAG-MATE Terminals (Continued)**

**187 Series FASTON Tab Terminals**

**Material**

Tin plated brass

**Typical Cavity Size**

(See page 23)

Type A—Cavity Size 2

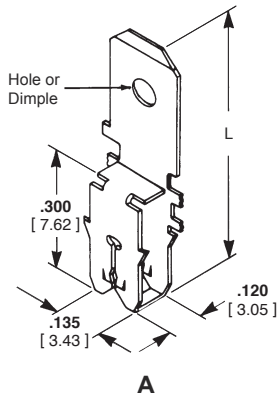

A<sup>3</sup>  
300 Box  
Standard IDC  
.187 [4.75]  
FASTON  
Tab

| Type               | Copper Magnet Wire Range <sup>1</sup> |               | Dim. L        | Tab Feature | Tab Size                   | Stock Thickness |                   | Strip Part Number      |
|--------------------|---------------------------------------|---------------|---------------|-------------|----------------------------|-----------------|-------------------|------------------------|
|                    | AWG                                   | mm            |               |             |                            | Tab Section     | Mag. Wire Section |                        |
| 33-31              | 0.18-0.23                             | .630<br>16.00 | .630<br>16.00 | Dimple      | .187 x .020<br>4.75 x 0.51 | .020<br>0.51    | .010<br>0.25      | 62513-1*               |
|                    |                                       |               |               | Hole        | .187 x .020<br>4.75 x 0.51 | .020<br>0.51    | .012<br>0.30      | 63584-1                |
| 30-27              | 0.25-0.36                             | .630<br>16.00 | .630<br>16.00 | Dimple      | .187 x .020<br>4.75 x 0.51 | .020<br>0.51    | .012<br>0.30      | 62512-1*               |
|                    |                                       |               |               | Dimple      | .187 x .032<br>4.75 x 0.81 | .032<br>0.81    | .012<br>0.30      | 62678-1†*              |
| 27-23              | 0.36-0.57                             | .630<br>16.00 | .630<br>16.00 | Dimple      | .187 x .020<br>4.75 x 0.51 | .020<br>0.51    | .016<br>0.41      | 62514-1*               |
|                    |                                       |               |               | Hole        | .187 x .020<br>4.75 x 0.51 | .020<br>0.51    | .016<br>0.41      | 63664-1                |
| 23                 | 0.57                                  | .630<br>16.00 | .630<br>16.00 | —           | .187 x .020<br>4.75 x 0.51 | .020<br>0.51    | .016<br>0.41      | 63776-1                |
|                    |                                       |               |               | Hole        | .187 x .020<br>4.75 x 0.51 | .020<br>0.51    | .016<br>0.41      | 63585-1                |
| 22-20 <sup>2</sup> | 0.64-0.81                             | .630<br>16.00 | .630<br>16.00 | Dimple      | .187 x .020<br>4.75 x 0.51 | .020<br>0.51    | .016<br>0.41      | 62511-1*               |
|                    |                                       |               |               | Hole        | .187 x .020<br>4.75 x 0.51 | .020<br>0.51    | .016<br>0.41      | 63663-1                |
| 20-18 <sup>2</sup> | 0.81-1.02                             | .630<br>16.00 | .630<br>16.00 | Dimple      | .187 x .032<br>4.75 x 0.81 | .032<br>0.81    | .016<br>0.41      | 1217065-1              |
|                    |                                       |               |               | Hole        | .187 x .032<br>4.75 x 0.81 | .032<br>0.81    | .016<br>0.41      | 1217128-1              |
| 19-17              | 0.91-1.15                             | .630<br>16.00 | .630<br>16.00 | Dimple      | .187 x .020<br>4.75 x 0.51 | .020<br>0.51    | .020<br>0.51      | 62904-1 <sup>4</sup>   |
|                    |                                       |               |               | Hole        | .187 x .020<br>4.75 x 0.51 | .020<br>0.51    | .020<br>0.51      | 63670-1                |
| 19-17              | 0.91-1.15                             | .630<br>16.00 | .630<br>16.00 | Dimple      | .187 x .020<br>4.75 x 0.51 | .020<br>0.51    | .020<br>0.51      | 63273-1 <sup>2</sup>   |
|                    |                                       |               |               | Hole        | .187 x .020<br>4.75 x 0.51 | .020<br>0.51    | .020<br>0.51      | 1742160-1 <sup>1</sup> |

**187 Series Combination Poke-In FASTON Terminals**

**Material**

Tin plated brass

**Typical Cavity Size**

(See page 23)

Type B—Cavity Size 2

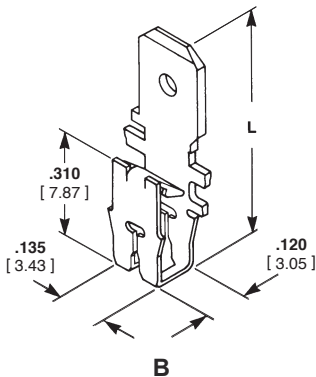

B<sup>3,4</sup>  
Poke-In  
Combination  
Tab

| Type               | Copper Magnet Wire Range <sup>1</sup> |               | Dim. L        | Tab Feature | Tab Size                   | Stock Thickness |                   | Strip Part Number      |
|--------------------|---------------------------------------|---------------|---------------|-------------|----------------------------|-----------------|-------------------|------------------------|
|                    | AWG                                   | mm            |               |             |                            | Tab Section     | Mag. Wire Section |                        |
| 33-31              | 0.81-0.23                             | .630<br>16.00 | .630<br>16.00 | Hole        | .187 x .020<br>4.75 x 0.51 | .020<br>0.51    | .010<br>0.25      | 63018-1                |
| 27-22 <sup>2</sup> | 0.35-0.63                             | .630<br>16.00 | .630<br>16.00 | w/o Hole    | .187 x .020<br>4.75 x 0.51 | .020<br>0.51    | .016<br>0.41      | 316300-4<br>2-316300-7 |
| 22-19 <sup>2</sup> | 0.64-0.89                             | .630<br>16.00 | .630<br>16.00 | w/o Hole    | .187 x .020<br>4.75 x 0.51 | .020<br>0.51    | .016<br>0.41      | 316300-5<br>2-316300-8 |
| 19-17 <sup>2</sup> | 0.90-1.15                             | .630<br>16.00 | .630<br>16.00 | w/o Hole    | .187 x .020<br>4.75 x 0.51 | .020<br>0.51    | .016<br>0.41      | 316300-6<br>2-316300-9 |
| 17-16 <sup>2</sup> | 1.20-1.30                             | .630<br>16.00 | .630<br>16.00 | Hole        | .187 x .020<br>4.75 x 0.51 | .020<br>0.51    | .016<br>0.41      | 6-316300-7             |

- 1 Two magnet wires may be terminated in the same terminal slot if diameters are equal.
- 2 Single magnet wire only.
- 3 Poke-In feature accepts 20-18 AWG [0.5-0.8 mm<sup>2</sup>] solid, fused stranded lead wire or 90° poke-in tab terminal.
- 4 After insertion into plastic cavity, tab portion must be bent over 45°-90° or potted in to prevent pullout when mating receptacle is disconnected.

**Note:** 187 [4.75] Tab Terminals mate with compatible FASTON receptacles. Request Catalog 82004.

Chart continued on next page

Standard MAG-MATE Terminals (Continued)

187 Series  
FASTON Tab Terminals

(Continued)

Material

Tin plated brass

Typical Cavity Size

(See page 23)

Type A—Cavity Size 5

Type B—Cavity Size 5



| Type                                                                 | Copper Magnet Wire Range <sup>1</sup> |                           | Dim. L        | Tab Feature | Tab Size                   | Stock Thickness |                   | Strip Part Number |
|----------------------------------------------------------------------|---------------------------------------|---------------------------|---------------|-------------|----------------------------|-----------------|-------------------|-------------------|
|                                                                      | AWG                                   | mm                        |               |             |                            | Tab Section     | Mag. Wire Section |                   |
| A<br>300 Box<br>Standard IDC<br>Narrow Body<br>Latch Type            | 33-31                                 | 0.18-0.23                 | .630<br>16.00 | Dimple      | .187 x .020<br>4.75 x 0.51 | .020<br>0.51    | .010<br>0.25      | 63108-1†          |
|                                                                      | 31-28                                 | 0.23-0.32                 | .630<br>16.00 | Dimple      | .187 x .020<br>4.75 x 0.51 | .020<br>0.51    | .010<br>0.25      | 62743-1†          |
|                                                                      | 30-27                                 | 0.25-0.36                 | .630<br>16.00 | Dimple      | .187 x .020<br>4.75 x 0.51 | .020<br>0.51    | .012<br>0.30      | 63109-1†          |
|                                                                      | 27-23                                 | 0.36-0.57                 | .630<br>16.00 | Dimple      | .187 x .020<br>4.75 x 0.51 | .020<br>0.51    | .016<br>0.41      | 63107-1           |
|                                                                      |                                       |                           |               | Dimple      | .187 x .020<br>4.75 x 0.51 | .020<br>0.51    | .016<br>0.41      | 1217493-1         |
|                                                                      | 23-20 <sup>2</sup>                    | 0.57-0.81                 | .630<br>16.00 | Dimple      | .187 x .020<br>4.75 x 0.51 | .020<br>0.51    | .016<br>0.41      | 63340-1           |
|                                                                      | 22-20 <sup>2</sup>                    | 0.64-0.81                 | .630<br>16.00 | Dimple      | .187 x .020<br>4.75 x 0.51 | .020<br>0.51    | .016<br>0.41      | 63429-1           |
|                                                                      | 19-17 <sup>2</sup>                    | 0.91-1.15                 | .630<br>16.00 | Dimple      | .187 x .020<br>4.75 x 0.51 | .020<br>0.51    | .016<br>0.41      | 62888-1           |
|                                                                      |                                       |                           |               | Hole        | .187 x .020<br>4.75 x 0.51 | .020<br>0.51    | .016<br>0.41      | 63782-1           |
|                                                                      | 18 lead <sup>2</sup>                  | 0.80-0.92 mm <sup>2</sup> | .630<br>16.00 | —           | .187 x .020<br>4.75 x 0.51 | .020<br>0.51    | .016<br>0.41      | 1217592-1†        |
| B <sup>3</sup><br>Narrow Body<br>Latch Type w/<br>Strain Relief Slot | 23.5-20 <sup>2</sup>                  | 0.54-0.81                 | .630<br>16.00 | Dimple      | .187 x .020<br>4.75 x 0.51 | .020<br>0.51    | .016<br>0.41      | 1217004-1         |

1 Two magnet wires may be terminated in the same terminal slot if diameters are equal.  
 2 Single magnet wire only; 22 AWG [0.64 mm] or larger.  
 3 Strain relief slot for high vibration applications.  
 † These part numbers are available upon special request; contact TE Engineering for details.

Standard MAG-MATE Terminals

Chart continued on next page

**Standard MAG-MATE Terminals (Continued)**

**187 Series  
FASTON Tab Terminals**

(Continued)

**Material**

Tin plated brass

**Typical Cavity Size**

(See page 23)

Type A—Cavity Size 4

Type B—Cavity Size 4



**A**



**B**

| Type                                      | Copper Magnet Wire Range <sup>1</sup>                              |               | Dim. L        | Tab Feature                | Tab Size                   | Stock Thickness            |                   | Strip Part Number |           |
|-------------------------------------------|--------------------------------------------------------------------|---------------|---------------|----------------------------|----------------------------|----------------------------|-------------------|-------------------|-----------|
|                                           | AWG                                                                | mm            |               |                            |                            | Tab Section                | Mag. Wire Section |                   |           |
| A <sup>3</sup><br>500 Box<br>Standard IDC | 22-20                                                              | 0.64-0.81     | .830<br>21.08 | Hole                       | .187 x .020<br>4.75 x 0.51 | .020<br>0.51               | .020<br>0.51      | 1742819-1         |           |
|                                           | 19-17                                                              | 0.91-1.15     | .830<br>21.08 | Hole                       | .187 x .020<br>4.75 x 0.51 | .020<br>0.51               | .020<br>0.51      | 1742820-1         |           |
|                                           | 17.5-16                                                            | 1.09-1.29     | .830<br>21.08 | Hole                       | .187 x .020<br>4.75 x 0.51 | .020<br>0.51               | .020<br>0.51      | 63667-1           |           |
|                                           |                                                                    |               |               | Hole                       | .187 x .020<br>4.75 x 0.51 | .020<br>0.51               | .020<br>0.51      | 63427-1           |           |
|                                           | 16-15                                                              | 1.29-1.45     | .830<br>21.08 | Hole                       | .187 x .020<br>4.75 x 0.51 | .020<br>0.51               | .020<br>0.51      | 63762-1           |           |
|                                           |                                                                    |               |               | Dimple                     | .187 x .020<br>4.75 x 0.51 | .020<br>0.51               | .020<br>0.51      | 63353-1           |           |
|                                           | 14.5-13 <sup>2</sup>                                               | 1.54-1.83     | .830<br>21.08 | Hole                       | .187 x .020<br>4.75 x 0.51 | .020<br>0.51               | .020<br>0.51      | 1217902-1         |           |
|                                           | B <sup>3,4</sup><br>500 Box<br>Single IDC w/<br>Strain Relief Slot | 27-23         | 0.36-0.57     | .830<br>21.08              | Hole                       | .187 x .020<br>4.75 x 0.51 | .020<br>0.51      | .020<br>0.51      | 1217042-1 |
|                                           |                                                                    | 22-20         | 0.64-0.81     | .830<br>21.08              | Hole                       | .187 x .020<br>4.75 x 0.51 | .020<br>0.51      | .020<br>0.51      | 63983-1   |
|                                           |                                                                    |               |               |                            | Hole                       | .187 x .032<br>4.75 x 0.81 | .032<br>0.81      | .020<br>0.51      | 1217339-1 |
| 19-17                                     |                                                                    | 0.91-1.15     | .830<br>21.08 | Hole                       | .187 x .020<br>4.75 x 0.51 | .020<br>0.51               | .020<br>0.51      | 63995-1           |           |
|                                           |                                                                    |               |               | Hole                       | .187 x .032<br>4.75 x 0.81 | .032<br>0.81               | .020<br>0.51      | 1217090-1         |           |
| 16-15                                     | 1.29-1.45                                                          | .830<br>21.08 | Hole          | .187 x .020<br>4.75 x 0.51 | .020<br>0.51               | .020<br>0.51               | 63996-1           |                   |           |

1 Two magnet wires may be terminated in the same terminal slot if diameters are equal.

2 Single magnet wire only.

3 After insertion into plastic cavity, tab portion must be bent over 45°-90° or potted in to prevent pullout when mating receptacle is disconnected.

4 Strain relief slot for high vibration applications.

Standard MAG-MATE Terminals (Continued)

250 Series  
FASTON Tab Terminals

Material

Tin plated brass

Typical Cavity Size

(See page 23)

Type A—Cavity Size 2

Type B—Cavity Size 5

Type C—Cavity Size 3

Note: .250 [6.35] tab terminals mate with compatible FASTON receptacles. Request Catalog 82004.



| Type                                                          | Copper Magnet Wire Range <sup>1</sup> |                        | Dim. L        | Tab Feature    | Tab Size                   | Stock Thickness |                   | Strip Part Number  |
|---------------------------------------------------------------|---------------------------------------|------------------------|---------------|----------------|----------------------------|-----------------|-------------------|--------------------|
|                                                               | AWG                                   | mm                     |               |                |                            | Tab Section     | Mag. Wire Section |                    |
| A <sup>3</sup><br>300 Box Standard IDC .250 [6.35] FASTON Tab | 33-31                                 | 0.18-0.23              | .750<br>19.05 | Dimple         | .250 x .032<br>6.35 x 0.81 | .032<br>0.81    | .010<br>0.25      | 62600-1*           |
|                                                               | 30-27                                 | 0.25-0.36              | .750<br>19.05 | Dimple         | .250 x .032<br>6.35 x 0.81 | .032<br>0.81    | .012<br>0.30      | 62651-1*           |
|                                                               | 28-24                                 | 0.32-0.51              | .750<br>19.05 | Hole           | .250 x .032<br>6.35 x 0.81 | .032<br>0.81    | .016<br>0.41      | 63607-1            |
|                                                               | 27-23                                 | 0.36-0.57              | .750<br>19.05 | Dimple         | .250 x .032<br>6.35 x 0.81 | .032<br>0.81    | .016<br>0.41      | 62652-1*           |
|                                                               | 22-20                                 | 0.64-0.81              | .750<br>19.05 | Dimple         | .250 x .032<br>6.35 x 0.81 | .032<br>0.81    | .016<br>0.41      | 1217924-1          |
| B<br>Narrow Body Latch Type                                   | 19-17                                 | 0.91-1.15              | .750<br>19.05 | Dimple         | .250 x .032<br>6.35 x 0.81 | .032<br>0.81    | .020<br>0.51      | 1742398-1          |
|                                                               | 33-31                                 | 0.18-0.23 <sup>1</sup> | .750<br>19.05 | Dimple         | .250 x .032<br>6.35 x 0.81 | .032<br>0.81    | .010<br>0.25      | 63026-1            |
|                                                               | 30-27                                 | 0.25-0.36 <sup>1</sup> | .750<br>19.05 | Dimple         | .250 x .032<br>6.35 x 0.81 | .032<br>0.81    | .012<br>0.30      | 63027-1            |
|                                                               | 27-23                                 | 0.36-0.57              | .750<br>19.05 | Dimple         | .250 x .032<br>6.35 x 0.81 | .032<br>0.81    | .016<br>0.41      | 1217860-1          |
|                                                               | 23-20 <sup>2</sup>                    | 0.57-0.81              | .750<br>19.05 | Dimple         | .250 x .032<br>6.35 x 0.81 | .032<br>0.81    | .016<br>0.41      | 1217870-1          |
| C<br>Wide Body Latch Type                                     | 33-31                                 | 0.18-0.23              | .750<br>19.05 | Hole           | .250 x .032<br>6.35 x 0.81 | .032<br>0.81    | .010<br>0.25      | 63309-1            |
|                                                               | 31-28                                 | 0.23-0.32              | .750<br>19.05 | Dimple         | .250 x .032<br>6.35 x 0.81 | .032<br>0.81    | .012<br>0.30      | 63403-2            |
|                                                               | 30-28                                 | 0.25-0.32              | .750<br>19.05 | Hole           | .250 x .032<br>6.35 x 0.81 | .032<br>0.81    | .012<br>0.30      | 1217152-1          |
|                                                               | 30-27                                 | 0.25-0.36              | .750<br>19.05 | Dimple<br>Hole | .250 x .032<br>6.35 x 0.81 | .032<br>0.81    | .012<br>0.30      | 63132-1<br>63499-1 |
|                                                               | 27-23                                 | 0.36-0.57              | .750<br>19.05 | Hole<br>Dimple | .250 x .032<br>6.35 x 0.81 | .032<br>0.81    | .016<br>0.41      | 63571-1<br>63128-1 |
|                                                               | 22-20 <sup>2</sup>                    | 0.64-0.81              | .750<br>19.05 | Dimple         | .250 x .032<br>6.35 x 0.81 | .032<br>0.81    | .016<br>0.41      | 63601-2            |
|                                                               | 19-17 <sup>2</sup>                    | 0.91-1.15              | .750<br>19.05 | Hole           | .250 x .032<br>6.35 x 0.81 | .032<br>0.81    | .016<br>0.41      | 63614-1            |

1 Two magnet wires may be terminated in the same terminal slot if diameters are equal.  
 2 Single magnet wire only; 22 AWG [0.64 mm] or larger.  
 3 After insertion into plastic holder, tab portion must be bent over 45°-90° or potted in to prevent pullout when mating receptacle is disconnected.

\* Recognized under the Component Program of Underwriters Laboratories, Inc.

Standard MAG-MATE Terminals

Chart continued on next page

**Standard MAG-MATE Terminals (Continued)**

**250 Series  
FASTON Tab Terminals**

(Continued)

**Material**

Tin plated brass

**Typical Cavity Size**

(See page 23)

Type A—Cavity Size 4

Type B—Cavity Size 4

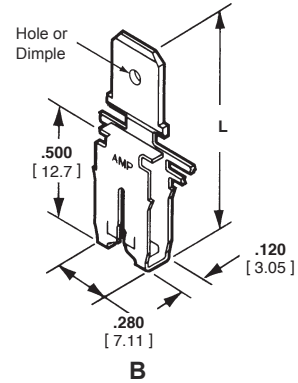
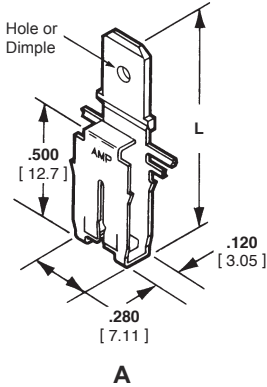

| Type                                                     | Copper Magnet Wire Range <sup>1</sup> |           | Dim. L        | Tab Feature | Tab Size                   | Stock Thickness |                   | Strip Part Number |
|----------------------------------------------------------|---------------------------------------|-----------|---------------|-------------|----------------------------|-----------------|-------------------|-------------------|
|                                                          | AWG                                   | mm        |               |             |                            | Tab Section     | Mag. Wire Section |                   |
| A <sup>3</sup><br>500 Box<br>Standard IDC<br>Wide Neck   | 22-20                                 | 0.64-0.81 | .952<br>24.18 | Hole        | .250 x .032<br>6.35 x 0.81 | .032<br>0.81    | .020<br>0.51      | 63495-1           |
|                                                          | 19-17                                 | 0.91-1.15 | .952<br>24.18 | Hole        | .250 x .032<br>6.35 x 0.81 | .032<br>0.81    | .020<br>0.51      | 63464-3           |
|                                                          | 16-15                                 | 1.29-1.45 | .952<br>24.18 | Hole        | .250 x .032<br>6.35 x 0.81 | .032<br>0.81    | .020<br>0.51      | 63459-2           |
|                                                          | 14-13 <sup>2</sup>                    | 1.61-1.83 | .952<br>24.18 | Dimple      | .250 x .032<br>6.35 x 0.81 | .032<br>0.81    | .020<br>0.51      | 63460-1           |
|                                                          |                                       |           |               | Hole        | .250 x .032<br>6.35 x 0.81 | .032<br>0.81    | .020<br>0.51      | 63816-1           |
| B <sup>3</sup><br>500 Box<br>Standard IDC<br>Narrow Neck | 22-20                                 | 0.64-0.81 | .952<br>24.18 | Dimple      | .250 x .032<br>6.35 x 0.81 | .032<br>0.81    | .020<br>0.51      | 63155-1           |
|                                                          | 19-17                                 | 0.91-1.15 | .952<br>24.18 | Dimple      | .250 x .032<br>6.35 x 0.81 | .032<br>0.81    | .020<br>0.51      | 62923-1           |
|                                                          | 16-15                                 | 1.29-1.45 | .952<br>24.18 | Dimple      | .250 x .032<br>6.35 x 0.81 | .032<br>0.81    | .020<br>0.51      | 63064-1           |
|                                                          | 14-13 <sup>2</sup>                    | 1.61-1.83 | .952<br>24.18 | Dimple      | .250 x .032<br>6.35 x 0.81 | .032<br>0.81    | .020<br>0.51      | 63465-1           |
|                                                          | 12 <sup>2</sup>                       | 2.05      | .952<br>24.18 | Dimple      | .250 x .032<br>6.35 x 0.81 | .032<br>0.81    | .020<br>0.51      | 63425-1           |

<sup>1</sup> Two magnet wires may be terminated in the same terminal slot if diameters are equal.

<sup>2</sup> Single magnet wire only.

<sup>3</sup> After insertion into plastic holder, tab portion must be bent over 45°-90° or potted in to prevent pullout when mating receptacle is disconnected.



Standard MAG-MATE Terminals (Continued)

Typical Plastic Cavity

Illustrations shown are for reference only. They are not a purchased item. Manufacture only according to TE Specification.

Technical Documents

**Application Specifications** describe requirements for using the product in its intended application and or crimping information. They are intended for the Packaging and Design Engineer and the Machine Setup Person.

- 114-2050 —Poke-In Tab MAG-MATE Terminals
- 114-2069 —Standard MAG-MATE .187 [4.75] Box Height Terminals
- 114-2046 —Standard MAG-MATE .300 [7.62] Box Height Terminals
- 114-2066 —Standard MAG-MATE .500 [12.7] Box Height Terminals
- 114-2067 —Standard MAG-MATE .300 [7.62] Box Height Latch-In Terminals Narrow Body
- 114-2094 —Standard MAG-MATE .300 [7.62] Box Height Latch-In Terminals Wide Body

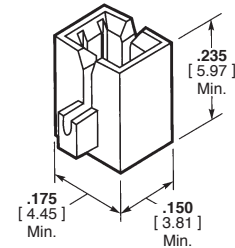

Cavity Size 1  
 .187 [4.75] Box  
 MAG-MATE  
 (Application Spec. 114-2069)

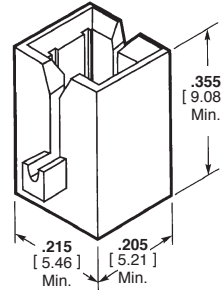

Cavity Size 2  
 .300 [7.62] Box  
 MAG-MATE  
 (Application Spec. 114-2046)

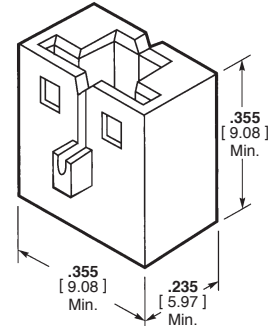

Cavity Size 3  
 .300 [7.62] Box  
 Latch-In MAG-MATE Wide Body  
 (Application Spec. 114-2094)



Cavity Size 4  
 .500 [12.70] Box  
 MAG-MATE  
 (Application Spec. 114-2066)

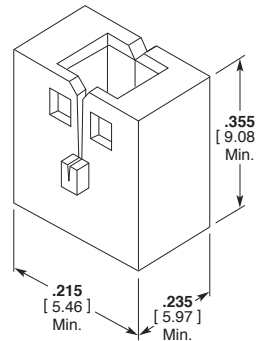

Cavity Size 5  
 .300 [7.62] Box  
 Latch-In MAG-MATE,  
 Narrow Body  
 (Application Spec. 114-2067)

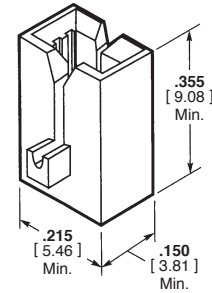

Cavity Size 6  
 .300 [7.62] Box  
 MAG-MATE  
 (Application Spec. 114-2046)

**Note:** The MAG-MATE typical plastic cavities shown above are for reference only. They are not a purchased item. Refer to appropriate TE application specification for details.

Plastic cavities, designed to TE specifications, may be molded as part of the coil bobbin or attached to a lamination stack in the area of the magnet wire coil. Each cavity is a rectangular box with two narrow slots on opposing walls and a plastic post or anvil extending upward from the bottom surface. During or after the winding process, the magnet wire is placed across the plastic cavities and into the slots, either manually or by coil winding equipment.

Unraveling is prevented by a slight friction fit, suitable bend or by wrapping the magnet wire around a tie-off post.

During insertion, two insulation displacing terminal slots strip the film insulation from the magnet wire producing a stable electrical termination.

The plastic anvil supports the magnet wire, helping to prevent it from being dragged down when the terminal is inserted.

Terminal retention is secured in the plastic cavities by either locking barbs or locking latches in addition to locking barbs for quick disconnect FASTON tab terminals.

Excess magnet wire is trimmed flush with the outside of the plastic cavity by a shear blade traveling with the terminal insertion ram.

The sheared wire end can be tucked inside the plastic cavity, if necessary, by cutting the wire off before the terminal is fully seated allowing the terminal to drag the severed end of the wire into the pocket inside the cavity.

**TE will provide design and mold engineering resources to manufacture any specifically designed MAG-MATE cavity housing.**

**Standard MAG-MATE Terminals (Continued)**

**Typical Plastic Cavities**

Illustrations shown are for reference only. They are not a purchased item. Manufacture only according to TE Specification.



Slim Line MAG - MATE  
Reference Application  
Spec. 114-2147



Mini MAG - MATE  
Reference Application  
Spec. 114-2047

**Technical Documents  
Application Specifications**

describe requirements for using the product in its intended application and or crimping information. They are intended for the Packaging and Design Engineer and the Machine Setup Person.

114-2140—Slim Line  
MAG-MATE  
Terminals

**Technical Documents  
Application Specifications**

describe requirements for using the product in its intended application and or crimping information. They are intended for the Packaging and Design Engineer and the Machine Setup Person.

114-2047—Mini MAG-MATE  
Terminals

### Slim Line MAG-MATE Terminals

**Product Facts**

- Terminates all magnet wire film insulations
- Eliminates need for pre-stripping conductors
- Eliminates need to post-insulate terminations
- Excess magnet wire is automatically trimmed during the termination process
- 187 and 250 Series Faston Tab and posted PCB Tab terminals available
- Terminates 33-17 AWG [0.18-1.15 mm ] magnet wire
- Simultaneously terminates two magnet wires of the same size in one terminal from 33-23 AWG [0.18-0.57 mm ]
- Available in strip form for semi-automatic or fully automatic insertions
- High speed, fully automated integrated systems provide uniform terminations reliably at the lowest possible applied cost
- Clean metal-to-metal interface produces stable, gas-tight electrical terminations free of oxides and other contaminants
- Recognized under the Component Recognition Program of Underwriters Laboratories Inc., File No. E13288 

**Applications**

- Motor windings and connections
- Coil Connections
- Transformer windings and connections
- Bobbin connections
- Lighting Ballasts
- Power Supplies



TE offers a full selection of 187 and 250 Series Faston and posted PCB Slim Line MAG-MATE Tab insulation displacement (IDC) terminals for magnet wire terminations.

Slim Line MAG-MATE terminals with a single IDC slot terminate 33-17 AWG [0.18 to 1.15 mm].

Each IDC slot terminates a range of up to four consecutive magnet wire sizes.

Two magnet wires with the same diameter can be terminated in one terminal. Except as noted.

MAG-MATE cavities are either integrated into coil bodies or especially designed cavity housings. The magnet wires are precisely positioned in the plastic cavity slots.

The MAG-MATE Inserter cuts the terminals from the strip and places the terminals over the magnet wire into the plastic cavities.

During this operation, small stripping shoulders in the IDC slot remove the film insulation from the magnet wire.

Wiping action between the wire and terminals removes oxides or other contaminants present on both the conductor and the terminal slot side walls, producing a clean, stable, gas-tight electrical termination.

Residual spring energy in the terminal causes the side walls of each IDC slot to function as opposing cantilever beams.

This constant pressure results in an intimate metal-to-metal interface, providing a reliable, long-term connection.

The MAG-MATE Inserter may be used as a semi-automatic bench machine or integrated in production lines for fully-automatic applications.

Slim Line MAG-MATE Terminals

**Slim Line MAG-MATE Terminals** (Continued)

**187 Series FASTON Tab Terminals**

**Material**

Tin plated brass



| Type               | Copper Magnet Wire Range <sup>1</sup> |      | Dim. L | Tab Feature | Tab Size    | Stock Thickness |                  | Strip Part Number |
|--------------------|---------------------------------------|------|--------|-------------|-------------|-----------------|------------------|-------------------|
|                    | AWG                                   | mm   |        |             |             | Tab Section     | Mag.Wire Section |                   |
| 33-31              | 0.18-0.23                             | .630 | 16.00  | Hole        | .187 x .020 | .020            | .012             | 63710-2           |
|                    |                                       |      |        | Dimple      | 4.75 x 0.51 | .051            | 0.30             | 63738-2           |
| 30-28              | 0.25-0.32                             | .630 | 16.00  | Hole        | .187 x .032 | .032            | .012             | 63711-2           |
|                    |                                       |      |        | Dimple      | 4.75 x 0.51 | .051            | 0.30             | 63737-2           |
| 27-24              | 0.36-0.51                             | .630 | 16.00  | Hole        | .187 x .020 | .020            | .016             | 63712-2           |
|                    |                                       |      |        | Dimple      | 4.75 x 0.51 | .051            | 0.41             | 63736-2           |
| 23-20 <sup>2</sup> | 0.57-0.81                             | .760 | 19.31  | Plain       | .187 x .020 | .020            | .016             | 1217497-1         |
|                    |                                       |      |        | Dimple      | 4.75 x 0.51 | .051            | 0.41             |                   |
| 19-17 <sup>2</sup> | 0.91-1.15                             | .630 | 16.00  | Hole        | .187 x .020 | .020            | .016             | 63713-2           |
|                    |                                       |      |        | Dimple      | 4.75 x 0.51 | .051            | 0.41             | 63735-2           |
| 19-17 <sup>2</sup> | 0.91-1.15                             | .630 | 16.00  | Hole        | .187 x .032 | .032            | .016             | 1217516-1         |
|                    |                                       |      |        | Dimple      | 4.75 x 0.51 | .051            | 0.41             | 63714-2           |
| 19-17 <sup>2</sup> | 0.91-1.15                             | .630 | 16.00  | Hole        | .187 x .020 | .020            | .016             | 63714-2           |
|                    |                                       |      |        | Dimple      | 4.75 x 0.51 | .051            | 0.41             | 63734-2           |

1 Two magnet wires may be terminated in the same terminal slot if diameters are equal.  
2 Single magnet wire only; 22 AWG [0.64] or larger.

**250 Series FASTON Tab Terminals**

**Material**

Tin plated brass



| Type               | Copper Magnet Wire Range <sup>1</sup> |      | Dim. L | Tab Feature | Tab Size    | Stock Thickness |                  | Strip Part Number |
|--------------------|---------------------------------------|------|--------|-------------|-------------|-----------------|------------------|-------------------|
|                    | AWG                                   | mm   |        |             |             | Tab Section     | Mag.Wire Section |                   |
| 33-31              | 0.18-0.23                             | .752 | 19.10  | Hole        | .250 x .032 | .032            | .012             | 63716-2           |
|                    |                                       |      |        | Dimple      | 6.35 x 0.81 | 0.81            | 0.30             | 63744-2           |
| 30-28              | 0.25-0.32                             | .752 | 19.10  | Hole        | .250 x .032 | .032            | .012             | 63717-2           |
|                    |                                       |      |        | Dimple      | 6.35 x 0.81 | 0.81            | 0.30             | 63743-2           |
| 27-24              | 0.36-0.51                             | .752 | 19.10  | Hole        | .250 x .032 | .032            | .016             | 63718-2           |
|                    |                                       |      |        | Dimple      | 6.35 x 0.81 | 0.81            | 0.41             | 63742-2           |
| 23-20 <sup>2</sup> | 0.57-0.81                             | .752 | 19.10  | Hole        | .250 x .032 | .032            | .016             | 63719-2           |
|                    |                                       |      |        | Dimple      | 6.35 x 0.81 | 0.81            | 0.41             | 63741-2           |
| 19-17 <sup>2</sup> | 0.91-1.15                             | .752 | 19.10  | Hole        | .250 x .032 | .032            | .016             | 63720-2           |
|                    |                                       |      |        | Dimple      | 6.35 x 0.81 | 0.81            | 0.41             | 63740-2           |

1 Two magnet wires may be terminated in the same terminal slot if diameters are equal.  
2 Single magnet wire only; 22 AWG [0.64] or larger.

**Posted PCB SOLDER Terminal**

**Material**

Tin plated brass

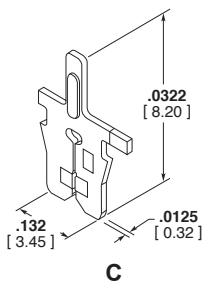

| Type      | Copper Magnet Wire Range <sup>1</sup> |      | Dim. L | Tab Feature | Tab Size    | Stock Thickness |                  | Strip Part Number |
|-----------|---------------------------------------|------|--------|-------------|-------------|-----------------|------------------|-------------------|
|           | AWG                                   | mm   |        |             |             | Tab Section     | Mag.Wire Section |                   |
| 33.5-30   | 0.17-0.25                             | .323 | 8.20   | Embossment  | .040 x .024 | .024            | .013             | 1534684-1         |
|           |                                       |      |        |             |             | 1.00 x 0.60     | 0.60             |                   |
| 29.5-26   | 0.27-0.40                             | .323 | 8.20   | Embossment  | .040 x .024 | .024            | .013             | 1534685-1         |
|           |                                       |      |        |             |             | 1.00 x 0.60     | 0.60             |                   |
| 26-22     | 0.40-0.63                             | .323 | 8.20   | Embossment  | .040 x .024 | .024            | .013             | 1534686-1         |
|           |                                       |      |        |             |             | 1.00 x 0.60     | 0.60             |                   |
| 22-20     | 0.63-0.81                             | .323 | 8.20   | Embossment  | .040 x .024 | .024            | .013             | 1740829-1         |
|           |                                       |      |        |             |             | 1.00 x 0.60     | 0.60             |                   |
| 21.5-19.5 | 0.67-0.85                             | .323 | 8.20   | Embossment  | .040 x .024 | .024            | .013             | 1534687-1         |
|           |                                       |      |        |             |             | 1.00 x 0.60     | 0.60             |                   |

1 Two magnet wires may be terminated in the same terminal slot if diameters are equal.  
2 Single magnet wire only; 22 AWG [0.64] or larger.

**Slim Line MAG-MATE Terminals** (Continued)

**Offset Tab Terminals**

**Material**

Tin Plated Brass

Applications where I/O Tab spacing must be less than IDC connection spacing

Example: automotive accessory coils



**A**

| Type                            | Copper Magnet Wire Range <sup>1</sup> |           | Dim. L        | Diode Size   | Tab Size                   | Stock Thickness |                  | Strip Part Number |
|---------------------------------|---------------------------------------|-----------|---------------|--------------|----------------------------|-----------------|------------------|-------------------|
|                                 | AWG                                   | mm        |               |              |                            | Tab Section     | Mag.Wire Section |                   |
| A<br>Combination Diode Slot/Tab | 33-31                                 | 0.18-0.23 | .725<br>18.42 | #20<br>0.8   | .059 x .032<br>1.50 x 0.81 | 0.032<br>0.81   | 0.012<br>0.30    | 63888-1           |
|                                 | 33-31                                 | 0.18-0.23 | .725<br>18.42 | #22.5<br>0.6 | .059 x .032<br>1.50 x 0.81 | 0.032<br>0.81   | 0.012<br>0.30    | 63903-1           |

<sup>1</sup> Two magnet wires may be terminated in the same terminal slot if diameters are equal.

**Posted PCB Terminals**

**Multi-Spring Solderless Terminal**

**Material**

Tin Plated Copper Alloy

**Cavity Size**

Application Spec.

Contact TE Engineering

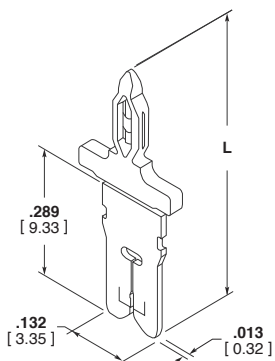

**B**

| Type                                          | Copper Magnet Wire Range <sup>1</sup> |            | Dim. L        | Stock Thickness |                  | Strip Part Number |
|-----------------------------------------------|---------------------------------------|------------|---------------|-----------------|------------------|-------------------|
|                                               | AWG                                   | mm         |               | Tab Section     | Mag.Wire Section |                   |
| B<br>Multi-Spring Solderless PCB Tab Terminal | 33-29.5                               | 0.18-0.265 | .583<br>14.80 | .031<br>0.81    | .013<br>0.32     | 2120743-2         |
|                                               | 29.5-26                               | 0.265-0.40 | .583<br>14.80 | .031<br>0.81    | .013<br>0.32     | 2120744-2         |
|                                               | 26-22.5                               | 0.40-0.63  | .583<br>14.80 | .031<br>0.81    | .013<br>0.32     | 2120745-2         |
|                                               | 22.5-19.5 <sup>2</sup>                | 0.63-0.85  | .583<br>14.80 | .031<br>0.81    | .013<br>0.32     | 2120746-2         |
|                                               | 19.5-17 <sup>2</sup>                  | 0.85-1.12  | .583<br>14.80 | .031<br>0.81    | .013<br>0.32     | 2120747-2         |

<sup>1</sup> Two magnet wires may be terminated in the same terminal slot if diameters are equal.

<sup>2</sup> Single magnet wire only. 22 awg [0.63 mm] and larger.

**Note:** PC Board hole size .057 [1.45]

**Slim Line MAG-MATE Terminals** (Continued)

**Posted PCB  
Solder Terminals**

**Material**

Unplated brass

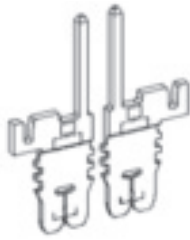

A

| Type                                       | Copper Magnet Wire Range |                        | Stock Thickness  | Strip Part Number |
|--------------------------------------------|--------------------------|------------------------|------------------|-------------------|
|                                            | AWG                      | mm                     |                  |                   |
| A<br>MAG-MATE<br>Terminal<br>with MQS Pins | 33-30                    | 0.256-0.40             | Varied thickness | 1-1987222-1       |
|                                            | 33 <sup>1</sup>          | 0.40-0.56 <sup>1</sup> |                  |                   |
|                                            | 30-26                    | 0.256-0.40             | Varied thickness | 1-1987223-1       |
|                                            | 30-26 <sup>1</sup>       | 0.40-0.56 <sup>1</sup> |                  |                   |
|                                            | 26-22                    | 0.40-0.63              | Varied thickness | 1-1987224-1       |
|                                            | 26-23 <sup>1</sup>       | 0.40-0.56 <sup>1</sup> |                  |                   |
|                                            | 22-20                    | 0.63-0.80              | Varied thickness | 1-1987225-1       |
|                                            | 20-17                    | 0.85-1.12              | Varied thickness | 1-1987226-1       |

<sup>1</sup> For double magnet wires



### Mini MAG-MATE Terminals

#### Product Facts

- Terminates all fine gauge magnet wire film insulations
- Eliminates need to pre-strip conductors
- Eliminates need to post insulate terminations
- Terminates 52-30 AWG [0.02-0.25 mm] diameter copper magnet wire
- Poke-In leaf style accepts 22 -18 AWG [0.3-0.9 mm] overcoated stranded or solid lead wire
- Available in strip form for semi-automatic or fully automatic insertions
- High speed, fully automated integrated systems provide uniform terminations and reliability at the lowest possible applied cost
- Recognized under the Component Recognition Program of Underwriters Laboratories Inc, File No. E13288



#### Applications

- Ignition coils
- Small motors
- Synchronist timers
- Electric meter coils
- Solenoids
- Relays



TE offers Mini MAG-MATE poke-in, crimp wire barrel, post and quick disconnect tab insulation displacement (IDC) terminals for fine gauge magnet wire terminations.

Mini MAG-MATE terminals are designed to terminate 52-30 AWG [0.02-0.25 mm] diameter copper magnet wire.

Poke-in leaf terminals accept 22-18 AWG [0.3-0.9 mm<sup>2</sup>] overcoated stranded or solid lead wire.

The terminal design uses the AMPLIVAR serrated burr technology to penetrate the film insulation of copper magnet wire.

Mini MAG-MATE cavity pockets, designed to TE specifications, include a wire

receiving slot and wire tie-off post that is either integrated into coil bodies or specially designed cavity housings.

The magnet wire is wrapped around the tie-off post and placed across the cavity slot. After the coil is wound, the finish end of the magnet wire is dressed through the second cavity slot and tied to its tie-off post.

The Mini MAG-MATE Inserter shears the terminal from the carrier strip and inserts the terminal into the cavity by a dual ram insertion mechanism.

As the unexpanded terminal approaches the bottom of the cavity, the upper ram stops. The lower ram continues to push to a prescribed depth to expand the terminal and complete

the termination process.

The fully seated terminal fits squarely into the cavity, while the serrated leg of the terminal cams against the pre-positioned magnet wire to penetrate the film insulation and provide a stable electrical termination.



**Mini MAG-MATE Terminals (Continued)**



**Poke-In Terminal**

**Material**

.010 [0.25] tin plated brass

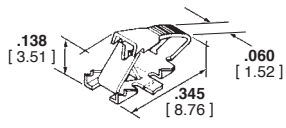

**A**

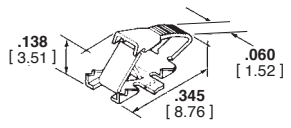

**B**



**C**

| Type                      | Copper Magnet Wire Range |           | Lead Wire Range <sup>1</sup> |                 | Mating Tab                 | Stock Thickness |               | Strip Part Number    |
|---------------------------|--------------------------|-----------|------------------------------|-----------------|----------------------------|-----------------|---------------|----------------------|
|                           | AWG                      | mm        | AWG                          | mm <sup>2</sup> |                            | Poke-In Beam    | Mag Wire      |                      |
| A<br>Lead Wire<br>Poke-In | 52-42                    | 0.02-0.06 | 22-18                        | 0.3-0.9         | —                          | 0.010<br>0.25   | 0.010<br>0.25 | 62781-1              |
|                           | 44-36                    | 0.05-0.13 | 22-18                        | 0.3-0.9         | —                          | 0.010<br>0.25   | 0.010<br>0.25 | 62780-1              |
|                           | 38-30                    | 0.10-0.25 | 22-18                        | 0.3-0.9         | —                          | 0.010<br>0.25   | 0.010<br>0.25 | 62606-1              |
| B<br>Tab<br>Poke-In       | 52-42                    | 0.02-0.06 | —                            | —               | .060 x .020<br>1.52 x 0.51 | 0.010<br>0.25   | 0.010<br>0.25 | 63613-1              |
|                           | 44-36                    | 0.05-0.13 | —                            | —               | .060 x .020<br>1.52 x 0.51 | 0.010<br>0.25   | 0.010<br>0.25 | 63795-1 <sup>2</sup> |
|                           | 38-30                    | 0.10-0.25 | —                            | —               | .060 x .020<br>1.52 x 0.51 | 0.010<br>0.25   | 0.010<br>0.25 | 63844-2 <sup>2</sup> |
| C<br>Skinny Mini          | 40-34.5                  | 0.08-0.15 | —                            | —               | .040 x .020<br>1.00 x 0.51 | 0.010<br>0.25   | 0.010<br>0.25 | 1718165-1            |

<sup>1</sup> Solid or overcoated stranded lead wire only.  
<sup>2</sup> Radius on beam leaf tip.

**Mini MAG-MATE Terminals** (Continued)

**Posted Terminal**

**Material**

Tin over premilled brass



**A**

| Type          | Copper Magnet Wire Range |           | Post Size                  | Stock Thickness |               | Strip Part Number |
|---------------|--------------------------|-----------|----------------------------|-----------------|---------------|-------------------|
|               | AWG                      | mm        |                            | Post            | Mag Wire      |                   |
| A<br>PCB Post | 38-30                    | 0.10-0.25 | .024 x .020<br>0.62 x 0.51 | 0.020<br>0.51   | 0.010<br>0.25 | 63675-4           |

**FASTON Tab Terminals**

**Material**

Tin over premilled brass



**B**

| Type                           | Copper Magnet Wire Range |   |           |   | Tab Size                   | Stock Thickness |              | Strip Part Number |
|--------------------------------|--------------------------|---|-----------|---|----------------------------|-----------------|--------------|-------------------|
|                                | G                        | W | A         | m |                            | Post            | Mag Wire     |                   |
| B<br>.187 [4.75]<br>FASTON Tab | 44-36                    |   | 0.05-0.13 |   | .187 x .020<br>4.75 x 0.51 | .020<br>0.51    | .010<br>0.25 | 63778-1           |
|                                | 38-30                    |   | 0.10-0.25 |   | .187 x .020<br>4.75 x 0.51 | .020<br>0.51    | .010<br>0.25 | 1217529-1         |

**Crimp Wire Barrel Terminal**

**Material**

Tin plated brass



**C**

| Type                   | Copper Magnet Wire Range |           | Lead Wire Range |                 | Stock Thickness |               | Strip Part Number    |
|------------------------|--------------------------|-----------|-----------------|-----------------|-----------------|---------------|----------------------|
|                        | AWG                      | mm        | AWG             | mm <sup>2</sup> | Crimp Barrel    | Mag Wire      |                      |
| C<br>Crimp Wire Barrel | 38-30                    | 0.10-0.25 | 22-18           | 0.3-0.9         | 0.010<br>0.25   | 0.010<br>0.25 | 63199-1 <sup>1</sup> |

<sup>1</sup> Wire and insulation barrel reversed so lead wire exits over magnet wire termination area.

## SIAMEZE Terminals

### Product Facts

- Terminates all copper magnet wire film insulations
- Eliminates need for pre-stripping conductors
- Moving Beam contact design connects a wide range of magnet wire sizes with a single terminal
- Standard range terminals connect 34-18 AWG [0.16-1.0 mm] magnet wire
- Fine range terminals connect 36-27 AWG [0.13-0.38 mm] magnet wire
- Medium range terminals connect 23-12 AWG [0.56-2.03 mm] magnet wire
- Excess magnet wire is automatically trimmed during the termination process
- Available in strip form for semi-automatic or fully automatic insertions
- Loose piece terminals available for manual tool insertions
- High-speed automatic coil winding machine terminations provide uniform reliability at the lowest possible applied cost
- Clean metal-to-metal interface produces stable, gas-tight electrical terminations free of oxides and other contaminants
- Recognized under the Component Program of Underwriters Laboratories Inc., File No. E13288



### Applications

- Motor windings and connections
- Coil connections
- Transformer windings and connections
- Ballasts
- Power supplies
- Solenoids
- Actuators

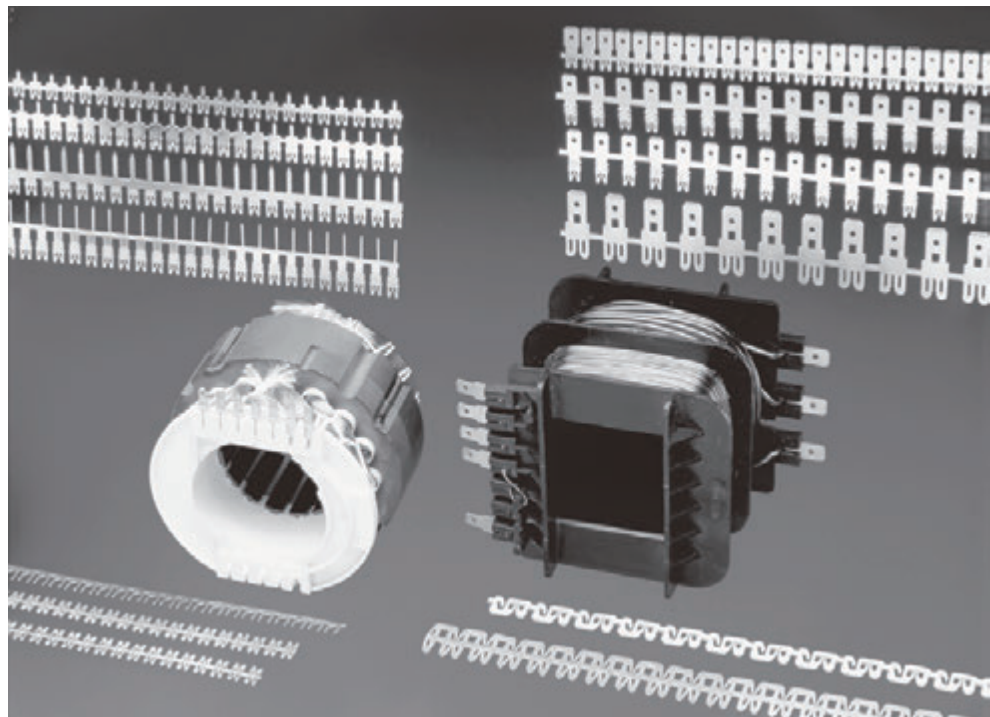

TE offers a full selection of SIAMEZE insulation displacement (IDC) terminals for interconnecting copper magnet wires, lead wires, and other components.

The SIAMEZE insulation displacement (IDC) terminal technology eliminates the need to strip the film insulation from copper magnet wires and lead wires.

Terminals are available in wire-to-wire, Lead Lok, quick disconnect tabs, posts, pin and receptacle terminals.



Available with either Moving Beam contacts whereby a single terminal connects to a very wide range of magnet wire sizes, or a Compliant Beam for contacting two magnet wires of the same diameter in one terminal for splicing or bi-filar applications.

Tab terminals are available with single barbs or multiple retention barbs for higher retention.

According to TE specifications SIAMEZE cavities are either integrated into coil bodies or specially designed cavity housings.

The magnet wires are positioned in the "U" shaped slots.

The SIAMEZE terminal Inserter cuts the terminals from the strip and places the terminals over the magnet wire into the plastic cavities.

During this operation the small stripping devices penetrate the film insulation from the magnet wire.

Residual spring energy in the terminal causes the side walls of the IDC slot to function as opposing cantilever beams.

This constant pressure results in an intimate metal-to-metal interface, providing a reliable, long-term connection.

The wiping action between the wire and terminals remove all oxides or other contaminants present on both the conductor and the terminal slot side walls, producing a clean, stable, gas-tight electrical termination.

The SIAMEZE terminal Inserter may be used as a semi-automatic bench machine or integrated in production lines for fully-automatic applications.

**SIAMEZE Terminals** (Continued)

**Lead Lok Terminals**

**Product Facts**

- Provides perpendicular and parallel lead wire strain relief retention forces in excess of 20 lbs (90 N).
- Inserter automatically positions and secures lead wire during insertion
- Manual, semi-automated, fully automated systems allow for lead wire termination
- Accepts #18 - #22 [0.3mm 2-0.8 mm<sup>2</sup>] AWG solid or stranded lead wire with .115 [2.92 ] max.insulation diameter
- No lead wire stripping required



SIAMEZE Terminals

TE features the Lead Lok strain relief terminal system that provides optimum lead wire retention when used in conjunction with SIAMEZE insulation displacement terminals. After the one-step insertion of SIAMEZE wire-to-wire terminals into TE specified plastic cavities, the application is ready for the secondary lead wire attachment. The lead wire is manually positioned over the magnet wire terminated SIAMEZE wire-to-wire terminal. The Lead Lok Inserter

cuts the Lead Lok terminals from the strip and places the terminal over the lead wire in the plastic cavities. During this operation, the lead wire is automatically seated, the insulation pierced and the exposed solid or stranded conductor is terminated in the IDC slot of the SIAMEZE wire-to-wire terminal. Residual spring energy in the terminal causes the side walls of the IDC slot to function as opposing cantilever beams. This constant pressure results in an intimate

metal-to-metal interface, providing a reliable, long-term connection. Perpendicular and parallel lead wire strain relief retention forces in excess of 20 lbs are achieved. The Lead Lok Inserter may be a secondary station in the SIAMEZE Wire-to-Wire semi-automatic bench machine. Information regarding terminal insertion equipment may be found in Magnet Wire Termination Overview #138516.

**TECHNICAL DOCUMENTS**

Cavity Specifications - Provide dimensional design guidelines & criteria for a cavity to be used with a SIAMEZE IDC terminal. The appropriate Cavity Specification number is shown on the following pages adjacent to the terminal number. As a general reference, overall dimensions are shown at the end of this section.

- **Product Specifications** ( These describe the performance characteristics and verification tests )
  - 108-2085 Standard Range SIAMEZE Insulation Displacement
  - 108-2293 High Temperature Standard Range SIAMEZE Insulation Displacement
  - 108-2244 Fine Range SIAMEZE Insulation Displacement
  - 108-2239 Medium Range SIAMEZE Insulation Displacement
  - 108-2316 Heavy Range SIAMEZE Insulation Displacement
- **Application Specifications** ( These describe the requirements for using the product in its intended application )
  - 114-13166 Standard and Fine Range SIAMEZE Insulation Displacement
  - 114-13210 Medium and Heavy Range SIAMEZE Insulation Displacement

Dimensions are in inches and millimeters unless otherwise specified. Values in brackets are metric equivalents.

Dimensions are shown for reference purposes only. Specifications subject to change.

**SIAMEZE Terminals** (Continued)

**SIAMEZE Interconnection System**

**How the System Operates**

① **Magnet Wire**

The magnet wire is positioned in “U” slot manually or automatically by coil winding equipment.

② **Terminal Insertion Finger**

The terminal insertion finger is part of the SIAMEZE Inserter. It pushes the terminal that was sheared from the carrier strip through the “tube” into the cavity.

③ **Contact**

Various wire attachments in standard, fine, medium and heavy duty terminals are available (See tables).

④ **IDC Slot**

The IDC slot in the terminal will terminate a wide range of magnet wire sizes.

⑤ **Stripping Burrs**

During the insertion process, these burrs strip the film insulation from the magnet wire.

⑥ **Retention Barbs**

Terminal retention is provided in the cavity by single or multiple locking barbs.

**Test Results**

SIAMEZE products have been submitted to the following tests without significant millivolt increase:

⑦ **Plastic Cavity**

Design must comply with TE connectivity specifications (for cavity drawing numbers see tables). **Consulting TE is required for design in.**

⑧ **Cavity Slot for Wire**

The width has to be in accordance with the wire size (see cavity drawings).

⑨ **Wire Cutoff Block**

The wire cutoff block supports the magnet wire during the trimming process. The magnet wire is cut plain to the cavity front side.

⑩ **Trim Blade**

The trim blade cuts the excess magnet wire and the wire cutoff block at the front of the cavity.

⑪ **Terminal Insertion Complete**

The magnet wire termination is complete when the terminal is fully seated in the cavity.

**Current Cycling—**

250 cycles with each cycle consisting of 15 minutes “ON” followed by 15 minutes “OFF”

**Thermal Shock—**

25 Cycles -40°C to +125°C,  
25 Cycles -40°C to +175°C  
for High Temperature terminals

**Humidity—**

**Temperature Cycling**

10 cycles between 25°C and 65°C at 80 to 100% RH

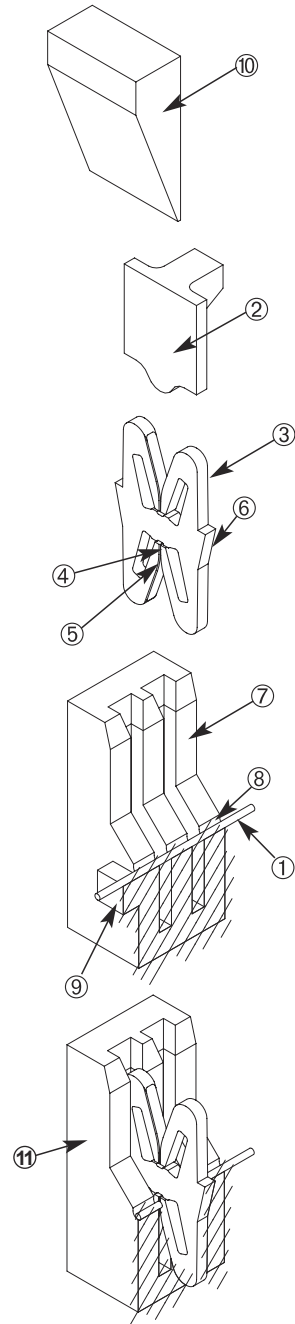



**SIAMEZE Terminals** (Continued)

**Lead Lok Interconnection System**

**How the System Operates**

- ① **Lead Lok Insertion Finger**  
The Lead Lok insertion finger pushes the Lead Lok that was sheared from the carrier strip and positions the Lead Lok and lead wire into the IDC slot.
- ② **Lead Lok Terminal**  
The Lead Lok terminal provides maximum lead wire retention in the cavity.
- ③ **Retention Barbs**  
The Lead Lok multiple barbs provide retention in the cavity.
- ④ **Lead Wire**  
Stranded, solid and bonded lead wire with 105°C PVC insulation can be used. Contact TE Engineering for other lead wires and insulation under consideration.
- ⑤ **IDC Slot**  
The IDC slot will pierce the lead wire during insertion.
- ⑥ **Lead Wire Insertion Complete**  
The lead wire termination is complete when the Lead Lok is fully seated in the cavity.

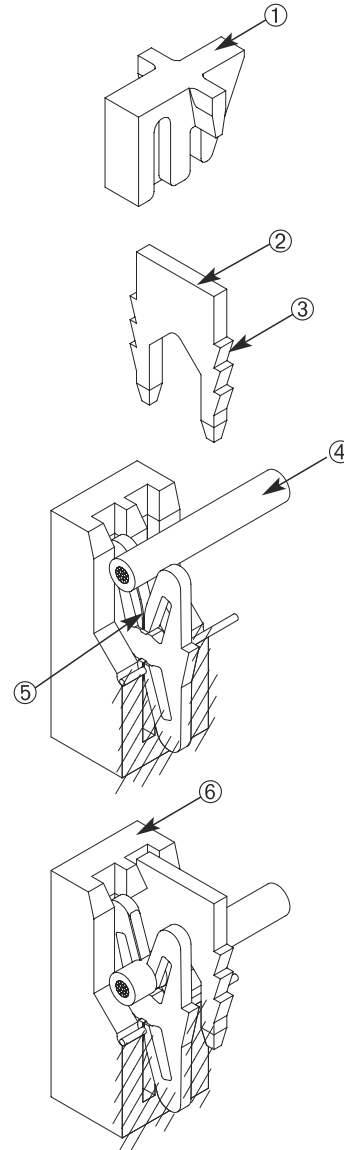

**HOW TO CONNECT MULTIPLE MAGNET WIRES OR OTHER COMPONENTS**

- ① **Bussed High Carrier Terminals**  
Bridging of two SIAMEZE terminals that is accomplished by leaving the carrier strip between two adjacent terminals intact.
- ② **Bussed High Carry SIAMEZE Plastic Cavity**  
Bussed cavity pocket designs are available for double or triple bussed terminals.
- ③ **Magnet Wire**  
Magnet wire may be equal or differ in size for bi-filar applications.

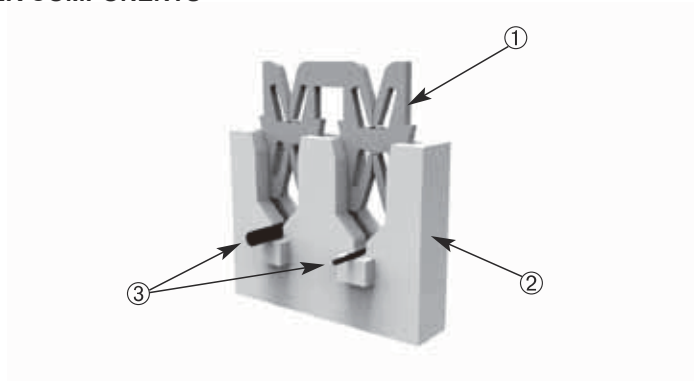

**SIAMEZE Terminals**

**SIAMEZE Terminals (Continued)**

**Wire-to-Wire Terminals**

**Material**  
Brass



| Type                                    | Recommended Pocket <sup>7</sup> | Copper Magnet Wire Range |           | Lead Wire Range    |                 | Part Number                           |                                                                                  |
|-----------------------------------------|---------------------------------|--------------------------|-----------|--------------------|-----------------|---------------------------------------|----------------------------------------------------------------------------------|
|                                         |                                 | AWG                      | mm        | AWG                | mm <sup>2</sup> | Reeled                                | Loose                                                                            |
| A<br>Moving Beam                        | 1601421                         | 18-34                    | 1.02-0.16 | 18-22 <sup>6</sup> | 0.8-0.3         | 1601000-1<br>1601000-2 <sup>5</sup>   | 4-1601000-1 <sup>2</sup><br>4-1601000-2 <sup>2,5</sup>                           |
|                                         |                                 | 27-36                    | 0.36-0.13 | 18-22 <sup>6</sup> | 0.8-0.3         | 1601117-1<br>2-1601117-1 <sup>1</sup> | 4-1601117-1 <sup>2</sup>                                                         |
| B<br>Wire Specific <sup>8</sup>         | 1601421                         | 18-34                    | 1.02-0.16 | 20                 | 0.5             | 1601056-1<br>2-1601056-1 <sup>1</sup> | 4-1601056-1 <sup>2</sup>                                                         |
|                                         |                                 | 18-34                    | 1.02-0.16 | 18                 | 0.8             | 1601074-1<br>2-1601074-1 <sup>1</sup> | 4-1601074-1 <sup>2</sup>                                                         |
| C<br>High Carrier                       | 1601433<br>1601440              | 18-34                    | 1.02-0.16 | 18-22 <sup>6</sup> | 0.8-0.3         | 1601046-1<br>2-1601046-1 <sup>1</sup> | 4-1601046-1 <sup>2</sup><br>6-1601046-1 <sup>3</sup><br>8-1601046-1 <sup>4</sup> |
|                                         |                                 |                          |           |                    |                 | 1601237-1<br>2-1601237-1 <sup>1</sup> | 4-1601237-1 <sup>2</sup><br>6-1601237-1 <sup>3</sup>                             |
| D<br>High Carrier Specific <sup>8</sup> | 1601433                         | 27-36                    | 0.36-0.13 | 20                 | 0.5             | 1601136-1<br>2-1601136-1 <sup>1</sup> | 4-1601136-1 <sup>2</sup><br>6-1601136-1 <sup>3</sup>                             |
| E<br>Medium Range                       | 1601436                         | 12-23                    | 2.06-0.56 | 16-20              | 1.3-0.5         | 1601140-1<br>2-1601140-1 <sup>1</sup> | 4-1601140-1 <sup>2</sup><br>6-1601140-1 <sup>3</sup>                             |
| F<br>Lead Lok                           | 1601421                         |                          |           | 18-22              | 0.8-0.3         | 1601140-1<br>2-1601140-1 <sup>1</sup> | 4-1601140-1                                                                      |
|                                         | 1601433                         |                          |           |                    |                 |                                       |                                                                                  |
|                                         | 1601440                         |                          |           |                    |                 |                                       |                                                                                  |

1 Reversed Reeled—Consult TE drawing for orientation.  
 2 Loose Single.  
 3 Loose Bussed (Bridged) Double.  
 4 Loose Bussed (Bridged) Triple.  
 5 Finish is Post Plated Tin over Copper (Consult TE drawing for specifics).  
 6 Lead wire may be stranded, solid or bonded with 105°C PVC insulation. Contact TE Engineering when using other types of insulation.  
 7 Magnet wire 30 AWG [0.25 mm] and smaller also requires a wrap post per drawing 1601447.  
 8 Wire Specific terminals have a top contact designed to penetrate difficult Lead Wire Insulation (e.g Irradiated types).



**SIAMEZE Terminals** (Continued)

**Receptacle Terminals  
(Wire to Blade)**

**Material**

Brass

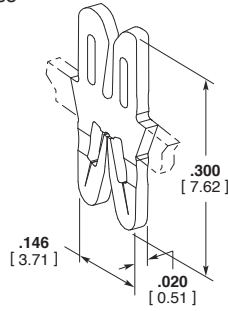

**A**



**B**



**C**



**D**

| Type                                  | Recommended Pocket <sup>5</sup> | Copper Magnet Wire Range |           | L <sup>8</sup> Dim. | Mating Tab Size | Part Number                |                          |
|---------------------------------------|---------------------------------|--------------------------|-----------|---------------------|-----------------|----------------------------|--------------------------|
|                                       |                                 | AWG                      | mm        |                     |                 | Reeled                     | Loose                    |
| A<br>Wire2Blade In Line               | 1601425                         | 18-34                    | 1.02-0.16 | .300<br>7.62        | .020<br>0.51    | 1601075-1                  | 4-1601075-1 <sup>2</sup> |
|                                       |                                 |                          |           |                     |                 | 2-1601075-1 <sup>1</sup>   |                          |
|                                       |                                 |                          |           |                     |                 | 1601075-2 <sup>6</sup>     | 4-1601075-2 <sup>6</sup> |
|                                       |                                 |                          |           |                     |                 | 2-1601075-2 <sup>1,6</sup> |                          |
|                                       |                                 |                          |           |                     |                 | 2-1601075-3 <sup>1,7</sup> | -                        |
| B<br>Wire2Blade High Carrier In Line  | 1601426                         | 18-34                    | 1.02-0.16 | .300<br>7.62        | .020<br>0.51    | 1601196-1                  | 4-1601196-1 <sup>2</sup> |
|                                       |                                 |                          |           |                     |                 | 2-1601196-1 <sup>1</sup>   | 6-1601196-1 <sup>3</sup> |
|                                       |                                 |                          |           |                     |                 |                            | 8-1601196-1 <sup>4</sup> |
| C<br>Wire2Blade In Line Medium Range  | 1601436                         | 15-23                    | 1.47-0.56 | .550<br>13.97       | .032<br>0.81    | 1601232-2 <sup>7</sup>     | 4-1601232-2 <sup>7</sup> |
|                                       |                                 |                          |           |                     |                 | 2-1601232-2 <sup>1,7</sup> |                          |
| D<br>Wire2Blade Off Line Medium Range | 1601437                         | 15-23                    | 1.47-0.56 | .310<br>7.87        | .032<br>0.81    | 1601137-2 <sup>6</sup>     | 4-1601137-2 <sup>6</sup> |
|                                       |                                 |                          |           |                     |                 | 2-1601137-2 <sup>1,6</sup> |                          |

1 Reverse Reeled –Consult TE drawing for orientation.  
 2 Loose Single.  
 3 Loose Bussed (Bridged) Double.  
 4 Loose Bussed (Bridged) Triple.  
 5 Magnet wire 30 AWG [0.25] and smaller also requires a wrap post per Specification 1601447.  
 6 Finish is Pre Plated Tin (Consult TE drawing for specifics).  
 7 Finish is Post Plated Tin over Nickel (Consult TE drawing for specifics).  
 8 Overall Height of terminal does not include inserted Blade (Tab).

**Pin Terminals**

**Material**

Brass



**E**

| Type           | Recommended Pocket <sup>2</sup> | Copper Magnet Wire Range |           | L Dim.        | Pin Dia.     | Part Number              |                          |
|----------------|---------------------------------|--------------------------|-----------|---------------|--------------|--------------------------|--------------------------|
|                |                                 | AWG                      | mm        |               |              | Reeled                   | Loose                    |
| E<br>Round Pin | 1601424                         | 18-34                    | 1.02-0.16 | .718<br>18.24 | .084<br>2.13 | 1601077-1                | 4-1601077-1 <sup>3</sup> |
|                |                                 |                          |           |               |              | 2-1601077-1 <sup>1</sup> |                          |

1 Reverse Reeled –Consult TE drawing for orientation.  
 2 Magnet wire 30 AWG [0.25 mm] and smaller also requires a wrap post per drawing 1601447.  
 3 Loose piece single.

SIAMEZE Terminals

**SIAMEZE Terminals (Continued)**

**Post Terminals**

**Material**

Brass

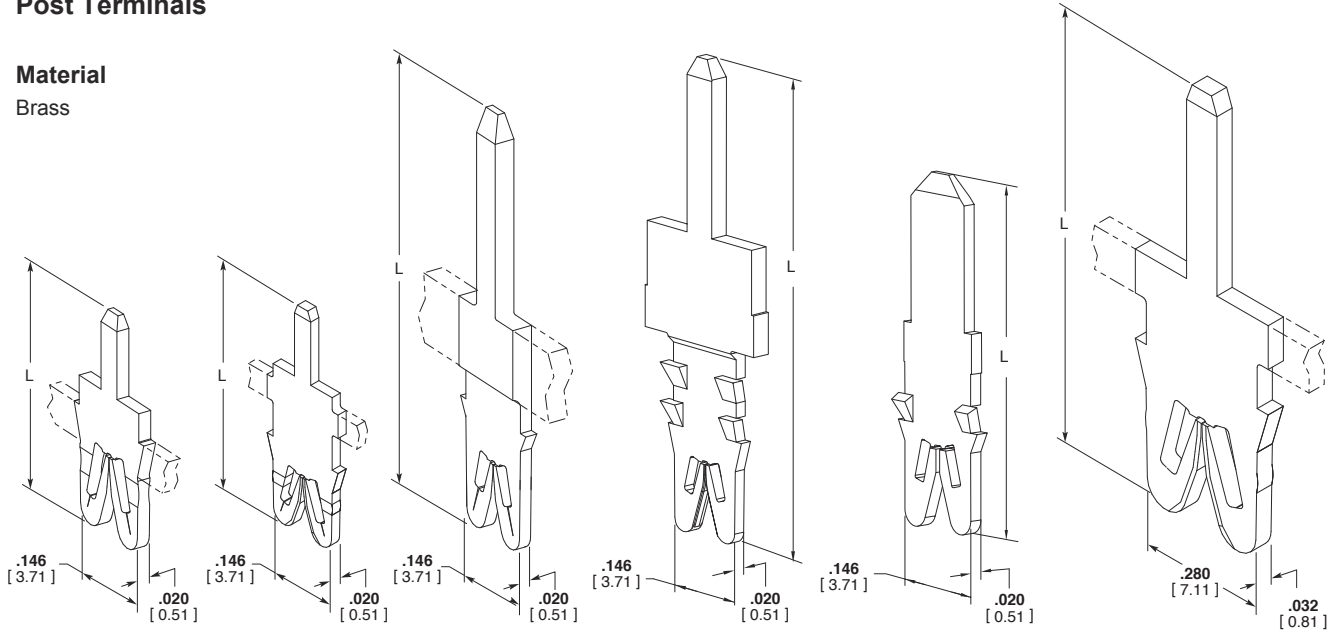

| Type                              | Recommended Pocket <sup>7</sup> | Copper Magnet Wire Range |           | Tab Size                   | L Dim.                     | Part Number                |                            |
|-----------------------------------|---------------------------------|--------------------------|-----------|----------------------------|----------------------------|----------------------------|----------------------------|
|                                   |                                 | AWG                      | mm        |                            |                            | Reeled                     | Loose                      |
| A<br>PC Tab                       | 1601424                         | 18-34                    | 1.02-0.16 | .040 x .020                | .345                       | 1601009-4 <sup>5</sup>     | 4-1601009-4 <sup>2.5</sup> |
|                                   |                                 |                          |           | 1.02 x 0.51                | 8.76                       | 2-1601009-4 <sup>1.5</sup> |                            |
|                                   |                                 | 29**                     | 0.29      | .040 x .020                | .405                       | 1601214-2 <sup>5</sup>     | 4-1601214-2 <sup>2.5</sup> |
|                                   |                                 |                          |           | 1.02 x 0.51                | 10.29                      | 2-1601214-2 <sup>1.5</sup> |                            |
| 27-36                             | 0.36-0.13                       | .040 x .020              | .345      | 1601155-3 <sup>5</sup>     | 4-1601155-3 <sup>2.5</sup> |                            |                            |
|                                   |                                 | 1.02 x 0.51              | 8.76      | 2-1601155-3 <sup>1.5</sup> |                            |                            |                            |
| B<br>Extended PC Tab              | 1601425                         | 18-34                    | 1.02-0.16 | .040 x .020                | .456                       | 1601095-2 <sup>4</sup>     | 4-1601095-2 <sup>2.4</sup> |
|                                   |                                 |                          |           | 1.02 x 0.51                | 11.57                      | 2-1601095-2 <sup>2.4</sup> |                            |
|                                   |                                 | 27-36                    | 0.36-0.13 | .040 x .020                | .485                       | 1601041-3 <sup>5</sup>     | 4-1601041-3 <sup>2.5</sup> |
|                                   |                                 |                          |           | 1.02 x 0.51                | 12.32                      | 2-1601041-3 <sup>1.5</sup> |                            |
| C<br>Long Narrow Blade            | 1601431                         | 18-34                    | 1.02-0.16 | .040 x .020                | .485                       | 1601128-3 <sup>5</sup>     | 4-1601128-3 <sup>2.5</sup> |
|                                   |                                 |                          |           | 1.02 x 0.51                | 12.32                      | 2-1601128-3 <sup>1.5</sup> |                            |
|                                   |                                 |                          |           | .047 x .032                | .754                       | 1601110-2 <sup>6</sup>     | 4-1601110-2 <sup>2.5</sup> |
|                                   |                                 |                          |           | 1.20 x 0.81                | 19.16                      | 2-1601110-2 <sup>1.6</sup> |                            |
|                                   |                                 |                          |           | .059 x .032                | .669                       | 1601099-2 <sup>5</sup>     | 4-1601099-2 <sup>2.5</sup> |
|                                   |                                 |                          |           | 1.50 x 0.81                | 17.00                      | 2-1601099-2 <sup>1.5</sup> |                            |
|                                   |                                 |                          |           | .059 x .032                | .756                       | 1601063-2 <sup>6</sup>     | 4-1601063-2 <sup>2.6</sup> |
|                                   |                                 |                          |           | 1.50 x 0.81                | 19.21                      | 2-1601063-2 <sup>1.6</sup> |                            |
| D<br>Long Narrow Blade Mult-Barb  | 1601425                         | 18-34                    | 1.02-0.16 | .059 x .032                | .904                       | 1601037-2 <sup>6</sup>     | 4-1601037-2 <sup>2.6</sup> |
|                                   |                                 |                          |           | 1.50 x 0.81                | 22.96                      | 2-1601037-2 <sup>1.6</sup> |                            |
|                                   |                                 |                          |           | .059 x .032                | 1.005                      | 1601066-2 <sup>6</sup>     | 4-1601066-2 <sup>2.6</sup> |
|                                   |                                 |                          |           | 1.50 x 0.81                | 25.53                      | 2-1601066-2 <sup>1.6</sup> |                            |
| E<br>Medium Width Blade Mult-Barb | 1601475                         | 18-34                    | 1.02-0.16 | .071 x .025                | .974                       | 1601104-2 <sup>6</sup>     | 4-1601104-2 <sup>2.6</sup> |
|                                   |                                 |                          |           | 1.80 x 0.64                | 24.74                      | 2-1601104-2 <sup>1.6</sup> |                            |
| F<br>Medium Width Blade           | 1601438                         | 12-23                    | 0.56-2.06 | .059 x .032                | .805                       | 293214-1                   | —                          |
|                                   |                                 |                          |           | 1.50 x 0.81                | 20.45                      | 2-293214-1 <sup>1</sup>    |                            |
| Medium wire range                 | 1601438                         | 12-23                    | 0.56-2.06 | .118 x .020                | .533                       | 1601243-2 <sup>3</sup>     | 4-1601243-2 <sup>2.3</sup> |
|                                   |                                 |                          |           | 3.00 x 0.51                | 13.54                      | 2-1601243-2 <sup>1.3</sup> |                            |
| Medium wire range                 | 1601438                         | 12-23                    | 0.56-2.06 | .118 x .025                | .952                       | 1601119-2 <sup>6</sup>     | 4-1601119-2 <sup>2.6</sup> |
|                                   |                                 |                          |           | 3.00 x 0.64                | 24.18                      | 2-1601119-2 <sup>1.6</sup> |                            |

1 Reverse Reeled –Consult TE drawing for orientation.  
 3 Finish is Post Plated Tin (Consult TE drawing for specifics).  
 5 Finish is Post Plated Tin over Nickel (Consult TE drawing for specifics).  
 7 Magnet wire 30 AWG [0.25] and smaller also requires a wrap post per Specification 1601447

2 Loose Piece Single.  
 4 Finish is Post Plated Tin over Copper (Consult TE drawing for specifics).  
 6 Finish is Pre Plated Tin (Consult TE drawing for specifics)  
 \*\* Compliant contact can connect 2 wires of the same diameter.

**SIAMEZE Terminals (Continued)**
**110 Series (2.8 mm wide)  
FASTON Tab Terminals**
**Material**

Brass



| Type                               | Recommended Pocket <sup>8</sup> | Copper Magnet Wire Range |           | Thickness | L Dim.                       | Part Number                  |                              |
|------------------------------------|---------------------------------|--------------------------|-----------|-----------|------------------------------|------------------------------|------------------------------|
|                                    |                                 | AWG                      | mm        |           |                              | Reeled                       | Loose                        |
| A<br>Single Barb                   | 1601425                         | 18-34                    | 1.02-0.16 | .020      | .640                         | 1601005-1                    | 4-1601005-1 <sup>2</sup>     |
|                                    |                                 |                          |           | 0.51      | 16.26                        | 2-1601005-1 <sup>1</sup>     |                              |
|                                    |                                 |                          |           | .020      | .640                         | 1601204-2 <sup>6,7</sup>     | 4-1601204-2 <sup>2,6,7</sup> |
|                                    |                                 |                          |           | 0.51      | 16.26                        | 2-1601204-2 <sup>1,6,7</sup> |                              |
|                                    |                                 |                          |           | .020      | .846                         | 1601045-1                    | 4-1601045-1 <sup>2</sup>     |
|                                    |                                 |                          |           | 0.51      | 21.49                        | 2-1601045-1 <sup>1</sup>     |                              |
| B<br>Single Barb<br>Low Transition | 1601431                         | 18-34                    | 1.02-0.16 | .020      | .846                         | 1601059-1 <sup>7</sup>       | 4-1601059-1 <sup>2,7</sup>   |
|                                    |                                 |                          |           | 0.51      | 21.49                        | 2-1601059-1 <sup>1,7</sup>   |                              |
|                                    |                                 |                          |           | .020      | .925                         | 1601073-1                    | 4-1601073-1 <sup>2</sup>     |
|                                    |                                 |                          |           | 0.51      | 23.50                        | 2-1601073-1 <sup>1</sup>     |                              |
|                                    |                                 |                          |           | .032      | .945                         | 1601097-3 <sup>6,7</sup>     | 4-1601097-3 <sup>2,6,7</sup> |
|                                    |                                 |                          |           | 0.81      | 24.00                        | 2-1601097-3 <sup>1,6,7</sup> |                              |
| C<br>Multi-Barb                    | 1601425                         | 18-34                    | 1.02-0.16 | .020      | .655                         | 1601039-1                    | 4-1601039-1 <sup>2</sup>     |
|                                    |                                 |                          |           | 0.51      | 16.63                        | 2-1601039-1 <sup>1</sup>     |                              |
|                                    |                                 |                          |           | .020      | .655                         | 1601039-2 <sup>6</sup>       | 4-1601039-2 <sup>2,6</sup>   |
|                                    |                                 |                          |           | 0.51      | 16.63                        | 2-1601039-2 <sup>1,6</sup>   |                              |
|                                    |                                 |                          |           | .032      | .630                         | 1601064-1 <sup>7</sup>       | 4-1601064-1 <sup>2,7</sup>   |
|                                    |                                 |                          |           | 0.81      | 15.99                        | 2-1601064-1 <sup>1,7</sup>   |                              |
|                                    |                                 |                          |           | .032      | 1.240                        | 1601112-2 <sup>6,7</sup>     | 4-1601112-2 <sup>2,6,7</sup> |
|                                    |                                 |                          |           | 0.81      | 31.50                        | 2-1601112-2 <sup>1,6,7</sup> |                              |
|                                    |                                 |                          |           | .032      | 1.240                        | 1601133-2 <sup>6,7</sup>     | 4-1601133-2 <sup>2,6,7</sup> |
|                                    |                                 |                          |           | 0.81      | 31.50                        | 2-1601133-2 <sup>1,6,7</sup> |                              |
|                                    | 27-36                           | 0.36-0.13                | .032      | 1.240     | 1601133-2 <sup>6,7</sup>     | 4-1601133-2 <sup>2,6,7</sup> |                              |
|                                    |                                 |                          | 0.81      | 31.50     | 2-1601133-2 <sup>1,6,7</sup> |                              |                              |

1 Reverse Reeled-Consult TE drawing for orientation.  
 2 Loose Piece Single.  
 3 Finish is Post Plated Tin over Nickel (Consult TE drawing for specifics).  
 4 Finish is Post Plated Tin (Consult TE drawing for specifics).  
 5 Finish is Pre-Plated Tin over Copper (Consult TE drawing for specifics).  
 6 Finish is Pre-Plated Tin (Consult TE drawing for specifics).  
 7 No hole in Tab.  
 8 Magnet wire 30 AWG [0.25] and smaller also requires a wrap post per Specification 1601447.

**SIAMEZE Terminals (Continued)**

**187 Series (4.75 mm wide)  
FASTON Tab Terminals**

**Material**

Brass  
(except High Temp listed below)



| Type                                 | Recommended Pocket <sup>3</sup> | Copper Magnet Wire Range |           | Thickness | L Dim. | Part Number                  |                              |
|--------------------------------------|---------------------------------|--------------------------|-----------|-----------|--------|------------------------------|------------------------------|
|                                      |                                 | AWG                      | mm        |           |        | Reeled                       | Loose                        |
| A<br>Single Barb                     | 1601425                         | 18-34                    | 1.02-0.16 | .020      | .605   | 1601006-2 <sup>5</sup>       | 4-1601006-2 <sup>2,5</sup>   |
|                                      |                                 |                          |           | 0.51      | 15.37  | 2-1601006-2 <sup>1,5</sup>   |                              |
| B<br>Single Barb<br>Short Pocket     | 1601427                         | 18-34                    | 1.02-0.16 | .020      | .505   | 1601011-1                    | 4-1601011-1 <sup>2</sup>     |
|                                      |                                 |                          |           | 0.51      | 12.83  | 2-1601011-1 <sup>1</sup>     |                              |
|                                      |                                 |                          |           | .020      | .590   | 1601018-2 <sup>5,6</sup>     | 4-1601018-2 <sup>2,5,6</sup> |
|                                      |                                 |                          |           | 0.51      | 14.99  | 2-1601018-2 <sup>1,5,6</sup> |                              |
|                                      |                                 |                          |           | .020      | .985   | 1601033-2 <sup>5,6</sup>     | 4-1601033-2 <sup>2,5,6</sup> |
|                                      |                                 |                          |           | 0.51      | 25.02  | 2-1601033-2 <sup>1,5,6</sup> |                              |
|                                      |                                 |                          |           | .020      | .618   | 1601021-2 <sup>5,6</sup>     | 4-1601021-2 <sup>2,5,6</sup> |
|                                      |                                 |                          |           | 0.51      | 15.70  | 2-1601021-2 <sup>1,5,6</sup> |                              |
|                                      |                                 |                          |           | .020      | .655   | 1601013-1                    | 4-1601013-1 <sup>2</sup>     |
|                                      |                                 |                          |           | 0.51      | 16.64  | 2-1601013-1 <sup>1</sup>     |                              |
| C<br>Multi-Barb                      | 1601425                         | 18-34                    | 1.02-0.16 | .020      | .791   | 3-1601072-2 <sup>5,6</sup>   | 4-1601072-2 <sup>2,5,6</sup> |
|                                      |                                 |                          |           | 0.51      | 20.09  |                              |                              |
|                                      |                                 |                          |           | .020      | 0.832  | 1601068-2 <sup>5,6</sup>     | 4-1601068-2 <sup>2,5,6</sup> |
|                                      |                                 |                          |           | 0.51      | 21.14  | 2-1601068-2 <sup>1,5,6</sup> |                              |
|                                      |                                 |                          |           | .032      | .625   | 1601174-2 <sup>5,6</sup>     | 4-1601174-2 <sup>2,5,6</sup> |
|                                      |                                 |                          |           | 0.81      | 15.88  | 2-1601174-2 <sup>1,5,6</sup> |                              |
|                                      |                                 |                          |           | .032      | .655   | 1601035-1                    | 4-1601035-1 <sup>2</sup>     |
|                                      |                                 |                          |           | 0.81      | 16.64  | 2-1601035-1 <sup>1</sup>     |                              |
|                                      |                                 |                          |           | .032      | .655   | 1601035-2 <sup>5</sup>       | 4-1601035-2 <sup>2,5</sup>   |
|                                      |                                 |                          |           | 0.81      | 16.64  | 2-1601035-2 <sup>1,5</sup>   |                              |
|                                      |                                 | 20-23**                  | 0.58-0.81 | .032      | .745   | 293029-1 <sup>5</sup>        | -                            |
|                                      |                                 |                          |           | 0.81      | 18.92  | 2-293029-1 <sup>1,5</sup>    |                              |
| D<br>Multi-Barb<br>Short Profile     | 1601434                         | 18-34                    | 1.02-0.16 | .020      | .655   | 1601142-1                    | 4-1601142-1 <sup>2</sup>     |
|                                      |                                 |                          |           | 0.51      | 16.64  | 2-1601142-1 <sup>1</sup>     |                              |
|                                      |                                 |                          |           | .032      | 0.492  | 1601058-2 <sup>5,7</sup>     | 4-1601058-2 <sup>2,5,7</sup> |
|                                      |                                 |                          |           | 0.81      | 12.50  | 2-1601058-2 <sup>1,5,7</sup> |                              |
|                                      |                                 |                          |           | .032      | 0.571  | 1601226-1 <sup>3,6</sup>     | 4-1601226-1 <sup>2,3,6</sup> |
|                                      |                                 |                          |           | 0.81      | 14.50  | 2-1601226-1 <sup>1,3,6</sup> |                              |
| E<br>Multi-Barb<br>.187/.250 Profile | 1601425                         | 18-34                    | 1.02-0.16 | .020      | .655   | 1601020-1                    | 4-1601020-1 <sup>2</sup>     |
|                                      |                                 |                          |           | 0.51      | 16.64  | 2-1601020-1 <sup>1</sup>     |                              |
|                                      |                                 |                          |           | .020      | .655   | 1601020-2 <sup>5</sup>       | 4-1601020-2 <sup>2,5</sup>   |
|                                      |                                 |                          |           | 0.51      | 16.64  | 2-1601020-2 <sup>1,5</sup>   |                              |
|                                      |                                 | 18-34                    | 1.02-0.16 | .020      | .805   | 1601049-2 <sup>5</sup>       | 4-1601049-2 <sup>2,5</sup>   |
|                                      |                                 |                          |           | 0.51      | 20.45  | 2-1601049-2 <sup>1,5</sup>   |                              |

1 Reverse Reeled-Consult TE drawing for orientation.  
 3 High Temperature Copper Alloy.  
 5 Finish is Pre Plated Tin (Consult TE drawing for specifics).  
 7 Extra Short Tab-Does not meet UL & NEMA length requirements.  
 \*\* Compliant contact can connect 2 wires of the same diameter

2 Loose Piece Single.  
 4 Finish is Post Plated Tin (Consult TE drawing for specifics).  
 6 No hole in Tab.  
 8 Magnet wire 30 AWG [0.25] and smaller also requires a wrap post per Specification 1601447.

**SIAMEZE Terminals (Continued)**
**250 Series (6.3 mm wide)  
FASTON Tab Terminals**
**Material**

Brass

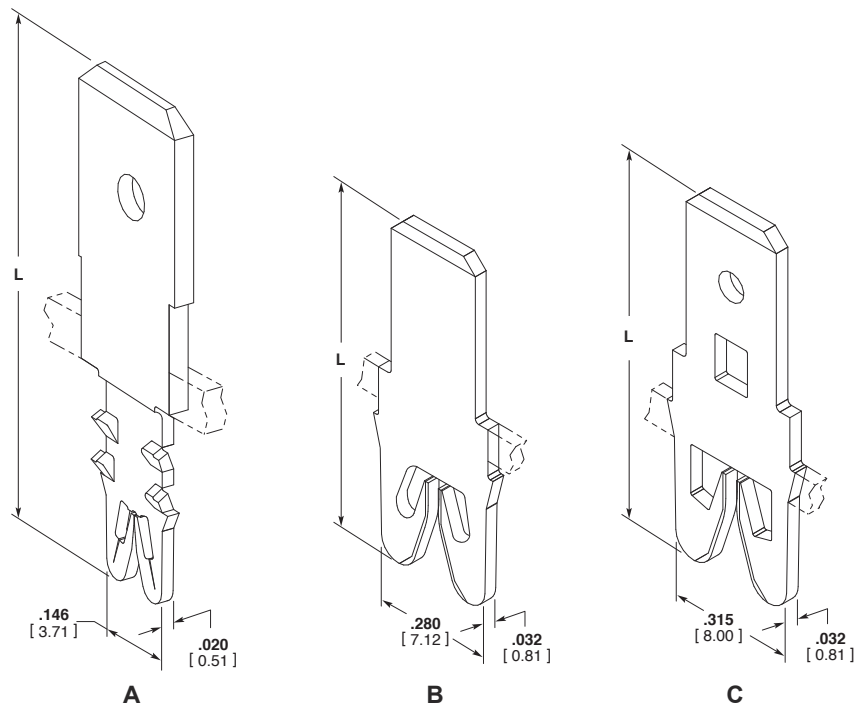

| Type                             | Recommended Pocket <sup>6</sup> | Copper Magnet Wire Range |           | L Dim.             | Tab Feature | Tab Size                   | Part Number                                        |                            |                        |                          |
|----------------------------------|---------------------------------|--------------------------|-----------|--------------------|-------------|----------------------------|----------------------------------------------------|----------------------------|------------------------|--------------------------|
|                                  |                                 | AWG                      | mm        |                    |             |                            | Reeled                                             | Loose                      |                        |                          |
| A<br>Multi-Barb                  | 1601425                         | 27-36                    | 0.36-0.13 | .745               | Hole        | .250 x .032<br>6.35 x 0.81 | 1601118-2 <sup>3</sup>                             | 4-1601118-2 <sup>3</sup>   |                        |                          |
|                                  |                                 |                          |           | 18.92              |             |                            | 2-1601118-2 <sup>1,3</sup>                         |                            |                        |                          |
|                                  |                                 | 18-34                    | 1.02-0.16 | .745               | Hole        | .250 x .032<br>6.35 x 0.81 | 1601002-2 <sup>3</sup>                             | 4-1601002-2 <sup>3</sup>   |                        |                          |
|                                  |                                 |                          |           | 18.92              |             |                            | 2-1601002-2 <sup>1,3</sup>                         |                            |                        |                          |
|                                  |                                 |                          |           |                    |             | .805<br>20.45              | Hole                                               | .250 x .032<br>6.35 x 0.81 | 1601028-2 <sup>3</sup> | 4-1601028-2 <sup>3</sup> |
|                                  |                                 |                          |           |                    |             |                            |                                                    |                            |                        |                          |
|                                  |                                 |                          |           |                    | Dimple      | .250 x .032<br>6.35 x 0.81 | 1601028-1<br>2-1601028-1 <sup>1</sup>              | 4-1601028-1                |                        |                          |
|                                  |                                 |                          |           | 1.281<br>32.53     | Hole        | .250 x .032<br>6.35 x 0.81 | 284937-1 <sup>7</sup><br>2-284937-1 <sup>1,7</sup> | —                          |                        |                          |
| B<br>Single Barb<br>Medium Range | 1601438                         | 12-23                    | 2.03-0.56 | .778               | —           | .250 x .032<br>6.35 x 0.81 | 1601061-2 <sup>3</sup>                             | 4-1601061-2 <sup>3</sup>   |                        |                          |
|                                  |                                 |                          |           | 19.76              |             |                            | 2-1601061-2 <sup>1,3</sup>                         |                            |                        |                          |
| C<br>Single Barb<br>Heavy Range  | 1601435                         | 12-20                    | 2.03-0.8  | .885               | Hole        | .250 x .032<br>6.35 x 0.81 | 1601115-1                                          | 4-1601115-1                |                        |                          |
|                                  |                                 |                          |           | 22.48              |             |                            | 2-1601115-1 <sup>1</sup>                           |                            |                        |                          |
|                                  |                                 |                          |           | 16-17 <sup>5</sup> |             |                            | 1.27-1.15                                          |                            | .885                   | Hole                     |
| 22.48                            | 2-1601159-1 <sup>1</sup>        |                          |           |                    |             |                            |                                                    |                            |                        |                          |
|                                  |                                 | 14-15 <sup>5</sup>       | 1.60-1.40 | .885               | Hole        | .250 x .032<br>6.35 x 0.81 | 1601161-1<br>2-1601161-1 <sup>1</sup>              | 4-1601161-1                |                        |                          |
|                                  |                                 |                          |           | 22.48              |             |                            |                                                    |                            |                        |                          |

1 Reverse Reeled –Consult TE drawing for orientation.

2 Finish is Pre-Plated Tin over Copper (Consult TE drawing for specifics).

3 Finish is Pre-Plated Tin (Consult TE drawing for specifics).

4 Double Carrier Strip.

5 Two magnet wires may be terminated in the same slot if diameters are equal.

6 Magnet wire 30 AWG [0.25 mm] and smaller also requires a wrap post per drawing 1601447.

7 Hole size and position complies with DIN standard.

**SIAMEZE Terminals** (Continued)

**Typical Plastic Cavity Pockets**

**Note:**The overall dimensions shown on these pages are for general reference only. For design purposes refer to the TE Cavity Specification.

Plastic cavities, designed to TE specifications, may be molded as part of the coil bobbin or attached to a lamination stack in the area of the magnet wire coil.

Each cavity is a rectangular box with two narrow slots on opposing walls and a plastic cutoff or tie-off post.

During or after the winding process, the magnet wire is placed across the plastic cavities and into the slots, either manually or by coil winding equipment.

Unraveling is prevented by a slight friction fit, suitable bend or by wrapping the magnet wire around the wrap post.

During insertion, the insulation displacing terminal slot strip the film insulation from the magnet wire producing a stable electrical termination.

Terminal retention is retained in the plastic cavities by single or multiple barbs (Refer to Product Spec for force requirements).

Excess magnet wire is trimmed flush with the outside of the plastic cavity by a shear blade traveling with the terminal insertion ram.

**TE can provide design and mold engineering resources to manufacture most specifically designed SIAMEZE cavity housings.**

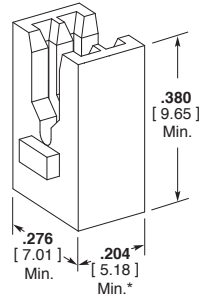

Cavity Specification 1601421

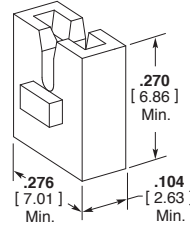

Cavity Specification 1601424

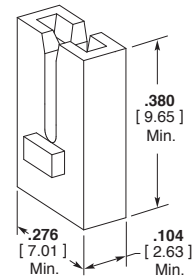

Cavity Specification 1601425

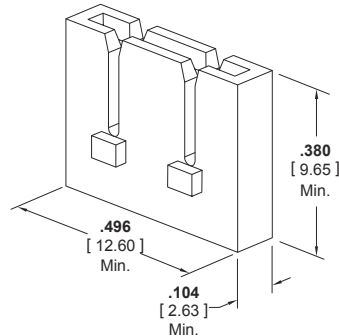

Cavity Specification 1601426

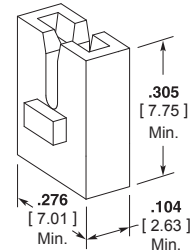

Cavity Specification 1601427



Cavity Specification 1601431

\* Minimum dimension with Lead Lok slot.

**SIAMEZE Terminals (Continued)**

**Typical Plastic Cavity Pockets (Continued)**



**Cavity Specification 1601432**



**Cavity Specification 1601433**



**Cavity Specification 1601434**

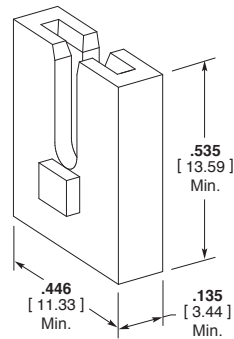

**Cavity Specification 1601435**



**Cavity Specification 1601436**



**Cavity Specification 1601437**



**Cavity Specification 1601438**

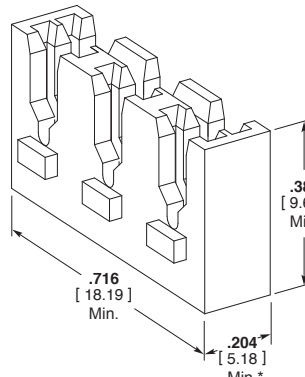

**Cavity Specification 1601440**



**Wrap Post Specification 1601447**



**Cavity Specification 1601475**

\* Minimum dimension with Lead Lok slot.



## AMPLIVAR Splices

### Product Facts

- **Compression crimp eliminates cold solder points, weld burns and wire embrittlement usually connected with thermal-type terminations**
- **Excellent tensile strength—vibration resistant**
- **Provides a superior electrical connection that is free of many contaminants such as stripper residue and solder flux**
- **Precision formed, strip-fed splices terminated in automatic machines for high production rates per hour**
- **High termination rates, low wire consumption and the elimination of rejects caused by solder flux or heat damage results in the lowest applied costs**
- **Precisely controlled crimp termination helps eliminate human error for maximum reliability**
- **Splice up to 3 magnet wires together with stranded lead in one barrel**

### Applications

- **Motor windings and connections**
- **Coil connections**
- **Transformer windings and connections**
- **Solid wire connections**
- **Lighting ballasts**
- **Power supplies**
- **Starters and alternators**



TE Connectivity offers a full selection of AMPLIVAR splices that are specifically designed to terminate magnet wire to itself or in combination with standard solid or stranded lead wire.

AMPLIVAR splices have machined, sharp edged serrations inside the crimp barrels. These serrations, made by a special production process, pierce the insulating layer of magnet wires in a manner that provides a large contact area.

In a one-step operation the magnet wire is automatically multiple ring-stripped of its

insulation as it is forced into the serrations during the precisely controlled crimp.

The resulting termination produces a high tensile strength, air-sealed connection that is as resistant to corrosion as the insulated conductor.

As many as three magnet wires can be terminated simultaneously in one splice. In addition, copper or aluminum magnet wire, or a combination of both, can be terminated.

When required, copper or aluminum magnet wire can

be combined with standard, pre-stripped solid or stranded lead wires.

Depending on your specific application, AMPLIVAR splices are available in 5, 7 and 9 serration versions for terminations in the 100 to 22,000 CMA range as well as miniature and subminiature designs for terminations in the 100 to 1850 CMA range.

The crimping of AMPLIVAR splices is done by semi-automatic crimping machines for high output per hour production rates.



Stranded Wire on top

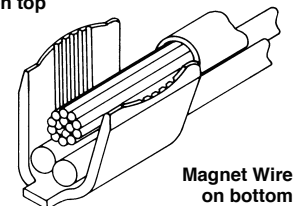

Magnet Wire on bottom

**AMPLIVAR Splices** (Continued)

**Technical Features**

**Applicable Types of Wire** — Cu, Al (Solid) together or in combination with stranded lead wire

**Wire Size Range** — from 300 to 13,000 CMA (0.1 mm<sup>2</sup> to 6.6 mm<sup>2</sup>)

**Terminal Base Material** — Brass, phosphor bronze

**Surface Finish** — plain and tin plated except where noted

**Temperature Range** — -65°C to +150°C

**Rated Current** — according connected wire size

**Rated Voltage** — according terminated winding

**Test Results**

The AMPLIVAR products have been subjected to the following tests without significant millivolt losses.

**Temperature Cycling** — 25 cycles with each cycle consisting of 30 minutes at +125°C followed by 30 minutes at -65°C

**Heat Age** — 96 hours at +150°C

**Thermal Shock** — 25 cycles with each cycle consisting of 30 minutes at +150°C followed by 30 minutes at -65°C

**Salt Spray** — 96 hours at +35°C with a 5% salt solution spray

**Humidity** — 96 hours at 90–95% relative humidity and +40°C

**Current Cycling** — 10,000 cycles with each consisting of 3 minutes on and 3 minutes off at a current (25 A) which establishes a wire temperature

**TYPICAL CURRENT CYCLING TEST RESULTS**

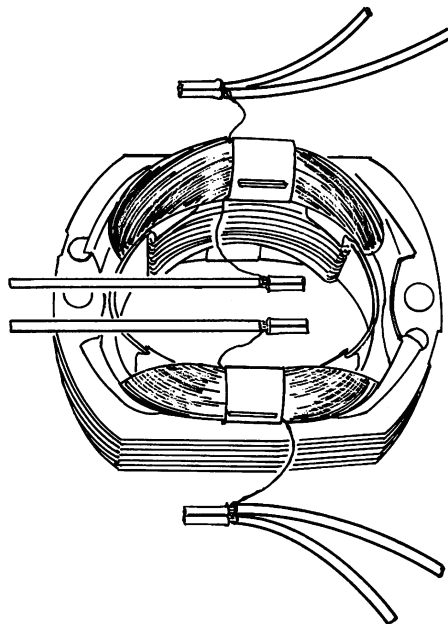
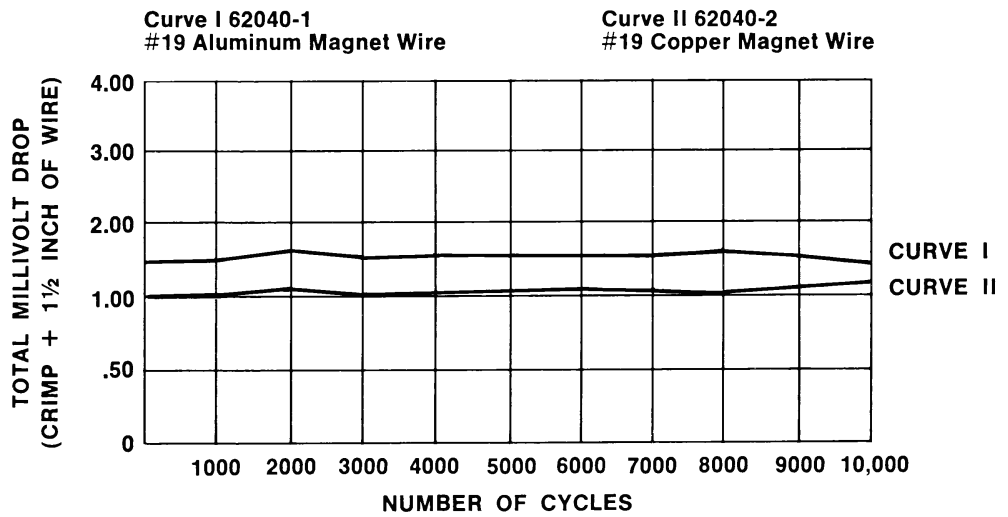

AMPLIVAR Splices

**AMPLIVAR Splices** (Continued)

**General Application Guidelines**

To assist you in obtaining the optimum AMPLIVAR product termination, the following guidelines are recommended:

1. All magnet wires must be placed in the bottom of the wire barrel before crimping. If lead wire is to be crimped in the same termination, it should be placed on top of the magnet wires.
2. Wire barrels are designed to accept a maximum of three insulated magnet wires plus stranded lead wires.
3. The ratio of magnet wire diameters crimped in any wire barrel should not exceed 2:1. This ratio is approximately a range from the largest to the smallest magnet wire of six sizes.
4. The sum of the circular mil area (CMA) of the magnet wires and any lead wires should not exceed the capacity of the splice.
5. The sum of the diameters of the individual magnet wires plus twice the terminal stock thickness must be equal to or less than the crimp width.
6. Magnet wire of 26 AWG [0.40 mm] or smaller should be used with 7-serration splices having "shallow serrations," and magnet wire of 28 AWG [0.32 mm] or smaller should be used with 9-serration splices having "shallow serrations" (part numbers identified with asterisk [\*] are in the tabular data on the following technical pages).
7. Magnet wire of 20 AWG [0.81 mm] or larger having an insulation thickness heavier than "single film coated," should not be used with splices having "shallow serrations" (those part numbers marked with an asterisk [\*] in the tabular data on the following technical pages).
8. When aluminum magnet wire is used, splices and terminals must be tin plated.
9. Consult TE for splice and terminal selection and recommendations for all non-standard applications.

**Technical Documents**

**Application specifications** describe requirements for using the product in its intended application and or crimping information. They are intended for the packaging and design engineer and the machine setup person.

|          |                                      |          |                                       |
|----------|--------------------------------------|----------|---------------------------------------|
| 114-2002 | AMPLIVAR 7-serration pigtail splices | 114-2006 | AMPLIVAR subminiature pigtail splices |
| 114-2003 | AMPLIVAR 9-serration pigtail splices | 114-2009 | AMPLIVAR 5-serration thru splices     |
| 114-2005 | AMPLIVAR subminiature thru splices   | 114-2016 | AMPLIVAR miniature pigtail splices    |

**Suggested Splice Selection Procedure**

Use the following guide to help you to determine the proper splice for your application:

1. Use 9-serration splices, tin plated when terminating aluminum magnet wire or combinations with aluminum magnet wire.
2. Use 9-serration splices for hermetic and severe environment applications.
3. Use splices identified with an asterisk [\*] when terminating 7-serration 26 AWG [0.40 mm] or smaller wires and 9-serration 28 AWG [0.32 mm] or smaller wires.
4. Calculate the total CMA of the magnet wires plus any lead wires to be terminated. Always use the coated magnet wire for CMA (see pages 90-91).
5. Calculate the total magnet wire diameters (see pages 90 and 91).
6. Select a splice for trial calculations. It should have the proper CMA range. Plating finish should be considered at this time.
7. Calculate the sum of the magnet wire diameters plus two splice stock thicknesses. If this total is less than the crimp width of the splice selected, it may be used. If the total is greater than the crimp width, a splice with a greater crimp width must be selected. Consult TE for special wide tooling recommendations.

**Example:**

- Selection of a pigtail splice to terminate the following wires:  
 One 28 AWG [0.32 mm] copper magnet wire.  
 One 22 AWG [0.64 mm] aluminum magnet wire.  
 One 18 AWG [0.8-0.9 mm<sup>2</sup>] 19-strand copper lead wire.

■ Calculate the total CMA (Procedure 4):

|                                                      |   |                   |
|------------------------------------------------------|---|-------------------|
| 28 AWG [0.32 mm] coated magnet wire                  | = | 185 CMA           |
| 22 AWG [0.64 mm] coated magnet wire                  | = | 708 CMA           |
| 18 AWG [0.8-0.9 mm <sup>2</sup> ] stranded lead wire | = | 1608 CMA          |
| <b>Total</b>                                         |   | <b>= 2501 CMA</b> |

■ Calculate the sum of the magnet wire diameters (Procedure 5):

|                                     |   |                       |
|-------------------------------------|---|-----------------------|
| 28 AWG [0.32 mm] coated magnet wire | = | .0136 [0.35]          |
| 22 AWG [0.64 mm] coated magnet wire | = | .0266 [0.68]          |
| <b>Total</b>                        |   | <b>= .0402 [1.03]</b> |

■ Select a terminal for trial calculations. Splice No. 62305-2, page 47 (Procedure 6):

|                 |   |             |
|-----------------|---|-------------|
| CMA range       | = | 600-3000    |
| Stock thickness | = | .016 [0.41] |
| Crimp width     | = | .110 [2.79] |

9-serration, tin plated for aluminum magnet wire (Procedure 1).  
 Splice identified with asterisk [\*] for 28 AWG [0.32 mm] (Procedure 3).

■ Calculate the sum of the magnet wire diameters plus two splice stock thicknesses (Procedure 7):

.0402 + (.016 x 2) = .0722  
 [1.02 + (0.41 x 2) = 1.84  
 .0722 [1.84] is less than the splice crimp width of .110 [2.79]; therefore, Part No. 62305-2 may be used.

**AMPLIVAR Splices** (Continued)

**9 Serrations — Pigtail Type**

**Product Facts**

(Plus All 7 Serration Facts)

- Splice length is increased on larger CMA splices for improved performance
- Serration depths are varied within the splice to give optimum electrical/mechanical performance on all wire sizes
- Serration sidewall angles are varied to allow better wire stripping and serration fill
- Flat bottom of splice helps keep magnet wires on bottom as required during crimping
- Magnet wires 28 AWG [0.32 mm] and larger may be terminated without requiring shallow serrations
- Additional serrations enhance stability of crimp



| AWG/<br>mm <sup>2</sup> | Wire Range<br>Solid Dia. | Wire Range<br>CMA | Stock<br>Thickness | Crimp<br>Width | Dim.<br>L    | Material         | Part<br>Number |
|-------------------------|--------------------------|-------------------|--------------------|----------------|--------------|------------------|----------------|
| 24-18.5<br>0.26-0.80    | .020-.039<br>0.55-1.00   | 400-1500          | .016<br>0.41       | .080<br>2.03   | .225<br>5.72 | Tin Plated Brass | 62303-2*       |
| 22-15.5<br>0.38-1.54    | .028-.055<br>0.70-1.40   | 600-3000          | .020<br>0.51       | .110<br>2.79   | .225<br>5.72 | Tin Plated Brass | 62304-2        |
| 22-15.5<br>0.38-1.54    | .028-.055<br>0.70-1.40   | 600-3000          | .016<br>0.41       | .110<br>2.79   | .225<br>5.72 | Tin Plated Brass | 62305-2*       |
| 18.5-13.5<br>0.80-2.54  | .039-.071<br>1.00-1.80   | 1500-5000         | .020<br>0.51       | .110<br>2.79   | .225<br>5.72 | Tin Plated Brass | 62306-2        |
| 18.5-13.5<br>0.80-2.54  | .039-.071<br>1.00-1.80   | 1500-5000         | .016<br>0.41       | .110<br>2.79   | .225<br>5.72 | Tin Plated Brass | 62307-2*       |
| 15.5-12<br>1.54-3.46    | .055-.083<br>1.40-2.10   | 3000-7000         | .020<br>0.51       | .140<br>3.56   | .265<br>6.73 | Tin Plated Brass | 62308-2        |
| 13.5-10<br>2.54-4.90    | .071-.098<br>1.80-2.50   | 5000-10,000       | .025<br>0.64       | .180<br>4.57   | .265<br>6.73 | Tin Plated Brass | 62309-2        |
| 12-9<br>3.46-6.38       | .083-.112<br>2.10-2.85   | 7000-14,000       | .025<br>0.64       | .180<br>4.57   | .265<br>6.73 | Tin Plated Brass | 62310-2        |
| 10-8<br>4.90-8.60       | .098-.130<br>2.50-3.31   | 10,000-17,000     | .030<br>0.76       | .250<br>6.35   | .340<br>8.64 | Tin Plated Brass | 62311-2        |
| 9-6.5<br>7.07-9.45      | .118-.137<br>3.00-3.47   | 14,000-22,000     | .030<br>0.76       | .250<br>6.35   | .340<br>8.64 | Tin Plated Brass | 1742898-1      |

\*These splices are recommended for applications using wire size 28 AWG [0.32 mm] or smaller.  
 † Special high force application equipment required.



**7 Serrations — Pigtail Type**

**Product Facts**

- Taper on both crimper and anvil improves flex life of termination
- Longer “flat” on tooling improves electrical performance (.125 vs. .080 [3.18 vs. 2.03])
- Radius on wire entry end of splice helps prevent nicking wires and improves mechanical performance
- Serrations are offset to sheared end to place additional serrations in “electrical” portion of crimped splice
- Splice CMA ranges are overlapped so that two splices are available for any given CMA

| AWG/<br>mm <sup>2</sup> | Wire Range<br>Solid Dia. | Wire Range<br>CMA | Stock<br>Thickness | Crimp<br>Width | Dim.<br>L    | Material         | Part<br>Number       |
|-------------------------|--------------------------|-------------------|--------------------|----------------|--------------|------------------|----------------------|
| 22-15.5<br>0.38-1.54    | .028-.055<br>0.70-1.40   | 600-3000          | .020<br>0.51       | .110<br>2.79   | .225<br>5.72 | Brass            | 62000-1              |
| 22-15.5<br>0.38-1.54    | .028-.055<br>0.70-1.40   | 600-3000          | .020<br>0.51       | .110<br>2.79   | .225<br>5.72 | Brass            | 62157-1*             |
| 22-15.5<br>0.38-1.54    | .028-.055<br>0.70-1.40   | 600-3000          | .020<br>0.51       | .110<br>2.79   | .225<br>5.72 | Tin Plated Brass | 62000-2              |
| 22-15.5<br>0.38-1.54    | .028-.055<br>0.70-1.40   | 600-3000          | .020<br>0.51       | .110<br>2.79   | .225<br>5.72 | Tin Plated Brass | 62157-2*             |
| 22-15.5<br>0.38-1.54    | .028-.055<br>0.70-1.40   | 600-3000          | .020<br>0.51       | .110<br>2.79   | .225<br>5.72 | Tin Plated Brass | 62200-2 <sup>1</sup> |
| 18.5-13.5<br>0.80-2.54  | .039-.071<br>1.00-1.80   | 1500-5000         | .020<br>0.51       | .110<br>2.79   | .225<br>5.72 | Brass            | 62040-2              |
| 18.5-13.5<br>0.80-2.54  | .039-.071<br>1.00-1.80   | 1500-5000         | .020<br>0.51       | .110<br>2.79   | .225<br>5.72 | Tin Plated Brass | 62040-1              |
| 18.5-13.5<br>0.80-2.54  | .039-.071<br>1.00-1.80   | 1500-5000         | .020<br>0.51       | .110<br>2.79   | .225<br>5.72 | Phosphor Bronze  | 964156-1             |
| 15.5-12<br>1.54-3.46    | .055-.083<br>1.40-2.10   | 3000-7000         | .020<br>0.51       | .140<br>3.56   | .225<br>5.72 | Brass            | 62001-1              |
| 15.5-12<br>1.54-3.46    | .055-.083<br>1.40-2.10   | 3000-7000         | .020<br>0.51       | .140<br>3.56   | .225<br>5.72 | Tin Plated Brass | 62001-2              |
| 15.5-12<br>1.54-3.46    | .055-.083<br>1.40-2.10   | 3000-7000         | .020<br>0.51       | .140<br>3.56   | .225<br>5.72 | Tin Plated Brass | 62201-2 <sup>1</sup> |
| 12-10<br>2.10-6.0       | .085-.110<br>2.10-2.85   | 7000-12,000       | .025<br>0.64       | .250<br>6.35   | .225<br>5.72 | Tin Plated Brass | 62295-1              |
| 12-10<br>2.10-6.0       | .085-.110<br>2.10-2.85   | 7000-12,000       | .025<br>0.64       | .250<br>6.35   | .225<br>5.72 | Brass            | 62295-2              |
| 12-9<br>2.10-6.38       | .085-.115<br>2.10-3.47   | 7000-13,000       | .025<br>0.64       | .180<br>4.57   | .225<br>5.72 | Tin Plated Brass | 62002-2              |

\*These splices are recommended for applications using wire size 26 AWG [0.40 mm] or smaller.  
 † Flat bottom.



**AMPLIVAR Splices** (Continued)

**7 Serrations — Thru Type**

**Product Facts**

- Crimp bellmouth provides retention in circular cavity slot in bobbin



| AWG/<br>mm <sup>2</sup> | Wire Range<br>Solid Dia. | Wire Range<br>CMA | Stock<br>Thickness | Crimp<br>Width | Dim.<br>L    | Material         | Part<br>Number |
|-------------------------|--------------------------|-------------------|--------------------|----------------|--------------|------------------|----------------|
| 22-15.5<br>0.38-1.54    | .028-.055<br>0.70-1.40   | 600-3000          | .020<br>0.51       | .110<br>2.79   | .225<br>5.72 | Tin Plated Brass | 1217384-1*     |

\*These splices are recommended for applications using wire size 26 AWG [0.40 mm] or smaller.

**5 Serrations — Thru Type**

**Product Facts**

- Wide range of thru splice s
- Serrations centered in splice to achieve optimum electrical and mechanical performance in a thru splice
- CMA range accepts a wide variety of wire sizes and combinations

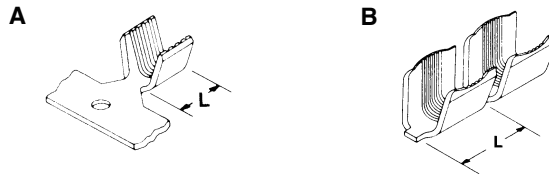

| Type              | AWG/<br>mm <sup>2</sup> | Wire Range<br>Solid Dia. | Wire Range<br>CMA | Stock<br>Thickness | Crimp<br>Width | Dim.<br>L        | Material             | Part<br>Number         |
|-------------------|-------------------------|--------------------------|-------------------|--------------------|----------------|------------------|----------------------|------------------------|
| A                 | 17-12.5<br>1.00-2.80    | .045-.075<br>1.15-1.85   | 2000-5400         | .020<br>0.51       | .110<br>5.08   | .235<br>5.97     | Brass                | 63564-1                |
|                   | 10-8<br>5.00-8.00       | .100-.125<br>2.55-3.20   | 10,000-16,000     | .032<br>0.80       | .180<br>4.57   | .267<br>6.78     | Tin Plated Brass     | 63561-1                |
|                   | 10-7.5<br>5.00-11.50    | .100-.150<br>2.60-3.80   | 10,400-22,900     | .030<br>0.76       | .300<br>7.62   | .310<br>7.87     | Tin Plated Brass     | 63562-1                |
| B                 | 22-15.5<br>0.38-1.54    | .028-.055<br>0.70-1.40   | 600-3000          | .020<br>0.51       | .110<br>2.79   | .225<br>5.72     | Brass                | 42076                  |
|                   | 22-15.5<br>0.38-1.54    | .028-.055<br>0.70-1.40   | 600-3000          | .020<br>0.51       | .110<br>2.79   | .225<br>5.72     | Brass                | 42192-1*               |
|                   | 22-15.5<br>0.38-1.54    | .028-.055<br>0.70-1.40   | 600-3000          | .020<br>0.51       | .110<br>2.79   | .225<br>5.72     | Tin Plated Brass     | 42192-2*               |
|                   | 22-15.5<br>0.38-1.54    | .028-.055<br>0.70-1.40   | 600-3000          | .020<br>0.51       | .110<br>2.79   | .225<br>5.72     | Brass                | 42778-1* <sup>1</sup>  |
|                   | 22-15.5<br>0.38-1.54    | .028-.055<br>0.70-1.40   | 600-3000          | .020<br>0.51       | .110<br>2.79   | .225<br>5.72     | Tin Plated Brass     | 42778-2* <sup>1</sup>  |
|                   | 18.5-13.5<br>0.80-2.54  | .039-.071<br>1.00-1.80   | 1500-5000         | .020<br>0.51       | .110<br>2.79   | .225<br>5.72     | Brass                | 41765                  |
|                   | 18.5-13.5<br>0.80-2.54  | .039-.071<br>1.00-1.80   | 1500-5000         | .020<br>0.51       | .110<br>2.79   | .225<br>5.72     | Tin Plated Brass     | 41899                  |
|                   | 18.5-13.5<br>0.80-2.54  | .039-.071<br>1.00-1.80   | 1500-5000         | .020<br>0.51       | .110<br>2.79   | .225<br>5.72     | Brass                | 42119-1*               |
|                   | 18.5-13.5<br>0.80-2.54  | .039-.071<br>1.00-1.80   | 1500-5000         | .020<br>0.51       | .110<br>2.79   | .225<br>5.72     | Brass                | 42776-1* <sup>1</sup>  |
|                   | 18.5-13.5<br>0.80-2.54  | .039-.071<br>1.00-1.80   | 1500-5000         | .020<br>0.51       | .110<br>2.79   | .225<br>5.72     | Tin Plated Brass     | 42776-2* <sup>1</sup>  |
|                   | 15.5-12<br>1.54-3.46    | .055-.083<br>1.40-2.10   | 3000-7000         | .020<br>0.51       | .140<br>3.56   | .225<br>5.72     | Brass                | 41766                  |
|                   | 15.5-12<br>1.54-3.46    | .055-.083<br>1.40-2.10   | 3000-7000         | .020<br>0.51       | .140<br>3.56   | .225<br>5.72     | Tin Plated Brass     | 41900                  |
|                   | 15.5-12<br>1.54-3.46    | .055-.083<br>1.40-2.10   | 3000-7000         | .020<br>0.51       | .140<br>3.56   | .225<br>5.72     | Brass                | 42779-1 <sup>1</sup>   |
|                   | 15.5-12<br>1.54-3.46    | .055-.083<br>1.40-2.10   | 3000-7000         | .020<br>0.51       | .140<br>3.56   | .225<br>5.72     | Tin Plated Brass     | 42779-2 <sup>1</sup>   |
|                   | 12-10<br>3.46-6.00      | .083-.110<br>2.10-2.80   | 7000-12,000       | .025<br>0.64       | .250<br>6.35   | .225<br>5.72     | Tin Plated Brass     | 61074-11. <sup>2</sup> |
|                   | 12-9<br>3.46-6.38       | .083-.112<br>2.10-2.85   | 7000-13,000       | .025<br>0.64       | .180<br>4.57   | .225<br>5.72     | Brass                | 41770                  |
|                   | 12-9<br>3.46-6.38       | .083-.112<br>2.10-2.85   | 7000-13,000       | .025<br>0.64       | .180<br>4.57   | .225<br>5.72     | Tin Plated Brass     | 41904                  |
|                   | 12-9<br>3.46-6.38       | .083-.112<br>2.10-2.85   | 7000-13,000       | .025<br>0.64       | .180<br>4.57   | .225<br>5.72     | Brass                | 42780-1 <sup>1</sup>   |
| 12-9<br>3.46-6.38 | .083-.112<br>2.10-2.85  | 7000-13,000              | .025<br>0.64      | .180<br>4.57       | .225<br>5.72   | Tin Plated Brass | 42780-2 <sup>1</sup> |                        |

\* These splices are recommended for applications using wire size 26 AWG [0.40 mm] or smaller.

<sup>1</sup> Increased terminal pitch.

<sup>2</sup> Increased U-diameter.

**AMPLIVAR Splices** (Continued)

**5 Serrations —  
Pigtail Type**
**Product Facts**

- Serration depths are varied within the splice to give optimum electrical / mechanical performance on all wire sizes
- Flat bottom of splice helps keep magnet wires on bottom as required during crimping



| AWG/<br>mm <sup>2</sup> | Wire Range<br>Solid Dia. | Wire Range<br>CMA | Stock<br>Thickness | Crimp<br>Width | Dim.<br>L | Material         | Part<br>Number        |
|-------------------------|--------------------------|-------------------|--------------------|----------------|-----------|------------------|-----------------------|
| 20-17                   | .030-.045                | 1000-2000         | .016               | .100           | .225      | Tin Plated Brass | 62670-2* <sup>1</sup> |
| 0.50-1.00               | 0.80-1.15                |                   | 0.41               | 2.54           | 5.72      |                  |                       |

\*These splices are recommended for applications using wire size 26 AWG [0.40 mm] or smaller.

<sup>1</sup> Flat bottom.

**Miniature Splice —  
Pigtail Type**
**Product Facts**

- The miniature AMPLIVAR splice was developed for crimping thinner copper magnet wires having a diameter between .003 and .016 [0.08 and 0.40 mm] and has to be connected with a stranded conductor
- The diameter of one conductor strand should not exceed the magnet wire diameter to be applied

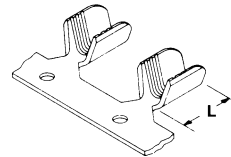

| AWG/<br>mm <sup>2</sup> | Wire Range<br>Solid Dia. | Wire Range<br>CMA | Stock<br>Thickness | Crimp<br>Width | Dim.<br>L | Material         | Part<br>Number |
|-------------------------|--------------------------|-------------------|--------------------|----------------|-----------|------------------|----------------|
| 27-21                   | .014-.030                | 200-850           | .012               | .055           | .195      | Tin Plated Brass | 63431-1        |
| 0.10-0.40               | 0.35-0.75                |                   | 0.30               | 1.40           | 4.95      |                  |                |
| 25-18                   | .015-.045                | 300-1850          | .012               | .070           | .195      | Copper-Nickel    | 61166-1        |
| 0.16-0.90               | 0.45-1.10                |                   | 0.30               | 1.78           | 4.95      |                  |                |
| 24-18.5                 | .020-.039                | 480-1500          | .014               | .080           | .195      | Tin Plated Brass | 62341-1        |
| 0.20-0.75               | 0.55-1.00                |                   | 0.36               | 2.03           | 4.95      |                  |                |
| 24-18.5                 | .020-.039                | 480-1500          | .014               | .080           | .195      | Brass            | 62341-2        |
| 0.20-0.75               | 0.55-1.00                |                   | 0.36               | 2.03           | 4.95      |                  |                |
| 24-18                   | .020-.040                | 480-1700          | .016               | .070           | .195      | Brass            | 62044-1        |
| 0.20-0.80               | 0.55-1.00                |                   | 0.41               | 1.78           | 4.95      |                  |                |

**Subminiature Splice —  
Thru or Pigtail Type**
**Product Facts**

- The compactness of these splices makes them ideal for use in small subfractional motors, transformers, relays, solenoids, indicator lamps and small appliance terminations
- These splices provide the same reliability as the larger AMPLIVAR splices

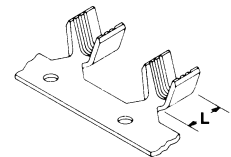

| AWG/<br>mm <sup>2</sup> | Wire Range<br>Solid Dia. | Wire Range<br>CMA | Stock<br>Thickness | Crimp<br>Width | Dim.<br>L | Material          | Part<br>Number |
|-------------------------|--------------------------|-------------------|--------------------|----------------|-----------|-------------------|----------------|
| 30-26                   | .010-.015                | 100-300           | .010               | .042           | .080      | Tin Plated Brass  | 63621-2        |
| 0.05-0.15               | 0.30-0.50                |                   | 0.25               | 1.08           | 2.03      |                   |                |
| 24-19                   | .020-.035                | 400-1300          | .016               | .070           | .100      | Tin Plated Brass  | 62194-2        |
| 0.26-0.60               | 0.55-0.90                |                   | 0.41               | 1.78           | 2.54      |                   |                |
| 24-19                   | .020-.035                | 400-1300          | .016               | .070           | .100      | Gold Plated Brass | 62194-4        |
| 0.26-0.60               | 0.55-0.90                |                   | 0.41               | 1.78           | 2.54      |                   |                |

## AMPLIVAR Terminals

### Products Facts

- Ring tongue terminals available for 2 to 3/8 stud diameters
- FASTON tab terminals accept .125 [3.18], .187 [4.75] and .250 [6.35] receptacle terminals
- FASTON receptacle terminals accept .187 [4.75] and .250 [6.35] tab terminals
- FASTON stator receptacle accept .250 x .032 [6.35 x 0.81] tab terminal
- Pin receptacle terminals accept .062 [1.57] and .090 [2.29] diameter pins

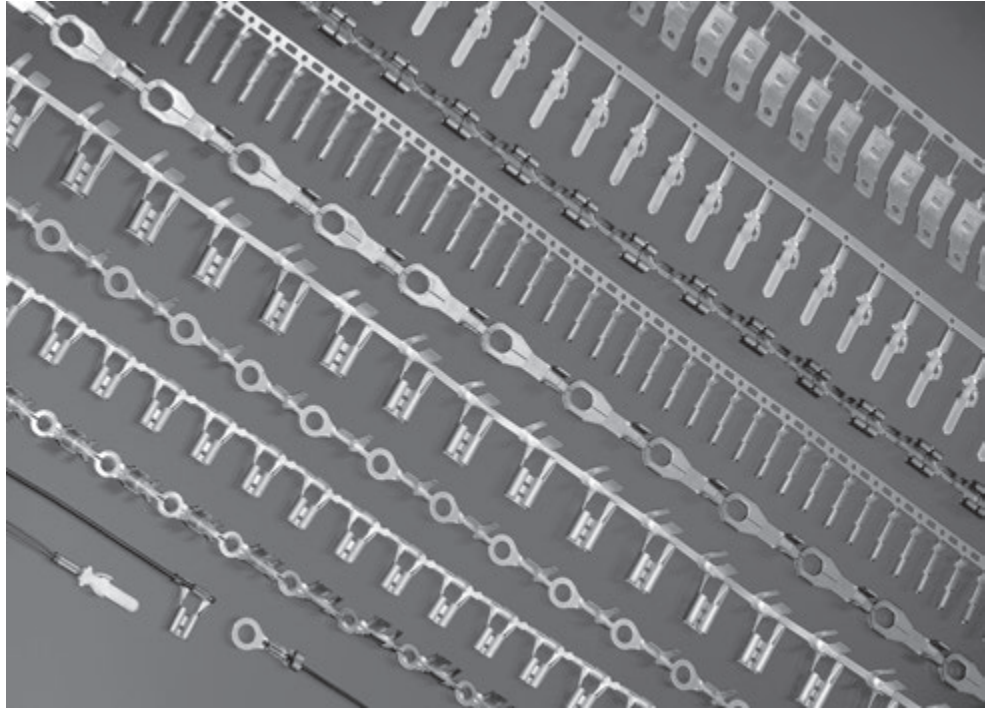

### Applications

- Motor windings
- Transformers
- Power supplies
- Starters and alternators

AMPLIVAR magnet wire terminals are designed to terminate copper and/or aluminum magnet wire. Terminals are insulation displacing; therefore, magnet wires do not require a separate prestripping operation.

The unique wire barrel design, with serrations and burrs, produces a superior metal-to-metal compression crimp with excellent tensile strength.

Terminals are available in a variety of ring tongue, FASTON straight, flag and stator receptacles and tab quick-disconnect style terminals.

Direct connection to magnet wire eliminates the need for separate stranded wire terminal connection to input/output devices.

Matched with automated application tooling allows high production rates for stripform terminals.

**Product specifications** describe the product qualification test results completed by TE for consideration of product use in a specific application. They are intended for the Design and Product Reliability Engineer.

- 108-16000 —AMPLIVAR ring tongue terminals
- 108-1718 —AMPLIVAR .125 blade terminals [Type A]

### Technical Documents

**Application Specifications** describe requirements for using the product in its intended application and or crimping information. They are intended for the Packaging and Design Engineer and the Machine Setup Person.

|          |                                                 |          |                                                           |          |                                                   |
|----------|-------------------------------------------------|----------|-----------------------------------------------------------|----------|---------------------------------------------------|
| 114-2145 | AMPLIVAR .125 Blade Terminals                   | 114-2144 | AMPLIVAR FASTON Series .250 Straight Receptacle Terminals | 114-2080 | AMPLIVAR Pin Receptacle Terminals [Type A]        |
| 114-2146 | AMPLIVAR FASTIN-FASTON Series 187 Tab Terminals | 114-2152 | AMPLIVAR Flag FASTON Series 187 & 250 Receptacle Terminal | 114-2128 | AMPLIVAR Stator Receptacle with FASTON Mating End |
| 114-2070 | AMPLIVAR FASTON Series 250 Tab Terminals        |          |                                                           |          |                                                   |

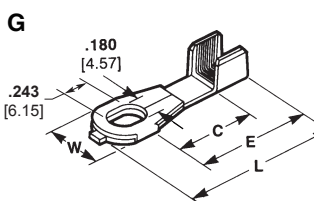
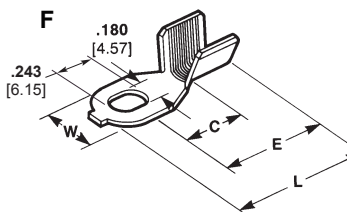
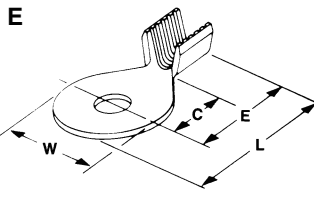
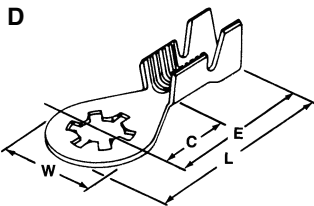
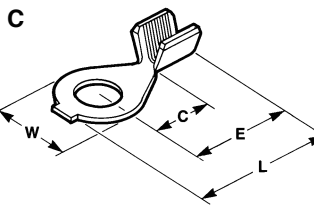
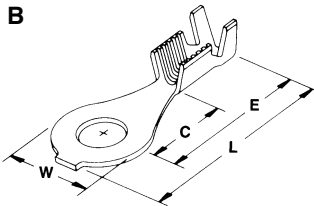
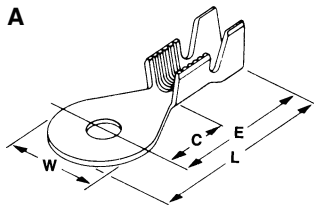

**AMPLIVAR Terminals** (Continued)

**Ring Tongue Terminals**

**Wire Size Range 29–22 AWG [0.287–0.643 mm]**

| Type | Insulation Dia. Range  | Hole Dia. | Stud Size | Stock Thk.   | Material         | Dimensions   |               |               |              | Part Number |
|------|------------------------|-----------|-----------|--------------|------------------|--------------|---------------|---------------|--------------|-------------|
|      |                        |           |           |              |                  | W            | L             | E             | C            |             |
| B    | .040-.060<br>1.02-1.52 | .197<br>5 | 10        | .020<br>0.51 | Tin Plated Brass | .342<br>8.69 | .833<br>21.16 | .662<br>16.81 | .312<br>7.92 | 63399-1     |

**Wire Size Range 23–19 AWG [0.574–0.912 mm]**

| Type | Insulation Dia. Range  | Hole Dia.    | Stud Size | Stock Thk.   | Material         | Dimensions   |               |               |              | Part Number |
|------|------------------------|--------------|-----------|--------------|------------------|--------------|---------------|---------------|--------------|-------------|
|      |                        |              |           |              |                  | W            | L             | E             | C            |             |
| B    | .100-.140<br>2.54-3.56 | .171<br>4.34 | 8         | .020<br>0.51 | Tin Plated Brass | .342<br>8.69 | .833<br>21.16 | .662<br>16.81 | .312<br>7.92 | 60321-2     |
| A    | .125-.165<br>3.18-4.19 | .171<br>4.34 | 8         | .020<br>0.51 | Tin Plated Brass | .300<br>7.62 | .700<br>17.78 | .550<br>13.97 | .230<br>5.84 | 60323-2     |
| B    | .100-.140<br>2.54-3.56 | .197<br>5    | 10        | .020<br>0.51 | Tin Plated Brass | .342<br>8.69 | .833<br>21.16 | .662<br>16.81 | .312<br>7.92 | 60319-2     |
| A    | .125-.165<br>3.18-4.19 | .197<br>5    | 10        | .020<br>0.51 | Tin Plated Brass | .300<br>7.62 | .695<br>17.65 | .545<br>13.84 | .230<br>5.84 | 60325-2     |

**Wire Size Range 22–18 AWG [0.643–1.024 mm]**

| Type | Insulation Dia. Range  | Hole Dia.    | Stud Size | Stock Thk.   | Material                  | Dimensions    |               |               |              | Part Number        |
|------|------------------------|--------------|-----------|--------------|---------------------------|---------------|---------------|---------------|--------------|--------------------|
|      |                        |              |           |              |                           | W             | L             | E             | C            |                    |
| B    | .125-.165<br>3.18-4.19 | .265<br>6.73 | 1/4       | .025<br>0.64 | Tin Plated Brass          | .420<br>10.67 | .872<br>22.15 | .662<br>16.81 | .312<br>7.92 | 63612-1            |
| E    | —                      | .145<br>3.58 | 6         | .025<br>0.64 | Tin Plated Brass          | .290<br>7.37  | .500<br>12.7  | .355<br>9.02  | .195<br>4.95 | 63649-1            |
| C    | —                      | .265<br>6.73 | 1/4       | .025<br>0.64 | Tin Plated Brass          | .420<br>10.67 | .702<br>17.83 | .492<br>12.5  | .312<br>7.92 | 62835-1            |
| E    | —                      | .171<br>4.34 | 8         | .025<br>0.64 | Brass<br>Tin Plated Brass | .290<br>7.37  | .500<br>12.7  | .355<br>9.02  | .195<br>4.95 | 63446-1<br>63446-2 |

**Wire Size Range 20–16 AWG [0.813–1.29 mm]**

| Type | Insulation Dia. Range  | Hole Dia.    | Stud Size | Stock Thk.   | Material         | Dimensions    |                |               |               | Part Number |
|------|------------------------|--------------|-----------|--------------|------------------|---------------|----------------|---------------|---------------|-------------|
|      |                        |              |           |              |                  | W             | L              | E             | C             |             |
| A    | .125-.165<br>3.18-4.19 | .171<br>4.34 | 8         | .020<br>0.51 | Tin Plated Brass | .300<br>7.62  | .695<br>17.65  | .545<br>13.84 | .230<br>5.84  | 60322-2     |
| H    | —                      | —            | 8         | .020<br>0.51 | Brass            | .340<br>8.64  | 1.220<br>30.98 | .660<br>16.76 | .500<br>12.7  | 505071-1    |
| L    | —                      | —            | 3/8       | .020<br>0.51 | Brass            | .625<br>15.88 | .939<br>23.85  | .627<br>15.93 | .467<br>11.86 | 505075-1    |
| M    | —                      | —            | 3/8       | .020<br>0.51 | Brass            | .645<br>16.38 | .950<br>24.12  | .627<br>15.93 | .467<br>11.86 | 505072-1    |

**Wire Size Range 18–14 AWG [1.024–1.628 mm]**

| Type | Insulation Dia. Range  | Hole Dia.    | Stud Size | Stock Thk.   | Material               | Dimensions   |               |               |              | Part Number |
|------|------------------------|--------------|-----------|--------------|------------------------|--------------|---------------|---------------|--------------|-------------|
|      |                        |              |           |              |                        | W            | L             | E             | C            |             |
| B    | .100-.140<br>2.54-3.56 | .171<br>4.34 | 8         | .020<br>0.51 | Brass                  | .342<br>8.69 | .833<br>21.16 | .662<br>16.81 | .312<br>7.92 | 60320-1     |
|      | .100-.140<br>2.54-3.56 | .171<br>4.34 | 8         | .020<br>0.51 | Tin Plated Brass       | .342<br>8.69 | .833<br>21.16 | .662<br>16.81 | .312<br>7.92 | 60320-2     |
|      | .100-.140<br>2.54-3.56 | .197<br>5    | 10        | .020<br>0.51 | Brass                  | .342<br>8.69 | .833<br>21.16 | .662<br>16.81 | .312<br>7.92 | 60318-1     |
| D    | .080-.120<br>2.03-3.05 | .173<br>4.39 | 8         | .028<br>0.71 | Lu-Bronze <sup>1</sup> | .370<br>9.4  | .915<br>23.24 | .730<br>18.54 | .380<br>9.65 | 485079-1    |
|      | .080-.120<br>2.03-3.05 | .185<br>4.7  | 8         | .028<br>0.71 | Lu-Bronze <sup>1</sup> | .365<br>9.27 | .882<br>22.4  | .700<br>17.78 | .380<br>9.65 | 485044-1    |

<sup>1</sup>High conductivity copper-tin-zinc alloy.

**Wire Range 17–13.5 AWG [1.151–1.78 mm]**

| Type | Insulation Dia. Range | Hole Dia. | Stud Size | Stock Thk.   | Material         | Dimensions   |               |               |              | Part Number |
|------|-----------------------|-----------|-----------|--------------|------------------|--------------|---------------|---------------|--------------|-------------|
|      |                       |           |           |              |                  | W            | L             | E             | C            |             |
| F    | —                     | —         | 8         | .020<br>0.51 | Brass            | .310<br>7.87 | .692<br>17.58 | .505<br>12.83 | .312<br>7.92 | 63147-1     |
|      | —                     | —         | 8         | .020<br>0.51 | Tin Plated Brass | .310<br>7.87 | .692<br>17.58 | .505<br>12.83 | .312<br>7.92 | 63147-2*    |

\*Available on request

**Wire Size Range 14–12 AWG [1.628–2.05 mm] or (2) 15 AWG [1.45 mm]**

| Type | Insulation Dia. Range | Hole Dia. | Stud Size | Stock Thk.   | Material | Dimensions   |               |               |               | Part Number |
|------|-----------------------|-----------|-----------|--------------|----------|--------------|---------------|---------------|---------------|-------------|
|      |                       |           |           |              |          | W            | L             | E             | C             |             |
| G    | —                     | —         | 8         | .025<br>0.64 | Brass    | .342<br>8.69 | .945<br>24.00 | .750<br>19.05 | .570<br>14.48 | 62755-1     |

Dimensions are in inches and millimeters unless otherwise specified. Values in brackets are metric equivalents.

Dimensions are shown for reference purposes only. Specifications subject to change.

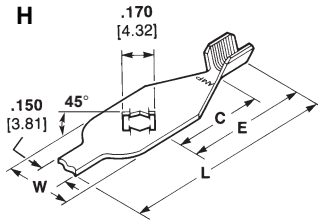
**AMPLIVAR Terminals (Continued)**
**Stud Retaining Terminals**

**Wire Size Range 13–11 AWG [1.83–2.3 mm]**

| Type | Insulation Dia. Range  | Hole Dia.    | Stud Size | Stock Thk.   | Material         | Dimensions   |               |               |              | Part Number |
|------|------------------------|--------------|-----------|--------------|------------------|--------------|---------------|---------------|--------------|-------------|
|      |                        |              |           |              |                  | W            | L             | E             | C            |             |
| A    | .085-.150<br>2.16-3.81 | .180<br>4.57 | 8         | .025<br>0.64 | Brass            | .342<br>8.69 | .833<br>21.16 | .662<br>16.81 | .312<br>7.92 | 61710-1     |
| C    | —                      | .180<br>4.57 | 8         | .025<br>0.64 | Tin Plated Brass | .342<br>8.69 | .665<br>16.89 | .495<br>12.57 | .312<br>7.92 | 350571-1    |
|      |                        | .197<br>5.00 | 10        | .025<br>0.64 | Tin Plated Brass | .342<br>8.69 | .665<br>16.89 | .495<br>12.57 | .312<br>7.92 | 640212-1    |

**Wire Range (1) 18 AWG [1.024 mm] and (1) 20.5 AWG [0.768 mm]**

| Type | Insulation Dia. Range | Hole Dia. | Stud Size | Stock Thk.   | Material | Dimensions   |               |               |              | Part Number |
|------|-----------------------|-----------|-----------|--------------|----------|--------------|---------------|---------------|--------------|-------------|
|      |                       |           |           |              |          | W            | L             | E             | C            |             |
| J    | —                     | —         | 8         | .020<br>0.51 | Brass    | .340<br>8.64 | .955<br>24.26 | .660<br>16.76 | .500<br>12.7 | 505044-1    |

**Wire Range (2) 17 AWG [1.51 mm] or (2) 15 AWG [1.45 mm]**

| Type | Insulation Dia. Range                                | Hole Dia.    | Stud Size | Stock Thk.   | Material         | Dimensions   |               |               |              | Part Number                                          |
|------|------------------------------------------------------|--------------|-----------|--------------|------------------|--------------|---------------|---------------|--------------|------------------------------------------------------|
|      |                                                      |              |           |              |                  | W            | L             | E             | C            |                                                      |
| B    | .150-.190<br>or (2) .115<br>3.18-4.83<br>or (2) 2.92 | .171<br>4.34 | 8         | .025<br>0.64 | Tin Plated Brass | .342<br>8.69 | .827<br>21.01 | .656<br>16.66 | .312<br>7.92 | 60752-2                                              |
|      |                                                      |              |           |              |                  |              |               |               |              | .150-.190<br>or (2) .115<br>3.18-4.83<br>or (2) 2.92 |

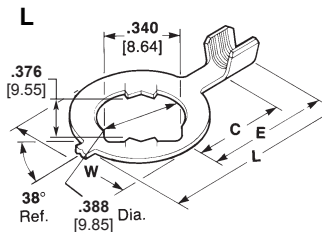
**Wire Range 16–13.5 AWG [1.29–1.78 mm]**

| Type | Insulation Dia. Range | Hole Dia. | Stud Size | Stock Thk.   | Material | Dimensions   |                |               |              | Part Number |
|------|-----------------------|-----------|-----------|--------------|----------|--------------|----------------|---------------|--------------|-------------|
|      |                       |           |           |              |          | W            | L              | E             | C            |             |
| K    | —                     | —         | 10        | .020<br>0.51 | Brass    | .340<br>8.64 | 1.220<br>30.99 | .660<br>16.76 | .500<br>12.7 | 505079-1    |

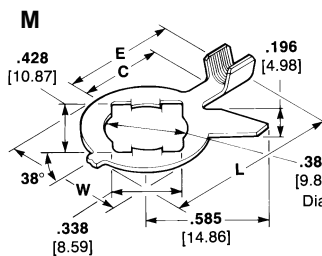
**Wire Range 14.5 AWG [1.539 mm]**

| Type | Insulation Dia. Range | Hole Dia. | Stud Size | Stock Thk.   | Material         | Dimensions  |               |              |              | Part Number  |
|------|-----------------------|-----------|-----------|--------------|------------------|-------------|---------------|--------------|--------------|--------------|
|      |                       |           |           |              |                  | W           | L             | E            | C            |              |
| N    | —                     | —         | 2         | .025<br>0.64 | Tin Plated Brass | .240<br>6.1 | .620<br>15.75 | .500<br>12.7 | .165<br>4.19 | 505036-1     |
|      |                       |           |           |              |                  |             |               |              |              | .025<br>0.64 |

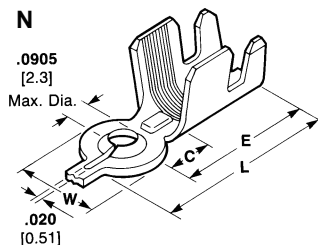
**Alternator Eyelet Terminal**

**Wire Range (2) 13 AWG [1.83 mm]**

| Type | Insulation Dia. Range  | Hole Dia.    | Stud Size | Stock Thk.   | Material         | Dimensions   |               |               |              | Part Number |
|------|------------------------|--------------|-----------|--------------|------------------|--------------|---------------|---------------|--------------|-------------|
|      |                        |              |           |              |                  | W            | L             | E             | C            |             |
| B    | .150-.190<br>3.81-4.83 | .171<br>4.34 | 8         | .025<br>0.64 | Tin Plated Brass | .342<br>8.69 | .827<br>21.00 | .656<br>16.66 | .312<br>7.92 | 63864-1     |

**AMPLIVAR Terminals** (Continued)

**125 Series Blade**

**Stock Thickness**

A = .013 [0.33]

B = .020 [0.51]

Mates with power blade receptacle terminals 61603-1, 61604-1, 770642-1 and 1217039-1

**Housings**

Contact TE engineering for housing options available



| Type | Magnet Wire Range |                 |                        |           | Material         | Material Thickness | Part Number |
|------|-------------------|-----------------|------------------------|-----------|------------------|--------------------|-------------|
|      | AWG               | mm <sup>2</sup> | Solid Dia.             | CMA       |                  |                    |             |
| A    | 27-20.5           | 0.10-0.45       | .015-.030<br>0.35-0.75 | 200-850   | Tin Plated Brass | .013<br>0.33       | 63871-1     |
|      | 24-18             | 0.2-0.8         | .020-.040<br>0.50-1.00 | 400-1600  | Tin Plated Brass | .013<br>0.33       | 63889-1     |
|      | 18.5-13.5         | 0.75-2.5        | .040-.070<br>0.50-1.80 | 1500-5000 | Tin Plated Brass | .016<br>0.41       | 63870       |
| B    | 27-20.5           | 0.10-0.45       | .015-.030<br>0.35-0.75 | 200-850   | Tin Plated Brass | .013<br>0.33       | 1217072-1   |
|      | 24-18             | 0.2-0.8         | .020-.040<br>0.50-1.00 | 400-1600  | Tin Plated Brass | .020<br>0.51       | 1217029-1   |
|      | 18.5-13.5         | 0.75-2.5        | .040-.070<br>0.50-1.80 | 1500-5000 | Tin Plated Brass | .020<br>0.51       | 1217073-1   |

**187 Series FASTON Tabs<sup>1</sup>**

**Board Thickness**

A = .062-.072 [1.57-1.83]

**Stock Thickness**

A = .020 [0.51]

B = .032 [0.81]



| Type | Wire Range |                 | Material         | Dim. L         | Part Number          |
|------|------------|-----------------|------------------|----------------|----------------------|
|      | AWG        | mm <sup>2</sup> |                  |                |                      |
| B    | 27-23      | 0.1-0.2         | Tin Plated Brass | .935<br>23.75  | 63484-1 <sup>2</sup> |
|      | 24-21      | 0.2-0.4         | Tin Plated Brass | .935<br>23.75  | 61440-3†             |
| A    | 22-16      | 0.3-1.4         | Tin Plated Brass | 1.015<br>25.78 | 62447-1              |
|      | 15-13      | 1.6-2.6         | Tin Plated Brass | .935<br>23.75  | 61442-3†             |
|      | 15-12      | 1.6-3.0         | Tin Plated Brass | 1.015<br>25.78 | 62445-1              |

<sup>2</sup> Varnish resist coating.

† These part numbers are available upon special request, contact TE engineering for details.

**250 Series FASTON Tabs<sup>1</sup>**

**Stock Thickness**

.032 [0.81]

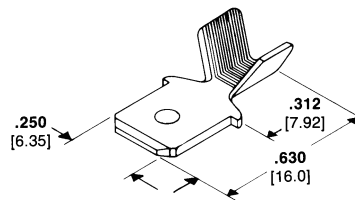

| Wire Range |                 | Material         | Part Number | Quick-Change Applicator <sup>3</sup> |
|------------|-----------------|------------------|-------------|--------------------------------------|
| AWG        | mm <sup>2</sup> |                  |             |                                      |
| 14-12      | 2.0-3.0         | Tin Plated Brass | 62922-12    | 466510-1                             |

<sup>2</sup> Varnish resist coating.

<sup>3</sup> Quick-change applicator for AMP-O-LECTRIC machine 565435-5. For AMPOMATOR machine and other machines not listed, contact TE.

<sup>1</sup>Mates with FASTON receptacles. See Catalog 82004.

**AMPLIVAR Terminals** (Continued)

**250 Series FASTON Tabs<sup>1</sup>**

(Continued)

**Stock Thickness**

.032 [0.81]

Mates with FASTON receptacles.  
See Catalog 82004.

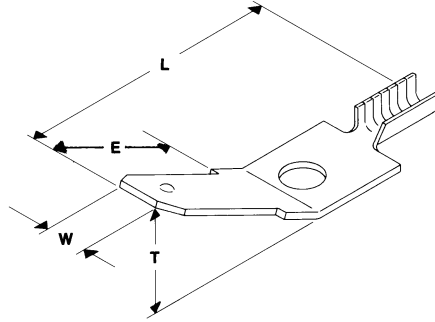

| Wire Range |                 | Material         | Dimensions   |               |               |     | Part Number |
|------------|-----------------|------------------|--------------|---------------|---------------|-----|-------------|
| AWG        | mm <sup>2</sup> |                  | W            | L             | E             | T   |             |
| 28-23.5    | 0.08-0.2        | Tin Plated Brass | .250<br>6.35 | .580<br>14.73 | .342<br>8.69  | 45° | 63136-1     |
| 25-19.5    | 0.16-0.6        | Tin Plated Brass | .250<br>6.35 | .650<br>16.51 | .450<br>11.43 | 30° | 63140-1     |
| 23-19      | 0.2-0.6         | Tin Plated Brass | .250<br>6.35 | .225<br>5.72  | .583<br>14.81 | 15° | 63165-1     |

**250 Series FASTON Receptacles<sup>1</sup>**

**Stock Thickness**

.016 [0.41]

Mates with FASTON tabs.  
See catalog 82004.



| Magnet Wire Range               |                                         | Insulation Diameter                        | Mating Tab Thk. | Material                  | Material Thickness | Part Number                                  | Applicator No.        |
|---------------------------------|-----------------------------------------|--------------------------------------------|-----------------|---------------------------|--------------------|----------------------------------------------|-----------------------|
| CMA                             | mm <sup>2</sup> Dia.                    |                                            |                 |                           |                    |                                              |                       |
| 24-19                           | 0.51-0.98                               | .050-.080<br>1.30-2.00                     | .020<br>0.51    | Brass<br>Tin Plated Brass | .016<br>0.41       | 63623-1 <sup>1</sup><br>63623-2 <sup>1</sup> | 567451-2 <sup>2</sup> |
| 23-19 or<br>(2) 24 or<br>(2) 26 | 0.60-0.98 or<br>(2) 0.57 or<br>(2) 0.45 | .050-.100<br>1.30-2.55                     | .025<br>0.64    | Brass                     | .016<br>0.41       | 62069-1                                      | 567343-2 <sup>2</sup> |
| 20-16 or<br>(2) 23 or<br>(2) 20 | 0.85-1.37 or<br>(2) 0.63 or<br>(2) 0.88 | .100-.140 or<br>(2) .060 Max.<br>2.55-3.55 | .032<br>[0.81]  | Brass<br>Tin Plated Brass | .016<br>0.41       | 60384-1<br>60384-2                           | 466010-1 <sup>2</sup> |
| 20-16                           | 0.85-1.37                               | .100-.140<br>2.55-3.55                     | .020<br>0.51    | Brass                     | .016<br>0.41       | 62080-1                                      | 466010-1 <sup>2</sup> |
| 18-14 or<br>(2) 17              | 1.02-1.71                               | .120-.170 or<br>(2) .060 Max.<br>3.05-4.30 | .032<br>[0.81]  | Tin Plated Brass          | .016<br>0.41       | 60385-2                                      | 466816-1 <sup>2</sup> |
| 18-14 or<br>(2) 19              | 1.02-1.71                               | .120-.170<br>3.05-4.30                     | .020<br>0.51    | Brass                     | .016<br>0.41       | 63622-1 <sup>1</sup>                         | 466816-1 <sup>2</sup> |
| 18-14 or<br>(2) 19              | 1.02-1.71                               | .120-.170<br>3.05-4.30                     | .020<br>0.51    | Brass                     | .016<br>0.41       | 1217835-1 <sup>1</sup>                       | 466816-1 <sup>2</sup> |

<sup>1</sup> Low insertion force

<sup>2</sup> Quick-change applicator for AMP-O-LECTRIC machine 565435-5.

**AMPLIVAR Terminals** (Continued)

**187 Series FASTON Flag Receptacles**

**Stock Thickness**

.016 [0.41]



| Magnet Wire Range<br>CMA | mm <sup>2</sup> Dia. | Insulation Diameter    | Mating Tab Thk. | Material         | Material Thickness | Part Number | Applicator No.        |
|--------------------------|----------------------|------------------------|-----------------|------------------|--------------------|-------------|-----------------------|
| 500-960                  | 0.56-0.79            | .020-.040<br>0.51-1.02 | .020<br>0.51    | Tin Plated Brass | .016<br>0.41       | 63942-1     | 566411-11             |
| 24-20 AWG                | 0.51-0.81            | .020-.040<br>0.51-1.02 | .032<br>0.81    | Tin Plated Brass | .016<br>0.41       | 1217624-1   | 566411-11             |
| 1500-2350                | 0.99-1.22            | .020-.040<br>0.51-1.02 | .020<br>0.51    | Tin Plated Brass | .016<br>0.41       | 63941-1     | 566410-11             |
| 2000-4050                | 1.14-1.63            | .020-.040<br>0.51-1.02 | .020<br>0.51    | Tin Plated Brass | .016<br>0.41       | 63940-1     | 680353-3 <sup>2</sup> |
| 2000-4050                | 1.14-1.63            | .020-.040<br>0.51-1.02 | .032<br>0.81    | Tin Plated Brass | .016<br>0.41       | 1217417-1   | 680353-3 <sup>2</sup> |

<sup>1</sup> Standard applicator for AMP-O-LECTRIC Model G splice terminator No. 356462-2.

<sup>2</sup> Quick-change applicator for AMP-O-LECTRIC Model G splice terminator No. 356462-1.

**250 Series FASTON Flag Receptacles**

**Stock Thickness**

.018 [0.45]

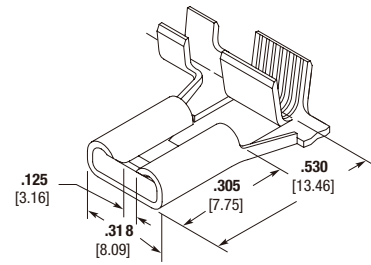
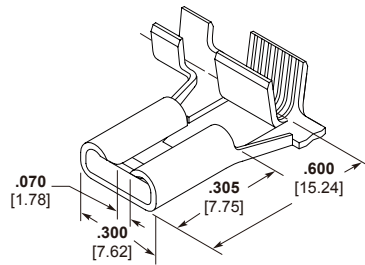

| Magnet wire range<br>CMA | mm <sup>2</sup> Dia. | Insulation Diameter    | Mating Tab Thk. | Material Thickness | Part Number | Applicator No. |
|--------------------------|----------------------|------------------------|-----------------|--------------------|-------------|----------------|
| 500-1900                 | —                    | .100-.120<br>2.54-3.05 | 6.35<br>0.81    | 0.0157<br>0.4      | 1742881-1   | 1855633        |
| 1000-2700                | —                    | .100-.120<br>2.54-3.05 | 6.35<br>0.81    | 0.0157<br>0.4      | 1742882-1   | 1855634        |
| 1500-4220                | —                    | .075-.125<br>1.90-3.18 | 6.35<br>0.81    | 0.0157<br>0.4      | 1742977-1   | 1855680        |
| 4000-8500                | —                    | .110-.150<br>2.79-3.81 | 6.35<br>0.81    | 0.0157<br>0.4      | 1742979-1   | 1855681        |

<sup>1</sup> Quick-change applicator for AMP-O-LECTRIC Model G splice terminator No. 356462-1.

**Pin Receptacles**

**Stock Thickness**

.016 [0.41]

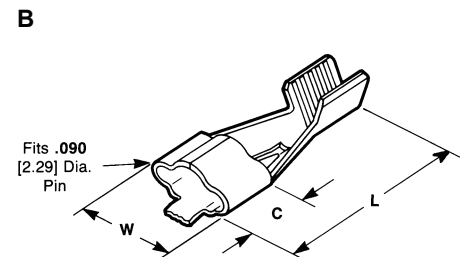
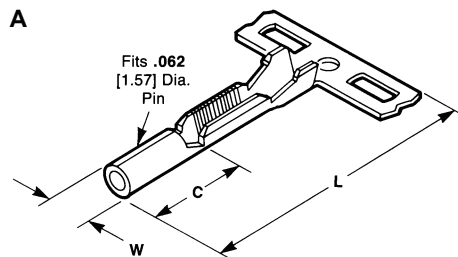

| Type | Wire Range |                 | Insulation Dia. Range  | Material                | Dimensions   |               |              | Part Number |
|------|------------|-----------------|------------------------|-------------------------|--------------|---------------|--------------|-------------|
|      | AWG        | mm <sup>2</sup> |                        |                         | W Max.       | L             | C            |             |
| A    | 29-22      | 0.07-0.3        | .040-.060<br>1.02-1.52 | Tin Plated Brass        | .084<br>2.13 | .590<br>14.99 | .195<br>4.95 | 63506-1     |
| B    | 21-16      | 0.4-1.4         | —                      | Tin Plated Phos. Bronze | .235<br>5.97 | .660<br>16.76 | .250<br>6.35 | 60177-2     |

**AMPLIVAR Terminals** (Continued)

**250 Series Stator Receptacles — 7 Serrations**



| AWG     | Magnet Wire Range |                        | CMA       | Mating Tab Thickness | Stock Thickness | Crimp Width  | Material         | Part Number |
|---------|-------------------|------------------------|-----------|----------------------|-----------------|--------------|------------------|-------------|
|         | mm <sup>2</sup>   | Solid Dia.             |           |                      |                 |              |                  |             |
| 27-22   | 0.10-0.3          | .014-.026<br>0.35-0.66 | 200-700   | .032<br>0.81         | .018<br>0.44    | .070<br>1.77 | Tin Plated Brass | 63480-1     |
| 21-15   | 0.4-1.6           | .028-.060<br>0.71-1.52 | 800-3600  | .032<br>0.81         | .018<br>0.44    | .110<br>2.79 | Tin Plated Brass | 62381-1     |
| 22-15.5 | 0.3-1.5           | .053-.086<br>1.35-2.18 | 2800-7400 | .032<br>0.81         | .018<br>0.44    | .155<br>3.94 | Tin Plated Brass | 63964-1     |

**Stator Terminal — Receptacle .250 x .032 [6.35 x 0.81]**

- ① **Stator Terminal** with Receptacle .250 x .032 [6.35 x 0.81]
- ② **Plastic Cavity**  
Production only according to TE Specifications (contact TE engineering for details).  
For design and material selection TE engineering **has to be** contacted before decision. The terminal is separated from the strip and placed automatically into the cavity.



- ③ **Wire Clamping Barrel**  
The magnet wire is positioned via posts into the AMPLIVAR crimp barrel and fixed inside clamping barrel.
- ④ **AMPLIVAR Terminal Crimp**  
The application equipment crimps the AMPLIVAR product connection and cuts the extending clamping barrel in one operation.

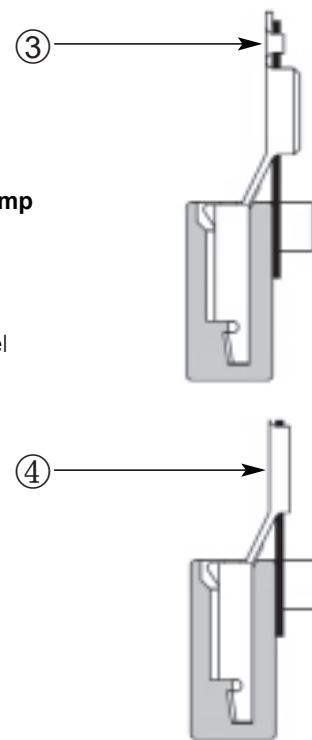

**Additional versions upon request.**  
**Application tooling for production line integrating available upon request.**



## Cluster Blocks

### Product Facts

- Connects to sealed hermetic headers
- Versions available to accept 2.29 [.090] and 3.18 [.125] header pins
- Accepts Lead wire range 18–16 AWG [0.8–1.4 mm<sup>2</sup>] and 14–12 AWG [2.0–3.0 mm<sup>2</sup>]
- AMPLIVAR product versions accept up to 3 copper or aluminum magnet wires without the need to remove insulation
- Impervious to many oils and refrigerants
- Insulation compatibility
- Housings available to accept standard and reversed header pin layouts
- Housing versions available for compressor interior and exterior
- High-performance electrical and mechanical contact
- High-impact resistant
- Assemblies accept pins from one side only to prevent reversed polarity
- High-speed application of pin receptacle terminals with automatic terminating machines and quick-change applicators for high volume production rates at the lowest installed cost
- Recognized under the Component Program of Underwriters Laboratories Inc., File No. E28476



TE features cluster blocks that offer manufacturers of air conditioning and refrigeration products a low-cost, fully insulated, quick-connect means for electrically connecting sealed hermetic header pins on compressors.

Cluster blocks feature high impact resistance to shock and abuse, and long-life performance in the presence of oils and refrigerants. Since the connectors accept pins from only one side, the danger of reversing polarity at the time of installation is prevented.



The one-piece housings are molded from thermoplastic polyester. The connector accepts 2.29 [.090] and 3.18 [.125] diameter pin sizes in either standard or reverse pin layouts.

Housings accept both lead wire and AMPLIVAR direct connect pin receptacle

terminals. These are precision formed and available on reels for highspeed application.

High retention pin receptacle terminals are available to provide optimum terminal retention housings.



Typical Assembly

PRODUCT SPECIFICATIONS:  
108-2008, 108-5205 & 108-5541

APPLICATION SPECIFICATIONS:  
114-2019 & 114-5235

**Cluster Blocks 2.29 [.090] Pin Size (Lead Wire and Direct Connect)**

**Housings**

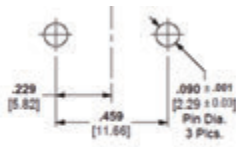

**Pin Location A**



**Pin Location B, C and D**

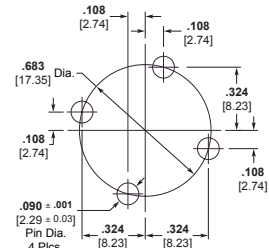

**Pin Location E**



| Type                                      | Header Pin Circle Dia. | Dim L            | Dim W           | Dim H           | Dim K           | Material / Use <sup>1</sup> | Accepts Receptacle Style | Part Number | Notes |
|-------------------------------------------|------------------------|------------------|-----------------|-----------------|-----------------|-----------------------------|--------------------------|-------------|-------|
|                                           | mm / inch              | mm / inch        | mm / inch       | mm / inch       | mm / inch       |                             |                          |             |       |
| 2 Position with Standoff                  | 13.46<br>[.530]        | 22.45<br>[.884]  | 21.08<br>[.830] | 14.23<br>[.560] | N/A             | PBT Interior                | A, B & C                 | 1969357-1   |       |
|                                           |                        | 31.50<br>[1.240] | 18.05<br>[.710] | 8.15<br>[.320]  | 21.35<br>[.840] | PBT Interior                | A, B & C                 | 360050-1    |       |
|                                           |                        | 31.00<br>[1.220] | 17.65<br>[.695] | 6.60<br>[.260]  | 20.85<br>[.820] | PBT Interior                | A, B & C                 | 521078-1    |       |
| B<br>3 Position<br>Center Forward         | 13.46<br>[.530]        | 30.48<br>[1.200] | 17.65<br>[.695] | 7.87<br>[.310]  | 20.40<br>[.803] | PBT Exterior                | A, B & C                 | 1380145-1   | 2     |
|                                           |                        | 30.48<br>[1.200] | 17.65<br>[.695] | 7.87<br>[.310]  | 20.40<br>[.803] | PBT Exterior                | A, B & C                 | 1380145-2   | 3     |
|                                           |                        | 30.48<br>[1.200] | 17.65<br>[.695] | 9.70<br>[.382]  | 20.40<br>[.803] | PBT Exterior                | A, B & C                 | 2232327-1   | 3     |
|                                           |                        | 30.48<br>[1.200] | 17.65<br>[.695] | 9.70<br>[.382]  | 20.40<br>[.803] | PA6+GF Exterior             | A, B & C                 | 2232327-2   | 4     |
|                                           |                        | 30.48<br>[1.200] | 17.65<br>[.695] | 9.70<br>[.382]  | 20.40<br>[.803] | PBT Exterior                | A, B & C                 | 2232326-1   | 3     |
|                                           |                        | 30.48<br>[1.200] | 17.65<br>[.695] | 9.70<br>[.382]  | 20.40<br>[.803] | PA6+GF Exterior             | A, B & C                 | 2232326-2   | 4     |
| C<br>3 Position<br>Center Back            | 13.46<br>[.530]        | 30.80<br>[1.21]  | 17.80<br>[.701] | 7.40<br>[.0291] | 20.40<br>[.803] | PBT Exterior                | A, B & C                 | 235280-1    |       |
|                                           |                        | 31.10<br>[1.225] | 20.55<br>[.810] | 8.15<br>[.320]  | 21.35<br>[.840] | PBT Interior                | A, B & C                 | 360033-1    |       |
|                                           |                        | 30.50<br>[1.200] | 17.65<br>[.695] | 7.85<br>[.310]  | 20.40<br>[.805] | PBT Interior                | A, B & C                 | 281006-4    |       |
|                                           |                        | 30.50<br>[1.200] | 17.70<br>[.697] | 7.90<br>[.311]  | 20.40<br>[.805] | PBT Exterior                | A, B & C                 | 880631-5    | 2     |
|                                           |                        | 30.50<br>[1.200] | 17.70<br>[.697] | 7.80<br>[.307]  | 20.40<br>[.805] | PA6+GF Exterior             | A, B & C                 | 1955415-1   | 4     |
|                                           |                        | 31.60<br>[1.244] | 22.70<br>[.893] | 9.30<br>[.366]  | 21.50<br>[.846] | PBT Filled Interior         | D & E                    | 171370-3    |       |
| D<br>3 Position<br>Center Back Extra Wide | 13.46<br>[.530]        | 31.60<br>[1.244] | 22.70<br>[.893] | 9.30<br>[.366]  | 21.50<br>[.846] | PBT Filled Exterior         | D & E                    | 171370-5    | 3     |
|                                           |                        | 31.60<br>[1.244] | 22.70<br>[.893] | 9.30<br>[.366]  | 21.50<br>[.846] | PA6+GF Exterior             | D & E                    | 171370-6    | 4     |
|                                           |                        | 28.10<br>[1.110] | 22.70<br>[.893] | 7.60<br>[.299]  | 18.10<br>[.712] | PBT Filled Exterior         | F                        | 2825082-1   | 5     |
| Economy Models                            | 13.46<br>[.530]        | 28.10<br>[1.110] | 22.70<br>[.893] | 7.60<br>[.299]  | 18.10<br>[.712] | PBT Filled Exterior         | F                        | 2825082-2   | 4     |
|                                           |                        | 28.10<br>[1.110] | 22.70<br>[.893] | 7.60<br>[.299]  | 18.10<br>[.712] | PBT Filled Exterior         | F                        | 2825082-2   | 4     |
| E<br>4 Position                           | 17.35<br>[.683]        | 37.85<br>[1.490] | 22.85<br>[.900] | 9.00<br>[.355]  | 21.45<br>[.845] | PBT Interior                | A, B & C                 | 1217262-1   |       |

Notes: 1. Interior use designates that the material can be subjected to refrigerants and lubricants often found in a compressor. 3. Flammability rating UL94 V-0  
 Consult TE Connectivity Product specification for additional information. 4. Flammability rating UL94 V-0. Glow Wire compliant to 750°C with No Flame per IEC 60335-1.  
 2. Flammability rating UL94 V-2 5. Flammability rating UL94 HB

**Cluster Blocks 2.29 [.090] Pin Size (Lead Wire and Direct Connect)**

**Pin Receptacles**

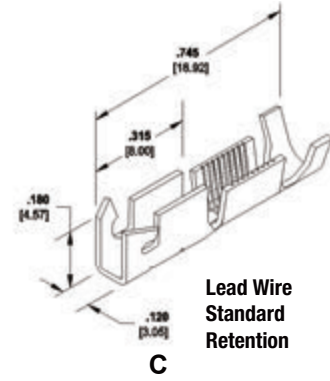
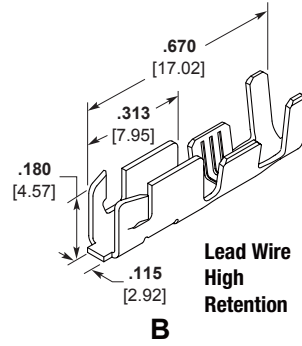
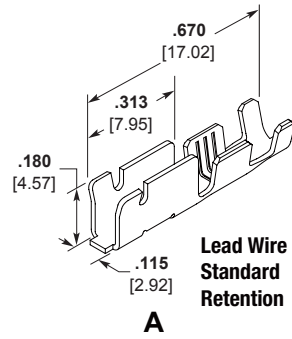

Cluster Blocks

| Type                                                   | Lead Wire Size           | Magnet Wire Size             | Crimp Width    | Insulation Dia             | Crimp Width    | Material                               | Part Number | Notes |
|--------------------------------------------------------|--------------------------|------------------------------|----------------|----------------------------|----------------|----------------------------------------|-------------|-------|
|                                                        | mm <sup>2</sup> / AWG    | mm <sup>2</sup> / CMA        |                |                            |                |                                        |             |       |
| A<br>Lead Wire<br>Standard Retention                   | 0.30 - .75<br>[22 - 18]  |                              | 2.03<br>0.080  | 1.30 - 2.40<br>.051 - .095 | 3.05<br>0.120  | Tin Plated Phos<br>Bronze <sup>1</sup> | 1599105-1   |       |
|                                                        | 0.80 - 1.3<br>[18 - 16]  |                              | 2.79<br>0.110  | 1.50 - 2.50<br>.060 - .100 | 3.56<br>0.140  | Tin Plated Phos<br>Bronze <sup>1</sup> | 62131-3     |       |
|                                                        |                          |                              | 2.79<br>0.110  | 2.30 - 4.30<br>.090 - .170 | 4.57<br>0.180  | Tin Plated Phos<br>Bronze <sup>1</sup> | 63448-1     |       |
|                                                        |                          | 0.26-0.77<br>[400 - 1600]    | 2.270<br>0.090 | 1.50 - 2.55<br>0.06 - .100 | 3.560<br>0.140 | Tin Plated Phos<br>Bronze <sup>1</sup> | 1742981-1   |       |
| C<br>AMPLIVAR Direct Connect<br>High Retention Product |                          | 0.77 - 2.43<br>[1600 - 4800] | 2.79<br>0.110  | 1.90 - 3.20<br>.075 - .125 | 3.94<br>0.155  | Tin Plated Phos<br>Bronze <sup>1</sup> | 1742964-1   | 3     |
| D<br>Lead Wire<br>Oval Contact                         | 0.50 - 1.25<br>[20 - 16] |                              | 2.29<br>0.090  | 2.00 - 3.40<br>.080 - .134 | 3.81<br>0.150  | Tin Plated Phos<br>Bronze <sup>1</sup> | 170063-2    | 2     |
| E<br>AMPLIVAR Short Barrel<br>Oval Contact             |                          | 0.11 - 0.73<br>[225 - 1445]  | 1.78<br>0.070  | 0.90 - 2.00<br>.035 - .079 | 3.3<br>0.130   | Tin Plated Phos<br>Bronze <sup>1</sup> | 1123655-1   | 2, 4  |
|                                                        |                          | 0.77 - 2.13<br>[1600 - 4200] | 2.79<br>0.110  | 2.00 - 2.90<br>.080 - .114 | 3.81<br>0.150  | Tin Plated Phos<br>Bronze <sup>1</sup> | 353937-1    | 2, 4  |
| F<br>Lead Wire<br>Oval Contact<br>Economy Model        | 0.50 - 1.25<br>[20 - 16] |                              | 2.29<br>0.090  | 2.00 - 3.40<br>.080 - .134 | 3.81<br>0.150  | Tin Plated Phos<br>Bronze <sup>1</sup> | 2825083-1   | 5     |

Notes: 1. May contain an equivalent copper alloy.  
 2. Requires extra wide type D housing.  
 3. Connects up to 3 Copper or aluminum magnet wires without stripping insulation.  
 4. Connects up to 2 copper magnets without stripping insulation.  
 5. Requires extra wide type D, Economy Model housing.

**Cluster Blocks 3.18 [.125] Pin Size (Lead Wire and Direct Connect)**

**Housings**

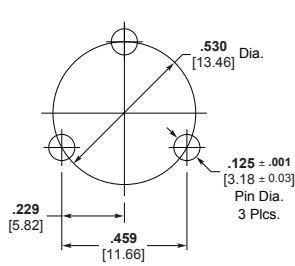

**Pin Location  
A and B**

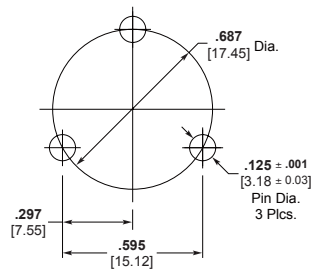

**Pin Location  
C and D**

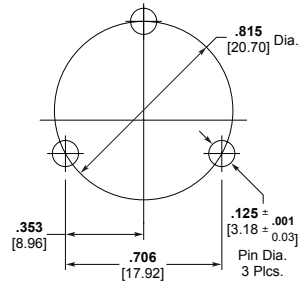

**Pin Location  
E**

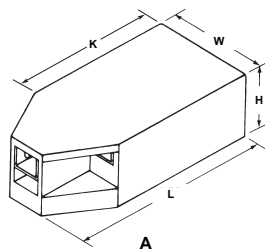

**A**

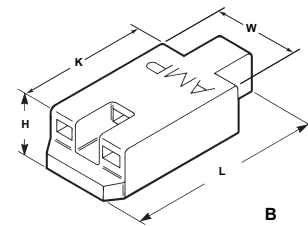

**B**

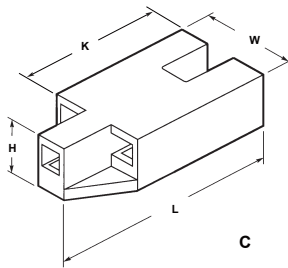

**C**

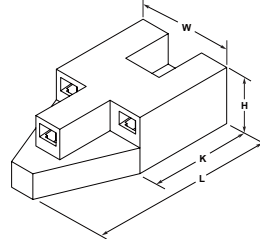

**D**

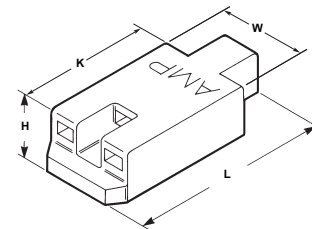

**E**

| Type                              | Header Pin Circle Dia. | Dim L     | Dim W     | Dim H     | Dim K     | Material / Use <sup>1</sup> | Accepts Receptacle Style | Part Number |
|-----------------------------------|------------------------|-----------|-----------|-----------|-----------|-----------------------------|--------------------------|-------------|
|                                   | mm / inch              | mm / inch | mm / inch | mm / inch | mm / inch |                             |                          |             |
| A<br>3 Position<br>Center Forward | 13.46<br>[.530]        | 44.60     | 19.45     | 11.95     | 31.17     | PBT Interior                | A, B, C & D              | 360052-1    |
|                                   |                        | [1.755]   | [0.765]   | [0.470]   | [1.227]   |                             |                          |             |
| B<br>3 Position<br>Center Back    | 13.46<br>[.530]        | 44.60     | 19.45     | 13.35     | 31.17     | PBT Interior                | A, B, C & D              | 1217181-1   |
|                                   |                        | [1.755]   | [0.765]   | [.525]    | [1.227]   |                             |                          |             |
| C<br>3 Position<br>Center Forward | 17.45<br>[.687]        | 44.60     | 19.45     | 11.95     | 31.10     | PBT Interior                | A, B, C & D              | 360051-1    |
|                                   |                        | [1.755]   | [0.765]   | [0.470]   | [1.225]   |                             |                          |             |
| D<br>3 Position<br>Center Back    | 17.45<br>[.687]        | 47.25     | 19.45     | 13.35     | 31.10     | PBT Interior                | A, B, C & D              | 1217200-1   |
|                                   |                        | [1.860]   | [.765]    | [.525]    | [1.225]   |                             |                          |             |
| E<br>3 Position<br>Center Forward | 20.70<br>[.815]        | 40.50     | 22.75     | 9.65      | 27.45     | PBT Interior                | A, B, C & D              | 520995-1    |
|                                   |                        | [1.595]   | [.895]    | [.380]    | [1.080]   |                             |                          |             |
| D<br>3 Position<br>Center Back    | 17.45<br>[.687]        | 43.95     | 22.75     | 15.60     | 27.45     | PBT Interior                | A, B, C & D              | 1217186-1   |
|                                   |                        | [1.730]   | [.895]    | [.615]    | [1.080]   |                             |                          |             |
| E<br>3 Position<br>Center Forward | 20.70<br>[.815]        | 47.00     | 22.75     | 15.60     | 31.10     | PBT Interior                | A, B, C & D              | 1217187-1   |
|                                   |                        | [1.850]   | [.895]    | [.615]    | [1.225]   |                             |                          |             |
| E<br>3 Position<br>Center Forward | 20.70<br>[.815]        | 50.15     | 25.80     | 15.00     | 26.65     | PBT Interior                | A, B, C & D              | 1217261-1   |
|                                   |                        | [1.975]   | [1.015]   | [.590]    | 1.05      |                             |                          |             |

Notes: 1. Interior use designates that the material can be subjected to refrigerants and lubricants often found in a compressor. Consult TE Connectivity product specification for additional information.

**Cluster Blocks 3.18 [.125] Pin Size (Lead Wire and Direct Connect)** (Continued)

**Pin Receptacles**

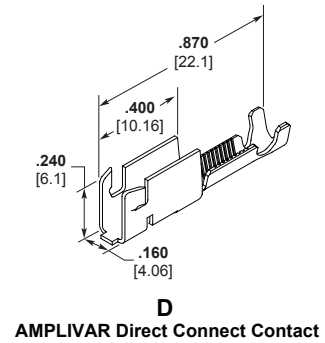
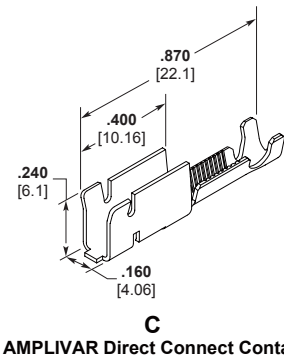
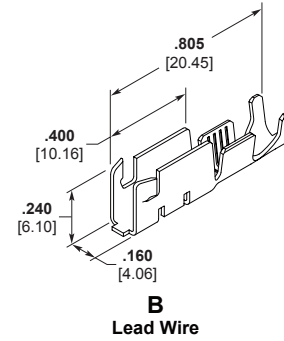

| Type                                               | Lead Wire Size                         | Magnet Wire Size           | Crimp Width   | Insulation Dia                           | Crimp Width   | Material                               | Part Number | Notes |
|----------------------------------------------------|----------------------------------------|----------------------------|---------------|------------------------------------------|---------------|----------------------------------------|-------------|-------|
|                                                    | mm <sup>2</sup> / AWG                  | mm <sup>2</sup> / CMA      | mm / inch     | mm / inch                                | mm / inch     |                                        |             |       |
| A<br>Lead Wire<br>Standard Retention               | 0.75 - 1.5<br>[18 - 16]                |                            | 2.79<br>0.110 | 2.30 - 3.30<br>.090 - .130               | 3.94<br>0.155 | Tin Plated<br>Phos Bronze <sup>3</sup> | 62244-3     | 2     |
|                                                    | 2.0 - 6.0                              |                            | 3.56          | 3.30 - 4.30                              | 4.57          | Tin Plated<br>Phos Bronze <sup>3</sup> | 62243-3     | 2     |
|                                                    | 14 - 10                                |                            | 0.140         | .130 - .170                              | 0.180         |                                        |             |       |
| B<br>Lead Wire<br>High Retention                   | 0.32-0.82 or 2x0.32<br>[22-18 or 2x22] |                            | 2.29<br>0.090 | 2.79 or 2x2.29 Max<br>.110 or 2x.090 Max | 3.56<br>0.140 | Tin Plated<br>Phos Bronze <sup>3</sup> | 1742657-1   | 2     |
|                                                    | 0.75 - 1.5<br>[18 - 16]                |                            | 2.79<br>0.110 | 2.30 - 3.30<br>.090 - .130               | 3.94<br>0.155 | Tin Plated<br>Phos Bronze <sup>3</sup> | 1217176-1   | 2     |
|                                                    | 2.0 - 6.0<br>[14 - 10]                 |                            | 3.56<br>0.140 | 3.30 - 4.30<br>.130 - .170               | 4.57<br>0.180 | Tin Plated<br>Phos Bronze <sup>3</sup> | 1217175-1   | 2     |
| C<br>AMPLIVAR Direct Connect<br>Standard Retention |                                        | 0.20 - 0.81<br>400 - 1600  | 2.27<br>0.090 | 1.50 - 2.55<br>.060 - .100               | 3.56<br>0.140 | Tin Plated<br>Phos Bronze <sup>3</sup> | 63453-1     | 2, 4  |
|                                                    |                                        | 0.76 - 2.13<br>1500 - 4200 | 2.79<br>0.110 | 1.90 - 3.20<br>.075 - .125               | 3.94<br>0.155 | Tin Plated<br>Phos Bronze <sup>3</sup> | 63454-1     | 2, 4  |
|                                                    |                                        | 2.00 - 4.30<br>4000 - 8500 | 3.56<br>0.140 | 2.30 - 4.30<br>.090 - .170               | 4.32<br>0.170 | Tin Plated<br>Phos Bronze <sup>3</sup> | 63455-1     | 2, 4  |
|                                                    |                                        | 0.20 - 0.81<br>400 - 1600  | 2.27<br>0.090 | 1.50 - 2.55<br>.060 - .100               | 3.56<br>0.140 | Tin Plated<br>Phos Bronze <sup>3</sup> | 1217172-1   | 2, 4  |
| D<br>AMPLIVAR Direct Connect<br>High Retention     |                                        | 0.76 - 2.13<br>1500 - 4200 | 2.79<br>0.110 | 1.90 - 3.20<br>.075 - .125               | 3.94<br>0.155 | Tin Plated<br>Phos Bronze <sup>3</sup> | 1217174-1   | 2, 4  |
|                                                    |                                        | 2.00 - 4.30<br>4000 - 8500 | 3.56<br>0.140 | 2.30 - 4.30<br>.090 - .170               | 4.32<br>0.170 | Tin Plated<br>Phos Bronze <sup>3</sup> | 1217173-1   | 2, 4  |

Notes: 1. Material shown is for reference only. May contain an equivalent copper alloy.  
 2. Receptacle must be contained in a housing listed on the previous page for proper performance.  
 3. Stand-alone receptacle can be used with or without a housing.  
 4. Connects up to 3 copper or aluminum magnet wires without removing the insulation.

Cluster Blocks



**MTM Crimpband Splices** This product line is not recommended for new designs, as the application machines are no longer manufactured.

**Product Facts**

- Made from a continuous coil of ribbon connector material
- Magnet wires MTM Crimpband splices have machine-piercing serrations designed for displacing magnet wire insulation.
- Available in brass, tin-plated brass, and copper-nickel alloy material
- Make parallel or pigtail connections on same machine
- 100% of Crimpband material is used in scrap free terminations
- Crimpband material coupled with appropriate toolsets accommodate specific CMA ranges
- Produced in TE equipment on your production floor
- Meets UL 486C crimp tensile requirements

**Applications**

- Motors windings and connections
- Coil connections
- Transformer windings and connections
- Lighting ballasts
- Power supplies



TE features the MTM Crimpband system that is comprised of two key features: the semi-automatic termination machine and a reel of MTM Crimpband material.

In a one-step crimping operation, the machine feeds, cuts, forms and crimps the material to provide a low-cost, high reliability crimp connection.

The MTM Crimpband splices are formed during the crimping process from

machined longitudinal grooved material that pierces magnet wire varnish film insulation during crimping.

MTM Crimpband splices are specifically designed to terminate magnet wire to itself or in combination with standard solid or stranded lead wire.

Three magnet wires maximum can be terminated together with stranded lead wire in one splice.

TE provides a wide range of toolset types and Crimpband splices to meet various production requirements.

Depending on your specific application, MTM Crimpband splices are available in 7, 9, 11 and 13 serration versions for terminations in the 400 to 13,000 CMA range.

When aluminum magnet wire is used, MTM Crimpband splices must be tin plated.

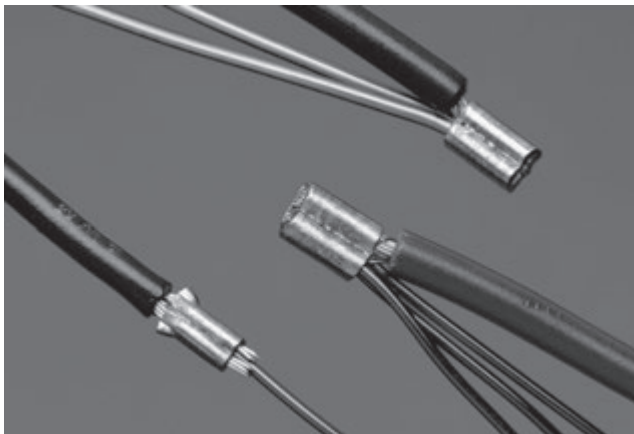



**MTM Crimpband Splices** (Continued) This product line is not recommended for new designs, as the application machines are no longer manufactured.

**MTM Crimpband Interconnection System**

**How the System Operates**

- ① **Feed (Magnet Wire Connector Material)**  
Machine feeds strip until the strip hits the wire stop.
- ② **Shear (Blank Length)**  
The strip is cut by the cutter block former bar insert tooling.
- ③ **Bend (Crimp Formed)**  
The former bar drives the cut strip over the anvil, bending the cut strip into an upside down "U".
- ④ **Wire (Placement)**  
In pigtail and parallel (Thru) splices magnet wires must be placed on top of the lead wire.
- ⑤ **Crimp (Crimp Formed)**  
The anvil retracts as the driver takes the formed strip down into the clincher.

**Notes:** To insure that the proper Crimpband splice is chosen, TE recommends the following:

1. Submit 10 samples of wire combinations and/or components to be crimped with any special requirements to your TE sales representative.
2. Pull-out force and/or millivolt drop tests will be performed to insure that the proper Crimpband material, toolset and crimp heights are recommended.
3. Tooling and testing will be documented on a Material & Tooling Sheet (M & T sheet).
4. Crimpband material quotes, tooling quotes and samples will be submitted to the customer.

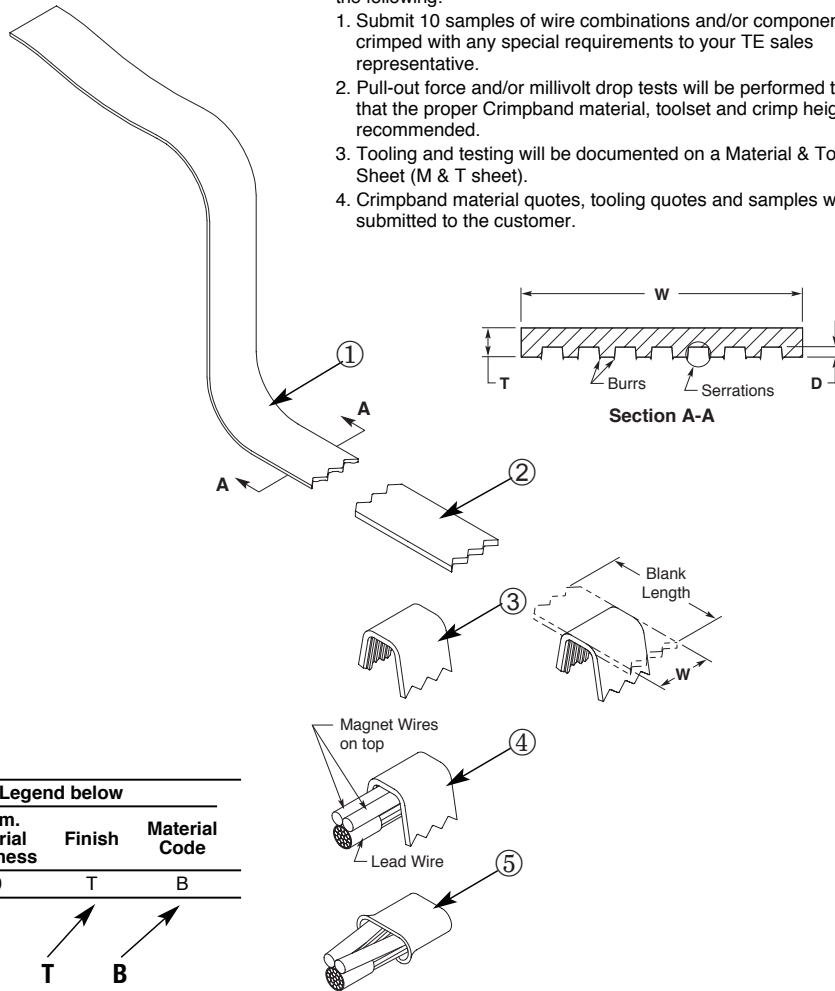

**Connector Specification Code**

| Machine Basis | See Figure 1 and/or Legend below |                        |                           |        |               |
|---------------|----------------------------------|------------------------|---------------------------|--------|---------------|
|               | B.L. Dim. Tooling Size           | W Dim. Connector Width | T Dim. Material Thickness | Finish | Material Code |
| L             | 092                              | 6R                     | 20                        | T      | B             |

**Splice No. Example:** L 092 6R 20 T B

**Legend**

| Machine Basis |          |         |
|---------------|----------|---------|
| L             | P        | G*      |
| Leased        | Purchase | General |

\* Customer has their own Tooling

| Tooling Size Code | Blank Length B/L (Nom.) |
|-------------------|-------------------------|
| 032               | .167                    |
| 032/036           | .228                    |
| 036               | .224                    |
| 045               | .246                    |
| 051               | .267                    |
| 061               | .292                    |
| 061/076           | .324                    |
| 076               | .339                    |
| 076/092           | .361                    |
| 092               | .379                    |
| 092/125           | .413                    |
| 125               | .446                    |
| 125/160           | .485                    |
| 125/165           | .506                    |
| 165               | .546                    |

**Note:** For B/L above, .546 consult TE for tooling size code.

| Connector Width Code W |               | D Serration Depth |
|------------------------|---------------|-------------------|
| 4R                     | 5 Serrations  | .138              |
| 6R                     | 7 Serrations  | .154              |
| 8R                     | 9 Serrations  | .194              |
| 10R                    | 11 Serrations | .234              |

| Material Thickness Code | T ±.002 Dim. | D Serration Depth |
|-------------------------|--------------|-------------------|
| 12                      | .012         | .005              |
| 14                      | .014         | .005              |
| 16                      | .016         | .007              |
| 20                      | .020         | .007              |
| 25                      | .025         | .007              |

| Material Code | Material/Finish             |
|---------------|-----------------------------|
| B             | CDA 260 Brass               |
| A             | CDA 725 Copper/Nickel Alloy |
| TB            | Pre-Tin over CDA 260 Brass  |

| Wire Size AWG | UL486C Pull Out Force Requirements Underwriters Laboratory (lbs.) |
|---------------|-------------------------------------------------------------------|
| 26            | 3                                                                 |
| 24            | 5                                                                 |
| 22            | 8                                                                 |
| 20            | 10                                                                |
| 18            | 10                                                                |
| 16            | 15                                                                |
| 14            | 25                                                                |
| 12            | 35                                                                |
| 10            | 40                                                                |

Crimband

**MTM Crimpband Splices** (Continued) This product line is not recommended for new designs, as the application machines are no longer manufactured.

**11 Serrations**

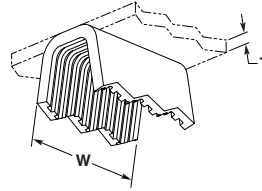

| AWG/<br>mm <sup>2</sup> | Wire Range<br>Solid Dia. | CMA<br>Range | Stock<br>Thk. (T) | Mat'l<br>Width (W) | Material            | Toolset | Part<br>Number | Descriptive<br>X-ref |
|-------------------------|--------------------------|--------------|-------------------|--------------------|---------------------|---------|----------------|----------------------|
| 14½-11½<br>1.80-4.00    | .059-.087<br>1.50-2.21   | 3500-7500    | .025<br>0.64      | .234<br>5.94       | Brass               | 125/165 | 1601842-1      | P125/<br>16510R25B   |
| 14½-11½<br>1.80-4.00    | .059-.087<br>1.50-2.21   | 3500-7500    | .025<br>0.64      | .234<br>5.94       | Tin Plated<br>Brass | 125/165 | 1601705-1      | L125/<br>16510R25TB  |
| 13½-10½<br>2.54-4.50    | .071-.097<br>1.70-2.46   | 4500-9500    | .025<br>0.64      | .234<br>5.94       | Brass               | 165/200 | 1601847-1      | P165/<br>20010R25B   |
| 13½-10½<br>2.54-4.50    | .071-.097<br>1.70-2.46   | 4500-9500    | .025<br>0.64      | .234<br>5.94       | Tin Plated<br>Brass | 165/200 | 1601848-1      | P165/<br>20010R25TB  |

**9 Serrations**



| AWG/<br>mm <sup>2</sup> | Wire Range<br>Solid Dia. | CMA<br>Range | Stock<br>Thk. (T) | Mat'l<br>Width (W) | Material            | Toolset | Part<br>Number | Descriptive<br>X-ref |
|-------------------------|--------------------------|--------------|-------------------|--------------------|---------------------|---------|----------------|----------------------|
| 24-20<br>0.20-0.50      | .020-.033<br>0.51-0.84   | 400-1100     | .016<br>0.41      | .194<br>4.93       | Tin Plated<br>Brass | 032/036 | 1601794-1†     | P032/<br>0368R16TB   |
| 20½-16<br>0.45-1.30     | .030-.051<br>0.76-1.29   | 900-2600     | .018<br>0.46      | .194<br>4.93       | Tin Plated<br>Brass | 061     | 1601607-1†     | L0618R16TB           |
| 20½-16<br>0.45-1.30     | .030-.051<br>0.76-1.29   | 900-2600     | .018<br>0.46      | .194<br>4.93       | Brass               | 061     | 1601608-1      | L0618R20B            |
| 20½-16<br>0.45-1.30     | .030-.051<br>0.76-1.29   | 900-2600     | .018<br>0.46      | .194<br>4.93       | Tin Plated<br>Brass | 061     | 1601814-1†     | P0618R20TB           |
| 18-14<br>0.80-2.00      | .040-.063<br>1.02-1.60   | 1600-4000    | .016<br>0.41      | .194<br>4.93       | Tin Plated<br>Brass | 076     | 1601824-1      | P0768R16TB           |
| 18-14<br>0.80-2.00      | .040-.063<br>1.02-1.60   | 1600-4000    | .020<br>0.51      | .194<br>4.93       | Tin Plated<br>Brass | 076     | 1601857-1      | PO768R20TB           |
| 18-14<br>0.80-2.00      | .040-.063<br>1.02-1.60   | 1800-4600    | .020<br>0.51      | .194<br>4.93       | Brass               | 076/092 | 1601823-1      | P076/<br>0928R20B    |
| 18-14<br>0.80-2.00      | .040-.063<br>1.02-1.60   | 1800-4600    | .020<br>0.51      | .194<br>4.93       | Tin Plated<br>Brass | 076/092 | 1601639-1      | L076/<br>0928R20TB   |
| 16-12<br>1.30-3.46      | .051-.078<br>1.29-1.98   | 2600-6100    | .020<br>0.51      | .194<br>4.93       | Brass               | 092/125 | 1601833-1      | P092/<br>1258R20B    |
| 16-12<br>1.30-3.46      | .051-.078<br>1.29-1.98   | 2600-6100    | .020<br>0.51      | .194<br>4.93       | Tin Plated<br>Brass | 092/125 | 1601677-1      | L092/<br>1258R20TB   |
| 16-12<br>1.30-3.46      | .051-.078<br>1.29-1.98   | 2600-6100    | .025<br>0.64      | .194<br>4.93       | Brass               | 092/125 | 1601678-1†     | L092/<br>1258R25B    |
| 16-12<br>1.30-3.46      | .051-.078<br>1.29-1.98   | 2600-6100    | .025<br>0.64      | .194<br>4.93       | Tin Plated<br>Brass | 092/125 | 1601835-1†     | P092/<br>1258R25TB   |
| 15½-12<br>1.54-3.46     | .055-.082<br>1.40-2.10   | 3000-6750    | .016<br>0.41      | .194<br>4.93       | Brass               | 125     | 1601717-1†     | L1258R16B            |
| 15½-12<br>1.54-3.46     | .055-.082<br>1.40-2.10   | 3000-6750    | .016<br>0.41      | .194<br>4.93       | Tin Plated<br>Brass | 125     | 1601718-1      | L1258R16TB           |
| 15½-12<br>1.54-3.46     | .055-.082<br>1.40-2.10   | 3000-6750    | .020<br>0.51      | .194<br>4.93       | Brass               | 125     | 1601846-1      | P1258R20B            |
| 15½-12<br>1.54-3.46     | .055-.082<br>1.40-2.10   | 3000-6750    | .025<br>0.64      | .194<br>4.93       | Brass               | 125     | 1601719-1      | L1258R25B            |
| 14½-11½<br>1.80-4.00    | .059-.087<br>1.50-2.21   | 3500-7500    | .025<br>0.64      | .194<br>4.93       | Brass               | 125/165 | 1601706-1      | L125/<br>1658R25B    |
| 14½-11½<br>1.80-4.00    | .059-.087<br>1.50-2.21   | 3500-7500    | .025<br>0.64      | .194<br>4.93       | Tin Plated<br>Brass | 125/165 | 1601707-1      | L125/<br>1658R25TB   |
| 14-11<br>2.00-4.20      | .063-.092<br>1.60-2.34   | 4000-8500    | .025<br>0.64      | .194<br>4.93       | Tin Plated<br>Brass | 165     | 1601750-1†     | L1658R25TB           |
| 11½-9<br>4.00-6.50      | .084-.114<br>2.13-2.90   | 7000-13000   | .025<br>0.64      | .194<br>4.93       | Tin Plated<br>Brass | 200/202 | 1601761-1      | L200/<br>2028R25TB   |

† These part numbers are available upon special request; contact TE engineering for details.

**MTM Crimpband Splices** (Continued) This product line is not recommended for new designs, as the application machines are no longer manufactured.

**7 Serrations**

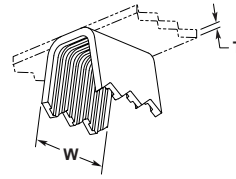

| AWG/<br>mm <sup>2</sup> | Wire Range<br>Solid Dia. | CMA<br>Range | Stock<br>Thk. (T) | Mat'l<br>Width (W) | Material            | Toolset | Part<br>Number | Descriptive<br>X-ref             |
|-------------------------|--------------------------|--------------|-------------------|--------------------|---------------------|---------|----------------|----------------------------------|
| 27½-21<br>0.09-0.40     | .013-.028<br>0.33-0.71   | 170-800      | .012<br>0.30      | .154<br>3.91       | Brass               | 032     | 1601800-1      | P0326R12BUF <sup>1</sup>         |
| 24-20<br>0.20-0.50      | .020-.033<br>0.51-0.84   | 400-1100     | .012<br>0.30      | .154<br>3.91       | Brass               | 032/036 | 1601539-1      | L032/<br>0366R12B                |
| 24-20<br>0.20-0.50      | .020-.033<br>0.51-0.84   | 400-1100     | .012<br>0.30      | .154<br>3.91       | Cu Ni               | 032/036 | 1601538-1      | L032/<br>0366R12AUF <sup>1</sup> |
| 24-20<br>0.20-0.50      | .020-.033<br>0.51-0.84   | 400-1100     | .016<br>0.41      | .154<br>3.91       | Brass               | 032/036 | 1601540-1      | L032/<br>0366R16B                |
| 24-20<br>0.20-0.50      | .020-.033<br>0.51-0.84   | 400-1100     | .016<br>0.41      | .154<br>3.91       | Tin Plated<br>Brass | 032/036 | 1601793-1      | P032/<br>0366R16TB               |
| 22-19<br>0.38-0.60      | .024-.036<br>0.70-0.91   | 600-1300     | .016<br>0.41      | .154<br>3.91       | Brass               | 045     | 1601559-1      | L0456R16B                        |
| 22-19<br>0.38-0.60      | .024-.036<br>0.70-0.91   | 600-1300     | .020<br>0.51      | .154<br>3.91       | Brass               | 045     | 1601560-1†     | L0456R20B                        |
| 20½-16<br>0.45-1.30     | .030-.051<br>0.76-1.29   | 900-2600     | .016<br>0.41      | .154<br>3.91       | Brass               | 061     | 1601604-1      | L0616R16B                        |
| 20½-16<br>0.45-1.30     | .030-.051<br>0.76-1.29   | 900-2600     | .016<br>0.41      | .154<br>3.91       | Tin Plated<br>Brass | 061     | 1601606-1      | L0616R16TB                       |
| 18-14<br>0.80-2.00      | .040-.063<br>1.02-1.60   | 1600-4000    | .016<br>0.41      | .154<br>3.91       | Brass               | 076     | 1601644-1      | L0766R16B                        |
| 18-14<br>0.80-2.00      | .040-.063<br>1.02-1.60   | 1600-4000    | .016<br>0.41      | .154<br>3.91       | Tin Plated<br>Brass | 076     | 1601646-1†     | L0766R16TB                       |
| 18-14<br>0.80-2.00      | .040-.063<br>1.02-1.60   | 1600-4000    | .020<br>0.51      | .154<br>3.91       | Brass               | 076     | 1601647-1†     | L0766R20B                        |
| 17½-13½<br>0.95-2.54    | .042-.068<br>1.07-1.80   | 1800-4600    | .016<br>0.41      | .154<br>3.91       | Brass               | 076/092 | 1601637-1      | L076/<br>0926R16BX               |
| 16½-13<br>1.10-2.60     | .047-.072<br>1.19-1.83   | 2200-5200    | .016<br>0.41      | .154<br>3.91       | Tin Plated<br>Brass | 092     | 1601683-1      | L0926R16TB                       |
| 16-12<br>1.30-3.46      | .051-.078<br>1.29-1.98   | 2600-6100    | .016<br>0.41      | .154<br>3.91       | Tin Plated<br>Brass | 092/125 | 1601675-1      | L092/<br>1256R16TB               |
| 16-12<br>1.30-3.46      | .051-.078<br>1.29-1.98   | 2600-6100    | .020<br>0.51      | .154<br>3.91       | Brass               | 092/125 | 1601832-1      | P092/<br>1256R20B                |
| 15½-12<br>1.54-3.46     | .055-.082<br>1.40-2.10   | 3000-6750    | .012<br>0.30      | .154<br>3.91       | Brass               | 125     | 1601844-1      | P1256R12B                        |
| 15½-12<br>1.54-3.46     | .055-.082<br>1.40-2.10   | 3000-6750    | .016<br>0.41      | .154<br>3.91       | Brass               | 125     | 1601845-1      | P1256R16B                        |
| 15½-12<br>1.54-3.46     | .055-.082<br>1.40-2.10   | 3000-6750    | .016<br>0.41      | .154<br>3.91       | Tin Plated<br>Brass | 125     | 1601716-1†     | L1256R16TB                       |

<sup>1</sup> UF designates Ultra-Fine serrations which are recommended for applications using wire size 28 AWG [0.32 mm] or smaller.

† These part numbers are available upon special request; contact TE engineering for details.

Crimband

**RTM Crimpband Splices**

**This product line is not recommended for new designs, as the application machines are no longer manufactured.**

**Product Facts**

- Made from a continuous coil of "Ribbon Connector" material
- RTM Crimpband have grooved serrations for improved axial retention.
- Available in brass, tin-plate d brass and copper-nickel alloy (CA725) materia I
- Make parallel or pigtail connections on same machine
- Used for electrical and non-electrical connections.
- 100% of RTM Crimpband material is used in scrap free terminations
- Crimpband material coupled with appropriate toolsets accommodate specific CMA ranges
- Produced in TE equipment on your production floor
- Meets UL 486C crimp tensile requirements

**Applications**

- Stranded and solid wire-to-wire connections
- Light bulb LED assembly
- Switch lead assembly
- Resistor lead assembly
- Printed circuit board lead assembly
- Flex-film lead assembly
- Glass reed switch lead assembly

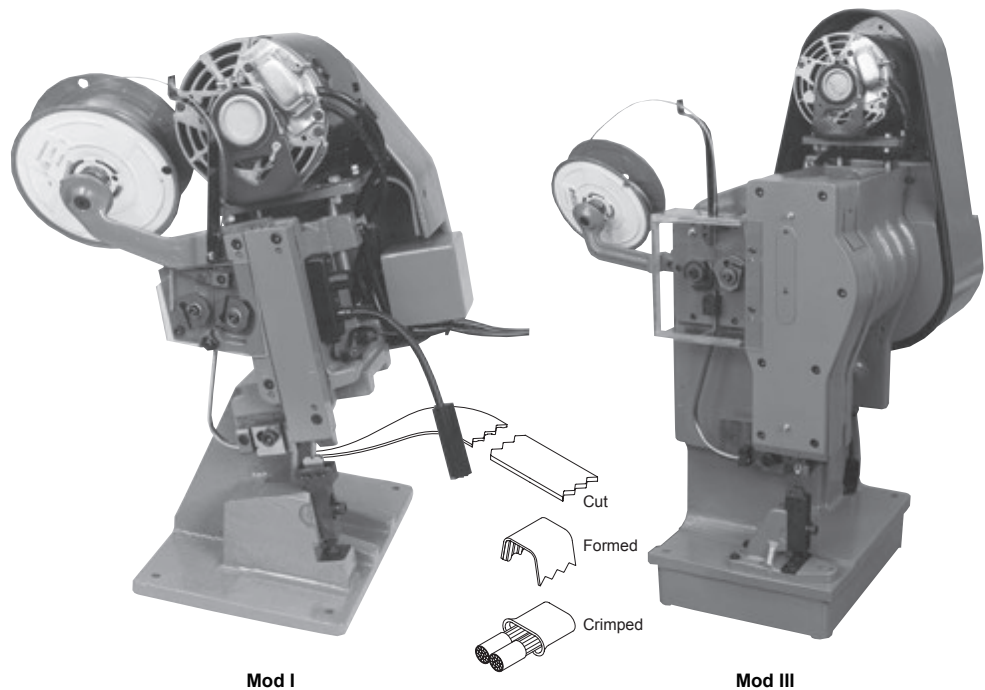

TE features the RTM Crimpband system that is comprised of two key features: the semi-automatic termination machine and a reel of RTM Crimpband material.

In a one-step crimping operation, the machine feeds, cuts, forms and crimps the material to provide a low-cost, high reliability crimp connection.

The RTM Crimpband splices are formed during the crimping process from

milled longitudinal groove material that produce rolled, rounded serrations.

They are designed to terminate pre-stripped stranded and solid wire conductors together as well as wire conductors to switch tabs, resistors, printed circuit board, flex circuit and light bulb LED and glass reed switch assemblies, etc.

The flexibility of the RTM Crimpband system provides opportunity for use in custom applications for

either electrical and / or mechanical connections.

TE provides a wide range of toolset types and crimpband splices to meet various production requirements.

Depending on your specific application, RTM Crimpband splices are available in 3, 6, 7, 8, 9, 10 14 and 20 ridge serration versions for terminations in the 170 to 13,000 CMA range.

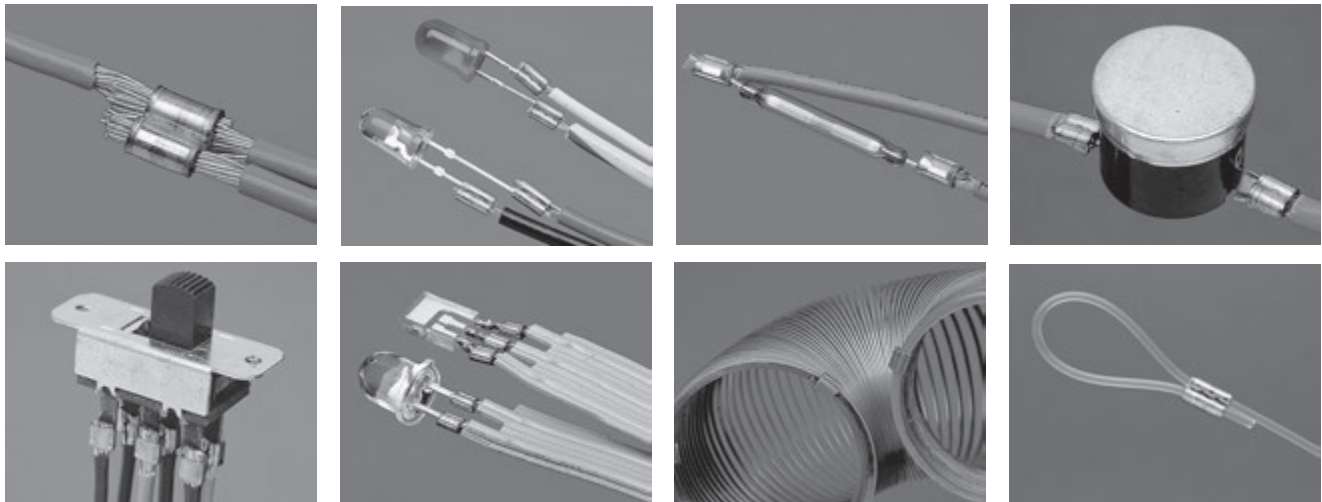

**RTM Crimpband Splices (Continued)** This product line is not recommended for new designs, as the application machines are no longer manufactured.

**RTM Crimpband Interconnection System**

**How the System Operates**

- ① **Feed (Ribbon Connector Material)**  
Machine feeds strip until the strip hits the wire stop.
- ② **Shear (Blank Length)**  
The strip is cut by the cutter block former bar insert tooling.
- ③ **Bend (Crimp Formed)**  
The former bar drives the cut strip over the anvil, bending the cut strip into an upside down "U".
- ④ **Wire (Placement)**  
Pigtails and parallel (Thru) splice terminations are made on the same machine.
- ⑤ **Crimp (Crimp Formed)**  
The anvil retracts as the driver takes the formed strip down into the clincher.

**Notes:** To insure that the proper Crimpband splice is chosen, TE recommends the following:

1. Submit 10 samples of wire combinations and/or components to be crimped with any special requirements to your TE sales representative.
2. Pull-out force and/or millivolt drop tests will be performed to insure that the proper Crimpband material, toolset and crimp heights are recommended.
3. Tooling and testing will be documented on a Material & Tooling Sheet (M & T sheet).
4. Crimpband material quotes, tooling quotes and samples will be submitted to the customer.



**Connector Specification Code**

See Figure 1 and/or Legend below

| Machine Basis | B.L. Dim. Tooling Size | W Dim. Connector Width | T Dim. Material Thickness | Material |
|---------------|------------------------|------------------------|---------------------------|----------|
| L             | 092                    | F                      | 20                        | TCRS     |

**Splice No. Example:** L      092      F      20      TCRS

**Legend**

| Machine Basis     |                         |
|-------------------|-------------------------|
| L                 | P                       |
| Leased            | Purchase                |
| Tooling Size Code | Blank Length B/L (Nom.) |
| 032               | .167                    |
| 032/036           | .228                    |
| 036               | .224                    |
| 045               | .246                    |
| 051               | .267                    |
| 061               | .292                    |
| 061/076           | .324                    |
| 076               | .339                    |
| 076/092           | .361                    |
| 092               | .379                    |
| 092/125           | .413                    |
| 125               | .446                    |
| 125/160           | .485                    |
| 125/165           | .506                    |
| 165               | .546                    |

| Connector Width Code | W Dim. | N No. of Ridges |
|----------------------|--------|-----------------|
| B                    | .076   | 3               |
| C                    | .138   | 6               |
| D                    | .154   | 7               |
| E                    | .185   | 8               |
| F                    | .216   | 9               |
| G                    | .234   | 10              |
| H                    | .247   | 10              |
| L                    | .086   | 3               |
| M                    | .330   | 14              |
| N                    | .500   | 20              |
| P                    | .114   | 5               |

| Material Thickness Code | T±.002 Dim. |
|-------------------------|-------------|
| 12                      | .012        |
| 16                      | .016        |
| 18                      | .018        |
| 20                      | .020        |
| 22                      | .022        |
| 24                      | .024        |
| 25                      | .025        |

| Material Code | Material/Finish                    |
|---------------|------------------------------------|
| B             | CDA 260 Brass                      |
| A             | CDA 725 Copper/Nickel Alloy        |
| TB            | Pre-Tin over CDA 260 Brass         |
| TCRS          | 1010 Cold Rolled Steel, Tin Plated |
| SS            | 301 or 302 Stainless Steel         |
| ST            | Stainless Steel, Tin Plated        |

| Wire Size AWG | UL486C Pull Out Force Requirements Underwriters Laboratory (lbs.) |
|---------------|-------------------------------------------------------------------|
| 26            | 3                                                                 |
| 24            | 5                                                                 |
| 22            | 8                                                                 |
| 20            | 10                                                                |
| 18            | 10                                                                |
| 16            | 15                                                                |
| 14            | 25                                                                |
| 12            | 35                                                                |
| 10            | 40                                                                |

**Note:** For B/L above, .546 consult factory for tooling size code

Crimband

**RTM Crimpband Splices** (Continued)

**This product line is not recommended for new designs, as the application machines are no longer manufactured.**

**20 Ridges**

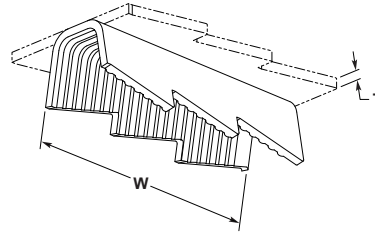

| AWG/<br>mm <sup>2</sup> | Wire Range<br>Solid Dia. | CMA<br>Range | Stock<br>Thk. (T) | Mat'l<br>Width (W) | Material            | Toolset | Part<br>Number | Descriptive<br>X-ref |
|-------------------------|--------------------------|--------------|-------------------|--------------------|---------------------|---------|----------------|----------------------|
| 11½-9<br>4.00-6.50      | .084-.114<br>2.13-2.90   | 7000-13000   | .020<br>0.51      | .500<br>12.70      | Tin Plated<br>Brass | 200/202 | 1601771-1      | L200/202N20TB        |

**14 Ridges**

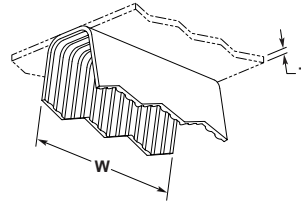

| AWG/<br>mm <sup>2</sup> | Wire Range<br>Solid Dia. | CMA<br>Range | Stock<br>Thk. (T) | Mat'l<br>Width (W) | Material | Toolset | Part<br>Number | Descriptive<br>X-ref |
|-------------------------|--------------------------|--------------|-------------------|--------------------|----------|---------|----------------|----------------------|
| 22-19<br>0.38-0.60      | .024-.036<br>0.61-0.91   | 600-1300     | .012<br>0.30      | .330<br>8.38       | Cu Ni    | 045     | 1601577-1†     | L045M12A             |
| 22-19<br>0.38-0.60      | .024-.036<br>0.61-0.91   | 600-1300     | .012<br>0.30      | .330<br>8.38       | Brass    | 045     | 1601578-1      | L045M12B             |

† These part numbers are available upon special request; contact TE engineering for details.

**10 Ridges**

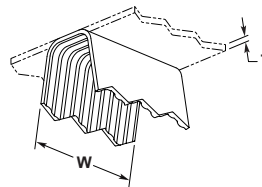

| AWG/<br>mm <sup>2</sup> | Wire Range<br>Solid Dia. | CMA<br>Range | Stock<br>Thk. (T) | Mat'l<br>Width (W) | Material | Toolset | Part<br>Number | Descriptive<br>X-ref |
|-------------------------|--------------------------|--------------|-------------------|--------------------|----------|---------|----------------|----------------------|
| 22-19<br>0.38-0.60      | .024-.036<br>0.61-0.91   | 600-1300     | .012<br>0.30      | .234<br>5.94       | Brass    | 045     | 1601575-1      | L045G12B             |
| 21-18½<br>0.40-0.75     | .028-.039<br>0.71-0.99   | 800-1500     | .016<br>0.41      | .234<br>5.94       | Cu Ni    | 051     | 1601593-1†     | L051G16A             |
| 20½-16<br>0.45-1.30     | .030-.051<br>0.76-1.29   | 900-2600     | .012<br>0.30      | .234<br>5.94       | Brass    | 061     | 1601632-1†     | L061G12B             |
| 20½-16<br>0.45-1.30     | .030-.051<br>0.76-1.29   | 900-2600     | .020<br>0.51      | .234<br>5.94       | Brass    | 061     | 1601633-1      | L061G20B             |
| 11½-9<br>4.00-6.50      | .084-.114<br>2.13-2.90   | 7000-13000   | .020<br>0.51      | .234<br>5.94       | Brass    | 200/202 | 1601853-1      | P200/<br>202G20B     |
| 11½-9<br>4.00-6.50      | .084-.114<br>2.13-2.90   | 7000-13000   | .025<br>0.64      | .234<br>5.94       | Brass    | 200/202 | 1601769-1      | L200/<br>202G25BX    |

† These part numbers are available upon special request; contact TE engineering for details.



**RTM Crimpband Splices** (Continued) This product line is not recommended for new designs, as the application machines are no longer manufactured.

**9 Ridges**



| AWG/<br>mm <sup>2</sup> | Wire Range<br>Solid Dia.      | CMA<br>Range | Stock<br>Thk. (T)   | Mat'l<br>Width (W)  | Material           | Toolset | Part<br>Number | Descriptive<br>X-ref |
|-------------------------|-------------------------------|--------------|---------------------|---------------------|--------------------|---------|----------------|----------------------|
| 22-19<br>0.38-0.60      | <b>.024-.036</b><br>0.61-0.91 | 600-1300     | <b>.012</b><br>0.30 | <b>.216</b><br>5.49 | Stainless<br>Steel | 045     | 1601807-1      | P045F12SS            |
| 20½-16<br>0.45-1.30     | <b>.030-.051</b><br>0.76-1.29 | 900-2600     | <b>.012</b><br>0.30 | <b>.216</b><br>5.49 | Stainless<br>Steel | 061     | 1601520-1      | G061F12SS            |

**8 Ridges**



| AWG/<br>mm <sup>2</sup> | Wire Range<br>Solid Dia.      | CMA<br>Range | Stock<br>Thk. (T)   | Mat'l<br>Width (W)  | Material          | Toolset | Part<br>Number | Descriptive<br>X-ref |
|-------------------------|-------------------------------|--------------|---------------------|---------------------|-------------------|---------|----------------|----------------------|
| 24-20<br>0.20-0.50      | <b>.020-.033</b><br>0.51-0.84 | 400-1100     | <b>.012</b><br>0.30 | <b>.185</b><br>4.70 | Cu Ni             | 032/036 | 1601553-1      | L032/<br>036E12A     |
| 18-14<br>0.80-2.00      | <b>.040-.063</b><br>1.02-1.60 | 1600-4000    | <b>.018</b><br>0.46 | <b>.185</b><br>4.70 | Tin Plated<br>CRS | 076     | 1601669-1      | L076E18TCRS          |
| 11½-9<br>4.00-6.50      | <b>.084-.114</b><br>2.13-2.90 | 7000-13000   | <b>.024</b><br>0.61 | <b>.185</b><br>4.70 | Brass             | 200/202 | 1601768-1      | L200/<br>202E24B     |

**7 Ridges**



| AWG/<br>mm <sup>2</sup> | Wire Range<br>Solid Dia.      | CMA<br>Range | Stock<br>Thk. (T)   | Mat'l<br>Width (W)  | Material            | Toolset | Part<br>Number | Descriptive<br>X-ref |
|-------------------------|-------------------------------|--------------|---------------------|---------------------|---------------------|---------|----------------|----------------------|
| 24-20<br>0.20-0.50      | <b>.020-.033</b><br>0.51-0.84 | 400-1100     | <b>.012</b><br>0.30 | <b>.154</b><br>3.91 | Brass               | 032/036 | 1601550-1      | L032/<br>036D12B     |
| 24-20<br>0.20-0.50      | <b>.020-.033</b><br>0.51-0.84 | 400-1100     | <b>.016</b><br>0.41 | <b>.154</b><br>3.91 | Cu Ni               | 032/036 | 1601551-1      | L032/<br>036D16A     |
| 24-20<br>0.20-0.50      | <b>.020-.033</b><br>0.51-0.84 | 400-1100     | <b>.016</b><br>0.41 | <b>.154</b><br>3.91 | Brass               | 032/036 | 1601797-1      | P032/<br>036D16B     |
| 24-20<br>0.20-0.50      | <b>.020-.033</b><br>0.51-0.84 | 400-1100     | <b>.016</b><br>0.41 | <b>.154</b><br>3.91 | Tin Plated<br>Brass | 032/036 | 1601798-1      | P032/<br>036D16TB    |
| 22-19<br>0.38-0.60      | <b>.024-.036</b><br>0.61-0.91 | 600-1300     | <b>.012</b><br>0.30 | <b>.154</b><br>3.91 | Brass               | 045     | 1601572-1      | L045D12B             |
| 22-19<br>0.38-0.60      | <b>.024-.036</b><br>0.61-0.91 | 600-1300     | <b>.016</b><br>0.41 | <b>.154</b><br>3.91 | Cu Ni               | 045     | 1601573-1      | L045D16A             |

Crimband

**RTM Crimpband Splices** (Continued)

This product line is not recommended for new designs, as the application machines are no longer manufactured.

**7 Ridges** (Continued)



| AWG/<br>mm <sup>2</sup> | Wire Range<br>Solid Dia. | CMA<br>Range | Stock<br>Thk. (T) | Mat'l<br>Width (W) | Material               | Toolset | Part<br>Number | Descriptive<br>X-ref |
|-------------------------|--------------------------|--------------|-------------------|--------------------|------------------------|---------|----------------|----------------------|
| 22-19<br>0.38-0.60      | .024-.036<br>0.61-0.91   | 600-1300     | .016<br>0.41      | .154<br>3.91       | Brass                  | 045     | 1601507-1†     | G045D16B             |
| 21-18½<br>0.40-0.75     | .028-.039<br>0.71-0.99   | 800-1500     | .012<br>0.30      | .154<br>3.91       | Brass                  | 051     | 1601587-1      | L051D12B             |
| 21-18½<br>0.40-0.75     | .028-.039<br>0.71-0.99   | 800-1500     | .016<br>0.41      | .154<br>3.91       | Brass                  | 051     | 1601588-1      | L051D16B             |
| 21-18½<br>0.40-0.75     | .028-.039<br>0.71-0.99   | 800-1500     | .020<br>0.51      | .154<br>3.91       | Nickel Plated<br>Steel | 051     | 1601591-1      | L051D20NPS           |
| 21-18½<br>0.40-0.75     | .028-.039<br>0.71-0.99   | 800-1500     | .020<br>0.51      | .154<br>3.91       | Tin Plated<br>CRS      | 051     | 1601811-1†     | P051D20TCRS          |
| 20½-16<br>0.45-1.30     | .030-.051<br>0.76-1.29   | 900-2600     | .012<br>0.30      | .154<br>3.91       | Cu Ni                  | 061     | 1601818-1†     | P061D12A             |
| 20½-16<br>0.45-1.30     | .030-.051<br>0.76-1.29   | 900-2600     | .012<br>0.30      | .154<br>3.91       | Brass                  | 061     | 1601620-1†     | L061D12B             |
| 20½-16<br>0.45-1.30     | .030-.051<br>0.76-1.29   | 900-2600     | .012<br>0.30      | .154<br>3.91       | Tin Plated<br>Brass    | 061     | 1601514-1†     | G061D12TB            |
| 20½-16<br>0.45-1.30     | .030-.051<br>0.76-1.29   | 900-2600     | .016<br>0.41      | .154<br>3.91       | Cu Ni                  | 061     | 1601819-1      | P061D16A             |
| 20½-16<br>0.45-1.30     | .030-.051<br>0.76-1.29   | 900-2600     | .016<br>0.41      | .154<br>3.91       | Brass                  | 061     | 1601820-1      | P061D16B             |
| 20½-16<br>0.45-1.30     | .030-.051<br>0.76-1.29   | 900-2600     | .016<br>0.41      | .154<br>3.91       | Tin Plated<br>Brass    | 061     | 1601623-1      | L061D16TB            |
| 20½-16<br>0.45-1.30     | .030-.051<br>0.76-1.29   | 900-2600     | .018<br>0.46      | .154<br>3.91       | Brass                  | 061     | 1601625-1      | L061D18B             |
| 20½-16<br>0.45-1.30     | .030-.051<br>0.76-1.29   | 900-2600     | .018<br>0.46      | .154<br>3.91       | Tin Plated<br>Brass    | 061     | 1601628-1      | L061D18TB            |
| 20½-16<br>0.45-1.30     | .030-.051<br>0.76-1.29   | 900-2600     | .020<br>0.51      | .154<br>3.91       | Cu Ni                  | 061     | 1601629-1      | L061D20A             |
| 20½-16<br>0.45-1.30     | .030-.051<br>0.76-1.29   | 900-2600     | .020<br>0.51      | .154<br>3.91       | Brass                  | 061     | 1601630-1      | L061D20B             |
| 20½-16<br>0.45-1.30     | .030-.051<br>0.76-1.29   | 900-2600     | .020<br>0.51      | .154<br>3.91       | Tin Plated<br>Brass    | 061     | 1601631-1      | L061D20TBX           |
| 20-15<br>0.60-1.60      | .033-.057<br>0.84-1.45   | 1100-3200    | .016<br>0.41      | .154<br>3.91       | Brass                  | 061/076 | 1601601-1      | L061/076D16B         |
| 19½-14½<br>0.60-1.80    | .035-.061<br>0.89-1.54   | 1200-3700    | .016<br>0.41      | .154<br>3.91       | Brass                  | 061/092 | 1601603-1      | L061/092D16B         |
| 18-14<br>0.80-2.00      | .040-.063<br>1.02-1.60   | 1600-4000    | .012<br>0.30      | .154<br>3.91       | Cu Ni                  | 076     | 1601828-1      | P076D12A             |
| 18-14<br>0.80-2.00      | .040-.063<br>1.02-1.60   | 1600-4000    | .012<br>0.30      | .154<br>3.91       | Brass                  | 076     | 1601655-1†     | L076D12B             |
| 18-14<br>0.80-2.00      | .040-.063<br>1.02-1.60   | 1600-4000    | .016<br>0.41      | .154<br>3.91       | Cu Ni                  | 076     | 1601656-1      | L076D16A             |
| 18-14<br>0.80-2.00      | .040-.063<br>1.02-1.60   | 1600-4000    | .016<br>0.41      | .154<br>3.91       | Brass                  | 076     | 1601829-1      | P076D16B             |
| 18-14<br>0.80-2.00      | .040-.063<br>1.02-1.60   | 1600-4000    | .016<br>0.41      | .154<br>3.91       | Tin Plated<br>Brass    | 076     | 1601658-1      | L076D16TB            |
| 18-14<br>0.80-2.00      | .040-.063<br>1.02-1.60   | 1600-4000    | .018<br>0.46      | .154<br>3.91       | Cu Ni                  | 076     | 1601660-1      | L076D18AX            |
| 18-14<br>0.80-2.00      | .040-.063<br>1.02-1.60   | 1600-4000    | .018<br>0.46      | .154<br>3.91       | Brass                  | 076     | 1601661-1      | L076D18B             |
| 18-14<br>0.80-2.00      | .040-.063<br>1.02-1.60   | 1600-4000    | .018<br>0.46      | .154<br>3.91       | Tin Plated<br>Brass    | 076     | 1601664-1      | L076D18TB            |
| 18-14<br>0.80-2.00      | .040-.063<br>1.02-1.60   | 1600-4000    | .020<br>0.51      | .154<br>3.91       | Brass                  | 076     | 1601665-1      | L076D20B             |
| 18-14<br>0.80-2.00      | .040-.063<br>1.02-1.60   | 1600-4000    | .020<br>0.51      | .154<br>3.91       |                        | 076     | 1601667-1      | L076D20TCRS          |
| 18-14<br>0.80-2.00      | .040-.063<br>1.02-1.60   | 1600-4000    | .024<br>0.61      | .154<br>3.91       | Brass                  | 076     | 1601668-1      | L076D24B             |

† These part numbers are available upon special request; contact TE engineering for details.

**RTM Crimpband Splices** (Continued) This product line is not recommended for new designs, as the application machines are no longer manufactured.

**7 Ridges** (Continued)



| AWG/<br>mm <sup>2</sup> | Wire Range<br>Solid Dia. | CMA<br>Range | Stock<br>Thk. (T) | Mat'l<br>Width (W) | Material            | Toolset | Part<br>Number | Descriptive<br>X-ref |
|-------------------------|--------------------------|--------------|-------------------|--------------------|---------------------|---------|----------------|----------------------|
| 17½-13<br>0.95-2.54     | .042-.068<br>1.07-1.80   | 1800-4600    | .016<br>0.41      | .154<br>3.91       | Brass               | 076/092 | 1601642-1      | L076/<br>092D16BX    |
| 16½-13<br>1.10-2.60     | .047-.072<br>1.19-1.83   | 2200-5200    | .016<br>0.41      | .154<br>3.91       | Cu Ni               | 092     | 1601689-1      | L092D16ASP           |
| 16½-13<br>1.10-2.60     | .047-.072<br>1.19-1.83   | 2200-5200    | .016<br>0.41      | .154<br>3.91       | Brass               | 092     | 1601691-1      | L092D16B             |
| 16½-13<br>1.10-2.60     | .047-.072<br>1.19-1.83   | 2200-5200    | .016<br>0.41      | .154<br>3.91       | Tin Plated<br>Brass | 092     | 1601693-1      | L092D16TB            |
| 16½-13<br>1.10-2.60     | .047-.072<br>1.19-1.83   | 2200-5200    | .018<br>0.46      | .154<br>3.91       | Cu Ni               | 092     | 1601694-1      | L092D18A             |
| 16½-13<br>1.10-2.60     | .047-.072<br>1.19-1.83   | 2200-5200    | .018<br>0.46      | .154<br>3.91       | Brass               | 092     | 1601695-1      | L092D18B             |
| 16½-13<br>1.10-2.60     | .047-.072<br>1.19-1.83   | 2200-5200    | .018<br>0.46      | .154<br>3.91       | Tin Plated<br>Brass | 092     | 1601841-1      | P092D18TB            |
| 16½-13<br>1.10-2.60     | .047-.072<br>1.19-1.83   | 2200-5200    | .020<br>0.51      | .154<br>3.91       | Brass               | 092     | 1601528-1†     | G092D20B             |
| 16-12<br>1.30-3.46      | .051-.078<br>1.29-1.98   | 2600-6100    | .020<br>0.51      | .154<br>3.91       | Cu Ni               | 092/125 | 1601680-1      | L092/<br>125D20A     |
| 16-12<br>1.30-3.46      | .051-.078<br>1.29-1.98   | 2600-6100    | .020<br>0.51      | .154<br>3.91       | Brass               | 092/125 | 1601681-1      | L092/<br>125D20B     |
| 16-12<br>1.30-3.46      | .051-.078<br>1.29-1.98   | 2600-6100    | .020<br>0.51      | .154<br>3.91       | Tin Plated<br>CRS   | 092/125 | 1601682-1      | 092/<br>125D20TCRS   |
| 15½-12<br>1.54-3.46     | .055-.082<br>1.40-2.10   | 3000-6750    | .016<br>0.41      | .154<br>3.91       | Brass               | 125     | 1601529-1      | G125D16B             |
| 15½-12<br>1.54-3.46     | .055-.082<br>1.40-2.10   | 3000-6750    | .018<br>0.46      | .154<br>3.91       | Cu Ni               | 125     | 1601531-1      | G125D18A             |
| 15½-12<br>1.54-3.46     | .055-.082<br>1.40-2.10   | 3000-6750    | .018<br>0.46      | .154<br>3.91       | Brass               | 125     | 1601726-1      | L125D18B             |
| 15½-12<br>1.54-3.46     | .055-.082<br>1.40-2.10   | 3000-6750    | .018<br>0.46      | .154<br>3.91       | Tin Plated<br>Brass | 125     | 1601729-1      | L125D18TBX           |
| 15½-12<br>1.54-3.46     | .055-.082<br>1.40-2.10   | 3000-6750    | .020<br>0.51      | .154<br>3.91       | Brass               | 125     | 1601730-1      | L125D20B             |
| 15½-12<br>1.54-3.46     | .055-.082<br>1.40-2.10   | 3000-6750    | .020<br>0.51      | .154<br>3.91       | Tin Plated<br>Brass | 125     | 1601731-1      | L125D20TB            |
| 15½-12<br>1.54-3.46     | .055-.082<br>1.40-2.10   | 3000-6750    | .020<br>0.51      | .154<br>3.91       |                     | 125     | 1601733-1      | L125D20TCRS          |
| 14½-11½<br>1.80-4.00    | .059-.087<br>1.50-2.21   | 3500-7500    | .018<br>0.46      | .154<br>3.91       | Tin Plated<br>Brass | 125/165 | 1601709-1      | L125/<br>165D18TB    |
| 14½-11½<br>1.80-4.00    | .059-.087<br>1.50-2.21   | 3500-7500    | .020<br>0.51      | .154<br>3.91       | Cu Ni               | 125/165 | 1601710-1      | L125/<br>165D20A     |
| 14½-11½<br>1.80-4.00    | .059-.087<br>1.50-2.21   | 3500-7500    | .020<br>0.51      | .154<br>3.91       | Brass               | 125/165 | 1601711-1      | L125/<br>165D20B     |
| 14½-11½<br>1.80-4.00    | .059-.087<br>1.50-2.21   | 3500-7500    | .020<br>0.51      | .154<br>3.91       | Tin Plated<br>Brass | 125/165 | 1601712-1      | L125/<br>165D20TB    |
| 14-11<br>2.00-4.20      | .063-.092<br>1.60-2.34   | 4000-8500    | .020<br>0.51      | .154<br>3.91       | Cu Ni               | 165     | 1601754-1†     | L165D20A             |
| 14-11<br>2.00-4.20      | .063-.092<br>1.60-2.34   | 4000-8500    | .020<br>0.51      | .154<br>3.91       | Brass               | 165     | 1601755-1      | L165D20B             |
| 13½-10½<br>2.54-4.50    | .071-.097<br>1.70-2.46   | 4500-9500    | .020<br>0.51      | .154<br>3.91       | Brass               | 165/200 | 1601532-1      | G165/<br>200D20B     |
| 11½-9<br>4.00-6.50      | .084-.114<br>2.13-2.90   | 7000-13000   | .016<br>0.41      | .154<br>3.91       | Brass               | 200/202 | 1601764-1      | L200/<br>202D16B     |
| 11½-9<br>4.00-6.50      | .084-.114<br>2.13-2.90   | 7000-13000   | .020<br>0.51      | .154<br>3.91       | Cu Ni               | 200/202 | 1601765-1      | L200/<br>202D20A     |
| 11½-9<br>4.00-6.50      | .084-.114<br>2.13-2.90   | 7000-13000   | .020<br>0.51      | .154<br>3.91       | Brass               | 200/202 | 1601852-1      | P200/<br>202D20B     |
| 11½-9<br>4.00-6.50      | .084-.114<br>2.13-2.90   | 7000-13000   | .020<br>0.51      | .154<br>3.91       | Tin Plated<br>Brass | 200/202 | 1601766-1      | L200/<br>202D20TB    |

† These part numbers are available upon special request; contact TE engineering for details.

Crimband

**RTM Crimpband Splices** (Continued) This product line is not recommended for new designs, as the application machines are no longer manufactured.

**6 Ridges**



| AWG/<br>mm <sup>2</sup> | Wire Range<br>Solid Dia.      | CMA<br>Range | Stock<br>Thk. (T)   | Mat'l<br>Width (W)  | Material            | Toolset | Part<br>Number | Descriptive<br>X-ref |
|-------------------------|-------------------------------|--------------|---------------------|---------------------|---------------------|---------|----------------|----------------------|
| 24-20<br>0.20-0.50      | <b>.020-.033</b><br>0.51-0.84 | 400-1100     | <b>.012</b><br>0.30 | <b>.138</b><br>3.51 | Tin Plated<br>Brass | 032/036 | 1601548-1      | L032/<br>036C12TB    |
| 24-20<br>0.20-0.50      | <b>.020-.033</b><br>0.51-0.84 | 400-1100     | <b>.016</b><br>0.41 | <b>.138</b><br>3.51 | Brass               | 032/036 | 1601549-1      | L032/<br>036C16B     |
| 22-19<br>0.38-0.60      | <b>.024-.036</b><br>0.61-0.91 | 600-1300     | <b>.012</b><br>0.30 | <b>.138</b><br>3.51 | Brass               | 045     | 1601566-1      | L045C12B             |
| 22-19<br>0.38-0.60      | <b>.024-.036</b><br>0.61-0.91 | 600-1300     | <b>.016</b><br>0.41 | <b>.138</b><br>3.51 | Cu Ni               | 045     | 1601569-1      | L045C16A             |
| 22-19<br>0.38-0.60      | <b>.024-.036</b><br>0.61-0.91 | 600-1300     | <b>.016</b><br>0.41 | <b>.138</b><br>3.51 | Brass               | 045     | 1601571-1      | L045C16B             |
| 21-18½<br>0.40-0.75     | <b>.028-.039</b><br>0.71-0.99 | 800-1500     | <b>.012</b><br>0.30 | <b>.138</b><br>3.51 | Brass               | 051     | 1601808-1†     | P051C12B             |
| 21-18½<br>0.40-0.75     | <b>.028-.039</b><br>0.71-0.99 | 800-1500     | <b>.016</b><br>0.41 | <b>.138</b><br>3.51 | Cu Ni               | 051     | 1601809-1      | P051C16A             |
| 21-18½<br>0.40-0.75     | <b>.028-.039</b><br>0.71-0.99 | 800-1500     | <b>.016</b><br>0.41 | <b>.138</b><br>3.51 | Brass               | 051     | 1601810-1      | P051C16B             |
| 21-18½<br>0.40-0.75     | <b>.028-.039</b><br>0.71-0.99 | 800-1500     | <b>.018</b><br>0.46 | <b>.138</b><br>3.51 | Brass               | 051     | 1601586-1†     | L051C18B             |
| 20½-16<br>0.45-1.30     | <b>.030-.051</b><br>0.76-1.29 | 900-2600     | <b>.016</b><br>0.41 | <b>.138</b><br>3.51 | Cu Ni               | 061     | 1601614-1      | L061C16A             |
| 20½-16<br>0.45-1.30     | <b>.030-.051</b><br>0.76-1.29 | 900-2600     | <b>.016</b><br>0.41 | <b>.138</b><br>3.51 | Brass               | 061     | 1601511-1      | G061C16B             |
| 20½-16<br>0.45-1.30     | <b>.030-.051</b><br>0.76-1.29 | 900-2600     | <b>.016</b><br>0.41 | <b>.138</b><br>3.51 | Tin Plated<br>Brass | 061     | 1601617-1      | L061C16TB            |
| 20½-16<br>0.45-1.30     | <b>.030-.051</b><br>0.76-1.29 | 900-2600     | <b>.018</b><br>0.46 | <b>.138</b><br>3.51 | Cu Ni               | 061     | 1601618-1      | L061C18AX            |
| 20½-16<br>0.45-1.30     | <b>.030-.051</b><br>0.76-1.29 | 900-2600     | <b>.018</b><br>0.46 | <b>.138</b><br>3.51 | Brass               | 061     | 1601619-1      | L061C18B             |
| 20½-16<br>0.45-1.30     | <b>.030-.051</b><br>0.76-1.29 | 900-2600     | <b>.020</b><br>0.51 | <b>.138</b><br>3.51 | Brass               | 061     | 1601513-1†     | G061C20B             |
| 20-15<br>0.60-1.60      | <b>.033-.057</b><br>0.84-1.45 | 1100-3200    | <b>.016</b><br>0.41 | <b>.138</b><br>3.51 | Brass               | 061/076 | 1601597-1      | L061/<br>076C16B     |
| 20-15<br>0.60-1.60      | <b>.033-.057</b><br>0.84-1.45 | 1100-3200    | <b>.016</b><br>0.41 | <b>.138</b><br>3.51 | Tin Plated<br>Brass | 061/076 | 1601599-1      | L061/<br>076C16TB    |
| 20-15<br>0.60-1.60      | <b>.033-.057</b><br>0.84-1.45 | 1100-3200    | <b>.018</b><br>0.46 | <b>.138</b><br>3.51 | Brass               | 061/076 | 1601600-1†     | L061/<br>076C18B     |
| 18-14<br>0.80-2.00      | <b>.040-.063</b><br>1.02-1.60 | 1600-4000    | <b>.016</b><br>0.41 | <b>.138</b><br>3.51 | Cu Ni               | 076     | 1601650-1      | L076C16A             |
| 18-14<br>0.80-2.00      | <b>.040-.063</b><br>1.02-1.60 | 1600-4000    | <b>.016</b><br>0.41 | <b>.138</b><br>3.51 | Brass               | 076     | 1601651-1      | L076C16B             |
| 18-14<br>0.80-2.00      | <b>.040-.063</b><br>1.02-1.60 | 1600-4000    | <b>.018</b><br>0.46 | <b>.138</b><br>3.51 | Cu Ni               | 076     | 1601652-1†     | L076C18A             |
| 18-14<br>0.80-2.00      | <b>.040-.063</b><br>1.02-1.60 | 1600-4000    | <b>.018</b><br>0.46 | <b>.138</b><br>3.51 | Brass               | 076     | 1601827-1      | P076C18B             |
| 18-14<br>0.80-2.00      | <b>.040-.063</b><br>1.02-1.60 | 1600-4000    | <b>.018</b><br>0.46 | <b>.138</b><br>3.51 |                     | 076     | 1601654-1†     | L076C18TCRS          |
| 17½-13<br>0.95-2.54     | <b>.042-.068</b><br>1.07-1.80 | 1800-4600    | <b>.016</b><br>0.41 | <b>.138</b><br>3.51 | Brass               | 076/092 | 1601640-1      | L076/<br>092C16B     |
| 16½-13<br>1.10-2.60     | <b>.047-.072</b><br>1.19-1.83 | 2200-5200    | <b>.016</b><br>0.41 | <b>.138</b><br>3.51 | Cu Ni               | 092     | 1601837-1      | P092C16AX            |
| 16½-13<br>1.10-2.60     | <b>.047-.072</b><br>1.19-1.83 | 2200-5200    | <b>.016</b><br>0.41 | <b>.138</b><br>3.51 | Brass               | 092     | 1601687-1      | L092C16B             |
| 15½-12<br>1.54-3.46     | <b>.055-.082</b><br>1.40-2.10 | 3000-6750    | <b>.016</b><br>0.41 | <b>.138</b><br>3.51 | Tin Plated<br>Brass | 125     | 1601721-1      | L125C16TB            |
| 15½-12<br>1.54-3.46     | <b>.055-.082</b><br>1.40-2.10 | 3000-6750    | <b>.018</b><br>0.46 | <b>.138</b><br>3.51 | Cu Ni               | 125     | 1601722-1      | L125C18A             |
| 15½-12<br>1.54-3.46     | <b>.055-.082</b><br>1.40-2.10 | 3000-6750    | <b>.018</b><br>0.46 | <b>.138</b><br>3.51 | Brass               | 125     | 1601723-1      | L125C18B             |

† These part numbers are available upon special request; contact TE engineering for details.

**RTM Crimpband Splices** (Continued) This product line is not recommended for new designs, as the application machines are no longer manufactured.

**3 Ridges**



| AWG/<br>mm <sup>2</sup> | Wire Range<br>Solid Dia. | CMA<br>Range | Stock<br>Thk. (T) | Mat'l<br>Width (W) | Material            | Toolset | Part<br>Number | Descriptive<br>X-ref |
|-------------------------|--------------------------|--------------|-------------------|--------------------|---------------------|---------|----------------|----------------------|
| 27½-21<br>0.09-0.40     | .013-.028<br>0.33-0.71   | 170-800      | .012<br>0.30      | .076<br>1.93       | Brass               | 032     | 1601555-1      | L032B12B             |
| 24-20<br>0.20-0.50      | .020-.033<br>0.51-0.84   | 400-1100     | .012<br>0.30      | .076<br>1.93       | Cu Ni               | 032/036 | 1601542-1      | L032/<br>036B12A     |
| 24-20<br>0.20-0.50      | .020-.033<br>0.51-0.84   | 400-1100     | .012<br>0.30      | .076<br>1.93       | Brass               | 032/036 | 1601795-1      | P032/<br>036B12B     |
| 24-20<br>0.20-0.50      | .020-.033<br>0.51-0.84   | 400-1100     | .016<br>0.41      | .076<br>1.93       | Brass               | 032/036 | 1601545-1      | L032/<br>036B16B     |
| 24-20<br>0.20-0.50      | .020-.033<br>0.51-0.84   | 400-1100     | .016<br>0.41      | .076<br>1.93       | Tin Plated<br>Brass | 032/036 | 1601546-1      | L032/<br>036B16TB    |
| 24-20<br>0.20-0.50      | .020-.033<br>0.51-0.84   | 400-1100     | .018<br>0.46      | .076<br>1.93       | Brass               | 032/036 | 1601547-1†     | L032/<br>036B18B     |
| 22-19<br>0.38-0.60      | .024-.036<br>0.61-0.91   | 600-1300     | .016<br>0.41      | .076<br>1.93       | Cu Ni               | 045     | 1601503-1      | G045B16A             |
| 22-19<br>0.38-0.60      | .024-.036<br>0.61-0.91   | 600-1300     | .016<br>0.41      | .076<br>1.93       | Brass               | 045     | 1601562-1      | L045B16B             |
| 22-19<br>0.38-0.60      | .024-.036<br>0.61-0.91   | 600-1300     | .016<br>0.41      | .076<br>1.93       | Tin Plated<br>Brass | 045     | 1601504-1†     | G045B16TB            |
| 22-19<br>0.38-0.60      | .024-.036<br>0.61-0.91   | 600-1300     | .016<br>0.41      | .076<br>1.93       | Tin Plated<br>Brass | 045     | 1601564-1      | L045B16TBSP          |
| 21-18½<br>0.40-0.75     | .028-.039<br>0.71-0.99   | 800-1500     | .016<br>0.41      | .076<br>1.93       | Cu Ni               | 051     | 1601580-1†     | L051B16A             |
| 21-18½<br>0.40-0.75     | .028-.039<br>0.71-0.99   | 800-1500     | .016<br>0.41      | .076<br>1.93       | Brass               | 051     | 1601582-1†     | L051B16B             |
| 21-18½<br>0.40-0.75     | .028-.039<br>0.71-0.99   | 800-1500     | .016<br>0.41      | .076<br>1.93       | Tin Plated<br>Brass | 045     | 1601583-1†     | L051B16TB            |
| 21-18½<br>0.40-0.75     | .028-.039<br>0.71-0.99   | 800-1500     | .020<br>0.51      | .076<br>1.93       | Brass               | 051     | 1601584-1      | L051B20B             |
| 20½-16<br>0.45-1.30     | .030-.051<br>0.76-1.29   | 900-2600     | .016<br>0.41      | .076<br>1.93       | Tin Plated<br>Brass | 061     | 1601612-1†     | L061B16TB            |
| 20½-16<br>0.45-1.30     | .030-.051<br>0.76-1.29   | 900-2600     | .016<br>0.41      | .076<br>1.93       | Cu Ni               | 061     | 1601610-1      | L061B16A             |
| 20½-16<br>0.45-1.30     | .030-.051<br>0.76-1.29   | 900-2600     | .016<br>0.41      | .076<br>1.93       | Brass               | 061     | 1601611-1      | L061B16B             |
| 20½-16<br>0.45-1.30     | .030-.051<br>0.76-1.29   | 900-2600     | .016<br>0.41      | .076<br>1.93       | Brass               | 061     | 1601635-1      | L061L16B             |
| 20-15<br>0.60-1.60      | .033-.057<br>0.84-1.45   | 1100-3200    | .016<br>0.41      | .076<br>1.93       | Tin Plated<br>Brass | 061/076 | 1601596-1      | L061/<br>076B16TBX   |
| 18-14<br>0.80-2.00      | .040-.063<br>1.02-1.60   | 1600-4000    | .016<br>0.41      | .076<br>1.93       | Brass               | 076     | 1601825-1      | P076B16B             |
| 18-14<br>0.80-2.00      | .040-.063<br>1.02-1.60   | 1600-4000    | .020<br>0.51      | .076<br>1.93       | Brass               | 076     | 1601649-1      | L076B20B             |

† These part numbers are available upon special request; contact TE engineering for details.

Crimband

## Power Splice

### Product Facts

- Compression crimp eliminates cold solder points, weld burns and wire embrittlement usually connected with thermal-type terminations
- Precisely controlled crimp termination helps eliminate human error, for maximum reliability
- Excellent tensile strength, up to 90 lbs axial retention, vibration resistant
- Provides a superior electrical connection that is free of many contaminants such as stripper residue and solder flux
- 8000 - 38,000 CMA nominal capacity
- Accepts up to six magnet wires and two standard solid or stranded lead wires
- Superior test results: low resistance, high stability
- High termination rates, low wire consumption and the elimination of rejects caused by solder flux or heat damage results in the lowest applied costs

### Applications

- Hermetic/Compressor motors
- Squirrel cage DC motors
- Capacitor start motors
- Gear & Traction motors
- Power supplies
- Liner, Torroid & RF transformers
- Circuit breakers & welders



TE features the Power Splice terminal that is specifically designed to terminate a wide range of lead and magnet wire combinations.

The splice contains two cavities that separate and cradle magnet wire and stripped lead wires prior to crimping.

The outer saddle accepts up to six-magnet wire allowing for a CMA range of 15,000 to 30,000.

The inner saddle accepts pre-stripped lead wires that total up to 10,900 CMA.



In a one step automatic operation, the magnet wire film insulation is multiple ring-stripped as it is forced into the serrations while the lead wire is simultaneously terminated during the precisely controlled crimp.

The outer saddle has machined, sharp edges made by a special production process that pierces the insulating layer of the magnet wire in a manner that provides a large contact area.

The resulting termination produces a high tensile strength, air sealed connection that is as resistant to corrosion as the insulated conductor with up to 90 lbs axial retention.

As many as six magnet wires can be terminated simultaneously in one splice in combination with up to two pre-stripped standard solid or stranded lead wire.

A semi-automatic machine provides high output per hour terminations.



**Power Splice** (Continued)



| Type | Magnet Wire Range<br>CMA | Lead Wire Range<br>CMA | Part Number<br>Reeled  |
|------|--------------------------|------------------------|------------------------|
| A    | 15,000-30,000            | 4200-10,900            | 1601953-1 <sup>1</sup> |

<sup>1</sup> Total combined CMA not to exceed 38000.



Part Number 111-000-001

Power Splice

## Application Tooling

### Worldwide Leadership in Wire and PCB Manufacturing Products

Leadership demands commitment and TE is committed to meeting manufacturing needs worldwide with technology, products and systems, and service.

#### Application Tooling of TE Connectivity

TE has long been recognized as a leader in providing the tools for wire harness and printed circuit manufacturing. There's a good reason. Our products are designed to meet and anticipate our customers' ever-changing requirements and built to the highest quality standards, for longest, most productive performance lifetimes.

Whatever your production volume and job mix, we can offer the tools to get it done. With a full range of tooling from hand tools to high volume, fully automated systems, TE is able to meet most manufacturing demands worldwide. It's an ability that comes from our experience with manufacturers large and small, giving us a unique view of the trends and challenges in wire harness and PCB manufacturing. It all derives from our commitment to your manufacturing challenges, giving you the advantage in your marketplace.

This catalog is just a sampling of the types of solutions that will make your job easier, faster, more productive and more profitable. Make tooling, assembly equipment, and service from TE part of your thinking, now and as you grow into the future.

#### TE Connectivity Service and Support

Few suppliers can match TE customer service and support. From helping you select the tooling for your requirements to maintenance and repair and analyzing your operation for maximum productivity, our worldwide capabilities and experience will make a real difference in your production and bottom line.

**ProductionChek Service** — In a consultative role, our field engineer will meet with you to determine your objectives and known production issues, then observe and record in detail each step in your operation. Based on this information, the engineer will be able to make recommendations for improvement, typically in people, process or equipment.

**Tool Repair and Certification** — Our field engineers will set up, certify, and repair application tooling on site or recommend our factory-level service. Flexible plans, including options for premium access to parts and service, will keep your PCB assembly automation equipment running at peak performance.

For additional maintenance services, the TE Technical Support Center is dedicated to providing the answers you need, toll-free at 1-800-522-6752. Support contracts are available for preventive maintenance, training, emergency situations and other specific requirements.

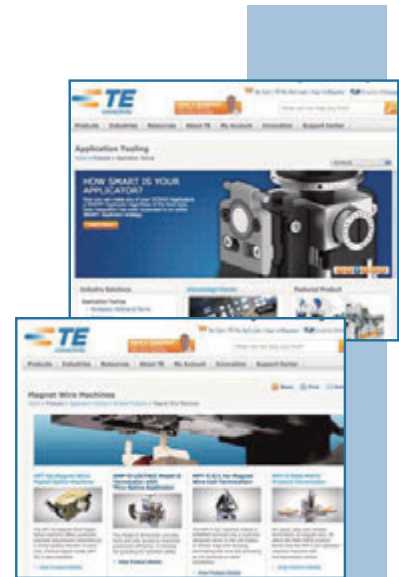

*For more information regarding the products and services shown in this brochure, visit our website at [www.tooling.te.com](http://www.tooling.te.com)*

## Application Tooling

### Magnet Wire Crimp Application Equipment

MAG-MATE and AMPLIVAR splices and terminals are available in a wide range of configurations to meet most magnet-wire termination needs. All provide high reliability with minimal wire preparation. TE Connectivity offers a wide variety of magnet-wire termination solutions for thru splicing, pigtail splicing and coil termination.

#### AMPLIVAR Product Terminator (APT) Machines

The new APT 5A magnet wire pigtail splice machine offers a fast, efficient system, with no need to strip mag-wire insulation. Simply place the wires in the target area and depress the foot switch. The machine automatically shears the splice or Direct Connect contact from the strip, crimps it, shears off excess wire, and advances the next splice or contact into position.

APT bench machines are available in two versions: the 5A with automatic precision adjustment controlled by the crimp quality monitor (CQM) and the 5E with manual precision adjustment. Using CQM, the APT 5A provides 100% inspection and automatic adjustment of crimp height. If a questionable crimp is detected, visual and audible alarms alert the operator.

The lower cost, manual adjust APT 5E is a simpler version with the advantage of faster set-up times but without CQM capability.

#### Power Splice Machine

*Not CE approved, contact engineering for quotation.*

The Power Splice Machine and applicator from TE provides reliable pigtail splice termination of magnet wire and solid or stranded lead wire. This machine can terminate pigtail splices consisting of up to two solid or stranded copper lead wires in wire size from 10-14 AWG and having a Circular Mil Area (CMA) of 4,100 - 11,000. The splice will simultaneously accept combinations of multiple copper magnet wires in a range of 11-20 AWG. The total CMA range for lead wire and magnet wire is 4,000 to 40,000.

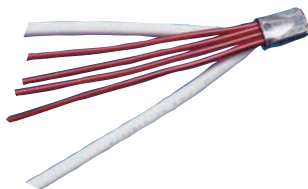

## Application Tooling

### Magnet Wire Crimp Application Equipment

#### **AMPLIVAR Terminator for Parallel and End Connections**

*Primarily sold in Europe.*

The machine was developed for processing magnet wire connections. Different versions for end-feed and side-feed contacts are available. The design takes into account that the motor windings and coils can be supplied directly to the connectors. The exposed crimp position permits precise handling. In case of end connections the projecting magnet wires are cut off.

AMPLIVAR splices and terminals are specifically designed to terminate magnet wires or in combination with standard solid or stranded wire. In a one-step operation the magnet wire is automatically multiple ring stripped of its insulation as it is forced into the serrations during the precisely controlled crimping operation.

As many as three magnet wires can be terminated, simultaneously in one splice. Nearly the entire AMPLIVAR splice program can be applied with this machine in combination with suitable applicators. The comprehensive range of manufacturing possibilities demands a specific machine and applicator combination.

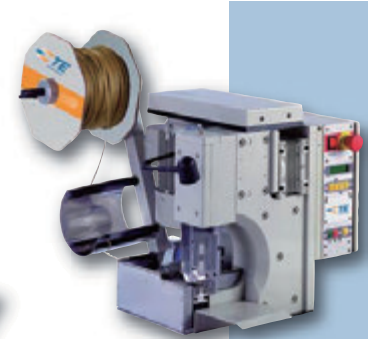

#### **AMP-O-LECTRIC Model G Terminator with Thru-Splice Applicator**

*Not CE Approved.*

Applying thru-splices is fast and efficient when you have access to both sides of the applicator for placing and holding the wires. The AMP-O-LECTRIC model G splice terminator with a standard G splice applicator provides front and rear access to maximize production efficiency. It provides full guarding for operator safety and is available with or without a Crimp Quality Monitor. **Request catalog 889021 for more information.**

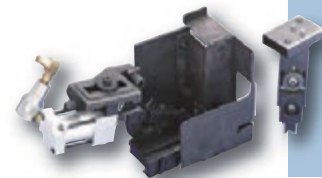

## Application Tooling

### Magnet Wire Crimp Application Equipment

**Crimband application machines have been discontinued and are no longer offered by TE.**

#### Crimband Application Tooling

*Not CE approved, contact engineering for quotation.*

TE offers solderless crimping systems to handle a wide range of wire connections including solid and stranded lead wire, insulated magnet wire, and component leads. Each system is comprised of continuous, serrated Crimband material and a crimping machine. The TE solution allows the flexibility to create a shape and size, which optimizes the crimp's electrical and mechanical performance.

The TE crimping system produces a very economical and reliable interconnection. Utilizing a continuous crimpband material the machine will feed, cut form, and crimp your application resulting in a very strong and uniform interconnect crimp.

Whether your application required a wire-to-wire, wire to components leads, wire to terminals, or magnet wire splice termination, the very flexible and dependable crimping machine will provide high-speed scrap free interconnects.

Substantial increase in production interconnection rates can be realized versus traditional soldering. Not to mention it completely eliminates the noxious fumes.

The **mod I crimping system** is used when running standard RTM and MTM crimpband product. In addition, left and right horn termination machines are available when your application requires additional working envelope.

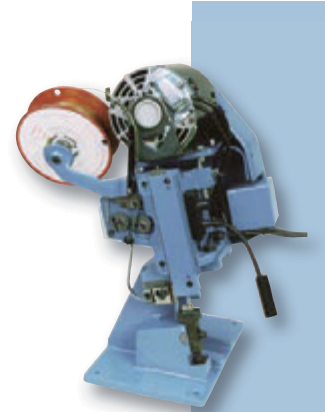
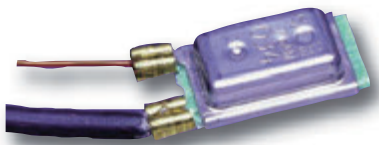

**Application Tooling**

**Magnet Wire MAG-MATE Terminal Application Equipment**

**MPT-5 MAG-MATE Product Terminator**

*Not CE approved, refer to Mark I, Mark II pages 83, 84.*

The MPT-5 is an air-operated machine with microprocessor control that inserts MAG-MATE terminals into customer-designed cavities in the coil bobbin or similar magnet-wire housing, terminating the wire for connectivity. *Please note: The customer designed cavities must follow TE specification guidelines.* Termination of single, dual, triple and up to quadruple termination possible depending on the application details. The machine is available in either vertical or horizontal configuration to match the customer's application.

The dual reel capability of the MPT-5 machine allows insertion of two different MAG-MATE terminals, with the capability to alternate between inserting one and two terminals at a time. The MPT-5 is also capable of trimming excess magnet wire.

The MPT-5 Terminator also has the capability to alternate between inserting 2 bridged (or commoned) terminals and 2 separated terminals.

**Request catalog 1308387 for more information.**

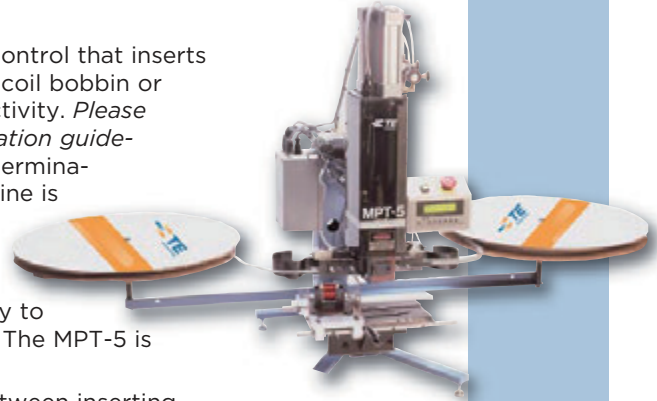

**MAG-MATE Terminal Cavity and Fixture Design**

MAG-MATE terminals insert into a molded-in cavity in the coil bobbin. The bobbin is generally secured in a fixture during the insertion/termination process. TE engineers work with our customers to support cavity and fixture design, at any level. We can provide complete design of cavities and fixtures for customer's applications, work with our customer's engineers, or simply provide CAD models and other engineering data as needed. Consultation early in the design process allows customers maximum benefit from our decades of magnet-wire experience.

**Product Line Integration**

The MPT-5 and APT IIIA Machines have the production capacity and the electronics for easy integration into automated production lines. TE Engineers work with your system integrators to assure the efficiency of TE equipment into the line's design and assembly.





**Application Tooling**

**Magnet Wire MAG-MATE Terminal Application Equipment**

**MPT-5 S/L Machine** (for SIAMEZE and Lead Lok Terminals)

*Not CE approved, refer to Mark I, Mark II pages 83, 84.*

For quick, easy and reliable termination of magnet wire, TE offers the MPT-5 S/L MAG-MATE product terminator — an air-operated insertion machine with microprocessor control.

The MPT-5 S/L machine inserts a SIAMEZE terminal into a customer-designed cavity in the coil bobbin or similar mag-wire housing, terminating the wire for connectivity. Please note: The customer designed cavities must follow TE specification guidelines. It can insert both the SIAMEZE terminal and the Lead Lok terminal to assure your lead wire connection. The MPT-5 S/L offers dual reel capability and is also capable of trimming excess magnet wire. The dual reel capability of the MPT-5 S/L allows insertion of two different SIAMEZE terminals, with the capability to alternate between inserting one and two terminals at a time.

The MPT-5 S/L machine is available as a horizontal or vertical bench machine or as a discrete module for integration into automated lines.

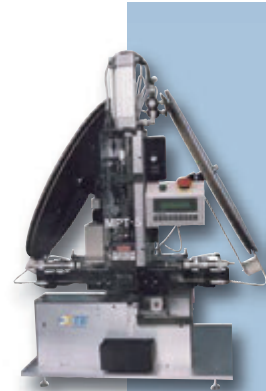

**MPT-5 S/L**



**EMT — Entry Level Magnet Wire Terminator**

(for loose piece SIAMEZE, Lead Lok, or MAG-MATE Terminals)

*Not CE approved, contact engineering for quotation.*

The Entry Level Magnet Wire Terminator tube design is based on the proven MPT-5 system and incorporates a fine adjust mechanism for easy set-up. The floating tube bottoms on the top of the terminal cavity to create the datum for the insertion depth of the terminal. The insertion depth can be adjusted in .002" [.05 mm] increments quickly and easily.

An unobstructed view of the tube bottom permits the operator to easily load loose piece terminals. A two-handed actuation system protects the operators during the insertion process and the open architecture design allows operators to easily load and unload the stators on and off the fixture.



**Entry Level Terminator**

**Application Tooling**

**Magnet Wire MAG-MATE Terminal Application Equipment**

**Manual Hand Tool**

(for loose piece SIAMEZE, Lead Lok, or MAG-MATE Terminals)

- Inserts loose piece terminals into molded cavities
- Insertion depth is repeatable due to the hand tools design which requires the operator to fully compress the handle before it is allowed to retract
- Since tooling captures the cavities during insertion, no fixturing is needed
- Hand tools are available quickly for prototyping, repair, and/or low volume applications

*\*\* The manual hand tool is not compatible with every application. Please contact TE Connectivity for more information.*



**Manual Hand Tool**

**Manual Arbor Press**

(for loose piece SIAMEZE, Lead Lok, or MAG-MATE Terminals)

- Inserts loose piece terminals into molded cavities
- One tip is capable of inserting the SIAMEZE wire-to-wire terminal, the lead wire and the Lead Lok terminal
- Insertion tip bottoms on the top of the cavity to provide repeatable insertion depth capability
- Customers often supply their own fixtures for prototyping or low volume requirements
- Tips, arbor presses, and CERTI-LOK hand tools are available quickly for prototyping applications requirements



**Manual Arbor Press**

**Hand Insertion Tools**

- Inserts loose piece terminals into molded cavities
- Available quickly for prototyping application requirements
- Available for each type of MAG-MATE terminal

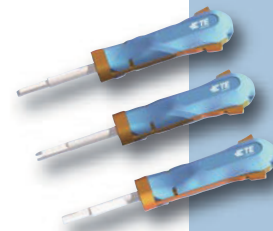

**Insertion Tools**

**Full Line of Crimp Tooling**

- TE offers a full line of hand tools, bench equipment, and automatic machines to perform the wire crimps for the mating end of these MAG-MATE connections.

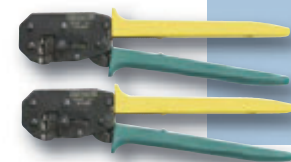

**CERTI-LOK Tools**

**Application Tooling**

**Magnet Wire MAG-MATE Terminal Application Equipment**

**MAG-MATE Inserter MK I with Pneumatic Control,**  
*Primarily sold in Europe.*

- Single, dual, triple and quadruple insertion
- Module easily integrated into production lines using simple handshake signals
- Holding fixture for bobbin can be designed and built by TE
- Can apply standard MAG-MATE and SIAMEZE terminals
- Load-while-running feature increases productivity
- Cycle time: 0.9 - 1.3 s depending on terminal type
- Mechanical insertion force limiter optional



**MK I Inserter**

**MAG-MATE Inserter MK I with Electro Pneumatic Control (PLC),**  
*Primarily sold in Europe.*

- Single contact
- Double contacts with or without bridge
- 2 single contacts alternately with 2 bridged contacts
- Module is easily integrated into customer's production line using simple handshake signals
- Terminations up to 4 terminals at a time as single or linked type
- Mechanical insertion force limiter optional



**Mark II Inserter with PLC**

**MAG-MATE and SIAMEZE Inserter Mark II with PLC,**  
*Primarily sold in Europe.*

TE magnet wire terminations are a perfect connecting alternative to all soldering techniques used in a lead-free environment. Special knowledge is required to design a mass manufacturing line for insulation displacement crimps on thin lacquered insulated wires with high yield. Design aspects of the terminal, the cavity and the machine all need to be harmonized. With the Inserter Mark II, TE can offer an economic solution especially for the application of MAG-MATE and SIAMEZE terminals.

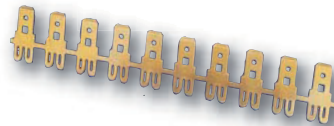

**Application Tooling**

**Magnet Wire MAG-MATE Terminal Application Equipment**

**MAG-MATE and SIAMEZE Inserter Mark II with PLC and Insertion Force Control,**  
*Primarily sold in Europe.*

This advanced insertion machine provides the features of the MAG-MATE inserter Mark II with an additional force distance control system. The machine is designed to apply multiple different contacts and will be customized according to the customer or product specific requirement. The contacts can be used as single contacts or in strip form (bridge function adjusted "on-the-fly").

A gauge is available to check the adjusted insertion force and to recalibrate the insertion force control sensor.

**Request catalog 7-1773440-4 for more information.**

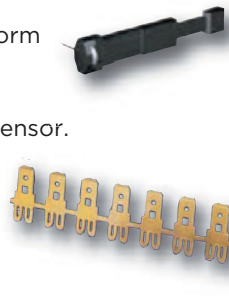

**Mark II Inserter with PLC and Insertion Force Control**

**Pneumatic Insertion Tool for MAG-MATE Terminals,**  
*Primarily sold in Europe.*

The pneumatic tool for MAG-MATE terminals features a rotary insertion finger to facilitate different insertion angles.

This tool is designed for use in TE standard insertion machines such as P200 and P300 but can also be integrated into customized production lines or assembly cells.

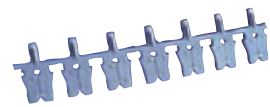

**Pneumatic Insertion Tool**

**Application Tooling**

**Magnet Wire MAG-MATE Terminal Application Equipment**

**Customer Specific Machines**

This unique machine was developed to process all IDC terminals regardless of shape and configuration. The insertion head module is capable of inserting individual or multiple terminals and can be configured for dual feed, left and right hand supply reels.

The servo-driven NC-Axis facilitates precisely controlled insertion with programmable ramp profile. If required, a servo driven torque motor will locate the stator/bobbin to programmable positions.

Excess magnet wire and wrap post are cut-off during the insertion cycle and removed via a ventury. The cutting punches are cam actuated via our patented linear slide module.

The machine is designed and built for easy maintenance. Spare parts (punches, insertion blades, trim blades, die plate inset) are easy to access and replace.



**Custom Built IDC Terminal Insertion Head**

The insertion head module is designed to be integrated into a rotary index or linear transfer line. The IDC terminal insertion can be in vertical or horizontal plane. The terminal strip feeds from the right and/or from the left, if necessary with 2 different terminal configurations.

Wrap posts and excess magnet wire can be removed via a trim blade. Insertion force monitoring is available as an option.

The insertion head module is custom built according to your requirements.

**Request catalog 7-1773440-4 for more information.**

**Cam driven linear slide module for punch actuation.**

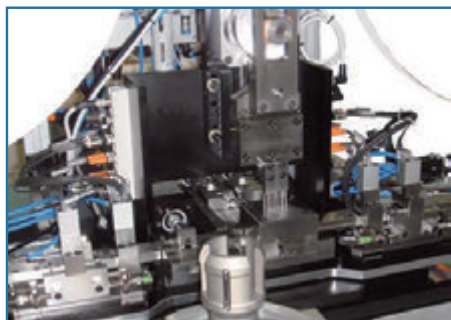

**Horizontal Design**



**Vertical Design**

**Technical Information**

**Tensile Strength of Magnet Wire<sup>1</sup>**

| Wire Size | Nominal Dia. Copper (lbs.) | Nominal Dia. Aluminum (lbs.) |
|-----------|----------------------------|------------------------------|
| 8         | 438                        | 142                          |
| 9         | 340                        | 113                          |
| 10        | 269                        | 89                           |
| 11        | 213                        | 71                           |
| 12        | 189                        | 56                           |
| 13        | 134                        | 44                           |
| 14        | 106                        | 35                           |
| 15        | 84                         | 28                           |
| 16        | 66                         | 22                           |
| 17        | 53                         | 17                           |
| 18        | 42                         | 14                           |
| 19        | 33                         | 11                           |
| 20        | 6                          | 8                            |
| 21        | 21                         | 7                            |
| 22        | 16                         | 5                            |
| 23        | 13                         | 4                            |
| 24        | 10                         | 3                            |
| 25        | 8                          | 2.7                          |
| 26        | 6                          | 2.1                          |
| 27        | 5                          | 1.7                          |
| 28        | 4                          | 1.3                          |
| 29        | 3                          | 1.1                          |
| 30        | 2                          | .86                          |
| 31        | 2                          | .68                          |
| 32        | 1                          | .55                          |
| 33        | 1                          | .43                          |
| 34        | 1                          | .34                          |
| 35        | .81                        | .27                          |
| 36        | .65                        | .21                          |
| 37        | .65                        | .21                          |
| 38        | .42                        | .13                          |
| 39        | .32                        | .10                          |
| 40        | .25                        | .083                         |
| 41        | .20                        | .067                         |
| 42        | .16                        | .054                         |
| 43        | .12                        | .041                         |
| 44        | .10                        | .034                         |
| 45        | .08                        | .027                         |
| 46        | .06                        | .022                         |
| 47        | .05                        | .017                         |
| 48        | .04                        | .013                         |
| 49        | .03                        | .010                         |
| 50        | .02                        | .009                         |
| 51        | .02                        | .007                         |
| 52        | .01                        | .005                         |

| C.  | F.     | C. | F.    | C. | F.    | C.   | F.     |
|-----|--------|----|-------|----|-------|------|--------|
| -80 | -112.0 | 9  | 48.2  | 47 | 116.6 | 85   | 185.0  |
| -70 | -94.0  | 10 | 50.0  | 48 | 118.4 | 86   | 186.8  |
| -60 | -76.0  | 11 | 51.8  | 49 | 120.2 | 87   | 188.6  |
| -50 | -58.0  | 12 | 53.6  | 50 | 122.0 | 88   | 190.4  |
| -45 | -49.1  | 13 | 55.4  | 51 | 123.8 | 89   | 192.2  |
| -40 | -40.0  | 14 | 57.2  | 52 | 125.6 | 90   | 194.0  |
| -35 | -31.0  | 15 | 59.0  | 53 | 127.4 | 91   | 195.8  |
| -30 | -22.0  | 16 | 60.8  | 54 | 129.2 | 92   | 197.6  |
| -25 | -13.0  | 17 | 62.6  | 55 | 131.0 | 93   | 199.4  |
| -20 | - 4.0  | 18 | 64.4  | 56 | 132.8 | 94   | 201.2  |
| -19 | - 2.2  | 19 | 66.2  | 57 | 134.6 | 95   | 203.0  |
| -18 | - .4   | 20 | 68.0  | 58 | 136.4 | 96   | 204.8  |
| -17 | 1.4    | 21 | 69.8  | 59 | 138.2 | 97   | 206.6  |
| -16 | 3.2    | 22 | 71.6  | 60 | 140.0 | 98   | 208.4  |
| -15 | 5.0    | 23 | 73.4  | 61 | 141.8 | 99   | 210.2  |
| -14 | 6.8    | 24 | 75.2  | 62 | 143.6 | 100  | 212.0  |
| -13 | 8.6    | 25 | 77.0  | 63 | 145.4 | 110  | 230.0  |
| -12 | 10.4   | 26 | 78.8  | 64 | 147.2 | 120  | 248.0  |
| -11 | 12.2   | 27 | 80.6  | 65 | 149.0 | 130  | 266.0  |
| -10 | 14.0   | 28 | 82.4  | 66 | 150.8 | 140  | 284.0  |
| - 9 | 15.8   | 29 | 84.2  | 67 | 152.6 | 150  | 302.0  |
| - 8 | 17.6   | 30 | 86.0  | 68 | 154.4 | 160  | 320.0  |
| - 7 | 19.4   | 31 | 87.8  | 69 | 156.2 | 170  | 338.0  |
| - 6 | 21.2   | 32 | 89.6  | 70 | 158.0 | 180  | 356.0  |
| - 5 | 23.0   | 33 | 91.4  | 71 | 159.8 | 190  | 374.0  |
| - 4 | 24.8   | 34 | 93.2  | 72 | 161.6 | 200  | 392.0  |
| - 3 | 26.6   | 35 | 95.0  | 73 | 163.4 | 220  | 428.0  |
| - 2 | 8.4    | 36 | 96.8  | 74 | 165.2 | 240  | 464.0  |
| - 1 | 30.2   | 37 | 98.6  | 75 | 167.0 | 260  | 500.0  |
| 0   | 32.0   | 38 | 100.4 | 76 | 168.8 | 280  | 536.0  |
| 1   | 33.8   | 39 | 102.2 | 77 | 170.6 | 300  | 572.0  |
| 2   | 35.6   | 40 | 104.0 | 78 | 172.4 | 400  | 752.0  |
| 4   | 39.2   | 42 | 107.6 | 80 | 176.0 | 600  | 1112.0 |
| 5   | 41.0   | 43 | 109.4 | 81 | 177.8 | 700  | 1292.0 |
| 6   | 42.8   | 44 | 111.2 | 82 | 179.6 | 800  | 1472.0 |
| 7   | 44.6   | 45 | 113.0 | 83 | 181.4 | 900  | 1652.0 |
| 8   | 46.4   | 46 | 114.8 | 84 | 183.2 | 1000 | 1832.0 |

C = 5/9 (F - 32)  
F = 9/5 C + 32

<sup>1</sup> Magnet wire tensile will change as the psi of magnet wire changes.

**Note:** Copper magnet wire is calculated at 33,000 psi. Aluminum magnet wire is calculated at 11,000 psi (EC grade). Magnet wire should be tensiled on each coil. After termination of the AMPLIVAR splice, the tensile strength will be 70% (min.) of the original magnet wire tensile values.



**Technical Information** (Continued)

**Circular Mil Area (CMA) and diameter for magnet wires (AWG wire size range 52–25 1/2)**

| AWG Bare Wire | Bare Wire Dia. |      | CMA Bare | Single Film Coated Dia. |      | CMA Single Film Coated | Heavy Film Coated Dia. |      | CMA Heavy Film Coated |
|---------------|----------------|------|----------|-------------------------|------|------------------------|------------------------|------|-----------------------|
|               | in.            | mm   |          | in.                     | mm   |                        | in.                    | mm   |                       |
| 52            | .0008          | .020 | 0.6      | .0010                   | .025 | 1.0                    | .0011                  | .028 | 1.2                   |
| 51            | .0009          | .023 | 0.8      | .0011                   | .028 | 1.2                    | .0012                  | .031 | 1.5                   |
| 50            | .0010          | .025 | 1.0      | .0012                   | .031 | 1.5                    | .0013                  | .033 | 1.7                   |
| 49            | .0011          | .028 | 1.2      | .0013                   | .033 | 1.7                    | .0014                  | .035 | 2.0                   |
| 48            | .0012          | .031 | 1.5      | .0014                   | .035 | 2.0                    | .0015                  | .038 | 2.2                   |
| 47            | .0014          | .035 | 2.0      | .0016                   | .040 | 2.5                    | .0018                  | .045 | 3.1                   |
| 46            | .0016          | .040 | 2.5      | .0017                   | .043 | 2.9                    | .0019                  | .048 | 3.6                   |
| 45            | .0018          | .045 | 3.1      | .0019                   | .048 | 3.6                    | .0021                  | .053 | 4.4                   |
| 44            | .0020          | .050 | 4.0      | .0022                   | .056 | 4.8                    | .0025                  | .063 | 6.2                   |
| 43            | .0022          | .056 | 4.8      | .0025                   | .063 | 6.2                    | .0027                  | .069 | 7.3                   |
| 42            | .0025          | 0.06 | 6.3      | .0028                   | 0.07 | 8                      | .0030                  | 0.08 | 9                     |
| 41            | .0028          | 0.07 | 7.8      | .0031                   | 0.08 | 10                     | .0034                  | 0.09 | 12                    |
| 40            | .0031          | 0.08 | 9.6      | .0035                   | 0.09 | 12                     | .0038                  | 0.10 | 14                    |
| 39            | .0035          | 0.09 | 12       | .0039                   | 0.10 | 15                     | .0043                  | 0.11 | 18                    |
| 38            | .0040          | 0.10 | 16       | .0045                   | 0.11 | 20                     | .0049                  | 0.12 | 24                    |
| 37            | .0045          | 0.11 | 20       | .0050                   | 0.13 | 25                     | .0055                  | 0.14 | 30                    |
| 36            | .0050          | 0.13 | 25       | .0056                   | 0.14 | 31                     | .0060                  | 0.15 | 36                    |
| 35            | .0056          | 0.14 | 31       | .0062                   | 0.16 | 38                     | .0067                  | 0.17 | 45                    |
| 35            | .0056          | 0.14 | 31       | .0062                   | 0.16 | 38                     | .0067                  | 0.17 | 45                    |
| 34            | .0063          | 0.16 | 40       | .0069                   | 0.18 | 48                     | .0075                  | 0.19 | 56                    |
| 33            | .0071          | 0.18 | 50       | .0077                   | 0.20 | 59                     | .0085                  | 0.22 | 72                    |
| 32            | .0080          | 0.20 | 64       | .0084                   | 0.21 | 71                     | .0095                  | 0.24 | 90                    |
| 31            | .0089          | 0.23 | 79       | .0092                   | 0.23 | 85                     | .0105                  | 0.27 | 110                   |
| 30 1/2        | .0095          | 0.24 | 90       | .0099                   | 0.25 | 98                     | .0111                  | 0.28 | 123                   |
| 30            | .0100          | 0.25 | 100      | .0106                   | 0.27 | 112                    | .0116                  | 0.29 | 135                   |
| 29 1/2        | .0107          | 0.27 | 115      | .0114                   | 0.29 | 130                    | .0123                  | 0.31 | 151                   |
| 29            | .0113          | 0.29 | 128      | .0120                   | 0.30 | 144                    | .0130                  | 0.33 | 169                   |
| 28 1/2        | .0120          | 0.30 | 144      | .0126                   | 0.32 | 159                    | .0137                  | 0.35 | 187                   |
| 28            | .0126          | 0.32 | 159      | .0136                   | 0.35 | 185                    | .0144                  | 0.37 | 207                   |
| 27 1/2        | .0134          | 0.34 | 180      | .0144                   | 0.37 | 207                    | .0153                  | 0.39 | 234                   |
| 27            | .0142          | 0.36 | 202      | .0152                   | 0.39 | 231                    | .0161                  | 0.41 | 259                   |
| 26 1/2        | .0151          | 0.38 | 225      | .0160                   | 0.41 | 256                    | .0170                  | 0.43 | 289                   |
| 26            | .0159          | 0.40 | 258      | .0170                   | 0.43 | 289                    | .0179                  | 0.45 | 320                   |
| 25 1/2        | .0169          | 0.43 | 289      | .0180                   | 0.46 | 324                    | .0190                  | 0.48 | 361                   |

**Technical Information** (Continued)

**Circular Mil Area (CMA) and diameter for magnet wires (AWG wire size range 25–8)**

| AWG Bare Wire     | Bare Wire Dia. |      | CMA Bare | Single Film Coated Dia. |      | CMA Single Film Coated | Heavy Film Coated Dia. |      | CMA Heavy Film Coated |
|-------------------|----------------|------|----------|-------------------------|------|------------------------|------------------------|------|-----------------------|
|                   | in.            | mm   |          | in.                     | mm   |                        | in.                    | mm   |                       |
| 25                | .0179          | 0.45 | 320      | .0190                   | 0.48 | 361                    | .0200                  | 0.51 | 400                   |
| 24 <sup>1/2</sup> | .0190          | 0.48 | 361      | .0200                   | 0.51 | 400                    | .0212                  | 0.54 | 449                   |
| 24                | .0201          | 0.51 | 404      | .0213                   | 0.54 | 455                    | .0223                  | 0.57 | 497                   |
| 23 <sup>1/2</sup> | .0214          | 0.54 | 458      | .0226                   | 0.57 | 511                    | .0236                  | 0.60 | 557                   |
| 23                | .0226          | 0.57 | 511      | .0238                   | 0.60 | 566                    | .0249                  | 0.63 | 620                   |
| 22 <sup>1/2</sup> | .0240          | 0.61 | 576      | .0252                   | 0.64 | 635                    | .0263                  | 0.67 | 692                   |
| 22                | .0253          | 0.64 | 640      | .0266                   | 0.68 | 708                    | .0277                  | 0.70 | 767                   |
| 21 <sup>1/2</sup> | .0269          | 0.68 | 724      | .0282                   | 0.72 | 795                    | .0293                  | 0.74 | 858                   |
| 21                | .0285          | 0.72 | 812      | .0298                   | 0.76 | 888                    | .0310                  | 0.79 | 961                   |
| 20 <sup>1/2</sup> | .0303          | 0.77 | 918      | .0315                   | 0.80 | 992                    | .0328                  | 0.83 | 1,076                 |
| 20                | .0320          | 0.81 | 1,024    | .0334                   | 0.85 | 1,116                  | .0346                  | 0.88 | 1,197                 |
| 19 <sup>1/2</sup> | .0340          | 0.86 | 1,156    | .0353                   | 0.90 | 1,246                  | .0365                  | 0.93 | 1,340                 |
| 19                | .0359          | 0.91 | 1,289    | .0373                   | 0.95 | 1,391                  | .0386                  | 0.98 | 1,490                 |
| 18 <sup>1/2</sup> | .0381          | 0.97 | 1,452    | .0395                   | 1.00 | 1,560                  | .0409                  | 1.04 | 1,673                 |
| 18                | .0403          | 1.02 | 1,624    | .0418                   | 1.06 | 1,747                  | .0431                  | 1.09 | 1,858                 |
| 17 <sup>1/2</sup> | .0428          | 1.09 | 1,832    | .0443                   | 1.13 | 1,962                  | .0456                  | 1.16 | 2,079                 |
| 17                | .0453          | 1.15 | 2,052    | .0468                   | 1.19 | 2,190                  | .0482                  | 1.22 | 2,323                 |
| 16 <sup>1/2</sup> | .0481          | 1.22 | 2,314    | .0496                   | 1.26 | 2,460                  | .0510                  | 1.30 | 2,601                 |
| 16                | .0508          | 1.29 | 2,581    | .0524                   | 1.33 | 2,746                  | .0538                  | 1.37 | 2,894                 |
| 15 <sup>1/2</sup> | .0540          | 1.37 | 2,916    | .0560                   | 1.42 | 3,136                  | .0570                  | 1.45 | 3,249                 |
| 15                | .0571          | 1.45 | 3,260    | .0587                   | 1.49 | 3,446                  | .0602                  | 1.53 | 3,624                 |
| 14 <sup>1/2</sup> | .0606          | 1.54 | 3,672    | .0622                   | 1.58 | 3,869                  | .0639                  | 1.62 | 4,082                 |
| 14                | .0641          | 1.63 | 4,109    | .0658                   | 1.67 | 4,330                  | .0675                  | 1.71 | 4,556                 |
| 13 <sup>1/2</sup> | .0681          | 1.73 | 4,638    | .0698                   | 1.77 | 4,872                  | .0711                  | 1.81 | 5,055                 |
| 13                | .0720          | 1.83 | 5,184    | .0738                   | 1.87 | 5,446                  | .0749                  | 1.90 | 5,670                 |
| 12 <sup>1/2</sup> | .0764          | 1.94 | 5,837    | .0783                   | 1.99 | 6,131                  | .0793                  | 2.01 | 6,188                 |
| 12                | .0808          | 2.05 | 6,529    | .0827                   | 2.10 | 6,839                  | .0838                  | 2.13 | 7,090                 |
| 11 <sup>1/2</sup> | .0858          | 2.18 | 7,362    | .0877                   | 2.23 | 7,691                  | .0888                  | 2.26 | 7,885                 |
| 11                | .0907          | 2.30 | 8,226    | .0927                   | 2.35 | 8,593                  | .0938                  | 2.38 | 8,892                 |
| 10 <sup>1/2</sup> | .0963          | 2.35 | 9,274    | .0983                   | 2.50 | 9,663                  | .0994                  | 2.52 | 9,880                 |
| 10                | .1019          | 2.59 | 10,384   | .1040                   | 2.64 | 10,820                 | .1050                  | 2.67 | 11,151                |
| 9                 | .1144          | 2.91 | 13,087   | .1166                   | 2.96 | 13,600                 | .1177                  | 2.99 | 13,971                |
| 8                 | .1285          | 3.26 | 16,512   | .1307                   | 3.32 | 17,080                 | .1318                  | 3.35 | 17,530                |

**Technical Information** (Continued)

**Circular Mil Area (CMA) and diameter for lead wires (AWG wire size range 30–8)**

| Wire Size | Strands |             | Wire Area in Circ. Mils |
|-----------|---------|-------------|-------------------------|
|           | No.     | Dia. (Mils) |                         |
| 30        | 7       | 4.0         | 112                     |
| 30        | 1       | 10.0        | 100                     |
| 28        | 7       | 5.0         | 175                     |
| 28        | 19      | 3.1         | 181                     |
| 28        | 1       | 12.6        | 159                     |
| 27        | 7       | 5.6         | 219                     |
| 27        | 1       | 14.2        | 202                     |
| 26        | 6       | 6.3         | 238                     |
| 26        | 10      | 5.0         | 250                     |
| 26        | 16      | 4.0         | 256                     |
| 26        | 8       | 5.6         | 251                     |
| 26        | 1       | 15.9        | 253                     |
| 26        | 26      | 3.1         | 250                     |
| 26        | 7       | 6.3         | 278                     |
| 26        | 3       | 10.0        | 300                     |
| 26 AN     | 12      | 5.0         | 300                     |
| 25        | 10      | 5.6         | 314                     |
| 25        | 8       | 6.3         | 318                     |
| 25        | 1       | 17.9        | 320                     |
| 24        | 10      | 6.3         | 397                     |
| 24        | 8       | 7.1         | 403                     |
| 24        | 16      | 5.0         | 400                     |
| 24        | 4       | 10.0        | 400                     |
| 24        | 1       | 20.1        | 404                     |
| 24        | 26      | 4.0         | 416                     |
| 24        | 13      | 5.6         | 408                     |
| 24        | 7       | 8.0         | 448                     |
| 24        | 56      | 2.8         | 439                     |
| 24 AN     | 19      | 5.0         | 475                     |
| 23        | 10      | 7.1         | 504                     |
| 23        | 8       | 8.0         | 512                     |
| 23        | 1       | 22.6        | 511                     |
| —         | 21      | 5.0         | 525                     |
| 22        | 6       | 10.0        | 600                     |
| 22        | 8       | 8.9         | 634                     |
| 22        | 16      | 6.3         | 635                     |
| 22        | 10      | 8.0         | 640                     |
| 22        | 1       | 25.3        | 640                     |
| 22        | 7       | 10.0        | 700                     |
| 22 AN     | 19      | 6.3         | 754                     |
| 20        | 10      | 10.0        | 1,000                   |
| 20        | 1       | 10.0        | 1,024                   |
| 20        | 26      | 6.3         | 1,032                   |
| 20        | 7       | 12.6        | 1,111                   |
| 20 AN     | 19      | 7.9         | 1,186                   |
| 18        | 19      | 9.2         | 1,608                   |
| —         | 16      | 10.0        | 1,600                   |
| 18        | 1       | 40.3        | 1,624                   |
| 18        | 7       | 15.2        | 1,617                   |
| 18        | 65      | 5.0         | 1,625                   |
| 18        | 7       | 15.3        | 1,639                   |

| Wire Size | Strands |             | Wire Area in Circ. Mils |
|-----------|---------|-------------|-------------------------|
|           | No.     | Dia. (Mils) |                         |
| —         | 41      | 6.3         | 1,627                   |
| —         | 7       | 16.0        | 1,792                   |
| 18 AN     | 19      | 10.0        | 1,900                   |
| 18 AN     | 19      | 11.3        | 2,426                   |
| 16        | 7       | 19.2        | 2,580                   |
| 16        | 1       | 50.8        | 2,581                   |
| 16        | 65      | 6.3         | 2,580                   |
| 16        | 19      | 11.7        | 2,601                   |
| 16        | 105     | 5.0         | 2,625                   |
| —         | 26      | 10.0        | 2,600                   |
| 16        | 7       | 20.0        | 2,800                   |
| 14 AN     | 19      | 14.2        | 3,831                   |
| 14        | 37      | 10.5        | 4,079                   |
| 14        | 7       | 24.2        | 4,099                   |
| 14        | 19      | 14.7        | 4,106                   |
| 14        | 1       | 64.4        | 4,109                   |
| —         | 41      | 10.0        | 4,100                   |
| 14        | 105     | 6.3         | 4,167                   |
| 14        | 168     | 5.0         | 4,200                   |
| 14        | 84      | 7.1         | 4,234                   |
| —         | 7       | 25.3        | 4,481                   |
| 12        | 19      | 17.9        | 6,088                   |
| 12 AN     | 19      | 17.9        | 6,088                   |
| 12        | 259     | 5.0         | 6,475                   |
| 12        | 19      | 18.5        | 6,503                   |
| 12        | 7       | 30.5        | 6,512                   |
| 12        | 37      | 13.3        | 6,545                   |
| 12        | 1       | 80.8        | 6,529                   |
| 12        | 165     | 6.3         | 6,549                   |
| 12        | 84      | 8.9         | 6,654                   |
| 10        | 7       | 36.0        | 9,072                   |
| —         | 37      | 16.0        | 9,472                   |
| 10        | 414     | 5.0         | 10,350                  |
| 10        | 37      | 16.7        | 10,319                  |
| 10        | 1       | 101.9       | 10,384                  |
| 10        | 7       | 38.5        | 10,376                  |
| 10        | 19      | 23.4        | 10,404                  |
| —         | 41      | 15.9        | 10,365                  |
| 10        | 105     | 10.0        | 10,500                  |
| 9         | 7       | 43.0        | 12,943                  |
| 9         | 1       | 114.4       | 13,087                  |
| 9         | 525     | 5.0         | 13,125                  |
| 8         | 7       | 45.0        | 14,175                  |
| 8         | 133     | 11.1        | 16,386                  |
| 8         | 37      | 21.1        | 16,472                  |
| 8         | 1       | 128.5       | 16,512                  |
| 8         | 7       | 48.6        | 16,533                  |
| 8         | 19      | 29.5        | 16,534                  |
| 8         | 49      | 18.4        | 16,589                  |
| 8 AN      | 133     | 11.3        | 16,982                  |





















**Terminal Stud Hole Size**

**Use to Select Proper Size Terminal**

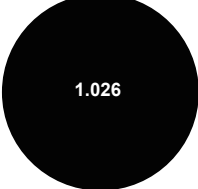
The chart shows sizes and dimensions of various studs and the corresponding terminal stud hole sizes used with devices.

For example, with stud #5 (.125 [3.18] Diameter), use device listed for #5 stud (.129 [3.28] Hole Diameter).

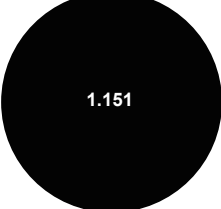
Terminal stud hole sizes may easily be checked by fitting sample terminal to black circle.

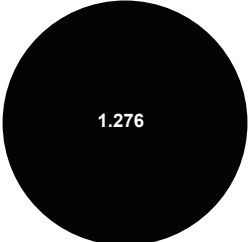
| Stud Size  |        | Stud Dia. | Minimum Terminal Hole Diameter                                                      | Stud Size  |        | Stud Dia. | Minimum Terminal Hole Diameter |                                                                                       |
|------------|--------|-----------|-------------------------------------------------------------------------------------|------------|--------|-----------|--------------------------------|---------------------------------------------------------------------------------------|
| U.S. Cust. | Metric |           |                                                                                     | U.S. Cust. | Metric |           |                                |                                                                                       |
| #0         |        | .060      |    | .064       |        |           |                                |                                                                                       |
| #1         |        | .073      |    | .077       | 5/8"   | M16       | .625                           |    |
| #2         | M2     | .086      |    | .090       |        |           |                                |                                                                                       |
| #3         |        | .099      |    | .103       |        |           |                                |                                                                                       |
| #4         |        | .112      |    | .116       | 3/4"   |           | .750                           |    |
| #5         | M3     | .125      |    | .129       |        |           |                                |                                                                                       |
| #6         | M3.5   | .138      |    | .142       |        |           |                                |                                                                                       |
| #8         | M4     | .164      |    | .168       | 7/8"   | M22       | .875                           |   |
| #10        |        | .190      |  | .194       |        |           |                                |                                                                                       |
| #12        |        | .216      |  | .220       |        |           |                                |                                                                                       |
| #14        |        | .242      |  | .247       | 1"     |           | 1.000                          |  |
| 1/4"       | M6     | .250      |  | .260       |        |           |                                |                                                                                       |
| 5/16"      | M8     | .312      |  | .323       |        |           |                                |                                                                                       |
| 3/8"       |        | .375      |  | .385       | 1-1/8" |           | 1.125                          |  |
| 7/16"      |        | .437      |  | .448       |        |           |                                |                                                                                       |
| 1/2"       | M12    | .500      |  | .510       | 1-1/4" |           | 1.250                          |  |

**Part Number Index**

**Note:** This index lists all cataloged parts by base no. only. Complete part nos. (with prefixes and/or suffixes) are shown on the page(s) indicated.

| Part No. | Page | Part No. | Page | Part No. | Page |
|----------|------|----------|------|----------|------|
| 41765    | 48   | 62445    | 53   | 63240    | 10   |
| 41766    | 48   | 62447    | 53   | 63253    | 11   |
| 41770    | 48   | 62458    | 10   | 63273    | 18   |
| 41899    | 48   | 62459    | 10   | 63277    | 16   |
| 41900    | 48   | 62511    | 18   | 63278    | 16   |
| 41904    | 48   | 62512    | 18   | 63309    | 21   |
| 42076    | 48   | 62513    | 18   | 63340    | 19   |
| 42119    | 48   | 62514    | 18   | 63353    | 20   |
| 42192    | 48   | 62600    | 21   | 63364    | 7    |
| 42776    | 48   | 62606    | 30   | 63397    | 7    |
| 42778    | 48   | 62609    | 10   | 63399    | 51   |
| 42779    | 48   | 62610    | 10   | 63403    | 21   |
| 42780    | 48   | 62651    | 21   | 63410    | 7    |
| 60177    | 55   | 62652    | 21   | 63425    | 22   |
| 60318    | 51   | 62670    | 49   | 63427    | 20   |
| 60319    | 51   | 62678    | 18   | 63429    | 19   |
| 60320    | 51   | 62702    | 13   | 63431    | 49   |
| 60321    | 51   | 62743    | 19   | 63443    | 16   |
| 60322    | 51   | 62755    | 51   | 63444    | 16   |
| 60323    | 51   | 62780    | 30   | 63446    | 51   |
| 60325    | 51   | 62781    | 30   | 63448    | 59   |
| 60384    | 54   | 62833    | 4    | 63453    | 61   |
| 60385    | 54   | 62835    | 51   | 63454    | 61   |
| 60752    | 52   | 62888    | 19   | 63455    | 61   |
| 61074    | 48   | 62891    | 7    | 63458    | 8    |
| 61151    | 52   | 62896    | 7    | 63459    | 22   |
| 61166    | 49   | 62897    | 7    | 63460    | 22   |
| 61440    | 53   | 62898    | 7    | 63461    | 18   |
| 61442    | 53   | 62904    | 18   | 63463    | 14   |
| 61710    | 52   | 62922    | 53   | 63464    | 22   |
| 62000    | 47   | 62923    | 22   | 63465    | 22   |
| 62001    | 47   | 62928    | 11   | 63480    | 56   |
| 62002    | 47   | 62935    | 4    | 63484    | 53   |
| 62040    | 47   | 62938    | 13   | 63486    | 17   |
| 62044    | 49   | 62958    | 11   | 63489    | 14   |
| 62069    | 54   | 62992    | 10   | 63495    | 22   |
| 62080    | 54   | 63018    | 18   | 63499    | 21   |
| 62131    | 59   | 63026    | 21   | 63504    | 10   |
| 62157    | 47   | 63027    | 21   | 63506    | 55   |
| 62194    | 49   | 63036    | 10   | 63561    | 48   |
| 62200    | 47   | 63039    | 10   | 63562    | 48   |
| 62201    | 47   | 63062    | 17   | 63564    | 48   |
| 62243    | 61   | 63063    | 17   | 63565    | 13   |
| 62244    | 61   | 63064    | 22   | 63569    | 16   |
| 62295    | 47   | 63107    | 19   | 63570    | 16   |
| 62303    | 47   | 63108    | 19   | 63571    | 21   |
| 62304    | 47   | 63109    | 19   | 63584    | 18   |
| 62305    | 47   | 63128    | 21   | 63585    | 18   |
| 62306    | 47   | 63132    | 21   | 63591    | 4    |
| 62307    | 47   | 63136    | 54   | 63601    | 21   |
| 62308    | 47   | 63140    | 54   | 63607    | 21   |
| 62309    | 47   | 63145    | 17   | 63612    | 51   |
| 62310    | 47   | 63147    | 51   | 63613    | 30   |
| 62311    | 47   | 63155    | 22   | 63614    | 21   |
| 62341    | 49   | 63160    | 13   | 63621    | 49   |
| 62381    | 56   | 63165    | 54   | 63622    | 54   |
| 62420    | 4    | 63199    | 31   | 63623    | 54   |
| 62429    | 4    | 63216    | 14   | 63632    | 6    |
| 62430    | 13   | 63218    | 7    | 63641    | 10   |
| 62431    | 4    | 63235    | 10   | 63649    | 51   |
| 62438    | 13   | 63236    | 10   | 63658    | 4    |
| 62439    | 13   | 63237    | 10   | 63659    | 11   |

**Part Number Index**

| Part No. | Page | Part No. | Page | Part No. | Page | Part No. | Page |
|----------|------|----------|------|----------|------|----------|------|
| 63660    | 11   | 63942    | 55   | 964114   | 5    | 1217529  | 31   |
| 63661    | 11   | 63964    | 56   | 964156   | 47   | 1217533  | 6    |
| 63662    | 4    | 63965    | 14   | 964252   | 5    | 1217538  | 9    |
| 63663    | 18   | 63972    | 14   | 964290   | 7    | 1217579  | 6    |
| 63664    | 18   | 63973    | 14   | 964337   | 5    | 1217592  | 19   |
| 63665    | 18   | 63974    | 14   | 964338   | 5    | 1217593  | 14   |
| 63666    | 20   | 63975    | 6    | 964339   | 5    | 1217595  | 14   |
| 63667    | 20   | 63983    | 20   | 964340   | 5    | 1217596  | 14   |
| 63670    | 18   | 63995    | 20   | 964341   | 5    | 1217613  | 9    |
| 63675    | 31   | 63996    | 20   | 969082   | 5    | 1217624  | 55   |
| 63690    | 10   | 160809   | 13   | 969125   | 8    | 1217666  | 26   |
| 63710    | 26   | 160810   | 13   | 1123655  | 59   | 1217688  | 6    |
| 63711    | 26   | 160897   | 13   | 1217004  | 19   | 1217689  | 6    |
| 63712    | 26   | 170063   | 59   | 1217011  | 4    | 1217690  | 6    |
| 63713    | 26   | 171370   | 58   | 1217013  | 13   | 1217691  | 6    |
| 63714    | 26   | 235080   | 58   | 1217029  | 53   | 1217745  | 14   |
| 63716    | 26   | 281006   | 58   | 1217041  | 8    | 1217746  | 14   |
| 63717    | 26   | 281622   | 7    | 1217042  | 20   | 1217783  | 17   |
| 63718    | 26   | 281633   | 7    | 1217065  | 18   | 1217835  | 54   |
| 63719    | 26   | 284937   | 41   | 1217067  | 6    | 1217853  | 9    |
| 63720    | 26   | 293029   | 40   | 1217068  | 6    | 1217858  | 9    |
| 63734    | 26   | 293214   | 38   | 1217069  | 6    | 1217860  | 21   |
| 63735    | 26   | 316300   | 18   | 1217072  | 53   | 1217870  | 21   |
| 63736    | 26   | 350571   | 52   | 1217073  | 53   | 1217902  | 20   |
| 63737    | 26   | 353937   | 59   | 1217075  | 20   | 1217924  | 21   |
| 63738    | 26   | 356462   | 55   | 1217090  | 20   | 1217973  | 9    |
| 63740    | 26   | 360033   | 58   | 1217128  | 18   | 1247000  | 11   |
| 63741    | 26   | 360050   | 58   | 1217146  | 10   | 1247001  | 11   |
| 63742    | 26   | 360051   | 60   | 1217152  | 21   | 1247002  | 11   |
| 63743    | 26   | 360052   | 60   | 1217172  | 61   | 1247003  | 11   |
| 63744    | 26   | 466010   | 54   | 1217173  | 61   | 1247004  | 11   |
| 63746    | 17   | 466510   | 53   | 1217174  | 61   | 1380145  | 58   |
| 63762    | 20   | 466816   | 54   | 1217175  | 61   | 1394403  | 15   |
| 63772    | 16   | 485044   | 51   | 1217176  | 61   | 1394429  | 12   |
| 63775    | 7    | 485079   | 51   | 1217181  | 60   | 1394430  | 12   |
| 63776    | 18   | 505036   | 52   | 1217186  | 60   | 1394431  | 12   |
| 63777    | 17   | 505044   | 52   | 1217187  | 60   | 1394432  | 12   |
| 63778    | 31   | 505071   | 51   | 1217196  | 13   | 1394433  | 12   |
| 63782    | 19   | 505072   | 51   | 1217200  | 60   | 1394475  | 15   |
| 63786    | 4    | 505075   | 51   | 1217209  | 9    | 1394476  | 15   |
| 63788    | 16   | 505079   | 52   | 1217221  | 6    | 1394638  | 15   |
| 63789    | 4    | 520995   | 60   | 1217234  | 4    | 1394639  | 15   |
| 63795    | 30   | 521078   | 58   | 1217261  | 60   | 1418686  | 8    |
| 63806    | 14   | 565435   | 53   | 1217262  | 58   | 1534110  | 8    |
| 63807    | 14   | 566410   | 55   | 1217264  | 59   | 1534234  | 5    |
| 63808    | 14   | 566411   | 55   | 1217302  | 11   | 1534684  | 26   |
| 63810    | 14   | 567343   | 54   | 1217324  | 8    | 1534685  | 26   |
| 63816    | 22   | 567451   | 54   | 1217339  | 20   | 1534686  | 26   |
| 63818    | 13   | 640212   | 52   | 1217355  | 6    | 1534687  | 26   |
| 63819    | 13   | 680353   | 55   | 1217356  | 6    | 1599105  | 59   |
| 63827    | 17   | 880631   | 58   | 1217357  | 6    | 1601000  | 36   |
| 63844    | 30   | 926850   | 5    | 1217358  | 6    | 1601002  | 41   |
| 63856    | 10   | 926851   | 5    | 1217368  | 4    | 1601005  | 39   |
| 63864    | 52   | 926852   | 5    | 1217384  | 48   | 1601006  | 40   |
| 63870    | 53   | 928770   | 5    | 1217405  | 13   | 1601009  | 38   |
| 63871    | 53   | 928771   | 5    | 1217406  | 8    | 1601011  | 40   |
| 63888    | 27   | 928854   | 5    | 1217417  | 55   | 1601013  | 40   |
| 63889    | 53   | 964101   | 7    | 1217457  | 9    | 1601018  | 40   |
| 63899    | 14   | 964106   | 5    | 1217458  | 9    | 1601020  | 40   |
| 63903    | 27   | 964108   | 5    | 1217493  | 19   | 1601021  | 40   |
| 63940    | 55   | 964110   | 5    | 1217497  | 26   | 1601028  | 41   |
| 63941    | 55   | 964111   | 5    | 1217516  | 26   | 1601033  | 40   |



**Part Number Index**

| Part No. | Page | Part No. | Page | Part No. | Page | Part No. | Page |
|----------|------|----------|------|----------|------|----------|------|
| 1601035  | 40   | 1601436  | 42   | 1601611  | 73   | 1601721  | 72   |
| 1601037  | 38   | 1601437  | 42   | 1601612  | 73   | 1601722  | 72   |
| 1601039  | 39   | 1601438  | 42   | 1601614  | 72   | 1601723  | 72   |
| 1601041  | 38   | 1601440  | 42   | 1601617  | 72   | 1601726  | 71   |
| 1601045  | 39   | 1601447  | 42   | 1601618  | 72   | 1601729  | 71   |
| 1601046  | 36   | 1601475  | 42   | 1601619  | 72   | 1601730  | 71   |
| 1601049  | 40   | 1601503  | 73   | 1601620  | 70   | 1601731  | 71   |
| 1601052  | 41   | 1601504  | 73   | 1601623  | 70   | 1601733  | 71   |
| 1601056  | 36   | 1601507  | 70   | 1601625  | 70   | 1601750  | 64   |
| 1601058  | 40   | 1601511  | 72   | 1601628  | 70   | 1601754  | 71   |
| 1601059  | 39   | 1601513  | 72   | 1601629  | 70   | 1601755  | 71   |
| 1601061  | 41   | 1601514  | 70   | 1601630  | 70   | 1601761  | 64   |
| 1601063  | 38   | 1601520  | 69   | 1601631  | 70   | 1601764  | 71   |
| 1601064  | 39   | 1601528  | 71   | 1601632  | 68   | 1601765  | 71   |
| 1601066  | 38   | 1601529  | 71   | 1601633  | 68   | 1601766  | 71   |
| 1601068  | 40   | 1601531  | 71   | 1601635  | 73   | 1601768  | 69   |
| 1601072  | 40   | 1601532  | 71   | 1601637  | 65   | 1601769  | 68   |
| 1601073  | 39   | 1601538  | 65   | 1601639  | 64   | 1601771  | 68   |
| 1601074  | 36   | 1601539  | 65   | 1601640  | 72   | 1601793  | 65   |
| 1601075  | 37   | 1601540  | 65   | 1601642  | 71   | 1601794  | 64   |
| 1601077  | 37   | 1601542  | 73   | 1601644  | 65   | 1601795  | 73   |
| 1601095  | 38   | 1601545  | 73   | 1601646  | 65   | 1601797  | 69   |
| 1601097  | 39   | 1601546  | 73   | 1601647  | 65   | 1601798  | 69   |
| 1601099  | 38   | 1601547  | 73   | 1601649  | 73   | 1601800  | 65   |
| 1601104  | 38   | 1601548  | 72   | 1601650  | 72   | 1601807  | 69   |
| 1601110  | 38   | 1601549  | 72   | 1601651  | 72   | 1601808  | 72   |
| 1601112  | 39   | 1601550  | 69   | 1601652  | 72   | 1601809  | 72   |
| 1601115  | 41   | 1601551  | 69   | 1601654  | 72   | 1601810  | 72   |
| 1601117  | 36   | 1601553  | 69   | 1601655  | 70   | 1601811  | 70   |
| 1601118  | 41   | 1601555  | 73   | 1601656  | 70   | 1601814  | 64   |
| 1601119  | 38   | 1601559  | 65   | 1601658  | 70   | 1601818  | 70   |
| 1601120  | 38   | 1601560  | 65   | 1601660  | 70   | 1601819  | 70   |
| 1601128  | 38   | 1601562  | 73   | 1601661  | 70   | 1601820  | 70   |
| 1601133  | 39   | 1601564  | 73   | 1601664  | 70   | 1601823  | 64   |
| 1601136  | 36   | 1601566  | 72   | 1601665  | 70   | 1601824  | 64   |
| 1601137  | 37   | 1601569  | 72   | 1601667  | 70   | 1601825  | 73   |
| 1601138  | 38   | 1601571  | 72   | 1601668  | 70   | 1601827  | 72   |
| 1601139  | 41   | 1601572  | 69   | 1601669  | 69   | 1601828  | 70   |
| 1601140  | 36   | 1601573  | 69   | 1601675  | 65   | 1601829  | 70   |
| 1601142  | 40   | 1601575  | 68   | 1601677  | 64   | 1601832  | 65   |
| 1601155  | 38   | 1601577  | 68   | 1601678  | 64   | 1601833  | 64   |
| 1601159  | 41   | 1601578  | 68   | 1601680  | 71   | 1601835  | 64   |
| 1601161  | 41   | 1601580  | 73   | 1601681  | 71   | 1601837  | 72   |
| 1601174  | 40   | 1601582  | 73   | 1601682  | 71   | 1601841  | 71   |
| 1601194  | 39   | 1601583  | 73   | 1601683  | 65   | 1601842  | 64   |
| 1601196  | 37   | 1601584  | 73   | 1601687  | 72   | 1601844  | 65   |
| 1601204  | 39   | 1601586  | 72   | 1601689  | 71   | 1601845  | 65   |
| 1601214  | 38   | 1601587  | 70   | 1601691  | 71   | 1601846  | 64   |
| 1601226  | 40   | 1601588  | 70   | 1601693  | 71   | 1601847  | 64   |
| 1601232  | 37   | 1601591  | 70   | 1601694  | 71   | 1601848  | 64   |
| 1601237  | 36   | 1601593  | 68   | 1601695  | 71   | 1601852  | 71   |
| 1601243  | 38   | 1601596  | 73   | 1601705  | 64   | 1601853  | 68   |
| 1601421  | 42   | 1601597  | 72   | 1601706  | 64   | 1601857  | 64   |
| 1601424  | 42   | 1601599  | 72   | 1601707  | 64   | 1601953  | 75   |
| 1601425  | 42   | 1601600  | 72   | 1601709  | 71   | 1718165  | 30   |
| 1601426  | 42   | 1601601  | 70   | 1601710  | 71   | 1740417  | 15   |
| 1601427  | 42   | 1601603  | 70   | 1601711  | 71   | 1740418  | 15   |
| 1601431  | 42   | 1601604  | 65   | 1601712  | 71   | 1740419  | 15   |
| 1601432  | 42   | 1601606  | 65   | 1601716  | 65   | 1740574  | 5    |
| 1601433  | 42   | 1601607  | 64   | 1601717  | 64   | 1740603  | 8    |
| 1601434  | 42   | 1601608  | 64   | 1601718  | 64   | 1740698  | 8    |
| 1601435  | 42   | 1601610  | 73   | 1601719  | 64   | 1740829  | 26   |

**Part Number Index**

| Part No. | Page |
|----------|------|
| 1742125  | 7    |
| 1742159  | 9    |
| 1742160  | 18   |
| 1742167  | 14   |
| 1742203  | 6    |
| 1742211  | 8    |
| 1742347  | 6    |
| 1742398  | 21   |
| 1742410  | 8    |
| 1742605  | 13   |
| 1742614  | 10   |
| 1742657  | 61   |

| Part No. | Page |
|----------|------|
| 1742708  | 11   |
| 1742781  | 9    |
| 1742819  | 20   |
| 1742820  | 20   |
| 1742828  | 7    |
| 1742881  | 55   |
| 1742882  | 55   |
| 1742898  | 47   |
| 1742964  | 59   |
| 1742977  | 55   |
| 1742979  | 55   |
| 1742981  | 59   |

| Part No. | Page |
|----------|------|
| 1855633  | 55   |
| 1855634  | 55   |
| 1855680  | 55   |
| 1855681  | 55   |
| 1955415  | 58   |
| 1969357  | 58   |
| 1987143  | 12   |
| 1987199  | 8    |
| 1987222  | 28   |
| 1987223  | 28   |
| 1987224  | 28   |
| 1987225  | 28   |

| Part No. | Page |
|----------|------|
| 1987226  | 28   |
| 2120743  | 27   |
| 2120744  | 27   |
| 2120745  | 27   |
| 2120746  | 27   |
| 2120747  | 27   |
| 2232326  | 58   |
| 2232327  | 58   |
| 2825082  | 58   |
| 2825083  | 59   |

---

**Engineering Notes**

---



---

**Engineering Notes**

---



---

**Engineering Notes**

---



## LET'S CONNECT

We make it easy to connect with our experts and are ready to provide all the support you need. Just call your local support number or visit [www.te.com/appliances](http://www.te.com/appliances) to chat with a Product Information Specialist.

## TECHNICAL SUPPORT

[te.com/support-center](http://te.com/support-center)

|                      |                   |                   |                  |                      |                  |
|----------------------|-------------------|-------------------|------------------|----------------------|------------------|
| Australia .....      | +86 400-820-6015  | Hungary .....     | +36 1-2892040    | Portugal .....       | +34 91-6630420   |
| Austria .....        | +43 1-9056-0      | India .....       | +86 400-820-6015 | Russia .....         | +74 95-790-2200  |
| Belgium .....        | +31 73-6246999    | Ireland .....     | +1 800-882-391   | Slovakia .....       | +42 02-720-11102 |
| Brazil .....         | +55 11-2103-6000  | Italy .....       | +39 011-4012111  | Slovenia .....       | +38 615-602-132  |
| China .....          | +86 400-820-6015  | Japan .....       | +044-844-8052    | South Africa .....   | +97 150-457-0806 |
| Czech Republic ..... | +42 02-7201-1103  | Korea .....       | +02-3415-4607    | Spain .....          | +34 932-910-330  |
| Denmark .....        | +46 8-5072-5000   | Latvia .....      | +37 2-6778-673   | Sweden .....         | +46 8-5072-5000  |
| Estonia .....        | +37 2677-8673     | Lithuania .....   | +37 037426900    | Switzerland .....    | +41 71-447-0447  |
| Finland .....        | +46 8-5072-5000   | Luxembourg .....  | +31 73-6246999   | Taiwan .....         | +86 400-820-6015 |
| France .....         | +33 1-34-20-8686  | Netherlands ..... | +31 73-6246999   | Turkey .....         | +90 212-282-6053 |
| Germany .....        | +49 6151-607-1999 | New Zealand ..... | +86 400-820-6015 | United Kingdom ..... | +44 800-267666   |
| Greece .....         | +97 1-4-347-0226  | Norway .....      | +46 8-5072-5000  | USA .....            | 800-522-6752     |
| Holland .....        | +31 73-6246999    | Poland .....      | +48 22-4576750   |                      |                  |

## te.com

TE Connectivity, TE Connectivity (logo), Every Connection Counts, AMP, AMP-O-LECTRIC, AMPLIVAR, AMPOMATOR, CERTI-LOK, DYNA-CRIMP, FASTIN-FASTON, FASTON, MAG-MATE and SIAMEZE are trademarks. All other logos, products and/or company names referred to herein might be trademarks of their respective owners.

The information given herein, including drawings, illustrations and schematics which are intended for illustration purposes only, is believed to be reliable. However, TE Connectivity makes no warranties as to its accuracy or completeness and disclaims any liability in connection with its use. TE Connectivity's obligations shall only be as set forth in TE Connectivity's Standard Terms and Conditions of Sale for this product and in no case will TE Connectivity be liable for any incidental, indirect or consequential damages arising out of the sale, resale, use or misuse of the product. Users of TE Connectivity products should make their own evaluation to determine the suitability of each such product for the specific application.

© 2016 TE Connectivity Ltd. family of companies All Rights Reserved.

82221 06/2016 APP



Компания «Океан Электроники» предлагает заключение долгосрочных отношений при поставках импортных электронных компонентов на взаимовыгодных условиях!

Наши преимущества:

- Поставка оригинальных импортных электронных компонентов напрямую с производств Америки, Европы и Азии, а так же с крупнейших складов мира;
- Широкая линейка поставок активных и пассивных импортных электронных компонентов (более 30 млн. наименований);
- Поставка сложных, дефицитных, либо снятых с производства позиций;
- Оперативные сроки поставки под заказ (от 5 рабочих дней);
- Экспресс доставка в любую точку России;
- Помощь Конструкторского Отдела и консультации квалифицированных инженеров;
- Техническая поддержка проекта, помощь в подборе аналогов, поставка прототипов;
- Поставка электронных компонентов под контролем ВП;
- Система менеджмента качества сертифицирована по Международному стандарту ISO 9001;
- При необходимости вся продукция военного и аэрокосмического назначения проходит испытания и сертификацию в лаборатории (по согласованию с заказчиком);
- Поставка специализированных компонентов военного и аэрокосмического уровня качества (Xilinx, Altera, Analog Devices, Intersil, Interpoint, Microsemi, Actel, Aeroflex, Peregrine, VPT, Syfer, Eurofarad, Texas Instruments, MS Kennedy, Miteq, Cobham, E2V, MA-COM, Hittite, Mini-Circuits, General Dynamics и др.);

Компания «Океан Электроники» является официальным дистрибьютором и эксклюзивным представителем в России одного из крупнейших производителей разъемов военного и аэрокосмического назначения «JONHON», а так же официальным дистрибьютором и эксклюзивным представителем в России производителя высокотехнологичных и надежных решений для передачи СВЧ сигналов «FORSTAR».



## JONHON

«JONHON» (основан в 1970 г.)

Разъемы специального, военного и аэрокосмического назначения:

(Применяются в военной, авиационной, аэрокосмической, морской, железнодорожной, горно- и нефтедобывающей отраслях промышленности)

«FORSTAR» (основан в 1998 г.)

ВЧ соединители, коаксиальные кабели, кабельные сборки и микроволновые компоненты:

(Применяются в телекоммуникациях гражданского и специального назначения, в средствах связи, РЛС, а так же военной, авиационной и аэрокосмической отраслях промышленности).



Телефон: 8 (812) 309-75-97 (многоканальный)

Факс: 8 (812) 320-03-32

Электронная почта: [ocean@oceanchips.ru](mailto:ocean@oceanchips.ru)

Web: <http://oceanchips.ru/>

Адрес: 198099, г. Санкт-Петербург, ул. Калинина, д. 2, корп. 4, лит. А