



7-Channel Precision Temperature Monitor

MAX6697

General Description

The MAX6697 precision multichannel temperature sensor monitors its own temperature and the temperatures of up to six external diode-connected transistors. All temperature channels have programmable alert thresholds. Channels 1, 4, 5, and 6 also have programmable overtemperature thresholds. When the measured temperature of a channel exceeds the respective threshold, a status bit is set in one of the status registers. Two open-drain outputs, $\overline{\text{OVERT}}$ and $\overline{\text{ALERT}}$, assert corresponding to these bits in the status register.

The 2-wire serial interface supports the standard system management bus (SMBus™) protocols: write byte, read byte, send byte, and receive byte for reading the temperature data and programming the alarm thresholds.

The MAX6697 is specified for an operating temperature range of -40°C to +125°C and is available in 20-pin QSOP and 20-pin TSSOP packages.

Applications

- Desktop Computers
- Notebook Computers
- Workstations
- Servers

SMBus is a trademark of Intel Corp.

Features

- ◆ Six Thermal-Diode Inputs
- ◆ Local Temperature Sensor
- ◆ 1°C Remote Temperature Accuracy (+60°C to +100°C)
- ◆ Temperature Monitoring Begins at POR for Fail-Safe System Protection
- ◆ $\overline{\text{ALERT}}$ and $\overline{\text{OVERT}}$ Outputs for Interrupts, Throttling, and Shutdown
- ◆ Small 20-Pin QSOP and 20-Pin TSSOP Packages
- ◆ 2-Wire SMBus Interface

Ordering Information

PART	TEMP RANGE	PIN-PACKAGE
MAX6697EP_ _	-40°C to +125°C	20 QSOP
MAX6697UP_ _	-40°C to +125°C	20 TSSOP

*See the Slave Address section.

Pin Configuration appears at end of data sheet.

Typical Application Circuit

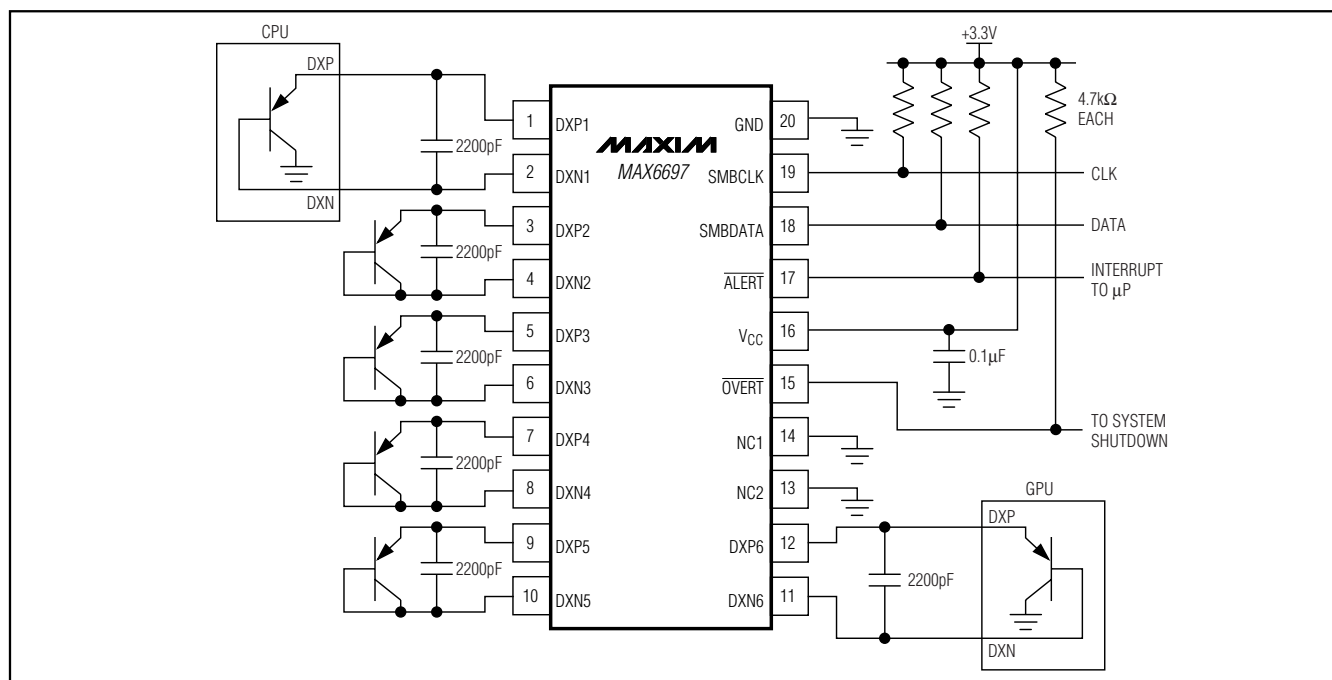

7-Channel Precision Temperature Monitor

ABSOLUTE MAXIMUM RATINGS

V_{CC}, SCK, SDA, ALERT, OVERT to GND-0.3V to +6V
 DXP_ to GND-0.3V to (V_{CC} + 0.3V)
 DXN_ to GND-0.3V to +0.8V
 SDA, ALERT, OVERT Current-1mA to +50mA
 DXN Current±1mA
 Continuous Power Dissipation (T_A = +70°C)
 20-Pin QSOP
 (derate 9.1mW/°C above +70°C)727.3mW(E20-1)

20-Pin TSSOP
 (derate 11.0mW/°C above +70°C)879.1mW(U20-2)
 ESD Protection (all pins, Human Body Model)±2000V
 Operating Temperature Range-40°C to +125°C
 Junction Temperature+150°C
 Storage Temperature Range-60°C to +150°C
 Lead Temperature (soldering, 10s)+300°C

Stresses beyond those listed under "Absolute Maximum Ratings" may cause permanent damage to the device. These are stress ratings only, and functional operation of the device at these or any other conditions beyond those indicated in the operational sections of the specifications is not implied. Exposure to absolute maximum rating conditions for extended periods may affect device reliability.

ELECTRICAL CHARACTERISTICS

(V_{CC} = +3.0V to +5.5V, T_A = -40°C to +125°C, unless otherwise noted. Typical values are at V_{CC} = +3.3V and T_A = +25°C.) (Note 1)

PARAMETER	SYMBOL	CONDITIONS	MIN	TYP	MAX	UNITS
Supply Voltage	V _{CC}		3.0		5.5	V
Standby Supply Current	I _{SS}	SMBus static		30		μA
Operating Current	I _{CC}	During conversion		500	1000	μA
Temperature Resolution		Channel 1 only		11		Bits
		Other diode channels		8		
Remote Temperature Accuracy	V _{CC} = 3.3V	T _A = T _{RJ} = +60°C to +100°C	-1.0		+1.0	°C
		T _A = T _{RJ} = 0°C to +125°C	-3.0		+3.0	
		DXN_ grounded, T _{RJ} = T _A = 0°C to +85°C			±2.5	
Local Temperature Accuracy	V _{CC} = 3.3V	T _A = +60°C to +100°C	-2.0		+2.0	°C
		T _A = 0°C to +125°C	-3.0		+3.0	
Supply Sensitivity of Temperature Accuracy				±0.2		°C/V
Remote Channel 1 Conversion Time	t _{CONV1}	Resistance cancellation on	95	125	156	ms
		Resistance cancellation off	190	250	312	
Remote Channels 2 Through 6 Conversion Time	t _{CONV_}		95	125	156	ms
Remote-Diode Source Current	I _{RJ}	High level	80	100	120	μA
		Low level	8	10	12	
Undervoltage-Lockout Threshold	UVLO	Falling edge of V _{CC} disables ADC	2.30	2.80	2.95	V
Undervoltage-Lockout Hysteresis				90		mV
Power-On Reset (POR) Threshold		V _{CC} falling edge	1.2	2.0	2.5	V
POR Threshold Hysteresis				90		mV
ALERT, OVERT						
Output Low Voltage	V _{OL}	I _{SINK} = 1mA			0.3	V
		I _{SINK} = 6mA			0.5	
Output Leakage Current					1	μA

7-Channel Precision Temperature Monitor

MAX6697

ELECTRICAL CHARACTERISTICS (continued)

($V_{CC} = +3.0V$ to $+5.5V$, $T_A = -40^{\circ}C$ to $+125^{\circ}C$, unless otherwise noted. Typical values are at $V_{CC} = +3.3V$ and $T_A = +25^{\circ}C$.) (Note 1)

PARAMETER	SYMBOL	CONDITIONS	MIN	TYP	MAX	UNITS
SMBus INTERFACE (SCL, SDA)						
Logic-Input Low Voltage	V_{IL}				0.8	V
Logic-Input High Voltage	V_{IH}	$V_{CC} = 3.0V$	2.2			V
		$V_{CC} = 5.0V$	2.4			V
Input Leakage Current			-1		+1	μA
Output Low Voltage	V_{OL}	$I_{SINK} = 6mA$			0.3	V
Input Capacitance	C_{IN}			5		pF
SMBus-COMPATIBLE TIMING (Figures 3 and 4) (Note 2)						
Serial Clock Frequency	f_{SCL}	(Note 3)			400	kHz
Bus Free Time Between STOP and START Condition	t_{BUF}	$f_{SCL} = 100kHz$	4.7			μs
		$f_{SCL} = 400kHz$	1.6			
START Condition Setup Time		$f_{SCL} = 100kHz$	4.7			μs
		$f_{SCL} = 400kHz$	0.6			
Repeat START Condition Setup Time	$t_{SU:STA}$	90% of SCL to 90% of SDA, $f_{SCL} = 100kHz$	0.6			μs
		90% of SCL to 90% of SDA, $f_{SCL} = 400kHz$	0.6			
START Condition Hold Time	$t_{HD:STA}$	10% of SDA to 90% of SCL	0.6			μs
STOP Condition Setup Time	$t_{SU:STO}$	90% of SCL to 90% of SDA, $f_{SCL} = 100kHz$	4			μs
		90% of SCL to 90% of SDA, $f_{SCL} = 400kHz$	0.6			
Clock Low Period	t_{LOW}	10% to 10%, $f_{SCL} = 100kHz$	1.3			μs
		10% to 10%, $f_{SCL} = 400kHz$	1.3			
Clock High Period	t_{HIGH}	90% to 90%	0.6			μs
Data Hold Time	$t_{HD:DAT}$	$f_{SCL} = 100kHz$	300			ns
		$f_{SCL} = 400kHz$ (Note 4)			900	
Data Setup Time	$t_{SU:DAT}$	$f_{SCL} = 100kHz$	250			ns
		$f_{SCL} = 400kHz$	100			
Receive SCL/SDA Rise Time	t_R	$f_{SCL} = 100kHz$			1	μs
		$f_{SCL} = 400kHz$			0.3	
Receive SCL/SDA Fall Time	t_F				300	ns
Pulse Width of Spike Suppressed	t_{SP}		0		50	ns
SMBus Timeout	$t_{TIMEOUT}$	SDA low period for interface reset	25	37	45	ms

Note 1: All parameters are tested at $T_A = +25^{\circ}C$. Specifications over temperature are guaranteed by design.

Note 2: Timing specifications are guaranteed by design.

Note 3: The serial interface resets when SCL is low for more than $t_{TIMEOUT}$.

Note 4: A transition must internally provide at least a hold time to bridge the undefined region (300ns max) of SCL's falling edge.

7-Channel Precision Temperature Monitor

Typical Operating Characteristics

($V_{CC} = 3.3V$, $T_A = +25^\circ C$, unless otherwise noted.)

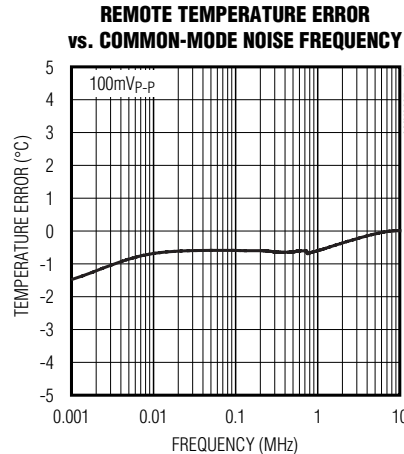
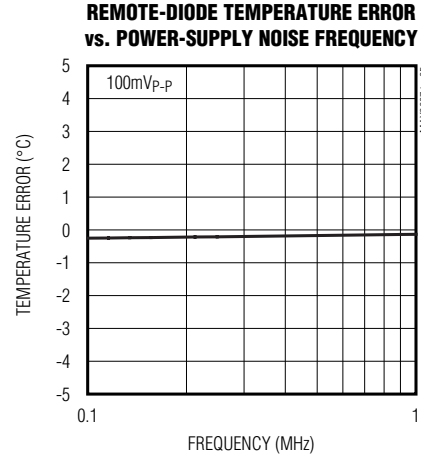
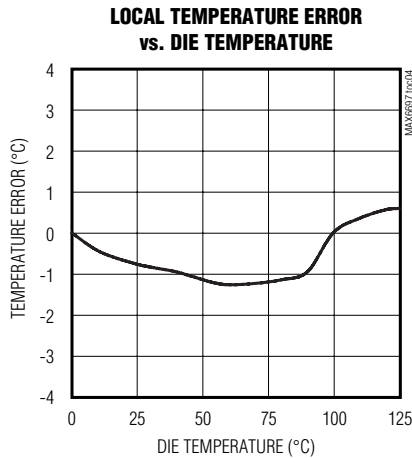
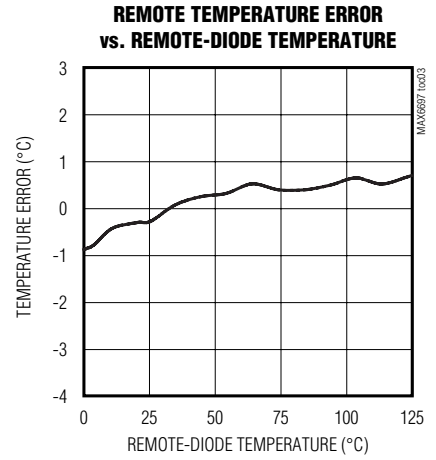
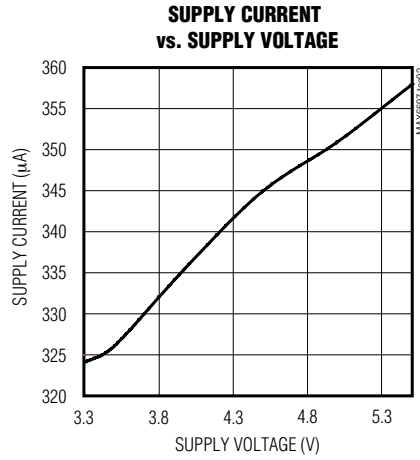

7-Channel Precision Temperature Monitor

Typical Operating Characteristics (continued)

($V_{CC} = 3.3V$, $T_A = +25^\circ C$, unless otherwise noted.)



Pin Description

PIN	NAME	FUNCTION
1	DXP1	Combined Current Source and A/D Positive Input for Channel 1 Remote Diode. Connect to the anode of a remote-diode-connected temperature-sensing transistor. Leave floating or connect to V_{CC} if no remote diode is used. Place a 2200pF capacitor between DXP1 and DXN1 for noise filtering.
2	DXN1	Cathode Input for Channel 1 Remote Diode. Connect the cathode of the channel 1 remote-diode-connected transistor to DXN1.
3	DXP2	Combined Current Source and A/D Positive Input for Channel 2 Remote Diode. Connect to the anode of a remote-diode-connected temperature-sensing transistor. Leave floating or connect to V_{CC} if no remote diode is used. Place a 2200pF capacitor between DXP2 and DXN2 for noise filtering.
4	DXN2	Cathode Input for Channel 2 Remote Diode. Connect the cathode of the channel 2 remote-diode-connected transistor to DXN2.
5	DXP3	Combined Current Source and A/D Positive Input for Channel 3 Remote Diode. Connect to the anode of a remote-diode-connected temperature-sensing transistor. Leave floating or connect to V_{CC} if no remote diode is used. Place a 2200pF capacitor between DXP3 and DXN3 for noise filtering.
6	DXN3	Cathode Input for Channel 3 Remote Diode. Connect the cathode of the channel 1 remote-diode-connected transistor to DXN3.
7	DXP4	Combined Current Source and A/D Positive Input for Channel 4 Remote Diode. Connect to the anode of a remote-diode-connected temperature-sensing transistor. Leave floating or connect to V_{CC} if no remote diode is used. Place a 2200pF capacitor between DXP4 and DXN4 for noise filtering.
8	DXN4	Cathode Input for Channel 4 Remote Diode. Connect the cathode of the channel 1 remote-diode-connected transistor to DXN4.

7-Channel Precision Temperature Monitor

Pin Description (continued)

PIN	NAME	FUNCTION
9	DXP5	Combined Current Source and A/D Positive Input for Channel 5 Remote Diode. Connect to the anode of a remote-diode-connected temperature-sensing transistor. Leave floating or connect to V _{CC} if no remote diode is used. Place a 2200pF capacitor between DXP5 and DXN5 for noise filtering.
10	DXN5	Cathode Input for Channel 5 Remote Diode. Connect the cathode of the channel 1 remote-diode-connected transistor to DXN5.
11	DXN6	Cathode Input for Channel 6 Remote Diode. Connect the cathode of the channel 1 remote-diode-connected transistor to DXN6.
12	DXP6	Combined Current Source and A/D Positive Input for Channel 6 Remote Diode. Connect to the anode of a remote-diode-connected temperature-sensing transistor. Leave floating or connect to V _{CC} if no remote diode is used. Place a 2200pF capacitor between DXP6 and DXN6 for noise filtering.
13, 14	NC_	No Connect. Must be connected to ground.
15	$\overline{\text{OVERT}}$	Overtemperature Active-Low, Open-Drain Output. $\overline{\text{OVERT}}$ asserts low when the temperature of channels 1, 4, 5, and 6 exceeds the programmed threshold limit.
16	V _{CC}	Supply Voltage Input. Bypass to GND with a 0.1μF capacitor.
17	$\overline{\text{ALERT}}$	SMBus Alert (Interrupt), Active-Low, Open-Drain Output. $\overline{\text{ALERT}}$ asserts low when the temperature of any channel exceeds the programmed $\overline{\text{ALERT}}$ threshold.
18	SMBDATA	SMBus Serial-Data Input/Output. Connect to a pullup resistor.
19	SMBCLK	SMBus Serial-Clock Input. Connect to a pullup resistor.
20	GND	Ground

Detailed Description

The MAX6697 is a precision multichannel temperature monitor that features one local and six remote temperature-sensing channels with a programmable alert threshold for each temperature channel and a programmable overtemperature threshold for channels 1, 4, 5, and 6 (see Figure 1). Communication with the MAX6697 is achieved through the SMBus serial interface and a dedicated alert pin. The alarm outputs, $\overline{\text{OVERT}}$ and $\overline{\text{ALERT}}$, assert if the software-programmed temperature thresholds are exceeded. $\overline{\text{ALERT}}$ typically serves as an interrupt, while $\overline{\text{OVERT}}$ can be connected to a fan, system shutdown, or other thermal-management circuitry.

ADC Conversion Sequence

In the default conversion mode, the MAX6697 starts the conversion sequence by measuring the temperature on channel 1, followed by 2, 3, local channel, 4, 5, and 6. The conversion result for each active channel is stored in the corresponding temperature data register.

In some systems, one of the remote thermal diodes may be monitoring a location that experiences temperature changes that occur much more rapidly than in the other

channels. If faster temperature changes must be monitored in one of the temperature channels, the MAX6697 allows channel 1 to be monitored at a faster rate than the other channels. In this mode (set by writing a 1 to bit 4 of the configuration 1 register), measurements of channel 1 alternate with measurements of the other channels. The sequence becomes channel 1, channel 2, channel 1, channel 3, channel 1, etc. Note that the time required to measure all seven channels is considerably greater in this mode than in the default mode.

Low-Power Standby Mode

Standby mode reduces the supply current to less than 15μA by disabling the internal ADC. Enter standby by setting the STOP bit to 1 in the configuration 1 register. During standby, data is retained in memory, and the SMBus interface is active and listening for SMBus commands. The timeout is enabled if a start condition is recognized on SMBus. Activity on the SMBus causes the supply current to increase. If a standby command is received while a conversion is in progress, the conversion cycle is interrupted, and the temperature registers are not updated. The previous data is not changed and remains available.

7-Channel Precision Temperature Monitor

MAX6697



Figure 1. Internal Block Diagram

SMBus Digital Interface

From a software perspective, the MAX6697 appears as a series of 8-bit registers that contain temperature measurement data, alarm threshold values, and control bits. A standard SMBus-compatible 2-wire serial interface is used to read temperature data and write control bits and alarm threshold data. The same SMBus slave address also provides access to all functions.

The MAX6697 employs four standard SMBus protocols: write byte, read byte, send byte, and receive byte (Figure 2). The shorter receive byte protocol allows quicker transfers, provided that the correct data register was previously selected by a read byte instruction. Use caution with the shorter protocols in multimaster

systems, since a second master could overwrite the command byte without informing the first master. Figure 3 is the SMBus write timing diagram and Figure 4 is the SMBus read timing diagram.

The remote diode 1 measurement channel provides 11 bits of data (1 LSB = 0.125°C). All other temperature-measurement channels provide 8 bits of temperature data (1 LSB = 1°C). The 8 most significant bits (MSBs) can be read from the local temperature and remote temperature registers. The remaining 3 bits for remote diode 1 can be read from the extended temperature register. If extended resolution is desired, the extended resolution register should be read first. This prevents the most significant bits from being overwritten by new

7-Channel Precision Temperature Monitor

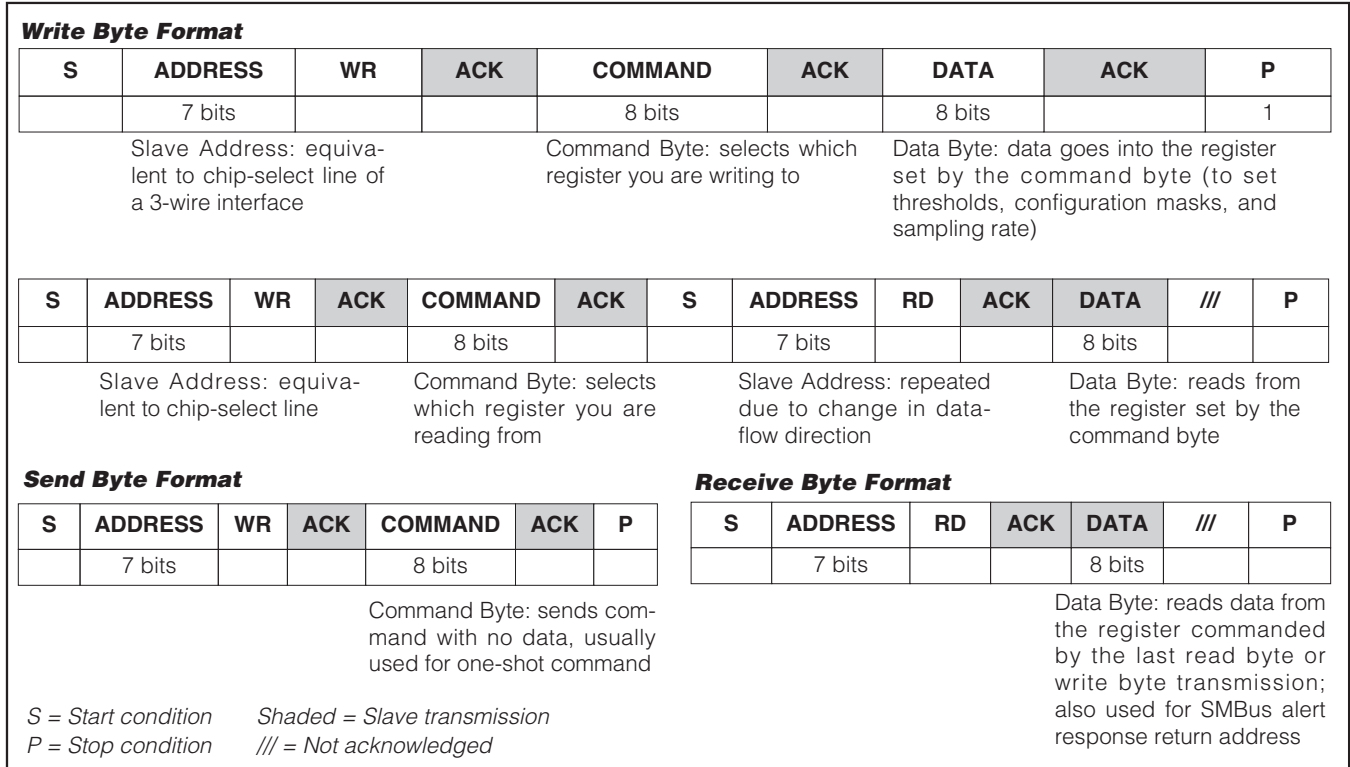

Figure 2. SMBus Protocols

Table 1. Main Temperature Register (High Byte) Data Format

TEMP (°C)	DIGITAL OUTPUT
>127	0111 1111
127	0111 1111
126	0111 1110
25	0001 1001
0.00	0000 0000
<0.00	0000 0000
Diode fault (open)	1111 1111
Diode fault (short)	1111 1111 or 1110 1110

conversion results until they have been read. If the most significant bits have not been read within an SMBus timeout period (nominally 37ms), normal updating continues. Table 1 shows the main temperature register (high byte) data format, and Table 2 shows the extended resolution register (low byte) data format.

Table 2. Extended Resolution Temperature Register (Low Byte) Data Format

TEMP (°C)	DIGITAL OUTPUT
0	000X XXXX
+0.125	001X XXXX
+0.250	010X XXXX
+0.375	011X XXXX
+0.500	100X XXXX
+0.625	101X XXXX
+0.725	110X XXXX
+0.875	111X XXXX

Diode Fault Detection

If a channel's input DXP_ and DXN_ are left open, the MAX6697 detects a diode fault. An open diode fault does not cause either ALERT or OVERT to assert. A bit in the status register for the corresponding channel is set to 1 and the temperature data for the channel is stored as all 1s (FFh). It takes approximately 4ms for the MAX6697 to detect a diode fault. Once a diode fault is detected, the MAX6697 goes to the next channel in

7-Channel Precision Temperature Monitor



Figure 3. SMBus Write Timing Diagram



Figure 4. SMBus Read Timing Diagram

the conversion sequence. Depending on operating conditions, a shorted diode may or may not cause \overline{ALERT} or \overline{OVERT} to assert, so if a channel will not be used, disconnect its DXP and DXN inputs.

Alarm Threshold Registers

There are 11 alarm threshold registers that store over-temperature \overline{ALERT} and \overline{OVERT} threshold values. Seven of these registers are dedicated to store one local alert temperature threshold limit and six remote alert temperature threshold limits (see the *ALERT Interrupt Mode* section). The remaining four registers are dedicated to remote channels 1, 4, 5, and 6 to store overtemperature threshold limits (see the *OVERT*

Overtemperature Alarm section). Access to these registers is provided through the SMBus interface.

ALERT Interrupt Mode

An \overline{ALERT} interrupt occurs when the internal or external temperature reading exceeds a high-temperature limit (user programmable). The \overline{ALERT} interrupt output signal can be cleared by reading the status register(s) associated with the fault(s) or by successfully responding to an alert response address transmission by the master. In both cases, the alert is cleared but is reasserted at the end of the next conversion if the fault condition still exists. The interrupt does not halt automatic conversions. The \overline{ALERT} output is open drain so that multiple devices

7-Channel Precision Temperature Monitor

can share a common interrupt line. All $\overline{\text{ALERT}}$ interrupts can be masked using the configuration 3 register. The POR state of these registers is shown in Table 1.

$\overline{\text{ALERT}}$ Response Address

The SMBus alert response interrupt pointer provides quick fault identification for simple slave devices that lack the complex logic needed to be a bus master. Upon receiving an interrupt signal, the host master can broadcast a receive byte transmission to the alert response slave address (see the *Slave Addresses* section). Then, any slave device that generated an interrupt attempts to identify itself by putting its own address on the bus.

The alert response can activate several different slave devices simultaneously, similar to the I²C General Call. If more than one slave attempts to respond, bus arbitration rules apply, and the device with the lower address code wins. The losing device does not generate an acknowledgment and continues to hold the $\overline{\text{ALERT}}$ line low until cleared. (The conditions for clearing an alert vary depending on the type of slave device.) Successful completion of the alert response protocol clears the output latch. If the condition that caused the alert still exists, the MAX6697 reasserts the $\overline{\text{ALERT}}$ interrupt at the end of the next conversion.

$\overline{\text{OVERT}}$ Overtemperature Alarms

The MAX6697 has four overtemperature registers that store remote alarm threshold data for the $\overline{\text{OVERT}}$ output. $\overline{\text{OVERT}}$ is asserted when a channel's measured temperature is greater than the value stored in the corresponding threshold register. $\overline{\text{OVERT}}$ remains asserted until the temperature drops below the programmed threshold minus 4°C hysteresis. An overtemperature output can be used to activate a cooling fan, send a warning, initiate clock throttling, or trigger a system shutdown to prevent component damage. See Table 3 for the POR state of the overtemperature threshold registers.

Command Byte Functions

The 8-bit command byte register (Table 3) is the master index that points to the various other registers within the MAX6697. This register's POR state is 0000 0000.

Configuration Bytes Functions

There are three read-write configuration registers (Tables 4, 5, and 6) that can be used to control the MAX6697's operation.

Configuration 1 Register

The configuration 1 register (Table 4) has several functions. Bit 7(MSB) is used to put the MAX6697 either in software standby mode (STOP) or continuous conversion mode. Bit 6 resets all registers to their power-on reset conditions and then clears itself. Bit 5 disables the SMBus timeout. Bit 4 enables more frequent conversions on channel 1, as described in the *ADC Conversion Sequence* section. Bit 3 enables resistance cancellation on channel 1. See the *Series Resistance Cancellation* section for more details. The remaining bits of the configuration 1 register are not used. The POR state of this register is 0000 0000 (00h).

Configuration 2 Register

The configuration 2 register functions are described in Table 5. Bits [6:0] are used to mask the $\overline{\text{ALERT}}$ interrupt output. Bit 6 masks the local alert interrupt and bits 5 through bit 0 mask the remote alert interrupts. The power-up state of this register is 0000 0000 (00h).

Configuration 3 Register

Table 6 describes the configuration 3 register. Bits 5, 4, 3, and 0 mask the $\overline{\text{OVERT}}$ interrupt output for channels 6, 5, 4, and 1. The remaining bits, 7, 6, 2, and 1, are reserved. The power-up state of this register is 0000 0000 (00h).

Status Registers Functions

Status registers 1, 2, and 3 (Tables 7, 8, and 9) indicate which (if any) temperature thresholds have been exceeded and if there is an open-circuit or short-circuit fault detected with the external sense junctions. Status register 1 indicates if the measured temperature has exceeded the threshold limit set in the $\overline{\text{ALERT}}$ registers for the local or remote-sensing diodes. Status register 2 indicates if the measured temperature has exceeded the threshold limit set in the $\overline{\text{OVERT}}$ registers. Status register 3 indicates if there is a diode fault (open or short) in any of the remote-sensing channels.

Bits in the alert status register clear by a successful read, but set again after the next conversion unless the fault is corrected, either by a drop in the measured temperature or an increase in the threshold temperature.

The $\overline{\text{ALERT}}$ interrupt output follows the status flag bit. Once the $\overline{\text{ALERT}}$ output is asserted, it can be deasserted by either reading status register 1 or by successfully responding to an alert response address. In both

7-Channel Precision Temperature Monitor

MAX6697

Table 3. Command Byte Register Bit Assignment

REGISTER	ADDRESS (HEX)	POR STATE (HEX)	READ/ WRITE	DESCRIPTION
Local	07	00	R	Read local temperature register
Remote 1	01	00	R	Read channel 1 remote temperature register
Remote 2	02	00	R	Read channel 2 remote temperature register
Remote 3	03	00	R	Read channel 3 remote temperature register
Remote 4	04	00	R	Read channel 4 remote temperature register
Remote 5	05	00	R	Read channel 5 remote temperature register
Remote 6	06	00	R	Read channel 6 remote temperature register
Configuration 1	41	00	R/W	Read/write configuration register 1
Configuration 2	42	00	R/W	Read/write configuration register 2
Configuration 3	43	00	R/W	Read/write configuration register 3
Status1	44	00	R	Read status register 1
Status2	45	00	R	Read status register 2
Status3	46	00	R	Read status register 3
Local $\overline{\text{ALERT}}$ High Limit	17	5A	R/W	Read/write local alert high-temperature threshold limit register
Remote 1 $\overline{\text{ALERT}}$ High Limit	11	6E	R/W	Read/write channel 1 remote-diode alert high-temperature threshold limit register
Remote 2 $\overline{\text{ALERT}}$ High Limit	12	7F	R/W	Read/write channel 2 remote-diode alert high-temperature threshold limit register
Remote 3 $\overline{\text{ALERT}}$ High Limit	13	64	R/W	Read/write channel 3 remote-diode alert high-temperature threshold limit register
Remote 4 $\overline{\text{ALERT}}$ High Limit	14	64	R/W	Read/write channel 4 remote-diode alert high-temperature threshold limit register
Remote 5 $\overline{\text{ALERT}}$ High Limit	15	64	R/W	Read/write channel 5 remote-diode alert high-temperature threshold limit register
Remote 6 $\overline{\text{ALERT}}$ High Limit	16	64	R/W	Read/write channel 6 remote-diode alert high-temperature threshold limit register
Remote 1 $\overline{\text{OVERT}}$ High Limit	21	6E	R/W	Read/write channel 1 remote-diode overtemperature threshold limit register
Remote 4 $\overline{\text{OVERT}}$ High Limit	24	7F	R/W	Read/write channel 4 remote-diode overtemperature threshold limit register
Remote 5 $\overline{\text{OVERT}}$ High Limit	25	5A	R/W	Read/write channel 5 remote-diode overtemperature threshold limit register
Remote 6 $\overline{\text{OVERT}}$ High Limit	26	5A	R/W	Read/write channel 6 remote-diode overtemperature threshold limit register
Remote 1 Extended Temperature	09	00	R	Read channel 1 remote-diode extended temperature register
Manufacturer ID	0A	4D	R	Read manufacturer ID

7-Channel Precision Temperature Monitor

Table 4. Configuration 1 Register

BIT	NAME	POR STATE	FUNCTION
7(MSB)	STOP	0	Standby Mode Control Bit. If STOP is set to logic 1, the MAX6697 stops converting and enters standby mode.
6	POR	0	Reset Bit. Set to logic 1 to put the device into its power-on state. This bit is self-clearing.
5	$\overline{\text{TIMEOUT}}$	0	Timeout Enable Bit. Set to logic 0 to enable SMBus timeout.
4	Fast remote 1	0	Channel 1 Fast Conversion Bit. Set to logic 1 to enable fast conversion of channel 1.
3	Resistance cancellation	0	Resistance Cancellation Bit. When set to logic 1, the MAX6697 cancels series resistance in the channel 1 thermal diode.
2	Reserved	0	—
1	Reserved	0	—
0	Reserved	0	—

Table 5. Configuration 2 Register

BIT	NAME	POR STATE	FUNCTION
7(MSB)	Reserved	0	
6	Mask Local ALERT	0	Local Alert Mask. Set to logic 1 to mask local channel $\overline{\text{ALERT}}$.
5	Mask ALERT 6	0	Channel 6 Alert Mask. Set to logic 1 to mask channel 6 $\overline{\text{ALERT}}$.
4	Mask ALERT 5	0	Channel 5 Alert Interrupt Mask. Set to logic 1 to mask channel 5 $\overline{\text{ALERT}}$.
3	Mask ALERT 4	0	Channel 4 Alert Mask. Set to logic 1 to mask channel 4 $\overline{\text{ALERT}}$.
2	Mask ALERT 3	0	Channel 3 Alert Interrupt Mask. Set to logic 1 to mask channel 3 $\overline{\text{ALERT}}$.
1	Mask ALERT 2	0	Channel 2 Alert Mask. Set to logic 1 to mask channel 2 $\overline{\text{ALERT}}$.
0	Mask ALERT 1	0	Channel 1 Alert Mask. Set to logic 1 to mask channel 1 $\overline{\text{ALERT}}$.

cases, the alert is cleared even if the fault condition exists, but the $\overline{\text{ALERT}}$ output reasserts at the end of the next conversion. The bits indicating the fault for the $\overline{\text{OVERT}}$ interrupt output clear only on reading the status 2 register even if the fault conditions still exist. Reading the status 2 register does not clear the $\overline{\text{OVERT}}$ interrupt output. To eliminate the fault condition, either the measured temperature must drop below the temperature threshold minus the hysteresis value (4°C), or the trip temperature must be set at least 4°C above the current temperature.

Applications Information

Remote-Diode Selection

The MAX6697 directly measures the die temperature of CPUs and other ICs that have on-chip temperature-

sensing diodes (see the *Typical Application Circuit*) or it can measure the temperature of a discrete diode-connected transistor.

Effect of Ideality Factor

The accuracy of the remote temperature measurements depends on the ideality factor (n) of the remote “diode” (actually a transistor). The MAX6697 is optimized for $n = 1.008$. A thermal diode on the substrate of an IC is normally a pnp with the base and emitter brought out the collector (diode connection) grounded. DXP_ must be connected to the anode (emitter) and DXN_ must be connected to the cathode (base) of this pnp. If a sense transistor with an ideality factor other than 1.008 is used, the output data is different from the data obtained with the optimum ideality factor. Fortunately, the difference is predictable. Assume a

7-Channel Precision Temperature Monitor

Table 6. Configuration 3 Register

BIT	NAME	POR STATE	FUNCTION
7(MSB)	Reserved	0	—
6	Reserved	0	—
5	Mask OVERT 6	0	Channel 6 Remote-Diode $\overline{\text{OVERT}}$ Mask Bit. Set to logic 1 to mask channel 6 $\overline{\text{OVERT}}$.
4	Mask OVERT 5	0	Channel 5 Remote-Diode $\overline{\text{OVERT}}$ Mask Bit. Set to logic 1 to mask channel 5 $\overline{\text{OVERT}}$.
3	Mask OVERT 4	0	Channel 4 Remote-Diode $\overline{\text{OVERT}}$ Mask Bit. Set to logic 1 to mask channel 4 $\overline{\text{OVERT}}$.
2	Reserved	0	—
1	Reserved	0	—
0	Mask OVERT 1	0	Channel 1 Remote-Diode $\overline{\text{OVERT}}$ Mask Bit. Set to logic 1 to mask channel 1 $\overline{\text{OVERT}}$.

remote-diode sensor designed for a nominal ideality factor n_{NOMINAL} is used to measure the temperature of a diode with a different ideality factor n_1 . The measured temperature T_M can be corrected using:

$$T_M = T_{\text{ACTUAL}} \left(\frac{n_1}{n_{\text{NOMINAL}}} \right)$$

where temperature is measured in Kelvin and n_{NOMINAL} for the MAX6697 is 1.008. As an example, assume you want to use the MAX6697 with a CPU that has an ideality factor of 1.002. If the diode has no series resistance, the measured data is related to the real temperature as follows:

$$T_{\text{ACTUAL}} = T_M \times \left(\frac{n_{\text{NOMINAL}}}{n_1} \right) = T_M \times \left(\frac{1.008}{1.002} \right) = T_M(1.00599)$$

For a real temperature of +85°C (358.15K), the measured temperature is +82.87°C (356.02K), an error of -2.13°C.

Series Resistance Cancellation

Some thermal diodes on high-power ICs can have excessive series resistance, which can cause temperature measurement errors with conventional remote temperature sensors. Channel 1 of the MAX6697 has a series resistance cancellation feature (enabled by bit 3 of the configuration 1 register) that eliminates the effect of diode series resistance. Set bit 3 to 1 if the series resistance is large enough to affect the accuracy of channel 1. The series resistance cancellation function

increases the conversion time for channel 1 by 125ms. This feature cancels the bulk resistance of the sensor and any other resistance in series (wire, contact resistance, etc.). The cancellation range is from 0 to 100Ω.

Discrete Remote Diodes

When the remote-sensing diode is a discrete transistor, its collector and base must be connected together. Table 10 lists examples of discrete transistors that are appropriate for use with the MAX6697. The transistor must be a small-signal type with a relatively high forward voltage; otherwise, the A/D input voltage range can be violated. The forward voltage at the highest expected temperature must be greater than 0.25V at 10μA, and at the lowest expected temperature, the forward voltage must be less than 0.95V at 100μA. Large power transistors must not be used. Also, ensure that the base resistance is less than 100Ω. Tight specifications for forward current gain ($50 < \beta < 150$, for example) indicate that the manufacturer has good process controls and that the devices have consistent V_{BE} characteristics. Manufacturers of discrete transistors do not normally specify or guarantee ideality factor. This is normally not a problem since good-quality discrete transistors tend to have ideality factors that fall within a relatively narrow range. We have observed variations in remote temperature readings of less than ±2°C with a variety of discrete transistors. Still, it is good design practice to verify good consistency of temperature readings with several discrete transistors from any manufacturer under consideration.

7-Channel Precision Temperature Monitor

Table 7. Status 1 Register

BIT	NAME	POR STATE	FUNCTION
7(MSB)	Reserved	0	—
6	Local ALERT	0	Local Channel High-Alert Bit. This bit is set to logic 1 when the local temperature exceeds the temperature threshold limit in the local ALERT high-limit register.
5	Remote 6 ALERT	0	Channel 6 Remote-Diode High-Alert Bit. This bit is set to logic 1 when the channel 6 remote-diode temperature exceeds the temperature threshold limit in the remote 6 ALERT high-limit register.
4	Remote 5 ALERT	0	Channel 5 Remote-Diode High-Alert Bit. This bit is set to logic 1 when the channel 5 remote-diode temperature exceeds the programmed temperature threshold limit in the remote 5 ALERT high-limit register.
3	Remote 4 ALERT	0	Channel 4 Remote-Diode High-Alert Bit. This bit is set to logic 1 when the channel 4 remote-diode temperature exceeds the temperature threshold limit in the remote 4 ALERT high-limit register.
2	Remote 3 ALERT	0	Channel 3 Remote-Diode High-Alert Bit. This bit is set to logic 1 when the channel 3 remote-diode temperature exceeds the programmed temperature threshold limit in the remote 3 ALERT high-limit register.
1	Remote 2 ALERT	0	Channel 2 Remote-Diode High-Alert Bit. This bit is set to logic 1 when the channel 2 remote-diode temperature exceeds the temperature threshold limit in the remote 2 ALERT high-limit register.
0	Remote 1 ALERT	0	Channel 1 Remote-Diode High-Alert Bit. This bit is set to logic 1 when the channel 1 remote-diode temperature exceeds the temperature threshold limit in the remote 1 ALERT high-limit register.

Unused Diode Channels

If one or more of the remote diode channels is not needed, the DXP and DXN inputs for that channel should either be unconnected, or the DXP input should be connected to V_{CC}. The status register indicates a diode "fault" for this channel and the channel is ignored during the temperature-measurement sequence. It is also good practice to mask any unused channels immediately upon power-up by setting the appropriate bits in the Configuration 2 and Configuration 3 registers. This will prevent unused channels from causing ALERT# or OVERT# to assert.

Thermal Mass and Self-Heating

When sensing local temperature, the MAX6697 measures the temperature of the printed-circuit board (PCB) to which it is soldered. The leads provide a good thermal path between the PCB traces and the die. As with all IC temperature sensors, thermal conductivity between the die and the ambient air is poor by compar-

ison, making air temperature measurements impractical. Because the thermal mass of the PCB is far greater than that of the MAX6697, the device follows temperature changes on the PCB with little or no perceivable delay. When measuring the temperature of a CPU or other IC with an on-chip sense junction, thermal mass has virtually no effect; the measured temperature of the junction tracks the actual temperature within a conversion cycle.

When measuring temperature with discrete remote transistors, the best thermal response times are obtained with transistors in small packages (i.e., SOT23 or SC70). Take care to account for thermal gradients between the heat source and the sensor, and ensure that stray air currents across the sensor package do not interfere with measurement accuracy. Self-heating does not significantly affect measurement accuracy. Remote-sensor self-heating due to the diode current source is negligible.

7-Channel Precision Temperature Monitor

MAX6697

Table 8. Status 2 Register

BIT	NAME	POR STATE	FUNCTION
7(MSB)	Reserved	0	—
6	Reserved	0	—
5	Remote 6 OVERT	0	Channel 6 Remote-Diode Overtemperature Status Bit. This bit is set to logic 1 when the channel 6 remote-diode temperature exceeds the temperature threshold limit in the remote 6 OVERT high-limit register.
4	Remote 5 OVERT	0	Channel 5 Remote Diode Overtemperature Status Bit. This bit is set to logic 1 when the channel 5 remote-diode temperature exceeds the temperature threshold limit in the remote 5 OVERT high-limit register.
3	Remote 4 OVERT	0	Channel 4 Remote Diode Overtemperature Status Bit. This bit is set to logic 1 when the channel 4 remote-diode temperature exceeds the temperature threshold limit in the remote 4 OVERT high-limit register.
2	Reserved	0	—
1	Reserved	0	—
0	Remote 1 OVERT	0	Channel 1 Remote-Diode Overtemperature Status Bit. This bit is set to logic 1 when the channel 1 remote-diode temperature exceeds the temperature threshold limit in the remote 1 OVERT high-limit register.

Table 9. Status 3 Register

BIT	NAME	POR STATE	FUNCTION
7(MSB)	Reserved	0	—
6	Diode fault 6	0	Channel 6 Remote-Diode Fault Bit. This bit is set to 1 when DXP6 and DXN6 are open circuit or when DXP6 is connected to VCC.
5	Diode fault 5	0	Channel 5 Remote-Diode Fault Bit. This bit is set to 1 when DXP5 and DXN5 are open circuit or when DXP5 is connected to VCC.
4	Diode fault 4	0	Channel 4 Remote-Diode Fault Bit. This bit is set to 1 when DXP4 and DXN4 are open circuit or when DXP4 is connected to VCC.
3	Diode fault 3	0	Channel 3 Remote-Diode Fault Bit. This bit is set to 1 when DXP3 and DXN3 are open circuit or when DXP3 is connected to VCC.
2	Diode fault 2	0	Channel 2 Remote-Diode Fault Bit. This bit is set to 1 when DXP2 and DXN2 are open circuit or when DXP2 is connected to VCC.
1	Diode fault 1	0	Channel 1 Remote-Diode Fault Bit. This bit is set to 1 when DXP1 and DXN1 are open circuit or when DXP1 is connected to VCC.
0	Reserved	0	—

7-Channel Precision Temperature Monitor

Table 10. Remote-Sensors Transistor Manufacturer

MANUFACTURER	MODEL NO.
Central Semiconductor (USA)	CMPT3904
Rohm Semiconductor (USA)	SST3904
Samsung (Korea)	KST3904-TF
Siemens (Germany)	SMBT3904
Zetex (England)	FMMT3904CT-ND

Note: Discrete transistors must be diode connected (base shorted to collector).

Slave Address

Table 11 shows the MAX6697 slave addresses.

Table 11. Slave Address

PART	SMBus SLAVE ID	PIN-PACKAGE
MAX6697EP34	0011 010	20 QSOP
MAX6697EP38	0011 100	20 QSOP
MAX6697EP99	1001 100	20 QSOP
MAX6697EP9C	1001 110	20 QSOP
MAX6697UP34	0011 010	20 TSSOP
MAX6697UP38	0011 100	20 TSSOP
MAX6697UP99	1001 100	20 TSSOP
MAX6697UP9C	1001 110	20 TSSOP

ADC Noise Filtering

The integrating ADC has good noise rejection for low-frequency signals such as power-supply hum. In environments with significant high-frequency EMI, connect an external 2200pF capacitor between DXP_ and DXN_. Larger capacitor values can be used for added filtering, but do not exceed 3300pF because it can introduce errors due to the rise time of the switched current source. High-frequency noise reduction is needed for high-accuracy remote measurements. Noise can be reduced with careful PCB layout as discussed in the *PCB Layout* section.

PCB Layout

Follow these guidelines to reduce the measurement error when measuring remote temperature:

- 1) Place the MAX6697 as close as is practical to the remote diode. In noisy environments, such as a computer motherboard, this distance can be 4in to 8in (typ). This length can be increased if the worst noise sources are avoided. Noise sources include CRTs, clock generators, memory buses, and PCI buses.
- 2) Do not route the DXP-DXN lines next to the deflection coils of a CRT. Also, do not route the traces across fast digital signals, which can easily introduce +30°C error, even with good filtering.
- 3) Route the DXP and DXN traces in parallel and in close proximity to each other. Each parallel pair of traces should go to a remote diode. Route these traces away from any higher voltage traces, such as +12VDC. Leakage currents from PCB contamination must be dealt with carefully since a 20MΩ leakage path from DXP to ground causes about +1°C error. If high-voltage traces are unavoidable, connect guard traces to GND on either side of the DXP-DXN traces (Figure 5).
- 4) Route through as few vias and crossunders as possible to minimize copper/solder thermocouple effects.
- 5) Use wide traces when practical.
- 6) When the power supply is noisy, add a resistor (up to 47Ω) in series with VCC.

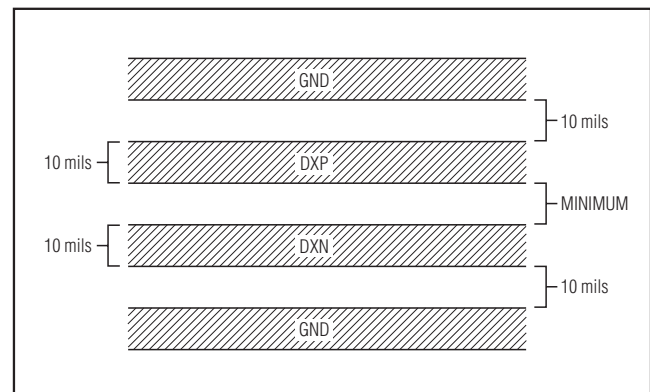

Figure 5. Recommended DXP-DXN PCB Traces

7-Channel Precision Temperature Monitor

Twisted-Pair and Shielded Cables

Use a twisted-pair cable to connect the remote sensor for remote-sensor distances longer than 8in or in very noisy environments. Twisted-pair cable lengths can be between 6ft and 12ft before noise introduces excessive errors. For longer distances, the best solution is a shielded twisted pair like that used for audio microphones. For example, Belden #8451 works well for distances up to 100ft in a noisy environment. At the device, connect the twisted pair to DXP and DXN and the shield to GND. Leave the shield unconnected at the remote sensor. For very long cable runs, the cable's parasitic capacitance often provides noise filtering, so the 2200pF capacitor can often be removed or reduced in value. Cable resistance also affects remote-sensor accuracy. For every 1Ω of series resistance the error is approximately $+1/2^{\circ}\text{C}$.

Pin Configuration



MAX6697

Chip Information

PROCESS: BiCMOS

Package Information

For the latest package outline information and land patterns, go to www.maxim-ic.com/packages. Note that a "+", "#", or "-" in the package code indicates RoHS status only. Package drawings may show a different suffix character, but the drawing pertains to the package regardless of RoHS status.

PACKAGE TYPE	PACKAGE CODE	DOCUMENT NO.
20 QSOP	E20-1	21-0055
20 TSSOP	U20-2	21-0066

7-Channel Precision Temperature Monitor

MAX6697

MAX6697

Revision History

REVISION NUMBER	REVISION DATE	DESCRIPTION	PAGES CHANGED
3	5/09	Corrected remote sensor connections in <i>Typical Application Circuit</i>	1

Maxim cannot assume responsibility for use of any circuitry other than circuitry entirely embodied in a Maxim product. No circuit patent licenses are implied. Maxim reserves the right to change the circuitry and specifications without notice at any time.

18 **Maxim Integrated Products, 120 San Gabriel Drive, Sunnyvale, CA 94086 408-737-7600**

Компания «Океан Электроники» предлагает заключение долгосрочных отношений при поставках импортных электронных компонентов на взаимовыгодных условиях!

Наши преимущества:

- Поставка оригинальных импортных электронных компонентов напрямую с производств Америки, Европы и Азии, а так же с крупнейших складов мира;
- Широкая линейка поставок активных и пассивных импортных электронных компонентов (более 30 млн. наименований);
- Поставка сложных, дефицитных, либо снятых с производства позиций;
- Оперативные сроки поставки под заказ (от 5 рабочих дней);
- Экспресс доставка в любую точку России;
- Помощь Конструкторского Отдела и консультации квалифицированных инженеров;
- Техническая поддержка проекта, помощь в подборе аналогов, поставка прототипов;
- Поставка электронных компонентов под контролем ВП;
- Система менеджмента качества сертифицирована по Международному стандарту ISO 9001;
- При необходимости вся продукция военного и аэрокосмического назначения проходит испытания и сертификацию в лаборатории (по согласованию с заказчиком);
- Поставка специализированных компонентов военного и аэрокосмического уровня качества (Xilinx, Altera, Analog Devices, Intersil, Interpoint, Microsemi, Actel, Aeroflex, Peregrine, VPT, Syfer, Eurofarad, Texas Instruments, MS Kennedy, Miteq, Cobham, E2V, MA-COM, Hittite, Mini-Circuits, General Dynamics и др.);

Компания «Океан Электроники» является официальным дистрибьютором и эксклюзивным представителем в России одного из крупнейших производителей разъемов военного и аэрокосмического назначения «JONHON», а так же официальным дистрибьютором и эксклюзивным представителем в России производителя высокотехнологичных и надежных решений для передачи СВЧ сигналов «FORSTAR».



JONHON

«JONHON» (основан в 1970 г.)

Разъемы специального, военного и аэрокосмического назначения:

(Применяются в военной, авиационной, аэрокосмической, морской, железнодорожной, горно- и нефтедобывающей отраслях промышленности)

«FORSTAR» (основан в 1998 г.)

ВЧ соединители, коаксиальные кабели, кабельные сборки и микроволновые компоненты:

(Применяются в телекоммуникациях гражданского и специального назначения, в средствах связи, РЛС, а так же военной, авиационной и аэрокосмической отраслях промышленности).



Телефон: 8 (812) 309-75-97 (многоканальный)

Факс: 8 (812) 320-03-32

Электронная почта: ocean@oceanchips.ru

Web: <http://oceanchips.ru/>

Адрес: 198099, г. Санкт-Петербург, ул. Калинина, д. 2, корп. 4, лит. А