



FEATURES

- ♦ Full Load Efficiency up to 91.5% @220VAC
- ♦ Metal Case Box Type Package
- ♦ Package Dimension:
110.8x50.8x13.7mm (4.33"x2.00"x0.54")
- ♦ Operating Baseplate Temperature Range - 40°C to +100°C
- ♦ Input Brown-Out, Output OCP, OTP, OVP, SHORT protection
- ♦ 3000VAC Isolation
- ♦ RoHS Compliant
- ♦ CE Mark
- ♦ EMC compatible: CISPR11 ClassB (with external EMC filter)
- ♦ ISO 9001, ISO 14001 certified manufacturing facility
- ♦ UL/cUL 60950-1 (US & Canada)
- ♦ Surge immunity(with external EMC filter):
AC: ±1 kV differential mode
AC: ±2 kV common mode

The PACSR12025, a wide input voltage range of 85~265VAC, and single isolated output converter, is the latest product offering from a world leader in power systems technology and manufacturing — Delta Electronics, Inc. Such module type ACDC converter can provide 300W, 12V regulated DC output voltage with full load efficiency up to 91.5% @220VAC; the PACSR12025 offers Brown-out, output OCP, OTP, OVP and Short protections, and allows a wide operating baseplate temperature range of -40°C to +100°C. With creative design technology and optimization of component placement, this converter possess outstanding electrical and thermal performance, as well as high reliability under extremely harsh operating conditions.

(All specifications valid base on the connection of figure 10, unless otherwise indicated)

INPUT CHARACTERISTICS

Item	Condition	Min.	Typ.	Max.	Unit
Rated input voltage range		100	110/220	240	VAC
Max input voltage range		85		265	VAC
Input voltage frequency range		45	50/60	65	Hz
Maximum Input Current	Vin=85VAC, 100% Load			4.5	A
Input PF value	Vin=110VAC, 100% Load	0.95			
Allowable bus capacitance range ^{Note(1)}	Vin=110/220VAC 100% Load	440		1000	uF

OUTPUT CHARACTERISTICS

Item	Conditions	Min.	Typ.	Max.	Unit
PG high	Good state	3.0	3.2	3.4	V
PG low	Fault state	0		0.8	V
PG delay time	Vbus=0V, Vin >75V to PG signal >1V			2500	ms
PG source current	PG high			+0.3	mA
PG sink current	PG low			-0.3	mA
Output voltage setpoint	Vin=220VAC, Io=0-25A	11.8	12.0	12.2	Vdc
Output current range		0		25	A
Output OCP point		26	30	34	A
Turn-on rise time			15		ms
Start up time	Vin=110/220VAC		1500		mS
Hold up time	Vin=110/220VAC, Io= 100% Load		20		mS
Output OVP point		13	14	15	V
Output Current Transient	Positive voltage step, 75% to 25% load dynamic, 0.1A/us slew rate		300	600	mV
	Negative voltage step, 25% to 75% load dynamic, 0.1A/us slew rate		300	600	mV



Output Voltage Ripple and Noise	Vin=110/220Vac, Io=25, peak to peak, 20MHz bandwidth		100	200	mV
	RMS		50	100	mV
Output overshoot				3	%
Efficiency @ 60% Load	Vin=110VAC		89		%
Efficiency @ 60% Load	Vin=220VAC		91		%
Efficiency @ 100% Load	Vin=110VAC		90		%
Efficiency @ 100% Load	Vin=220VAC		91.5		%
Allowable output capacitance range ^{Note(2)}	Vin=110/220VAC, Io= 100% Load	4000		10000	uF

GENERAL CHARACTERISTICS

Item	Conditions	Min.	Typ.	Max.	Unit
I/O Isolation Voltage	Input to output		3000		VAC
	Input to case		1500		VAC
	Output to case		500		VAC
I/O Isolation Resistance	500Vdc	10			MΩ
MTBF	Ta=25°C, normal input, 100%load		1.2		Mhours
Weight			225		g

ENVIRONMENTAL SPECIFICATIONS

Parameter	Conditions	Min.	Max.	Unit
Storage Temperature Range		-55	+125	°C
Operating Temperature Range	Plate Temperature	-40	+100	°C
Operating altitude			3000	meter
TCT cycle ^{Note(3)}				
THB cycle ^{Note(4)(5)}				

==Note==

- (1) About the bus cap., please find details in section "SIMPLIFIED APPLICATION CIRCUIT".
- (2) About the min. and max. output cap., please find details in section "SIMPLIFIED APPLICATION CIRCUIT".
- (3) The testing conditions of TCT cycle are as follows:
 - 1.1 Temperature Range: -40°C±3°C ~125°C±3°C
 - 1.2 Dwell time: 30min
 - 1.3 Ramp rate: 20°C/min.
 - 1.4 Cycling: 200 cycles
 - 1.5 Units shall be unpowered
- (4) The THB test starts with a pre-conditioning soak of all units for 72hrs under the following conditions:
 - 2.1 Unpowered
 - 2.2 Ambient temperature: 85°C
 - 2.3 Relative humidity: 85%
- (5) The THB Testing is performed for 1000hrs under the following conditions:
 - 3.1 Input Voltage: Maximum Voltage
 - 3.2 Output Load: Minimum load
 - 3.3 Ambient temperature: The max rated ambient temperature or 85°C, whichever is less.
 - 3.4 Relative humidity: 85%

*Specifications are subject to change without notice

ELECTRICAL CURVES

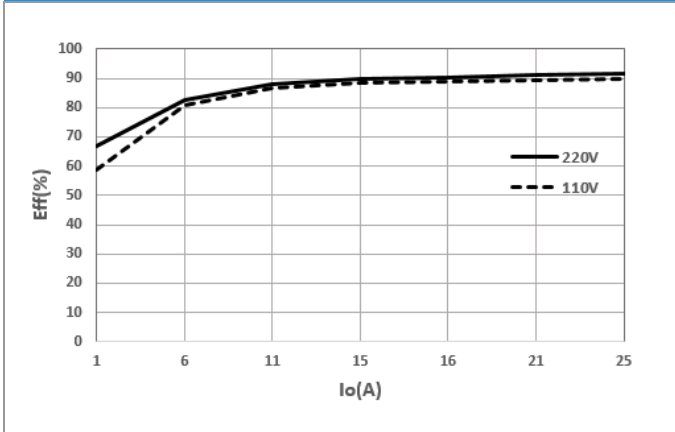

Figure 1: Efficiency vs. Output current @ $V_{in}=110,220VAC$

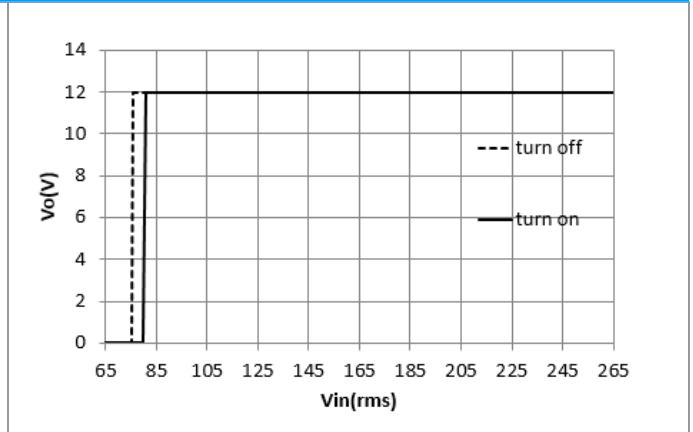

Figure 2: V_{out} vs. V_{in} @ Full load

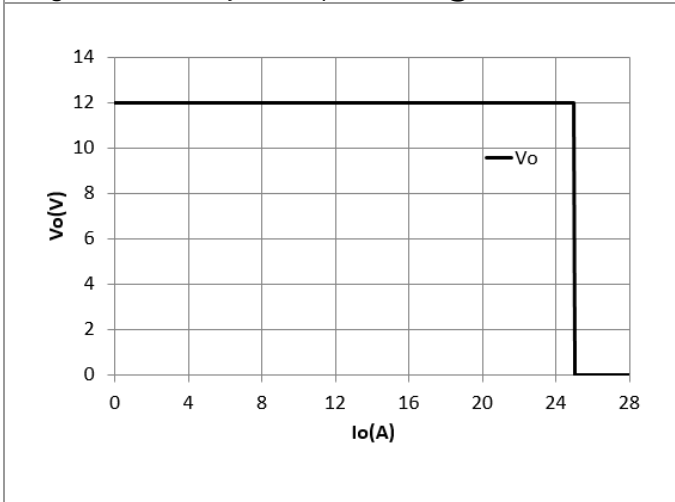

Figure 3: Output voltage vs. Output current @ $V_{in}=110,220VAC$

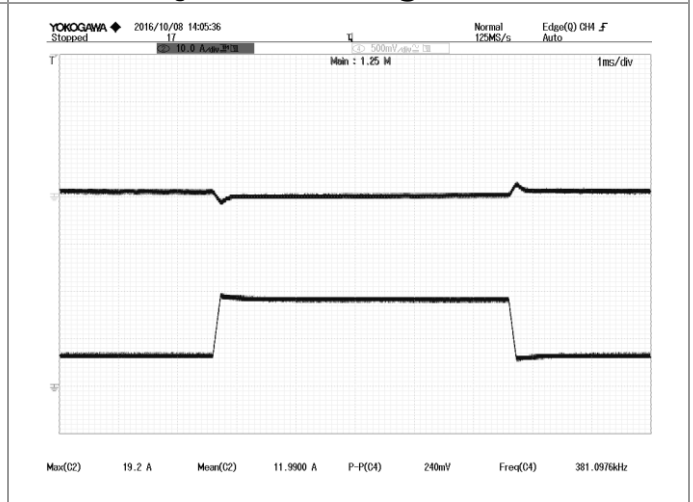

Figure 4: Dynamic response to load step 25%~75% with 0.1A/uS slew rate at 110/220Vac
TOP: V_{out} , 500mV/div, BOTTOM: I_{out} , 10A/div, 1mS/div

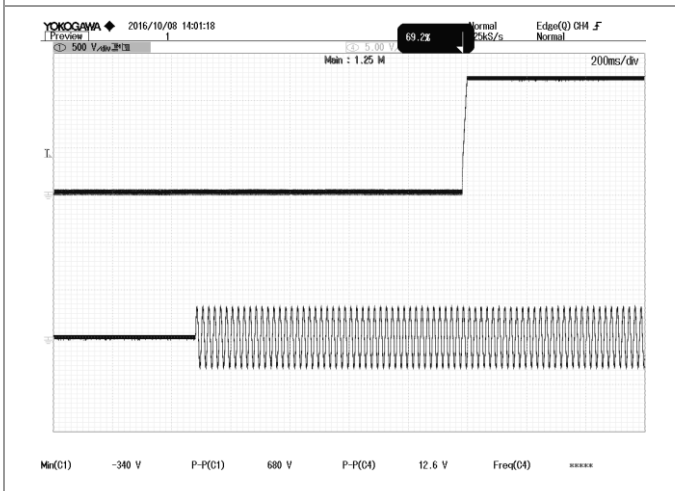

Figure 5: V_{out} start up with Enable on at 220Vac, 25A I_{out} ,
TOP: V_{out} , 5V/div, 200ms/div
BOTTOM: V_{in} , 500V/div, 200ms/div

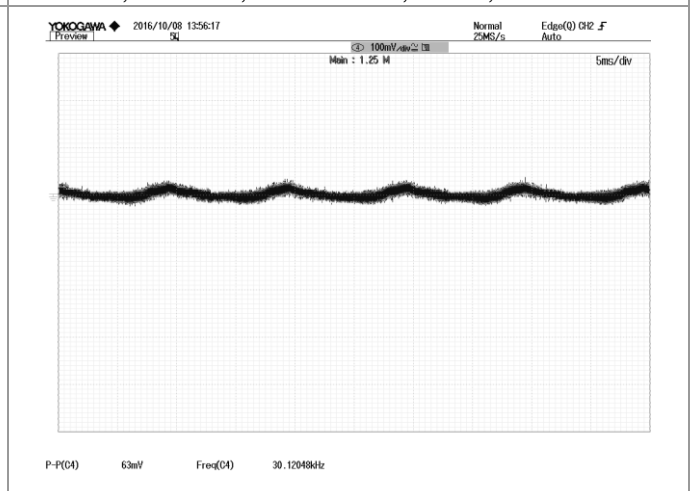

Figure 6: Output ripple & noise at 110/220Vac, 25A I_{out}
VOUT : 100mV/div, 5ms/div

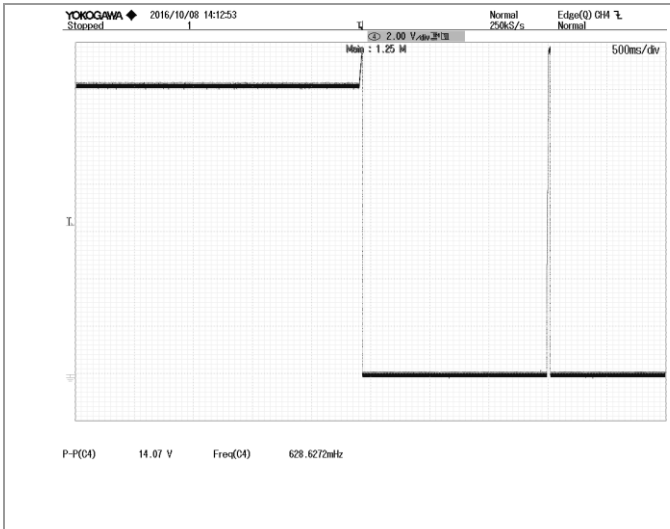

Figure 7: Output over voltage protection at 110/220Vac, 25A_{out} VOUT: 2V/div, 500mS/div

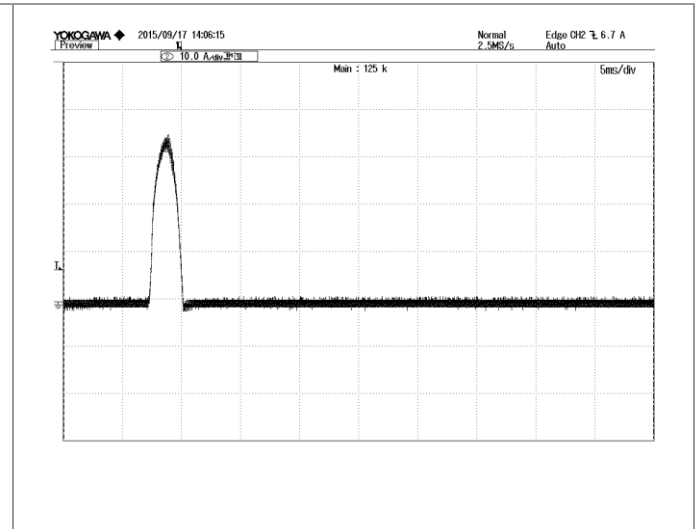

Figure 8: Inrush current @ Vin=220Vac lin: 10A/div, 5mS/div

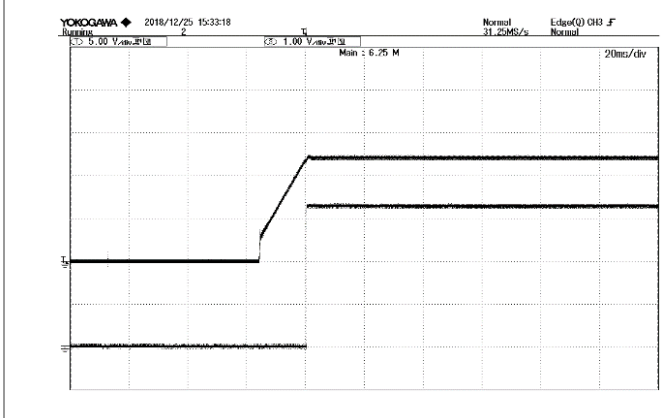
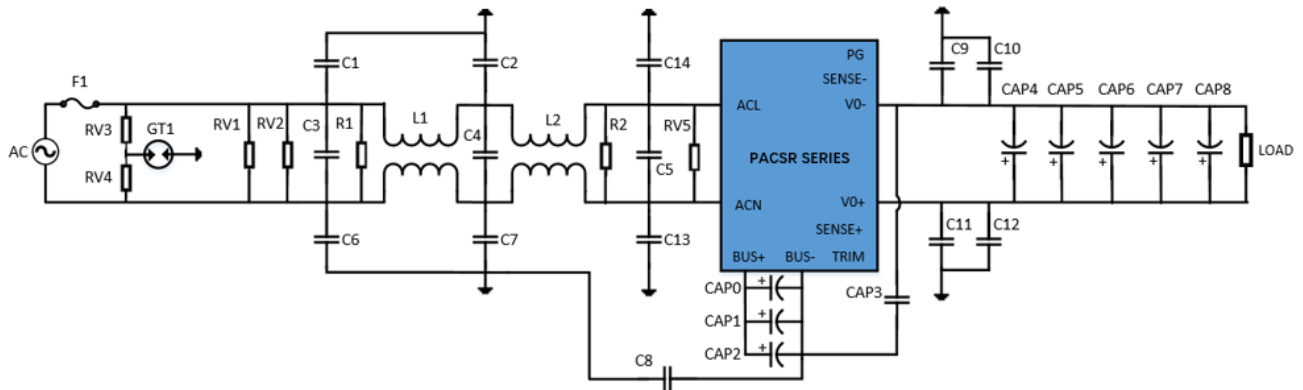

Figure 9: PG voltage vs. Vout @ Vin=220Vac, 0A_{out} TOP: Vout, 5V/div, 20mS/div BOTTOM: PG, 1V/div, 20mS/div

SIMPLIFIED APPLICATION CIRCUIT



Note: PACSR series does not support parallel application

Figure 10: Application connection

TYPICAL value ADVISED

No	Location	Item	Value	Part Number
1	Cap0	Bus cap	220uF/450V	Capacitor should have good low-temperature characteristics, keep at least 75% capacitance at -40°C if need -40C application. ^{Note(6)}
2	Cap1	Bus cap	220uF/450V	
3	Cap2	Bus cap	220uF/450V	
4	Cap3	Cap for pri-sec	2200pF/250Vac Y1/X1	ESR ≤ 8m Ω (100kHz), Rated ripple ≥ 7000mArms(125°C) ^{Note(7)}
5	Cap4	Output cap	820uF/16V	
6	Cap5	Output cap	820uF/16V	
7	Cap6	Output cap	820uF/16V	
8	Cap7	Output cap	820uF/16V	
9	Cap8	Output cap	820uF/16V	
10	F1	Input fuse	10A/250Vac	
11	RV1	Input VDR	300VAC	TVR14471K0OOTB9Y/THINKING
12	RV2	Input VDR	300VAC	TVR14471K0OOTB9Y/THINKING
13	RV3	Input VDR	300VAC	TVR14471K0OOTB9Y/THINKING
14	RV4	Input VDR	300VAC	TVR14471K0OOTB9Y/THINKING
15	RV5	Input VDR	300VAC	TVR14471K0OOTB9Y/THINKING
16	GT1	Input GAS TUBE	2.5KV/10KA	B88069X8661S102(EF2500X8S)
17	C1	Input Y-cap	100pF/250Vac Y2/X1	
18	C2	Input Y-cap	4700pF/250Vac Y2/X1	
19	C3	Input X-cap	1uF /305VAC X2	
20	C4	Input X-cap	0.47uF /275VAC X2	
21	C5	Input X-cap	0.47uF /275VAC X2	
22	C6	Input Y-cap	100pF/250Vac Y2/X1	
23	C7	Input Y-cap	4700pF/250Vac Y2/X1	
24	C8	Cap for pri-PE	1500pF/250Vac Y1/X1	
25	C9	Output Y-cap	4700pF/250Vac Y2/X1	
26	C10	Output Y-cap	4700pF/250Vac Y2/X1	
27	C11	Output Y-cap	4700pF/250Vac Y2/X1	
28	C12	Output Y-cap	4700pF/250Vac Y2/X1	
29	C13	Input Y-cap	100pF/250Vac Y2/X1	



30	C14	Input Y-cap	100pF/250Vac Y2/X1	
31	L1	Input chock	11mH ϕ1mm	
32	L2	Input chock	11mH ϕ1mm	
33	R1	Input RES	1/4W 820Kohm	
34	R2	Input RES	1/4W 820Kohm	

*read the Application Note for this module carefully before using the power supply unit

==Note==

(1) and (6): About the bus cap., please read the Application Note about the hold up time configure.

(2) and (7): About the min. output cap., please use the cap. which has more performance than the cap. in the table above, or refer the cap. about the output cap. ability in the Application Note.

(2): About the max. output cap., please follow the Application Note about the output cap. ability.

THERMAL CONSIDERATION

Thermal management is an important part of the system design. To ensure proper, reliable operation, sufficient cooling of the power module is needed over the entire temperature range of the module. Conduction cooling is usually the dominant mode of heat transfer.

Thermal Testing Setup

The following figure shows the testing setup in which the power module is mounted on an Al plate and was cooled by cooling liquid.

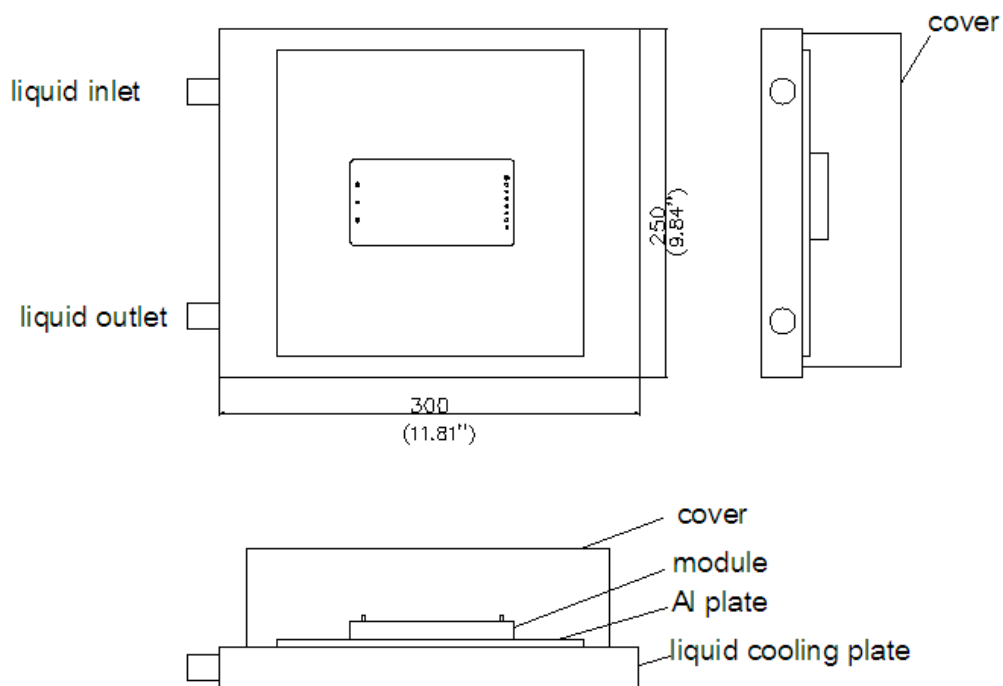

Figure 11: Thermal test setup

THERMAL DERATING CURVE

The following figure shows the location to monitor the temperature of the module's baseplate. The baseplate temperature in thermal curve is a reference for customer to make thermal evaluation and make sure the module is operated under allowable temperature. (Thermal curves shown in Figure13 are based on different input voltage).

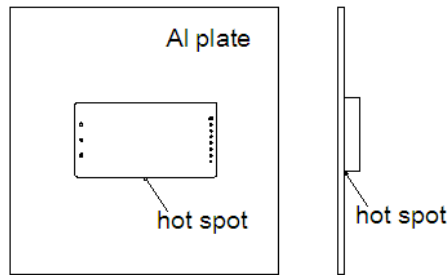

Figure 12: Baseplate's temperature measured point

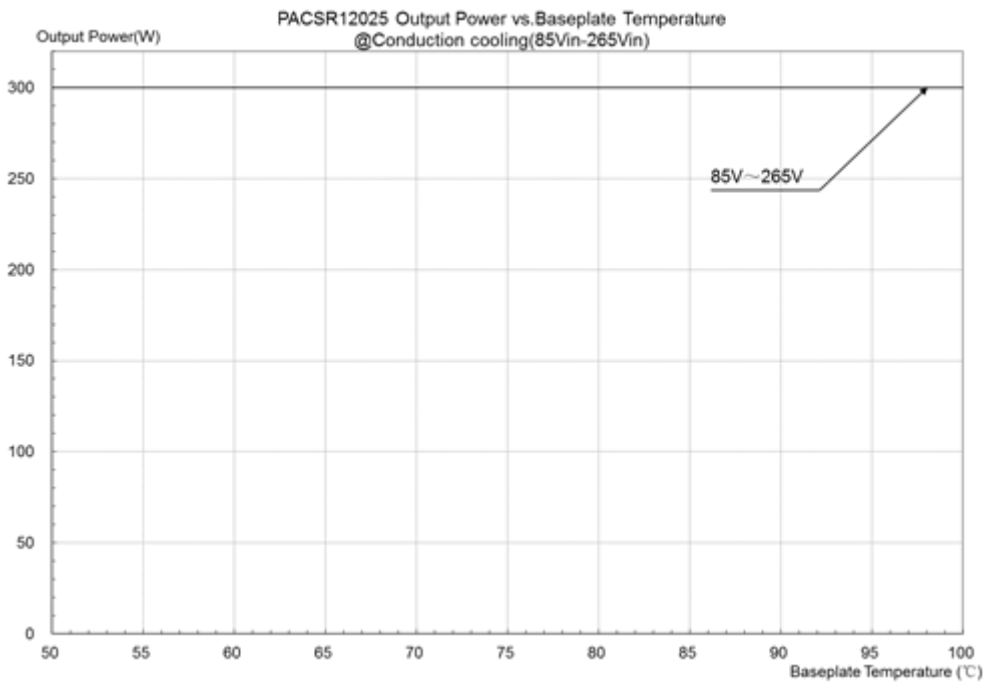
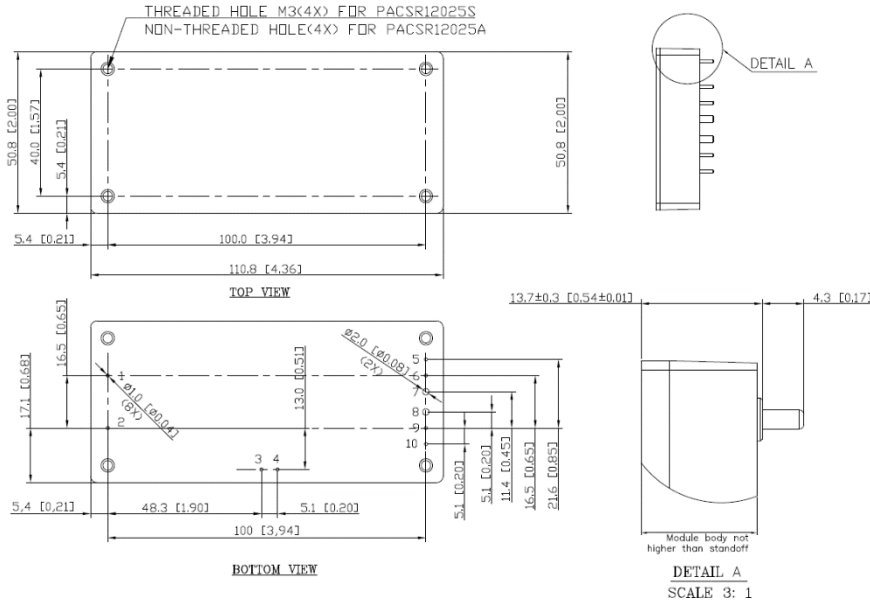

Figure 13: Thermal derating curves

MECHANICAL DRAWING

Mechanical Dimensions



Pin Connection

Pin	Function
1	ACL
2	ACN
3	BUS+
4	BUS-
5	PG
6	SENSE-
7	VOU-
8	VOU+
9	SENSE+
10	NC

All dimensions in mm (inches)
Tolerance: X.X±0.5 (X.XX±0.02)
X.XX±0.25 (X.XXX±0.010)

RECOMMENDED P.W.B PAD LAYOUT

RECOMMENDED P.W.B. PAD LAYOUT

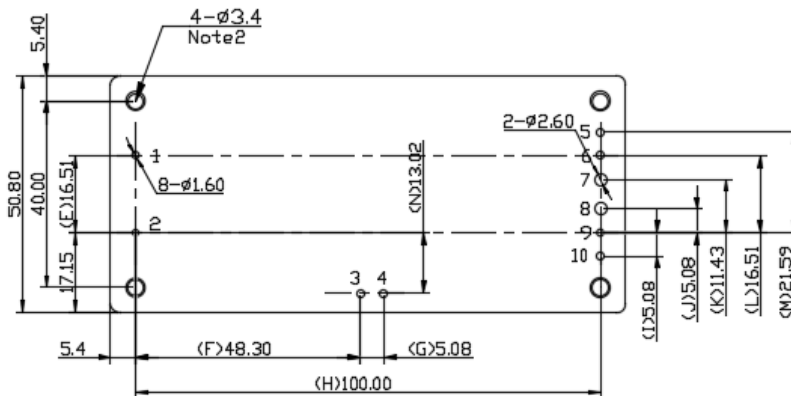

NOTE1:

FOR MODULES WITH THROUGH-HOLE PINS AND THE OPTIONAL HEAT SPREADER, THEY ARE INTENDED FOR WAVE SOLDERING ASSEMBLY ON TO SYSTEM BOARDS. PLEASE DO NOT SUBJECT SUCH MODULES THROUGH REFLOW TEMPERATURE PROFILE.

NOTE2:

AT THESE FOUR HOLES POSITION, IT SHOULD USE SCREWS TO FIX THE POWER MODULE ON CUSTOMER SYSTEM BOARD.

PIN #	FUNCTION	D_PIN
1	ACL	∅1.00
2	ACN	∅1.00
3	Bus+	∅1.00
4	Bus-	∅1.00
5	PG	∅1.00
6	Sense-	∅1.00
7	Vout-	∅2.00
8	Vout+	∅2.00
9	Sense+	∅1.00
10	NC	∅1.00

SOLDERING METHOD

Generally, as the most common mass soldering method for the solder attachment, wave soldering is used for through-hole power modules and reflow soldering is used for surface-mount ones. Delta recommended soldering methods and process parameters are provided in this document for solder attachment of power modules onto system board. SAC305 is the suggested lead-free solder alloy for all soldering methods. The soldering temperature profile presented in this document is based on SAC305 solder alloy.

Reflow soldering is not a suggested method for through-hole power modules due to many process and reliability concerns. If you have this kind of application requirement, please contact Delta sales or FAE for further confirmation.

Wave Soldering (Lead-free)

Delta's power modules are designed to be compatible with single-wave or dual wave soldering. The suggested soldering process must keep the power module's internal temperature below the critical temperature of 217°C continuously. The recommended wave-soldering profile is shown below:

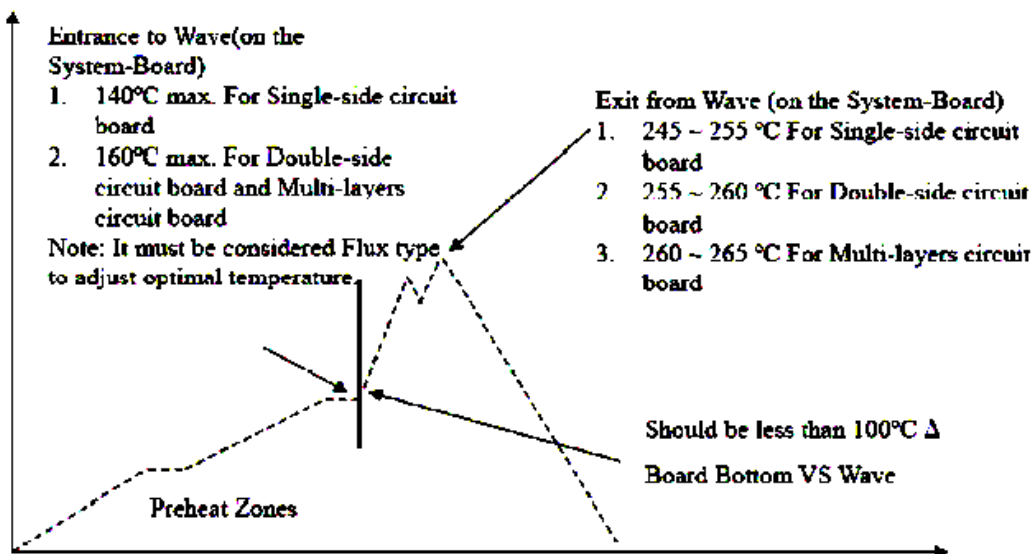

Note: The temperature is measured on solder joint of pins of power module.

The typical recommended (for double-side circuit board) preheat temperature is 115±10°C on the top side (component side) of the circuit board. The circuit-board bottom-side preheat temperature is typically recommended to be greater than 135°C and preferably within 100°C of the solder-wave temperature. A maximum recommended preheat up rate is 3°C /s. A maximum recommended solder pot temperature is 255±5°C with solder-wave dwell time of 3~6 seconds. The cooling down rate is typically recommended to be 6°C/s maximum.



Hand Soldering (Lead Free)

Hand soldering is the least preferred method because the amount of solder applied, the time the soldering iron is held on the joint, the temperature of the iron, and the temperature of the solder joint are variable. The recommended hand soldering guideline is listed in Table below. The suggested soldering process must keep the power module's internal temperature below the critical temperature of 217°C continuously.

Parameter	Single-side Circuit Board	Double-side Circuit Board	Multi-side Circuit Board
Soldering Iron Wattage	90W	90W	90W
Tip Temperature	385+/-10°C	420+/-10°C	420+/-10°C
Soldering Time	2 ~ 6 seconds	4 ~ 10 seconds	4 ~ 10 seconds

PHYSICAL OUTLINE

Case Size	: 110.8x50.8x13.7mm (4.33"x2.00"x0.54")
Case Material	: AL6061+Plastic case
Weight	: 225g

PART NUMBERING SYSTEM

P	AC	S	R	12	025	A
Form Factor	Rated Input Voltage	Number of Outputs	Product Series	Output Voltage	Output Current	Option Code
P - Module	AC - 100VAC~240VAC	S - Single	R - Regular	12V	25A	A - Through hole S - Screw hole(M3*0.5)

MODEL LIST

Model name	Rated Input		Output		EFF @220VAC 100% LOAD
PACSR12025A	100VAC~240VAC	3.8A	12V	25A	91.5%
PACSR12025S	100VAC~240VAC	3.8A	12V	25A	91.5%

WARRANTY

Delta offers a three (3) years limited warranty. Complete warranty information is listed on our web site or is available upon request from Delta.

Information furnished by Delta is believed to be accurate and reliable. However, no responsibility is assumed by Delta for its use, nor for any infringements of patents or other rights of third parties, which may result from its use. No license is granted by implication or otherwise under any patent or patent rights of Delta. Delta reserves the right to revise these specifications at any time, without notice.

Компания «Океан Электроники» предлагает заключение долгосрочных отношений при поставках импортных электронных компонентов на взаимовыгодных условиях!

Наши преимущества:

- Поставка оригинальных импортных электронных компонентов напрямую с производств Америки, Европы и Азии, а так же с крупнейших складов мира;
- Широкая линейка поставок активных и пассивных импортных электронных компонентов (более 30 млн. наименований);
- Поставка сложных, дефицитных, либо снятых с производства позиций;
- Оперативные сроки поставки под заказ (от 5 рабочих дней);
- Экспресс доставка в любую точку России;
- Помощь Конструкторского Отдела и консультации квалифицированных инженеров;
- Техническая поддержка проекта, помощь в подборе аналогов, поставка прототипов;
- Поставка электронных компонентов под контролем ВП;
- Система менеджмента качества сертифицирована по Международному стандарту ISO 9001;
- При необходимости вся продукция военного и аэрокосмического назначения проходит испытания и сертификацию в лаборатории (по согласованию с заказчиком);
- Поставка специализированных компонентов военного и аэрокосмического уровня качества (Xilinx, Altera, Analog Devices, Intersil, Interpoint, Microsemi, Actel, Aeroflex, Peregrine, VPT, Syfer, Eurofarad, Texas Instruments, MS Kennedy, Miteq, Cobham, E2V, MA-COM, Hittite, Mini-Circuits, General Dynamics и др.);

Компания «Океан Электроники» является официальным дистрибьютором и эксклюзивным представителем в России одного из крупнейших производителей разъемов военного и аэрокосмического назначения «JONHON», а так же официальным дистрибьютором и эксклюзивным представителем в России производителя высокотехнологичных и надежных решений для передачи СВЧ сигналов «FORSTAR».



JONHON

«JONHON» (основан в 1970 г.)

Разъемы специального, военного и аэрокосмического назначения:

(Применяются в военной, авиационной, аэрокосмической, морской, железнодорожной, горно- и нефтедобывающей отраслях промышленности)

«FORSTAR» (основан в 1998 г.)

ВЧ соединители, коаксиальные кабели, кабельные сборки и микроволновые компоненты:

(Применяются в телекоммуникациях гражданского и специального назначения, в средствах связи, РЛС, а так же военной, авиационной и аэрокосмической отраслях промышленности).



Телефон: 8 (812) 309-75-97 (многоканальный)

Факс: 8 (812) 320-03-32

Электронная почта: ocean@oceanchips.ru

Web: <http://oceanchips.ru/>

Адрес: 198099, г. Санкт-Петербург, ул. Калинина, д. 2, корп. 4, лит. А