

# FGH75T65SHDTLN4

## Product Preview

### Field Stop Trench IGBT 75 A, 650 V

Using the novel field stop 3rd generation IGBT technology, FGH75T65SHDTLN4 offers the optimum performance for solar inverter, UPS, welder, telecom, ESS and PFC applications where low conduction loss and switching loss are essential.

#### Features

- Maximum Junction Temperature:  $T_J = 175^\circ\text{C}$
- Positive Temperature Co-efficient for Easy Parallel Operating
- High Current Capability
- Low Saturation Voltage:  $V_{CE(\text{Sat})} = 1.6\text{ V (Typ.) @ } I_C = 75\text{ A}$
- 100% of the Parts Tested for  $I_{LM}(1)$
- High Input Impedance
- Fast Switching
- Tight Parameter Distribution
- Pb Free and RoHS Compliant
- Not Recommended for Reflow and Full PKG Dipping

#### Typical Applications

- Solar Inverter
- UPS
- Welder
- Telecom
- ESS
- PFC

#### MAXIMUM RATINGS ( $T_J = 25^\circ\text{C}$ unless otherwise noted)

Parameter	Symbol	Value	Unit	
Collector-to-Emitter Voltage	$V_{CES}$	650	V	
Gate-to-Emitter Voltage Transient Gate-to-Emitter Voltage	$V_{GES}$	$\pm 20$ $\pm 30$	V	
Collector Current	$I_C$	$T_C = 25^\circ\text{C}$	150	A
		$T_C = 100^\circ\text{C}$	75	
Pulsed Collector Current (Note 1)	$I_{LM}$	300	A	
Pulsed Collector Maximum Current (Note 2)	$I_{CM}$	300	A	
Diode Forward Current	$I_F$	$T_C = 25^\circ\text{C}$	125	A
		$T_C = 100^\circ\text{C}$	75	
Pulsed Diode Maximum Forward Current (Note 2)	$I_{FM}$	300	A	
Maximum Power Dissipation	$P_D$	$T_C = 25^\circ\text{C}$	455	W
		$T_C = 100^\circ\text{C}$	227	
Operating Junction and Storage Temperature Range	$T_J, T_{STG}$	-55 to +175	$^\circ\text{C}$	
Maximum Lead Temperature for Soldering Purposes (1/8" from case for 5 seconds)	$T_L$	300	$^\circ\text{C}$	

Stresses exceeding those listed in the Maximum Ratings table may damage the device. If any of these limits are exceeded, device functionality should not be assumed, damage may occur and reliability may be affected.

1.  $V_{CC} = 400\text{ V}$ ,  $V_{GE} = 15\text{ V}$ ,  $I_C = 300\text{ A}$ ,  $R_G = 73\ \Omega$ , Inductive Load
2. Repetitive rating: pulse width limited by max. Junction temperature

This document contains information on a product under development. ON Semiconductor reserves the right to change or discontinue this product without notice.



ON Semiconductor®

[www.onsemi.com](http://www.onsemi.com)

75 A, 650 V  
 $V_{CE(\text{sat})} = 1.6\text{ V}$   
 $E_{on} = 1.06\text{ mJ}$

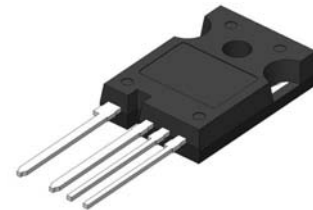
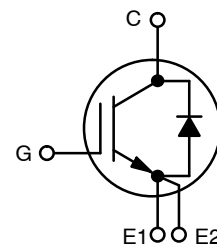

TO-247  
THIN LEADS  
CASE 340CW

#### DEVICE MARKING INFORMATION

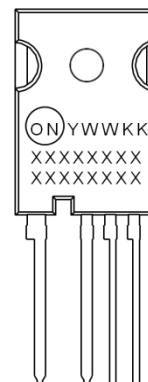

Line 1: Date Code  
Line 2: Device Marking  
Line 3: Device Marking

#### ORDERING INFORMATION

Device	Package	Shipping
FGH75T65SHDTLN4	TO-247	30 Units / Tube

# FGH75T65SHDTLN4

**Table 1. THERMAL CHARACTERISTICS**

Symbol	Parameter	Value	Unit
$R_{\theta JC}$	Thermal Resistance, Junction to Case, for IGBT	0.33	$^{\circ}\text{C}/\text{W}$
$R_{\theta JC}$	Thermal Resistance, Junction to Case, for Diode	0.65	$^{\circ}\text{C}/\text{W}$
$R_{\theta JA}$	Thermal Resistance, Junction to Ambient	40	$^{\circ}\text{C}/\text{W}$

**Table 2. ELECTRICAL CHARACTERISTICS** ( $T_J = 25^{\circ}\text{C}$  unless otherwise noted)

Parameter	Symbol	Test Condition	Min	Typ	Max	Unit
-----------	--------	----------------	-----	-----	-----	------

**OFF CHARACTERISTICS**

Collector-emitter breakdown voltage, gate-emitter short-circuited	$BV_{CES}$	$V_{GE} = 0\text{ V}, I_C = 1\text{ mA}$	650	-	-	V
Temperature Coefficient of Breakdown Voltage	$\Delta BV_{CES}/\Delta T_J$	$V_{GE} = 0\text{ V}, I_C = 1\text{ mA}$	-	0.65	-	$\text{V}/^{\circ}\text{C}$
Collector-emitter cut-off current, gate-emitter short-circuited	$I_{CES}$	$V_{GE} = 0\text{ V}, V_{CE} = 650\text{ V}$	-	-	250	$\mu\text{A}$
Gate leakage current, collector-emitter short-circuited	$I_{GES}$	$V_{GE} = \pm 20\text{ V}, V_{CE} = 0\text{ V}$	-	-	$\pm 400$	nA

**ON CHARACTERISTICS**

Gate-emitter threshold voltage	$V_{GE(th)}$	$V_{GE} = V_{CE}, I_C = 75\text{ mA}$	4.0	5.5	7.5	V
Collector-emitter saturation voltage	$V_{CE(sat)}$	$V_{GE} = 15\text{ V}, I_C = 75\text{ A}, V_{GE} = 15\text{ V}, I_C = 75\text{ A}, T_J = 175^{\circ}\text{C}$	-	1.6 2.28	2.1 -	$\text{mV}/^{\circ}\text{C}$

**DYNAMIC CHARACTERISTICS**

Input Capacitance	$C_{ies}$	$V_{CE} = 30\text{ V}, V_{GE} = 0\text{ V}, f = 1\text{ MHz}$	-	3710	-	pF
Output Capacitance	$C_{oes}$		-	183	-	
Reverse Transfer Capacitance	$C_{res}$		-	43	-	
Gate Charge Total	$Q_g$	$V_{CE} = 400\text{ V}, I_C = 75\text{ A}, V_{GE} = 15\text{ V}$	-	126	-	nC
Gate-to-Emitter Charge	$Q_{ge}$		-	24.1	-	
Gate-to-Collector Charge	$Q_{gc}$		-	47.6	-	

**SWITCHING CHARACTERISTICS, INDUCTIVE LOAD**

Turn-On Delay Time	$t_{d(on)}$	$T_C = 25^{\circ}\text{C}$ $V_{CC} = 400\text{ V}, I_C = 75\text{ A}$ $R_g = 15\ \Omega$ $V_{GE} = 15\text{ V}$ Inductive Load, $T_C = 25^{\circ}\text{C}$	-	55	-	ns
Rise Time	$t_r$		-	50	-	
Turn-Off Delay Time	$t_{d(off)}$		-	189	-	
Fall Time	$t_f$		-	39	-	
Turn-On Switching Loss	$E_{on}$	$V_{CC} = 400\text{ V}, I_C = 75\text{ A}$ $R_g = 15\ \Omega$ $V_{GE} = 15\text{ V}$ Inductive Load, $T_C = 175^{\circ}\text{C}$	-	1.06	-	mJ
Turn-Off Switching Loss	$E_{off}$		-	1.56	-	
Total Switching Loss	$E_{ts}$		-	2.62	-	
Turn-On Delay Time	$t_{d(on)}$		-	48	-	ns
Rise Time	$t_r$		-	56	-	
Turn-Off Delay Time	$t_{d(off)}$		-	205	-	
Fall Time	$t_f$		-	40	-	
Turn-On Switching Loss	$E_{on}$		-	2.34	-	mJ
Turn-Off Switching Loss	$E_{off}$		-	1.81	-	
Total Switching Loss	$E_{ts}$		-	4.15	-	

**DIODE CHARACTERISTICS**

Forward voltage	$V_F$	$I_F = 75\text{ A}$ $I_F = 75\text{ A}, T_J = 175^{\circ}\text{C}$	-	1.8 1.7	2.1 -	V
-----------------	-------	---	---	------------	----------	---

# FGH75T65SHDTLN4

**Table 2. ELECTRICAL CHARACTERISTICS** ( $T_J = 25^\circ\text{C}$  unless otherwise noted)

Parameter	Symbol	Test Condition	Min	Typ	Max	Unit
<b>DIODE CHARACTERISTICS</b>						
Reverse Recovery Time	$t_{rr}$	$T_J = 25^\circ\text{C}$ $I_F = 75\text{ A}, di_F/dt = 200\text{ A}/\mu\text{s}$	-	36	-	ns
Reverse Recovery Charge	$Q_{rr}$		-	18	-	
Reverse Recovery Time	$t_{rr}$	$T_J = 175^\circ\text{C}$ $I_F = 75\text{ A}, di_F/dt = 200\text{ A}/\mu\text{s}$	-	270	-	ns
Reverse Recovery Charge	$Q_{rr}$		-	2199	-	$\mu\text{C}$
Reverse Recovery Energy	$E_{rec}$		-	160	-	$\mu\text{J}$

Product parametric performance is indicated in the Electrical Characteristics for the listed test conditions, unless otherwise noted. Product performance may not be indicated by the Electrical Characteristics if operated under different conditions.

# FGH75T65SHDTLN4

## TYPICAL CHARACTERISTICS

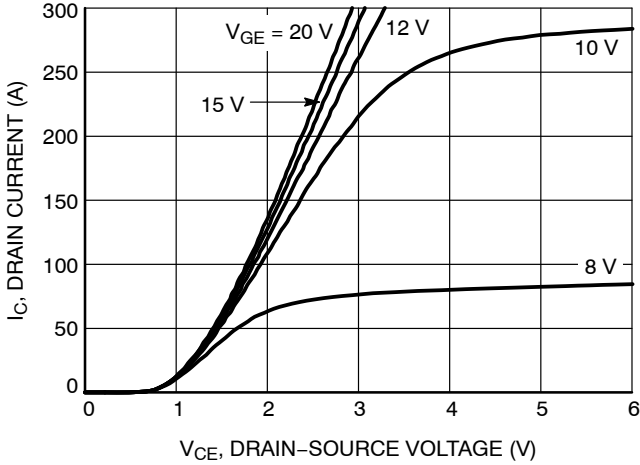

Figure 1. Typical Output Characteristics (25°C)

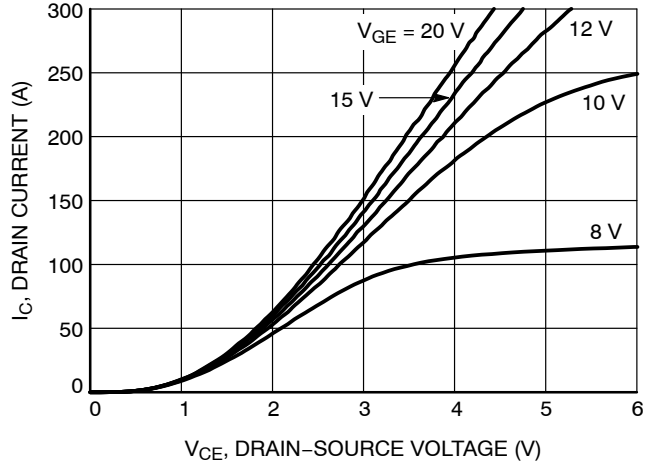

Figure 2. Typical Output Characteristics (175°C)

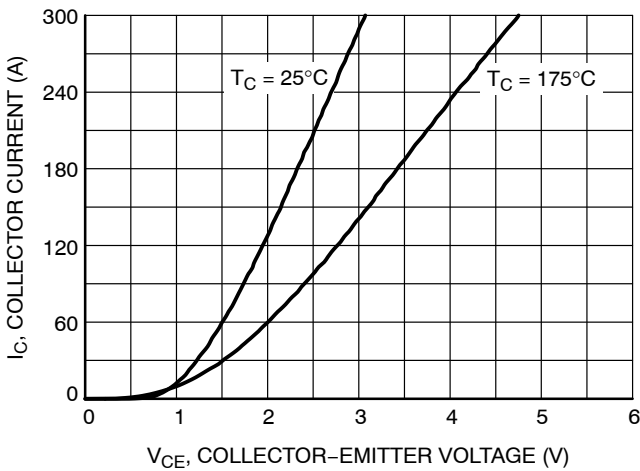

Figure 3. Typical Saturation Voltage Characteristics

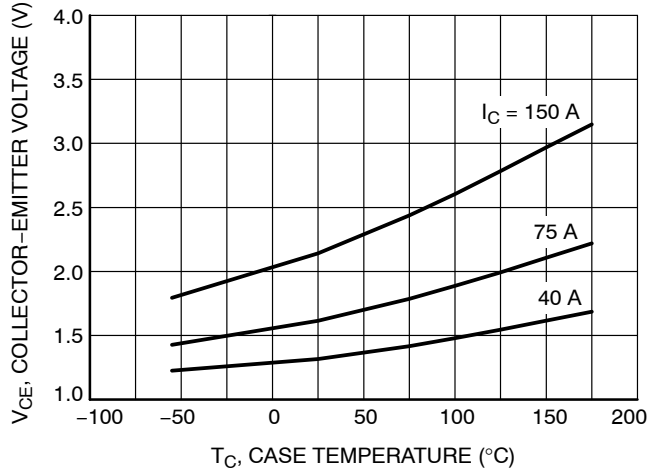

Figure 4. Saturation Voltage vs. Case Temperature at Variant Current Level

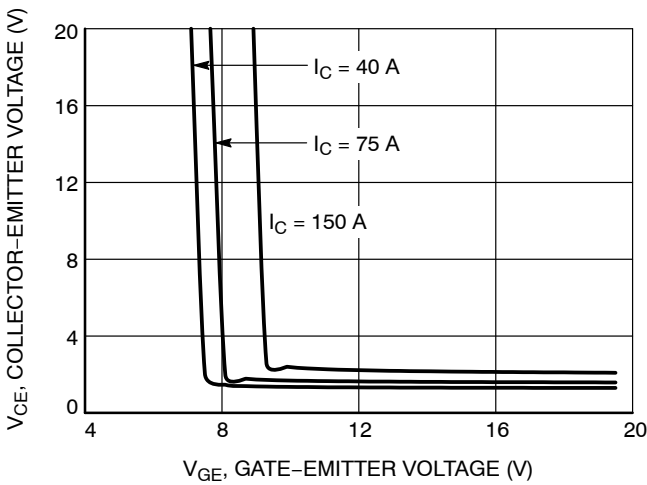

Figure 5. Saturation Voltage vs.  $V_{GE}$  (25°C)

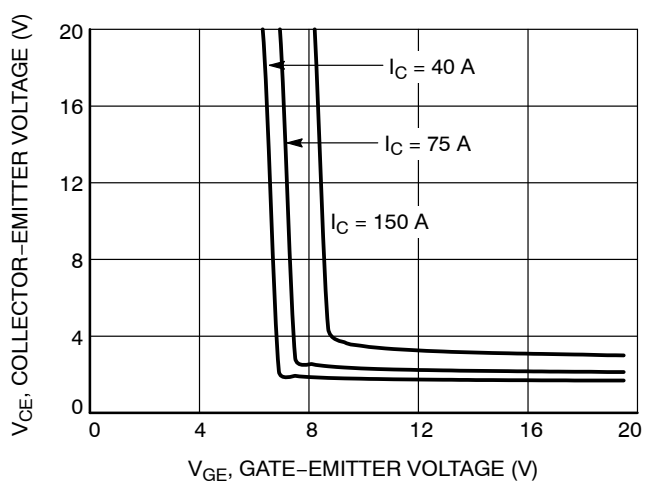

Figure 6. Saturation Voltage vs.  $V_{GE}$  (175°C)

# FGH75T65SHDTLN4

## TYPICAL CHARACTERISTICS

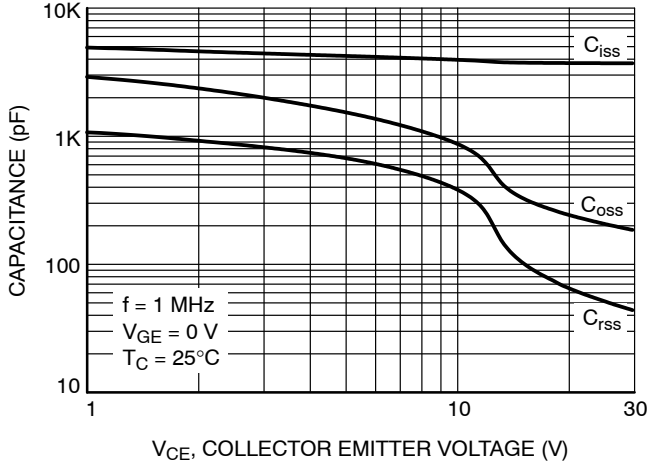

Figure 7. Capacitance Characteristics

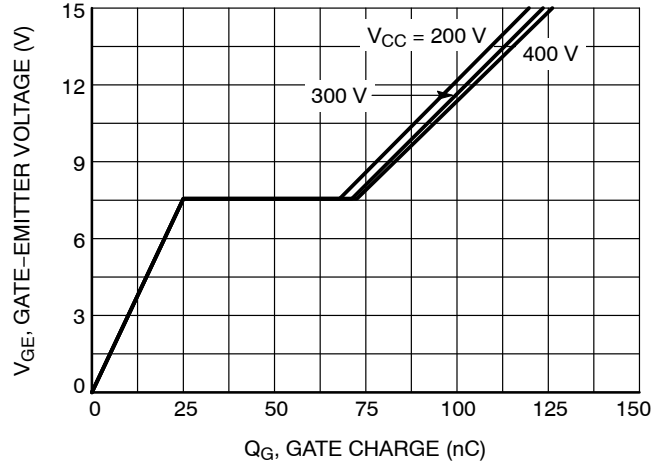

Figure 8. Gate Charge Characteristics

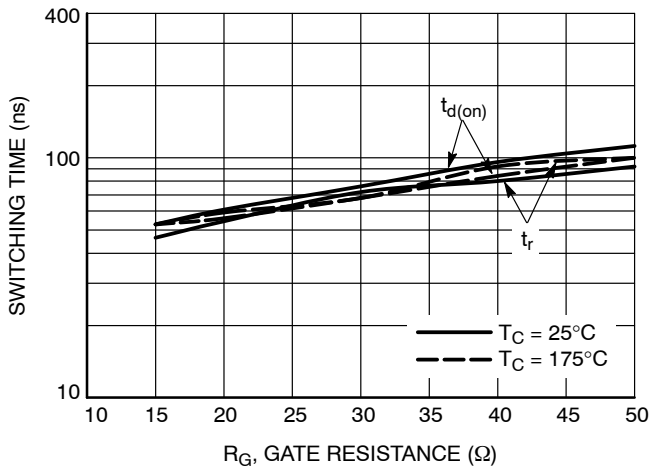

Figure 9. Turn-On Characteristics vs. Gate Resistance

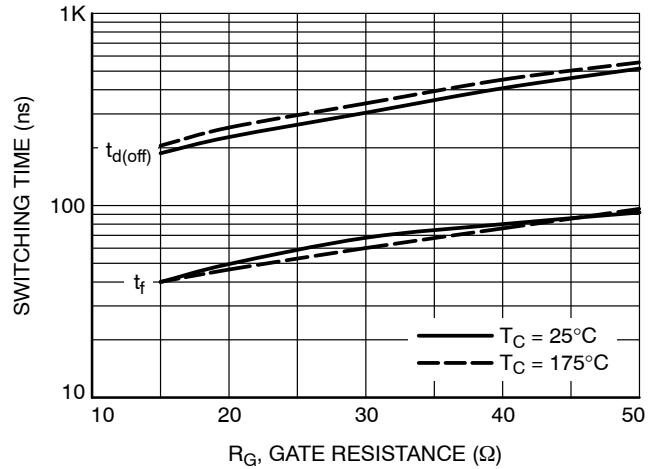

Figure 10. Turn-Off Characteristics vs. Gate Resistance

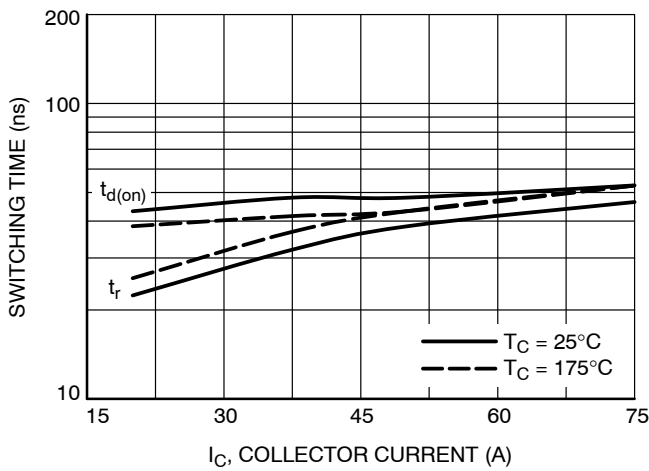

Figure 11. Turn-On Characteristics vs. Collector Current

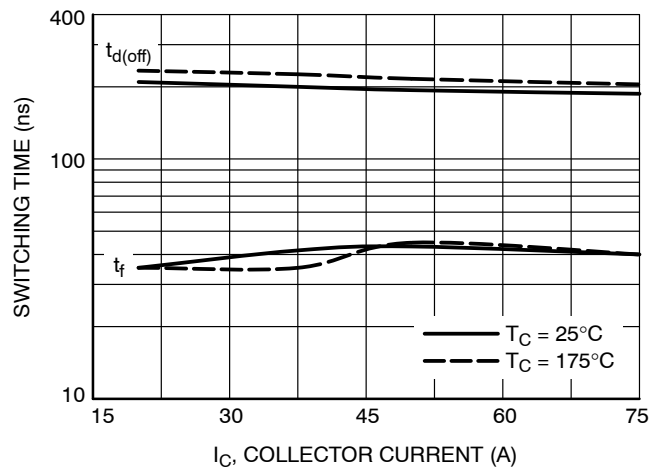

Figure 12. Turn-Off Characteristics vs. Collector Current

# FGH75T65SHDTLN4

## TYPICAL CHARACTERISTICS

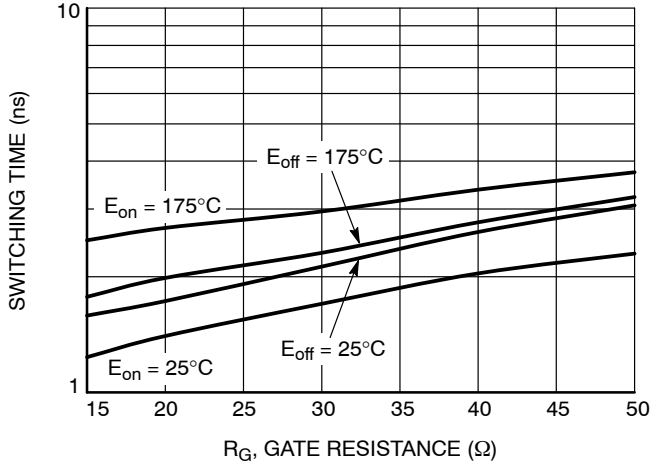

Figure 13. Switching Loss vs. Gate Resistance

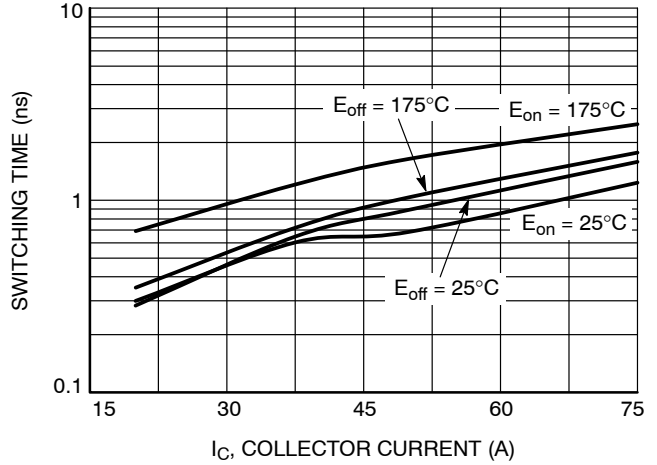

Figure 14. Switching Loss vs. Collector Current

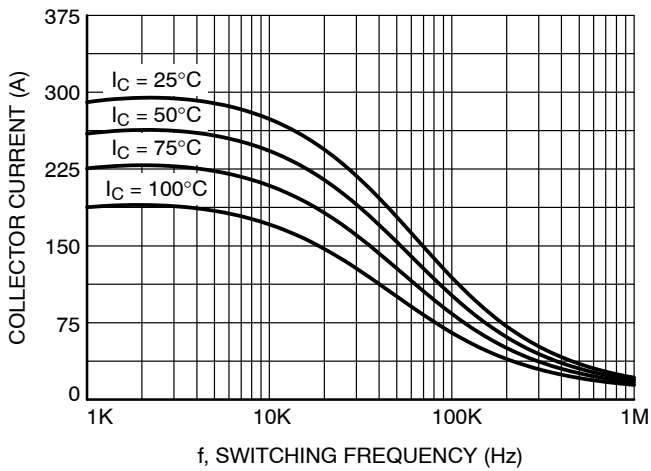

Figure 15. Load Frequency Template

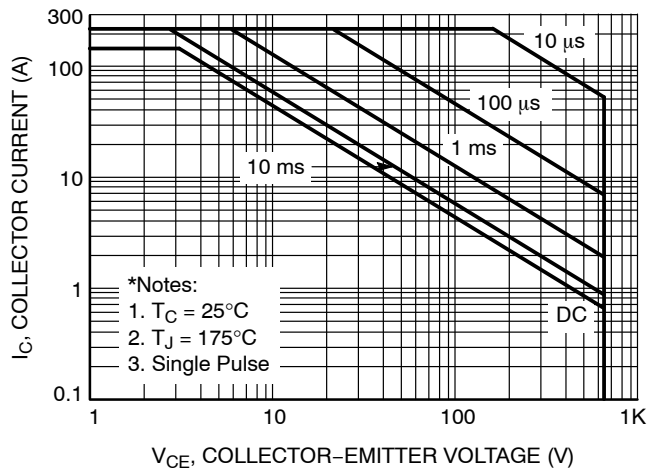

Figure 16. SOA Characteristics

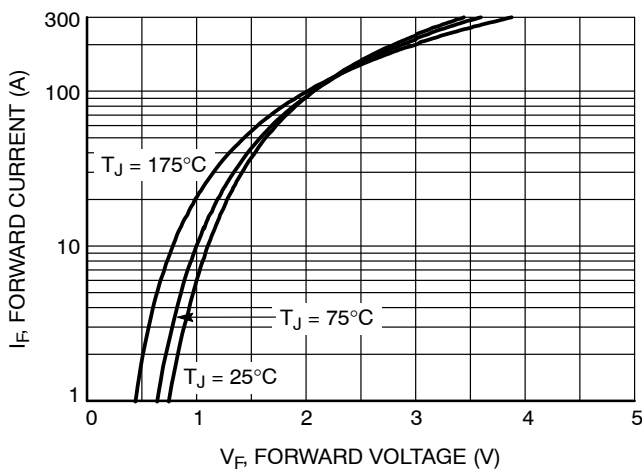

Figure 17. Forward Characteristics

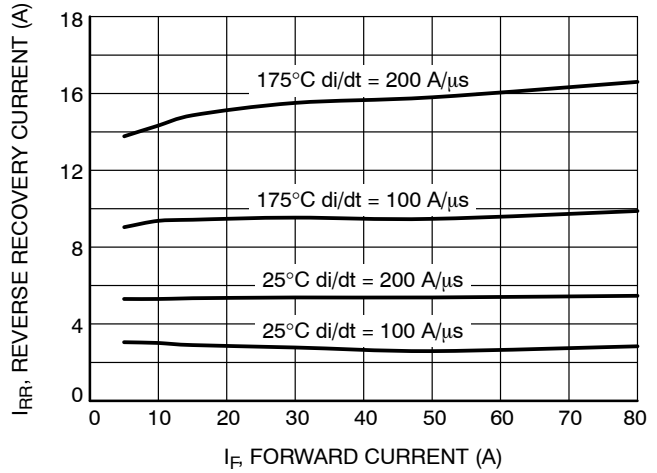

Figure 18. Reverse Recovery Current

# FGH75T65SHDTLN4

## TYPICAL CHARACTERISTICS

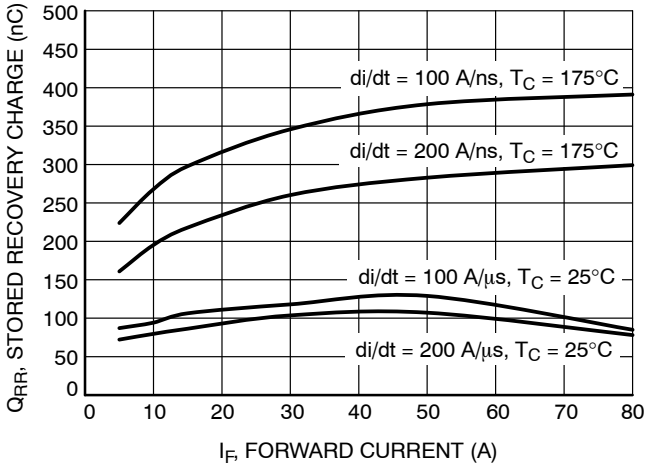

Figure 19. Reverse Recovery Time

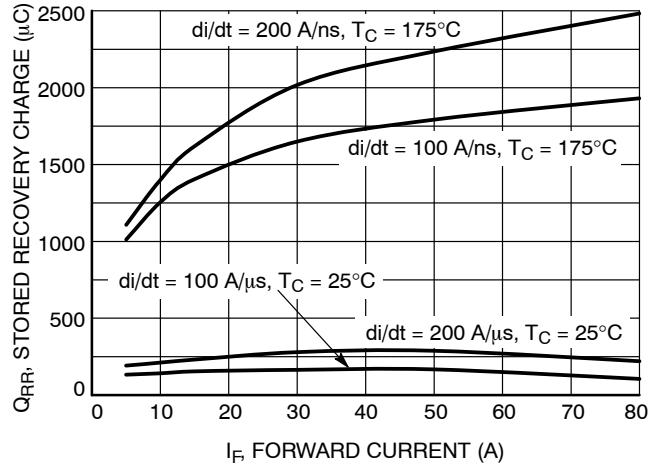

Figure 20. Stored Charge

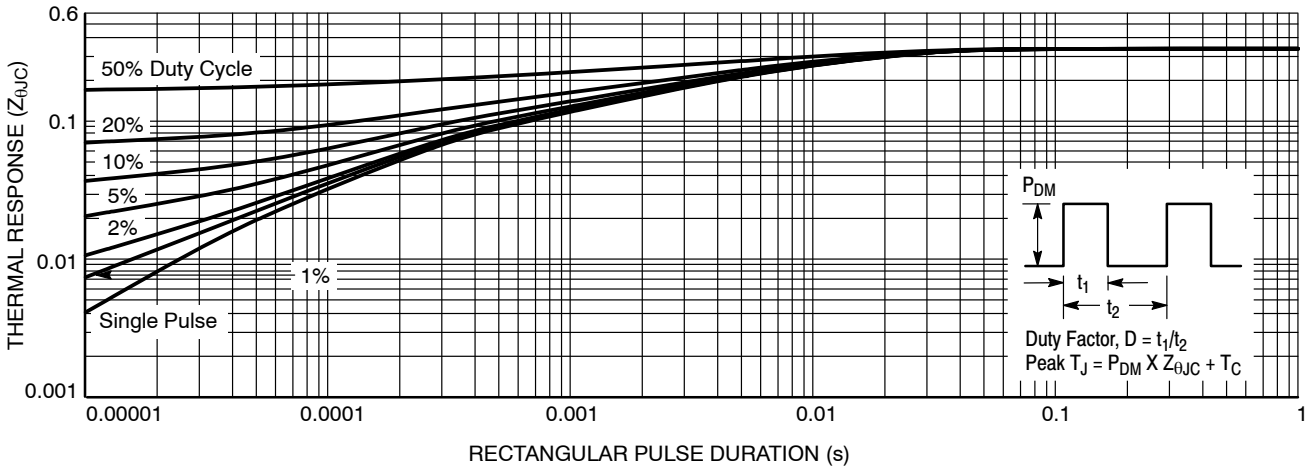

Figure 21. Transient Thermal Impedance of IGBT

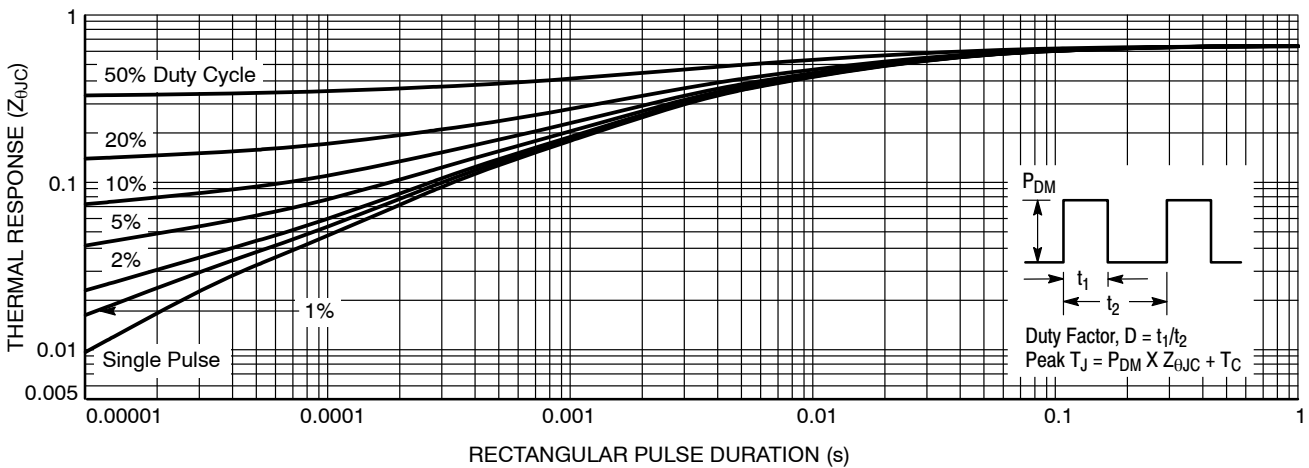
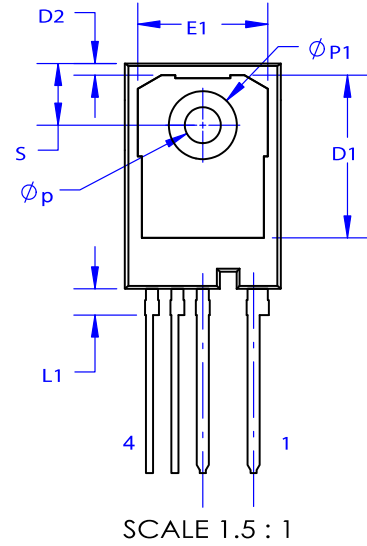
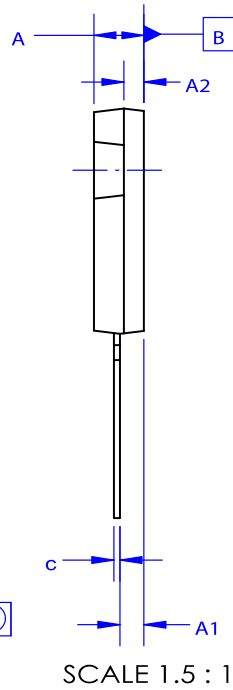
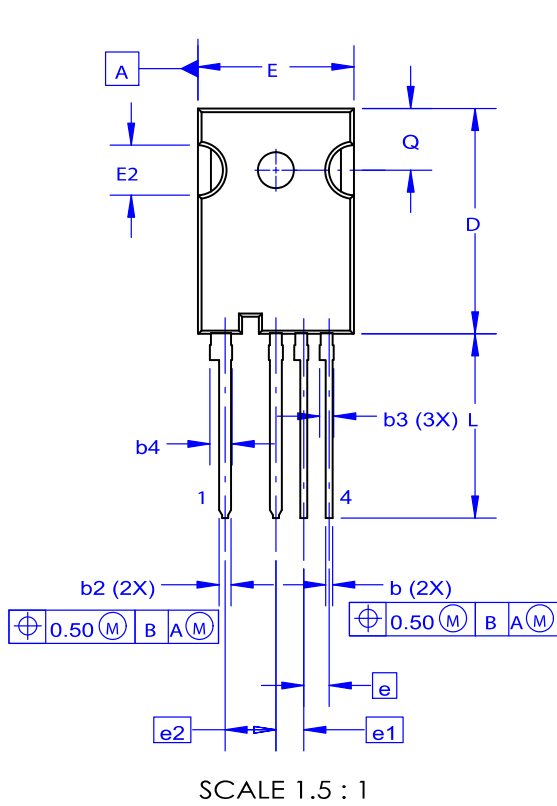

Figure 22. Transient Thermal Impedance of Diode

# FGH75T65SHDTLN4

## PACKAGE DIMENSIONS

TO-247 4-LEAD, THIN LEADS  
CASE 340CW  
ISSUE O



DIM	MILLIMETERS		
	MIN	NOM	MAX
A	4.80	5.00	5.20
A1	1.90	2.40	2.90
A2	1.80	2.00	2.20
b	0.57	0.70	0.83
b2	1.07	1.20	1.33
b3	1.20	1.40	1.60
b4	2.02	2.22	2.42
c	0.50	0.60	0.70
D	22.34	22.54	22.74
D1	16.00	16.30	16.50
D2	0.97	1.17	1.37
e		2.54	
e1		2.79	
e2		5.08	
E	15.40	15.60	15.80
E1	12.80	13.00	13.20
E2	4.80	5.00	5.20
L	18.12	18.42	18.72
L1	2.42	2.62	2.82
Øp	3.40	3.60	3.80
ØP1	6.60	6.80	7.00
Q	5.97	6.17	6.37
S	5.97	6.17	6.37

### NOTES:

- A. NO INDUSTRY STANDARD APPLIES TO THIS PACKAGE.
- B. DIMENSIONS ARE EXCLUSIVE OF BURRS, MOLD FLASH AND TIE BAR EXTRUSIONS.
- C. ALL DIMENSIONS ARE IN MILLIMETERS.



# FGH75T65SHDTLN4

ON Semiconductor and  are trademarks of Semiconductor Components Industries, LLC dba ON Semiconductor or its subsidiaries in the United States and/or other countries. ON Semiconductor owns the rights to a number of patents, trademarks, copyrights, trade secrets, and other intellectual property. A listing of ON Semiconductor's product/patent coverage may be accessed at [www.onsemi.com/site/pdf/Patent-Marking.pdf](http://www.onsemi.com/site/pdf/Patent-Marking.pdf). ON Semiconductor reserves the right to make changes without further notice to any products herein. ON Semiconductor makes no warranty, representation or guarantee regarding the suitability of its products for any particular purpose, nor does ON Semiconductor assume any liability arising out of the application or use of any product or circuit, and specifically disclaims any and all liability, including without limitation special, consequential or incidental damages. Buyer is responsible for its products and applications using ON Semiconductor products, including compliance with all laws, regulations and safety requirements or standards, regardless of any support or applications information provided by ON Semiconductor. "Typical" parameters which may be provided in ON Semiconductor data sheets and/or specifications can and do vary in different applications and actual performance may vary over time. All operating parameters, including "Typicals" must be validated for each customer application by customer's technical experts. ON Semiconductor does not convey any license under its patent rights nor the rights of others. ON Semiconductor products are not designed, intended, or authorized for use as a critical component in life support systems or any FDA Class 3 medical devices or medical devices with a same or similar classification in a foreign jurisdiction or any devices intended for implantation in the human body. Should Buyer purchase or use ON Semiconductor products for any such unintended or unauthorized application, Buyer shall indemnify and hold ON Semiconductor and its officers, employees, subsidiaries, affiliates, and distributors harmless against all claims, costs, damages, and expenses, and reasonable attorney fees arising out of, directly or indirectly, any claim of personal injury or death associated with such unintended or unauthorized use, even if such claim alleges that ON Semiconductor was negligent regarding the design or manufacture of the part. ON Semiconductor is an Equal Opportunity/Affirmative Action Employer. This literature is subject to all applicable copyright laws and is not for resale in any manner.

## PUBLICATION ORDERING INFORMATION

### LITERATURE FULFILLMENT:

Literature Distribution Center for ON Semiconductor  
19521 E. 32nd Pkwy, Aurora, Colorado 80011 USA  
**Phone:** 303-675-2175 or 800-344-3860 Toll Free USA/Canada  
**Fax:** 303-675-2176 or 800-344-3867 Toll Free USA/Canada  
**Email:** [orderlit@onsemi.com](mailto:orderlit@onsemi.com)

**N. American Technical Support:** 800-282-9855 Toll Free  
USA/Canada  
**Europe, Middle East and Africa Technical Support:**  
Phone: 421 33 790 2910

**ON Semiconductor Website:** [www.onsemi.com](http://www.onsemi.com)

**Order Literature:** <http://www.onsemi.com/orderlit>

For additional information, please contact your local  
Sales Representative

Компания «Океан Электроники» предлагает заключение долгосрочных отношений при поставках импортных электронных компонентов на взаимовыгодных условиях!

Наши преимущества:

- Поставка оригинальных импортных электронных компонентов напрямую с производств Америки, Европы и Азии, а так же с крупнейших складов мира;
- Широкая линейка поставок активных и пассивных импортных электронных компонентов (более 30 млн. наименований);
- Поставка сложных, дефицитных, либо снятых с производства позиций;
- Оперативные сроки поставки под заказ (от 5 рабочих дней);
- Экспресс доставка в любую точку России;
- Помощь Конструкторского Отдела и консультации квалифицированных инженеров;
- Техническая поддержка проекта, помощь в подборе аналогов, поставка прототипов;
- Поставка электронных компонентов под контролем ВП;
- Система менеджмента качества сертифицирована по Международному стандарту ISO 9001;
- При необходимости вся продукция военного и аэрокосмического назначения проходит испытания и сертификацию в лаборатории (по согласованию с заказчиком);
- Поставка специализированных компонентов военного и аэрокосмического уровня качества (Xilinx, Altera, Analog Devices, Intersil, Interpoint, Microsemi, Actel, Aeroflex, Peregrine, VPT, Syfer, Eurofarad, Texas Instruments, MS Kennedy, Miteq, Cobham, E2V, MA-COM, Hittite, Mini-Circuits, General Dynamics и др.);

Компания «Океан Электроники» является официальным дистрибьютором и эксклюзивным представителем в России одного из крупнейших производителей разъемов военного и аэрокосмического назначения «JONHON», а так же официальным дистрибьютором и эксклюзивным представителем в России производителя высокотехнологичных и надежных решений для передачи СВЧ сигналов «FORSTAR».



## JONHON

«JONHON» (основан в 1970 г.)

Разъемы специального, военного и аэрокосмического назначения:

(Применяются в военной, авиационной, аэрокосмической, морской, железнодорожной, горно- и нефтедобывающей отраслях промышленности)

«FORSTAR» (основан в 1998 г.)

ВЧ соединители, коаксиальные кабели, кабельные сборки и микроволновые компоненты:

(Применяются в телекоммуникациях гражданского и специального назначения, в средствах связи, РЛС, а так же военной, авиационной и аэрокосмической отраслях промышленности).



Телефон: 8 (812) 309-75-97 (многоканальный)

Факс: 8 (812) 320-03-32

Электронная почта: [ocean@oceanchips.ru](mailto:ocean@oceanchips.ru)

Web: <http://oceanchips.ru/>

Адрес: 198099, г. Санкт-Петербург, ул. Калинина, д. 2, корп. 4, лит. А