

60 V 100 mA Ultra-low Power Voltage Regulator for Industrial Applications

No. EY-395-190606

OVERVIEW

The R1560x is a CMOS-based ultra-low power voltage regulator featuring 60 V input voltage and 100 mA output current. The device includes a short current limit circuit, an overcurrent protection circuit and a thermal shutdown. These features make the R1560x an ideal constant voltage power source for industrial applications. This is a high-reliability semiconductor device for industrial applications (-Y) that has passed both the screening at high temperature and the reliability test with extended hours. This line of products operate in a wide temperature range from low temperature to high temperature to support harsh environment applications.

KEY BENEFITS

- Supply current is as low as Typ. 3.0 μ A, which can reduce current consumption at a system stop.
- The input voltage range is as wide as 5.5 V to 60 V, and the output voltage accuracy is as high as $\pm 0.8\%$.
- High heat dissipation and space-saving HSOP-6J and TO-252-5-P2 packages.

KEY SPECIFICATIONS

- Input Voltage Range (Max. Rating): 5.5 V to 60 V (80 V)
- Operating Temperature Range: -50°C to 125°C
- Supply Current: Typ. 3.0 μ A
- Dropout Voltage: Typ. 1.5 V
($I_{\text{OUT}} = 100 \text{ mA}$, $V_{\text{OUT}} = 5.0 \text{ V}$)
- Output Voltage Accuracy: $\pm 0.8\%$ ($T_a = 25^{\circ}\text{C}$)
- Temp. Coefficient of Output Voltage: Typ. $\pm 100 \text{ ppm}/^{\circ}\text{C}$
- Line Regulation: Typ. 0.01%/V ($6 \text{ V} \leq V_{\text{IN}} \leq 60 \text{ V}$)
- Short-circuit Current Limiting: limits to Typ. 50 mA
- Overcurrent Protection: triggers at Typ. 150 mA
- Thermal Shutdown: triggers at Typ. 165°C

SELECTION GUIDE

Product Name	Package
R1560Sxx1B-E2-YE	HSOP-6J
R1560Jxx1B-T1-YE	TO-252-5-P2

xx: Set Output Voltage (V_{SET})

1.8 V (18) / 2.5 V (25) / 2.8 V (28) / 3.0 V (30) / 3.3 V (33) / 3.4 V (34) / 5.0 V (50) / 7.0 V (70) / 8.0 V (80) / 9.0 V (90) / 10.0 V (A0) / 12.0 V (C0) / 14.0 V (E0)

TYPICAL APPLICATIONS

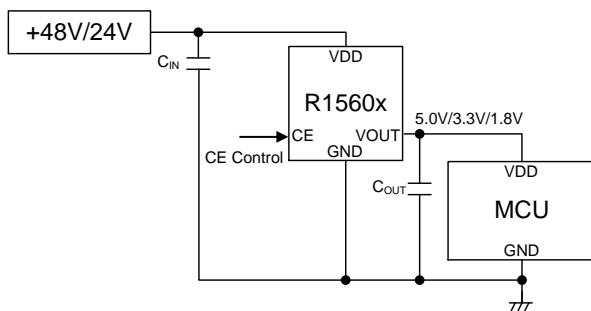

PACKAGES

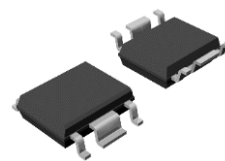

HSOP-6J
5.02 x 6.0 x 1.5 (mm)

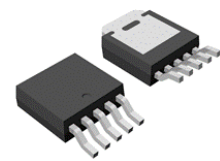

TO-252-5-P2
6.6 x 9.9 x 2.3 (mm)

APPLICATIONS

- FA Equipment, Smart meters
- Surveillance Cameras and Vending Machines that are used under high-temperature conditions

R1560x-Y

No. EY-395-190606

SELECTION GUIDE

The output voltage and the package type are user-selectable options.

Selection Guide

Product Name	Package	Quantity per Reel	Pb Free	Halogen Free
R1560Sxx1B-E2-YE	HSOP-6J	1,000 pcs	Yes	Yes
R1560Jxx1B-T1-YE	TO-252-5-P2	3,000 pcs	Yes	Yes

xx: Set Output Voltage (V_{SET})

1.8 V (18) / 2.5 V (25) / 2.8 V (28) / 3.0 V (30) / 3.3 V (33) / 3.4 V (34) / 5.0 V (50) /
7.0 V (70) / 8.0 V (80) / 9.0 V (90) / 10.0 V (A0) / 12.0 V (C0) / 14.0 V (E0)

BLOCK DIAGRAM

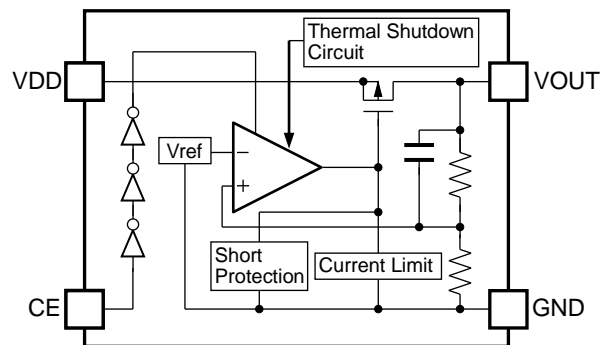

R1560x Block Diagram

PIN DESCRIPTIONS

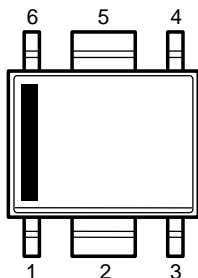

HSOP-6J Pin Configuration

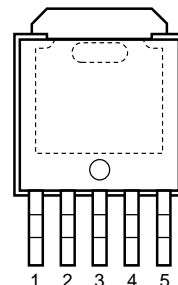

TO-252-5-P2 Pin Configuration

HSOP-6J Pin Description

Pin No.	Pin Name	Description
1	VOUT	Output Pin
2	GND ⁽¹⁾	Ground Pin
3	CE	Chip Enable Pin, Active-high
4	GND ⁽¹⁾	Ground Pin
5	GND ⁽¹⁾	Ground Pin
6	VDD	Input Pin

TO-252-5-P2 Pin Description

Pin No.	Pin Name	Description
1	VDD	Input Pin
2	NC	No Connection
3	GND	Ground Pin
4	VOUT	Output Pin
5	CE	Chip Enable Pin, Active-high

Pin Equivalent Circuit Diagrams

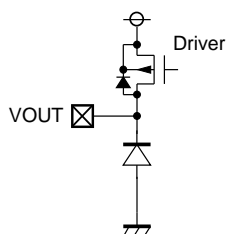

VOUT Pin Equivalent Circuit Diagram

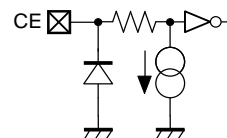

CE Pin Equivalent Circuit Diagram

⁽¹⁾ The GND pins are connected to each other on the board.

R1560x-Y

No. EY-395-190606

ABSOLUTE MAXIMUM RATINGS

Absolute Maximum Ratings

Symbol	Parameter		Rating	Unit	
V_{IN}	Input Voltage		-0.3 to 80	V	
V_{IN}	Peak Inrush Voltage ⁽¹⁾		90	V	
V_{CE}	CE Pin Input Voltage		-0.3 to 80	V	
V_{OUT}	Output Voltage		-0.3 to $V_{IN} + 0.3 \leq 80$	V	
I_{OUT}	Output Current		150	mA	
P_D	Power Dissipation ⁽²⁾	HSOP-6J	JEDEC STD.51-7	3400	mW
		TO-252-5-P2	JEDEC STD.51-7	4800	
T_j	Junction Temperature		-50 to 150	°C	
T_{stg}	Storage Temperature Range		-55 to 150	°C	

ABSOLUTE MAXIMUM RATINGS

Electronic and mechanical stress momentarily exceeded absolute maximum ratings may cause permanent damage and may degrade the life time and safety for both device and system using the device in the field. The functional operation at or over these absolute maximum ratings is not assured.

RECOMMENDED OPERATING CONDITIONS

Recommended Operating Conditions

Symbol	Parameter	Rating	Unit
V_{IN}	Input Voltage	5.5 to 60	V
T_a	Operating Temperature Range	-50 to 125	°C

RECOMMENDED OPERATING CONDITONS

All of electronic equipment should be designed that the mounted semiconductor devices operate within the recommended operating conditions. The semiconductor devices cannot operate normally over the recommended operating conditions, even if they are used over such conditions by momentary electronic noise or surge. And the semiconductor devices may receive serious damage when they continue to operate over the recommended operating conditions.

⁽¹⁾ Duration: 200 ms or less

⁽²⁾ Refer to *POWER DISSIPATION* for detailed information.

ELECTRICAL CHARACTERISTICS

$C_{IN} = 0.1 \mu\text{F}$ / $C_{OUT} = 0.1 \mu\text{F}$, unless otherwise noted.

The specifications surrounded by are guaranteed by design engineering at $-50^\circ\text{C} \leq T_a \leq 125^\circ\text{C}$.

R1560x Electrical Characteristics

($T_a = 25^\circ\text{C}$)

Symbol	Parameter	Test Conditions/Comments	Min.	Typ.	Max.	Unit	
I _{SS}	Supply Current	$V_{IN} = 14 \text{ V}$ $V_{CE} = 14 \text{ V}$ $I_{OUT} = 0 \text{ mA}$	$V_{SET} \leq 5.0 \text{ V}$		3.0	8.0	μA
		$V_{IN} = 18 \text{ V}$ $V_{CE} = 18 \text{ V}$ $I_{OUT} = 0 \text{ mA}$	$V_{SET} > 5.0 \text{ V}$		3.5	12	
I _{standby}	Standby Current	$V_{IN} = 60 \text{ V}, V_{CE} = 0 \text{ V}$			0.1	2.0	μA
V _{OUT}	Output Voltage	$V_{SET} \leq 5.0 \text{ V}$ $V_{IN} = 14 \text{ V}$ $I_{OUT} = 1 \text{ mA}$	$T_a = 25^\circ\text{C}$	$\times 0.992$		$\times 1.008$	V
			$-50^\circ\text{C} \leq T_a \leq 125^\circ\text{C}$	$\times 0.985$		$\times 1.015$	
		$V_{SET} > 5.0 \text{ V}$ $V_{IN} = 18 \text{ V}$ $I_{OUT} = 1 \text{ mA}$	$T_a = 25^\circ\text{C}$	$\times 0.988$		$\times 1.012$	
			$-50^\circ\text{C} \leq T_a \leq 125^\circ\text{C}$	$\times 0.980$		$\times 1.020$	
$\Delta V_{OUT} / \Delta I_{OUT}$	Load Regulation	$V_{IN} = 8 \text{ V} (V_{SET} \leq 5.0 \text{ V})$ $V_{IN} = V_{SET} + 3 \text{ V} (V_{SET} > 5.0 \text{ V})$ $1 \text{ mA} \leq I_{OUT} \leq 100 \text{ mA}$		Refer to Voltage-specific Electrical Characteristics			
$\Delta V_{OUT} / \Delta V_{IN}$	Line Regulation	$6 \text{ V} \leq V_{IN} \leq 60 \text{ V}$ $I_{OUT} = 1 \text{ mA}$	$V_{SET} \leq 5.0 \text{ V}$	-0.02	0.01	0.02	%/V
		$V_{SET} + 1 \text{ V} \leq V_{IN} \leq 60 \text{ V}$ $I_{OUT} = 1 \text{ mA}$	$V_{SET} > 5.0 \text{ V}$	-0.06	0.03	0.06	
V _{DIF}	Dropout Voltage	$I_{OUT} = 100 \text{ mA}$		Refer to Voltage-specific Electrical Characteristics			
I _{LIM}	Output Current Limit	$V_{IN} = 8.0 \text{ V} (V_{SET} \leq 5.0 \text{ V})$ $V_{IN} = V_{SET} + 3 \text{ V} (V_{SET} > 5.0 \text{ V})$		100	150	250	mA
I _{SC}	Short-circuit Current	$V_{IN} = 8.0 \text{ V} (V_{SET} \leq 5.0 \text{ V})$ $V_{IN} = V_{SET} + 3 \text{ V} (V_{SET} > 5.0 \text{ V})$ $V_{OUT} = 0 \text{ V}$		20	50	75	mA
V _{CEH}	CE Input Voltage "H"	$V_{IN} = 60 \text{ V}$		3.0		60	V
V _{CEL}	CE Input Voltage "L"	$V_{IN} = 60 \text{ V}$		0		0.3	V
I _{PD}	CE Pull-down Current	$V_{IN} = 60 \text{ V}, V_{CE} = 3 \text{ V}$			0.4	0.8	μA
T _{TSD}	Thermal Shutdown Temperature	Junction Temperature		150	165		$^\circ\text{C}$
T _{TSR}	Thermal Shutdown Release Temperature ⁽¹⁾	Junction Temperature		125	135		$^\circ\text{C}$

All parameters are tested under the pulse load condition ($T_j \approx T_a = 25^\circ\text{C}$).

⁽¹⁾ If the VDD and CE pins are turned on at the same time when $T_a > 125^\circ\text{C}$, the thermal shutdown can be activated.

R1560x-Y

No. EY-395-190606

R1560x Product-specific Electrical Characteristics

(Ta = 25°C)

Product Name	V _{OUT} (V) (Ta = 25°C)			V _{OUT} (V) (-50°C ≤ Ta ≤ 125°C)			ΔV _{OUT} /ΔI _{OUT} (mV)			V _{DIF} (V)	
	Min.	Typ.	Max.	Min.	Typ.	Max.	Min.	Typ.	Max.	Typ.	Max.
R1560x181B	1.7856	1.80	1.8144	1.7730	1.80	1.8270	-300	30	300	3.7	4.0
R1560x251B	2.4800	2.50	2.5200	2.4625	2.50	2.5375				3.0	3.6
R1560x281B	2.7776	2.80	2.8224	2.7580	2.80	2.8420				2.7	3.6
R1560x301B	2.9760	3.00	3.0240	2.9550	3.00	3.0450				2.5	3.6
R1560x331B	3.2736	3.30	3.3264	3.2505	3.30	3.3495				2.2	3.0
R1560x341B	3.3728	3.40	3.4272	3.3490	3.40	3.4510				2.1	3.0
R1560x501B	4.9600	5.00	5.0400	4.9250	5.00	5.0750				1.5	3.0
R1560x701B	6.9160	7.00	7.0840	6.8600	7.00	7.1400	-600	60	600	1.5	3.0
R1560x801B	7.9040	8.00	8.0960	7.8400	8.00	8.1600				1.5	3.0
R1560x901B	8.8920	9.00	9.1080	8.8200	9.00	9.1800				1.5	3.0
R1560xA01B	9.8800	10.00	10.120	9.8000	10.0	10.200				1.5	3.0
R1560xC01B	11.856	12.00	12.144	11.760	12.0	12.240				1.5	3.0
R1560xE01B	13.832	14.00	14.168	13.720	14.0	14.280				1.5	3.0

THEORY OF OPERATION

Thermal Shutdown

If the junction temperature increases above 165°C (Typ.), the operation of the regulator would stop. And if the junction temperature decreases below 135°C (Typ.), the operation of the regulator would restart. Unless the causes of temperature rising are removed, the regulator repeats turning on and off and the output waveform becomes a pulse shape.

APPLICATION INFORMATION

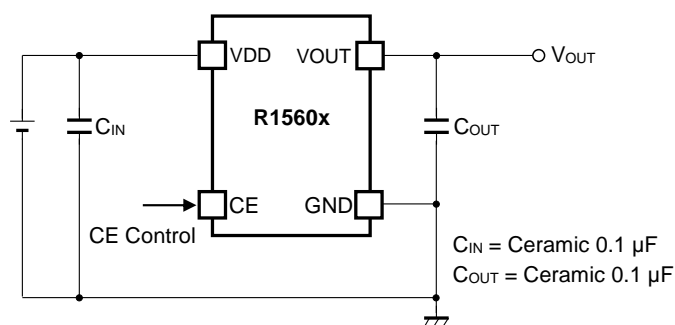

R1560x Typical Applications

Typical Application for IC Chip Breakdown Prevention

When a sudden surge of electrical current travels along the VOUT pin and GND due to a short-circuit, electrical resonance of a circuit involving an output capacitor (C_{OUT}) and a short circuit inductor generates a negative voltage and may damage the device or the load devices. Connecting a schottky diode (D) between the VOUT pin and GND has the effect of preventing damage to them.

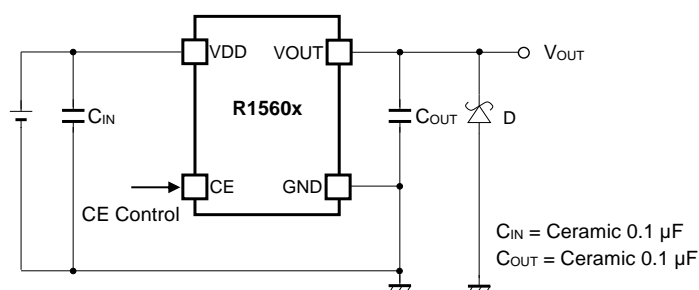

R1560x Typical Application for IC Chip Breakdown Prevention

R1560x-Y

No. EY-395-190606

Equivalent Series Resistance vs. Output Current

It is recommended that a ceramic type capacitor be used for this device. However, other types of capacitors having lower ESR can also be used. The relation between the output current (I_{OUT}) and the ESR of output capacitor is shown below.

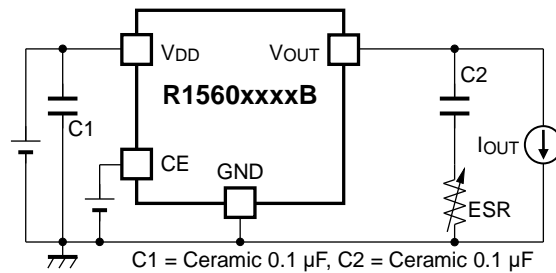

Measurement Conditions

Frequency Band: 10 Hz to 2 MHz

Measurement Temperature: -40°C to 125°C

Capacitor: C1 = Ceramic 0.1 μ F, C2 = Ceramic 0.1 μ F

ESR: 0 to 100 Ω

V_{OUT} : 1.8 V, 5.0 V

It is confirmed that the output noise level is less than the specified value (40 μ Vrms) under the measurement conditions above.

TECHNICAL NOTES

The performance of a power source circuit using this device is highly dependent on a peripheral circuit. A peripheral component or the device mounted on PCB should not exceed its rated voltage, rated current or rated power. When designing a peripheral circuit, please be fully aware of the following points.

Phase Compensation

A phase compensation is provided to secure stable operation even when the load current is varied. For this purpose, use a 0.1- μ F or more output capacitor (C_{OUT}) with good frequency characteristics and proper ESR (Equivalent Series Resistance). In case of using a tantalum type capacitor with a large ESR, the output might become unstable. Evaluate your circuit including consideration of frequency characteristics. Connect a 0.1- μ F or more input capacitor (C_{IN}) between the VDD and GND pins with shortest-distance wiring.

PCB Layout

As for the HSOP-6J package, ensure that the GND pins (Pin No. 2, 4 and 5) are connected to each other and the ground plane.

Operating the Device below the Minimum Operating Voltage

Operating the device below the recommended operating voltage range can make the output voltage unstable and make the output voltage higher than the set output voltage (V_{SET}) of the device.

In the case of turning on the VIN and CE pins at the same time, both pins must be turned on using a 100-V/ms or more slew rate in order to prevent the unstable operation upon start-up. In the case of turning on the VIN pin using a 100-V/ms or less slew rate, the CE pin must be turned on after the supply voltage becomes 5.5 V or more.

In the case of turning off the VIN and CE pins at the same time, both pins must be turned off using a steep slew rate, -100 V/ms or higher in order to prevent the unstable operation. In the case of turning off the VIN pin using a slow rate, lower than -100 V/ms, the CE pin must be turned off before the supply voltage decreases to 5.5 V.

Transient Response

An output ceramic capacitor of $C_{OUT} = 0.1 \mu\text{F}$ prevents R1560x series from phase oscillation to ensure the IC's stable operation. However, variation in input voltage and load current would lead to an unstable output voltage which fails to meet the requirements of the system. Especially, in a high output version: $V_{SET} > 5 \text{ V}$, this results in slow response of the IC and a great variation in output. To avoid this problem, use a ceramic capacitor of $C_{OUT} = 10 \mu\text{F}$ or more to minimize variation in output. Place the capacitor as close as possible to and outside of the IC when the electrolytic capacitor is used as an output line element.

R1560x-Y

No. EY-395-190606

TYPICAL CHARACTERISTICS

Note: Typical Characteristics are intended to be used as reference data; they are not guaranteed.

1) Output Voltage vs. Output Current ($T_a = 25^\circ\text{C}$)

R1560x181B

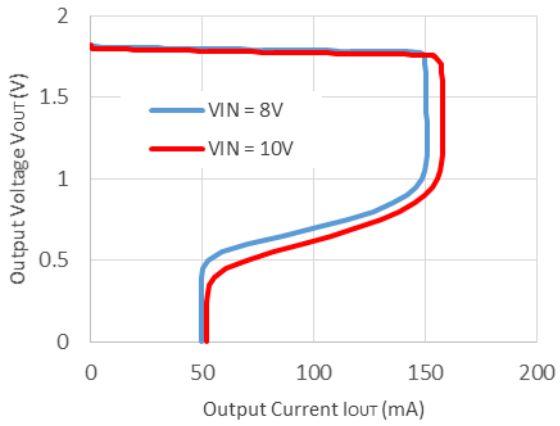

R1560x501B

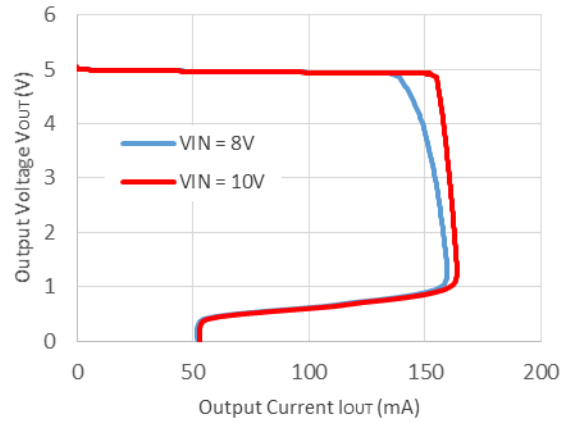

R1560xE01B

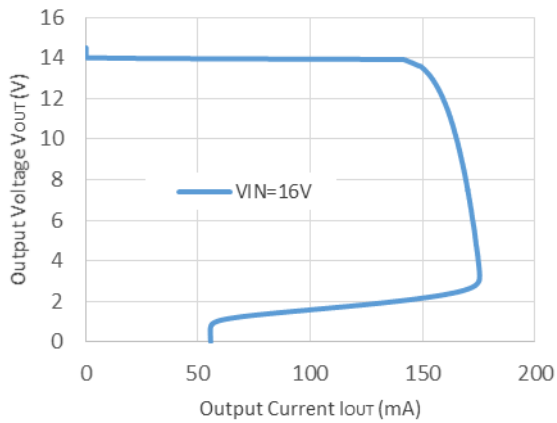

2) Output Voltage vs. Input Voltage (Ta = 25°C)

R1560x181B

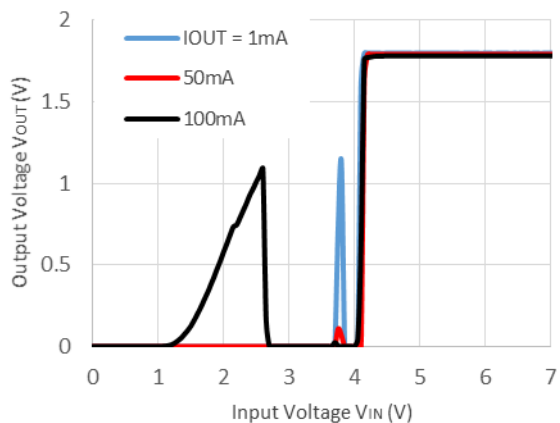

R1560x501B

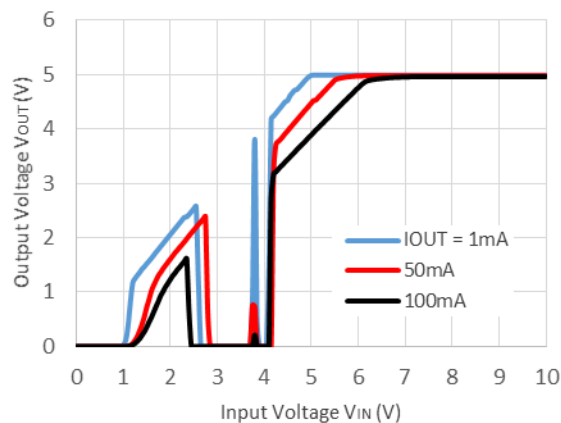

R1560xE01B

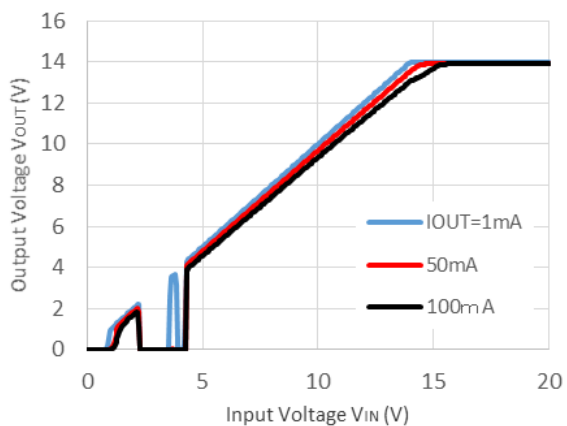

3) Supply Current vs. Temperature

R1560x181B

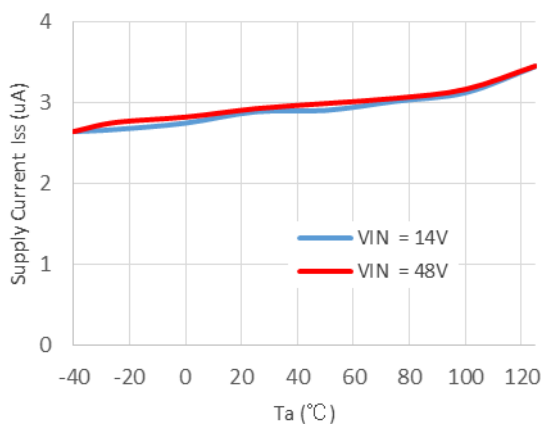

R1560x501B

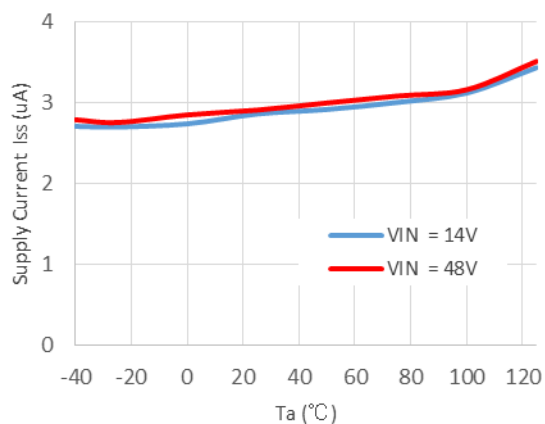

R1560x-Y

No. EY-395-190606

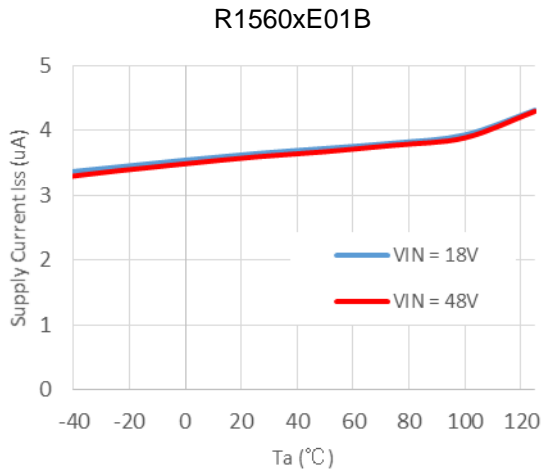

4) Output Voltage vs. Temperature (I_{OUT} = 1 mA)

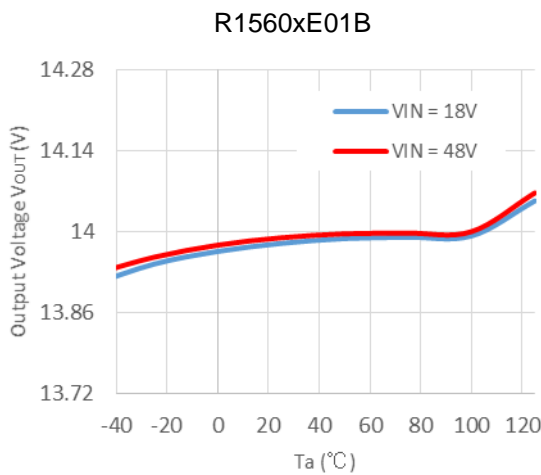
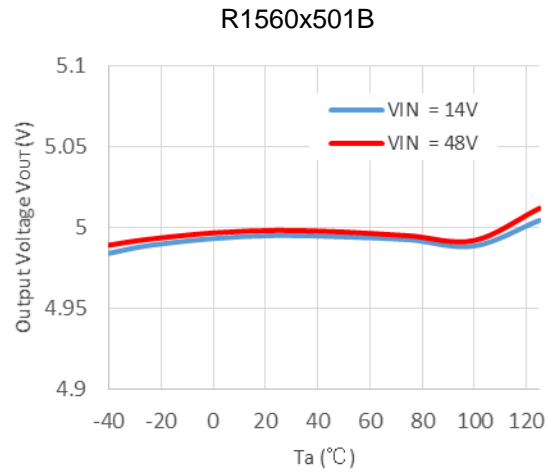
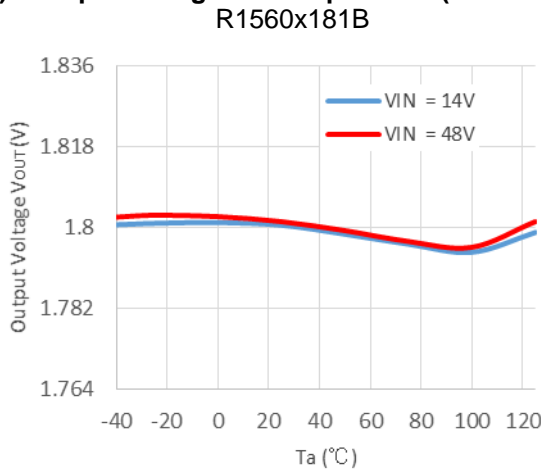

5) Supply Current vs. Input Voltage

R1560x181B

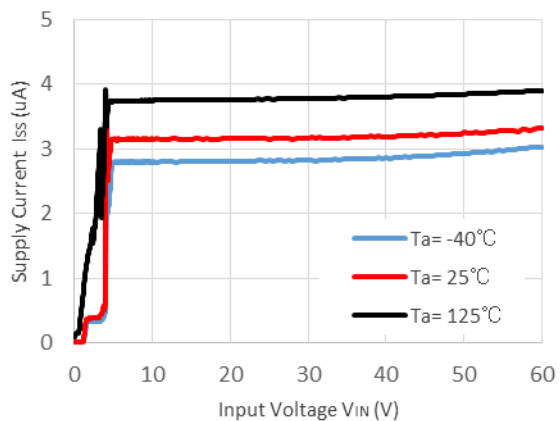

R1560x501B

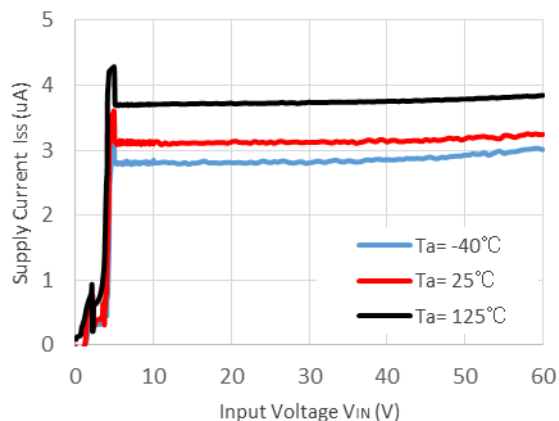

R1560xE01B

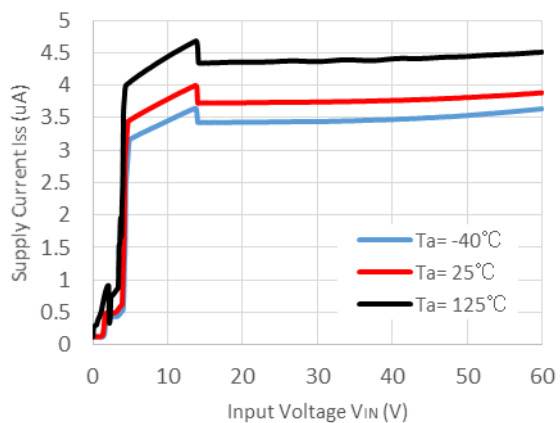

6) Dropout Voltage vs. Output Current

R1560x181B

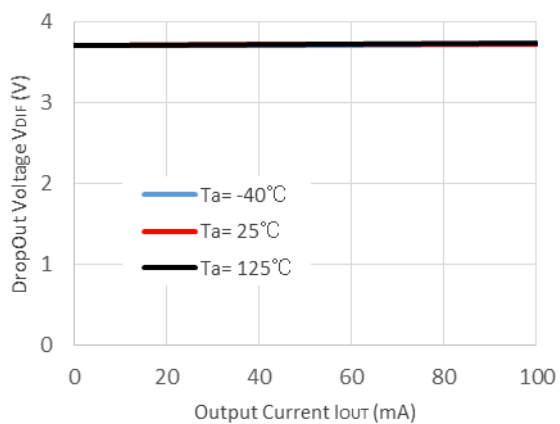

R1560x501B

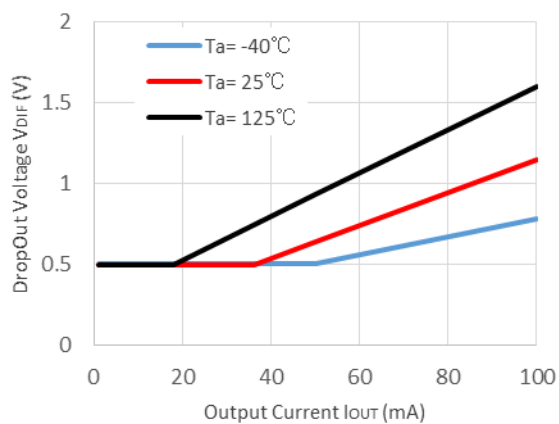

R1560x-Y

No. EY-395-190606

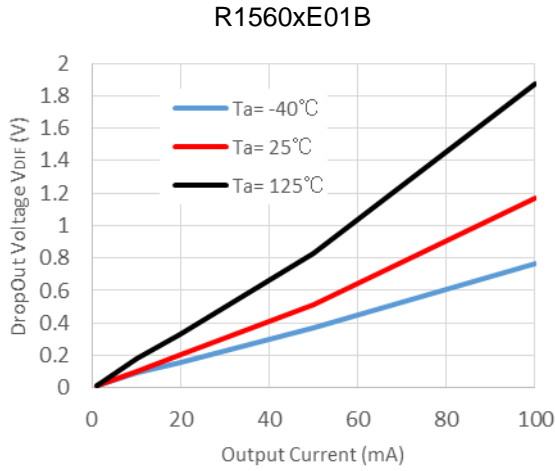

7) Ripple Rejection vs. Input Bias Voltage (Ta = 25°C, V_{RIPPLE} = ± 0.2 V)

R1560x181B

R1560x501B

C_{OUT} = 0.1 μF

C_{OUT} = 0.1 μF

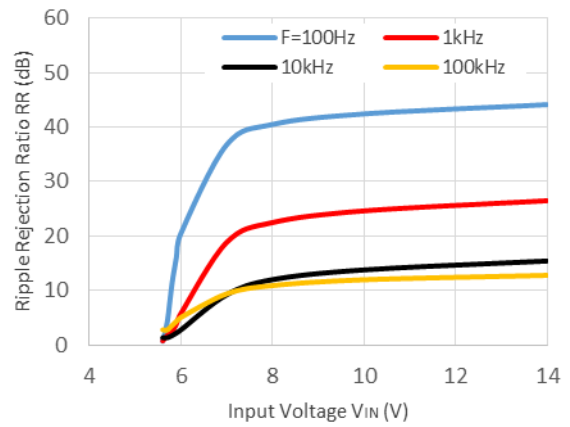
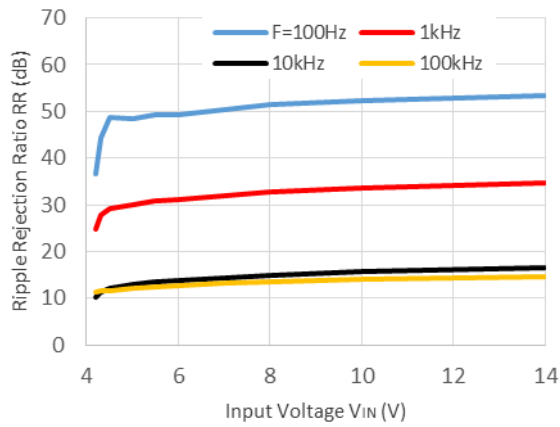

R1560xE01B

C_{OUT} = 10 μF

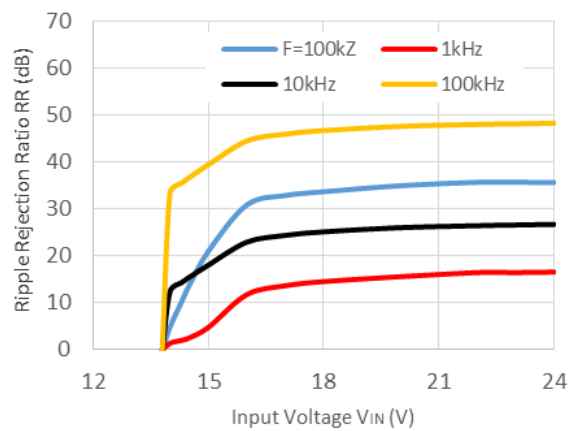

8) Ripple Rejection vs. Frequency (Ta = 25°C)

R1560x181B

V_{IN} = 14 V ± 0.2 V ripple, C_{OUT} = 0.1 μF

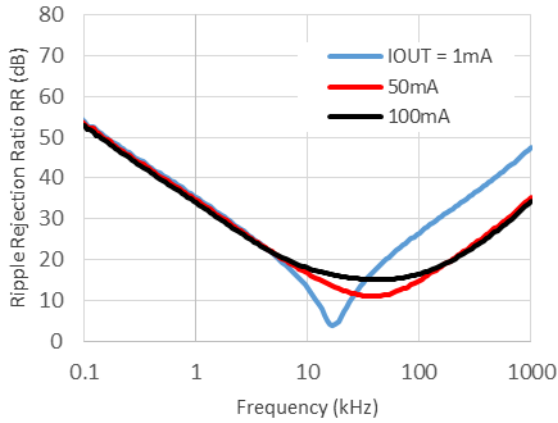

R1560x501B

V_{IN} = 14 V ± 0.2 V ripple, C_{OUT} = 0.1 μF

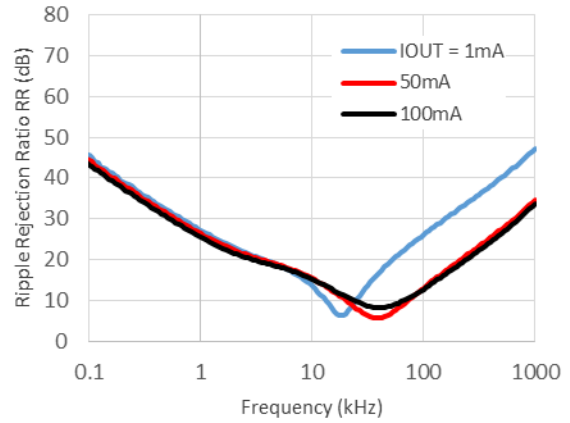

R1560xE01B

V_{IN} = 18 V ± 0.2 V ripple, C_{OUT} = 10 μF

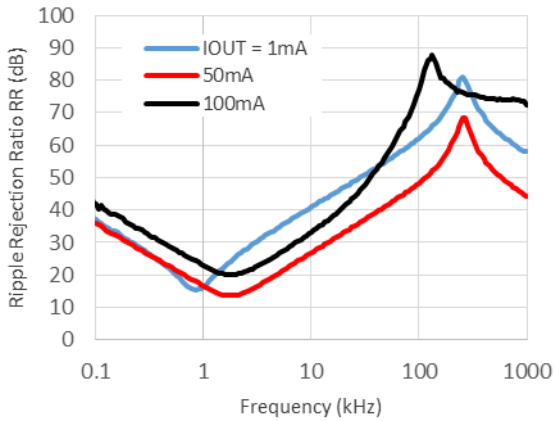

9) Input Transient Response (Ta = 25°C, I_{OUT} = 1 mA)

R1560x181B

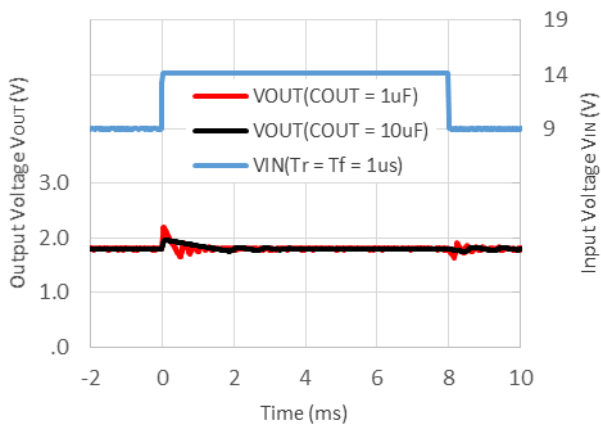

R1560x501B

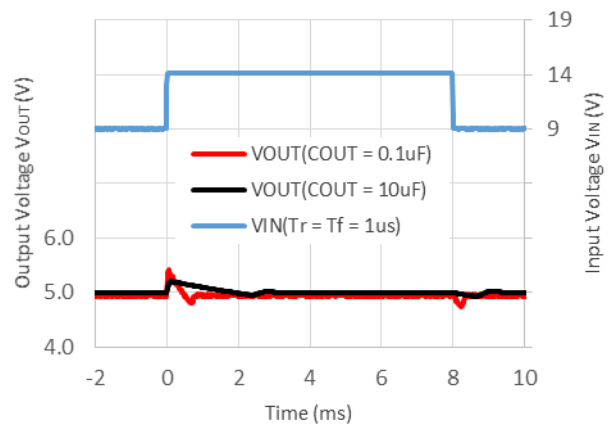

R1560x-Y

No. EY-395-190606

R1560xE01B

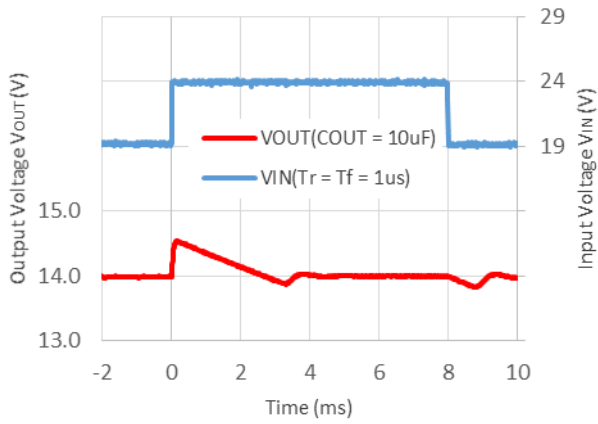

10) Load Dump (Ta = 25°C, Iout = 1 mA)

R1560x181B

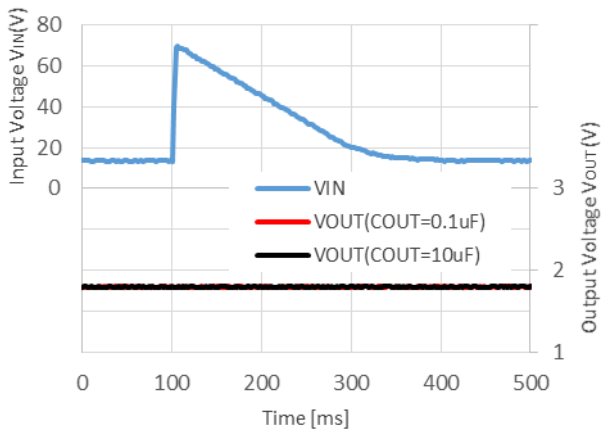

R1560x501B

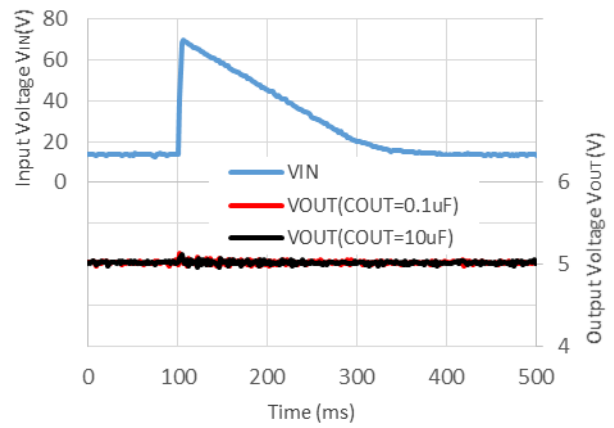

R1560xE01B

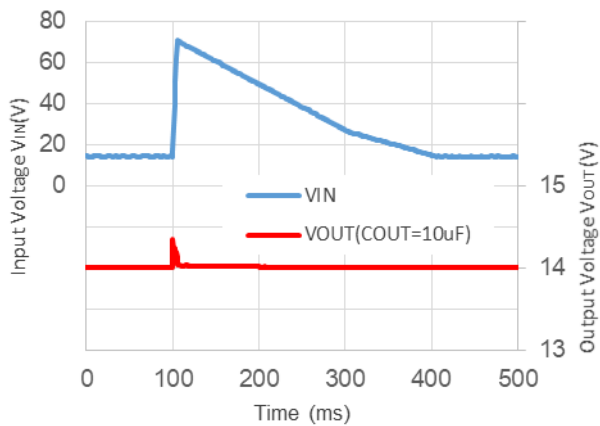

11) Load Transient Response ($T_a = 25^\circ\text{C}$, $I_{OUT} = 1\text{ mA} \leftrightarrow 20\text{ mA}$)

R1560x181B

$V_{IN} = 14\text{ V}$, $I_{OUT} = 1\text{ mA} \rightarrow 20\text{ mA}$

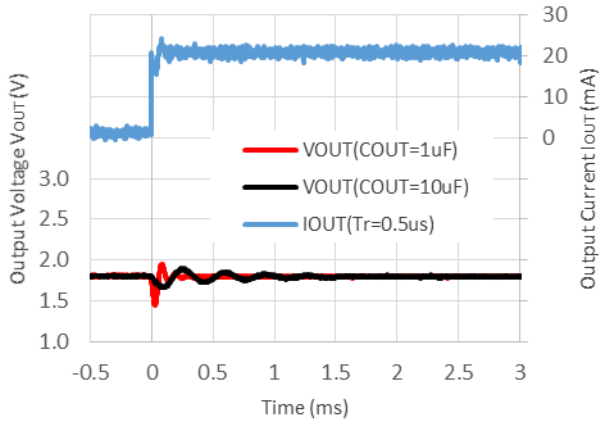

R1560x181B

$V_{IN} = 14\text{ V}$, $I_{OUT} = 20\text{ mA} \rightarrow 1\text{ mA}$

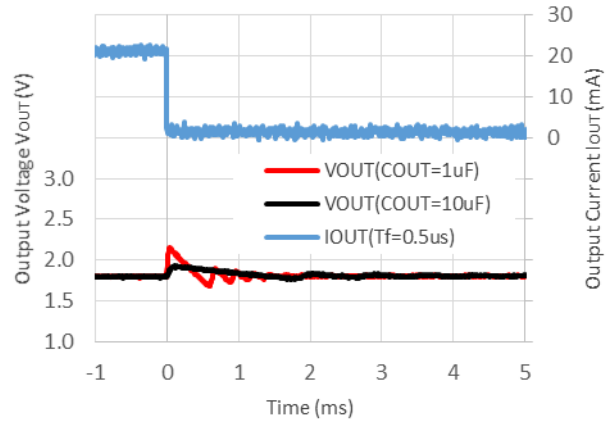

R1560x501B

$V_{IN} = 14\text{ V}$, $I_{OUT} = 1\text{ mA} \rightarrow 20\text{ mA}$

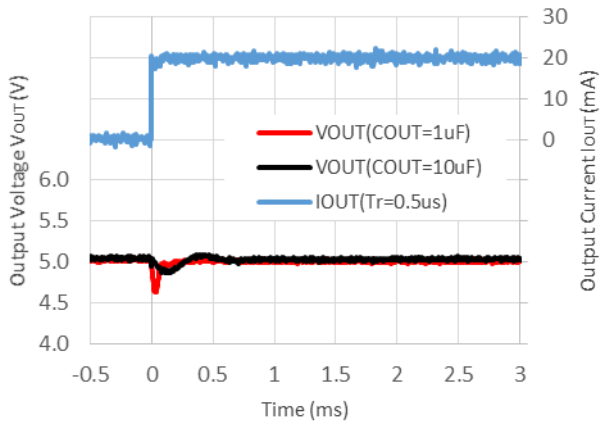

R1560x501B

$V_{IN} = 14\text{ V}$, $I_{OUT} = 20\text{ mA} \rightarrow 1\text{ mA}$

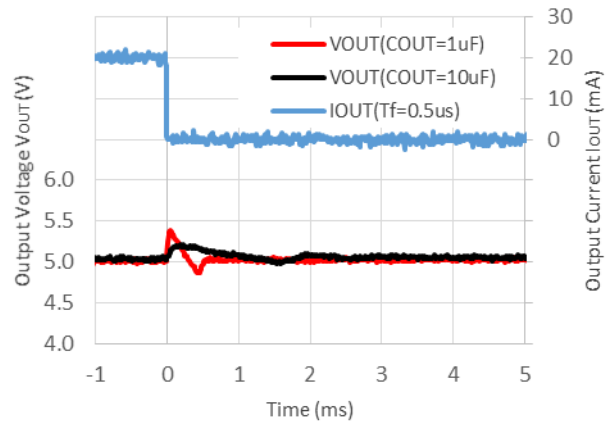

R1560xE01B

$V_{IN} = 18\text{ V}$, $I_{OUT} = 1\text{ mA} \rightarrow 20\text{ mA}$

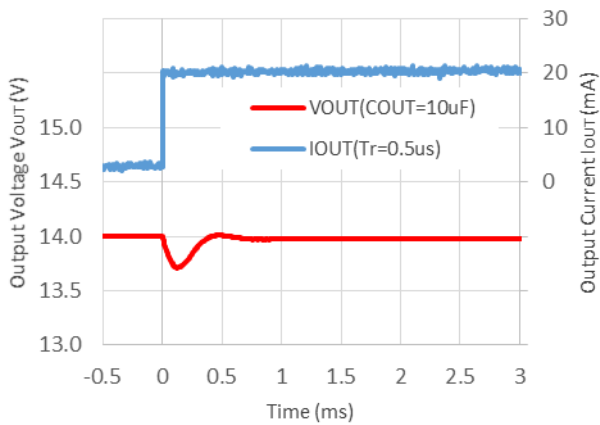

R1560xE01B

$V_{IN} = 18\text{ V}$, $I_{OUT} = 20\text{ mA} \rightarrow 1\text{ mA}$

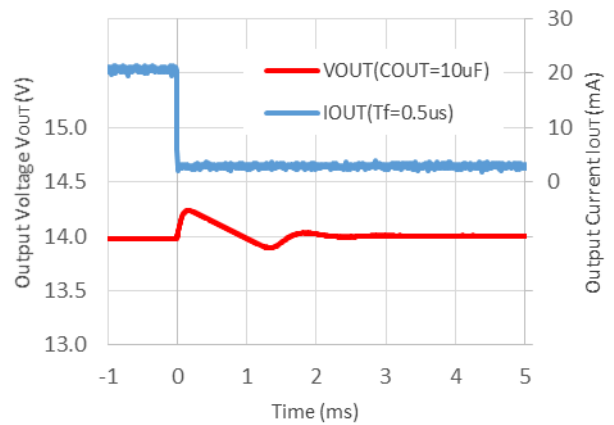

R1560x-Y

No. EY-395-190606

12) CE Start-up ($T_a = 25^\circ\text{C}$)

R1560x181B

$V_{IN} = 14\text{ V}$, $C_{OUT} = 0.1\ \mu\text{F}$

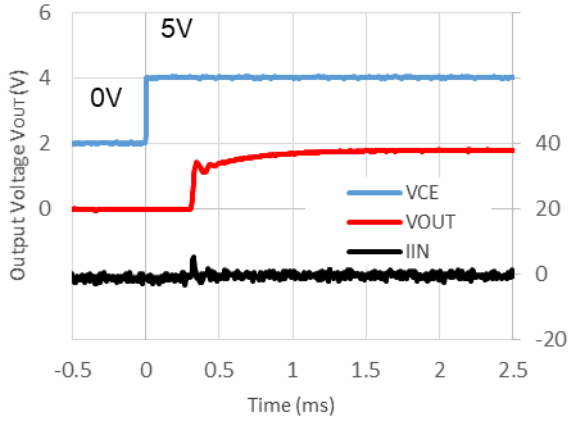

R1560x181B

$V_{IN} = 14\text{ V}$, $C_{OUT} = 10\ \mu\text{F}$

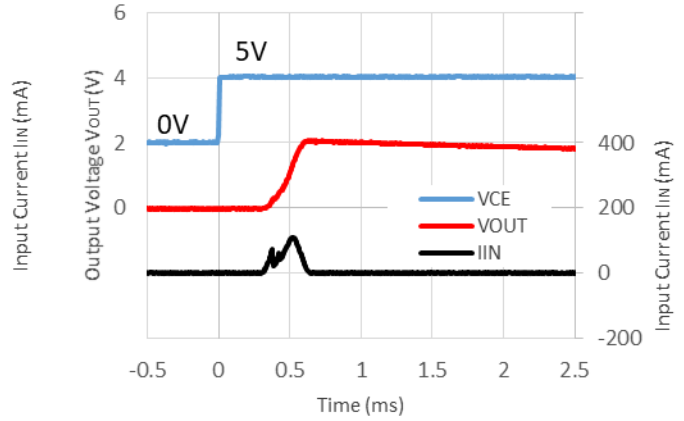

R1560x501B

$V_{IN} = 14\text{ V}$, $C_{OUT} = 0.1\ \mu\text{F}$

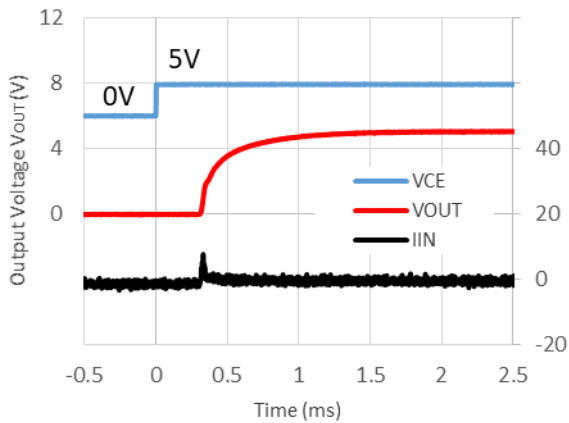

R1560x501B

$V_{IN} = 14\text{ V}$, $C_{OUT} = 10\ \mu\text{F}$

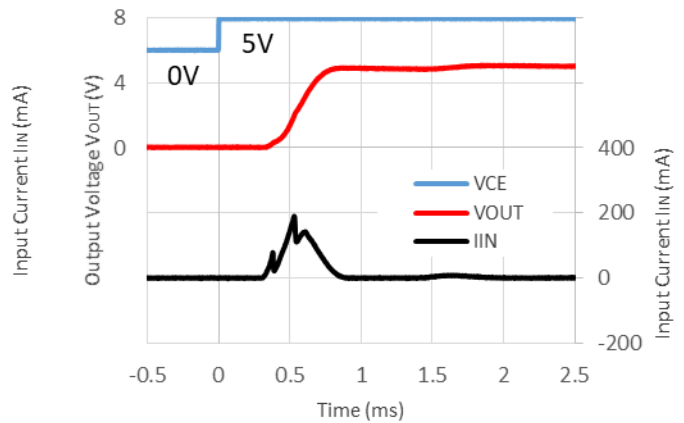

R1560xE01B

$V_{IN} = 18\text{ V}$, $C_{OUT} = 10\ \mu\text{F}$

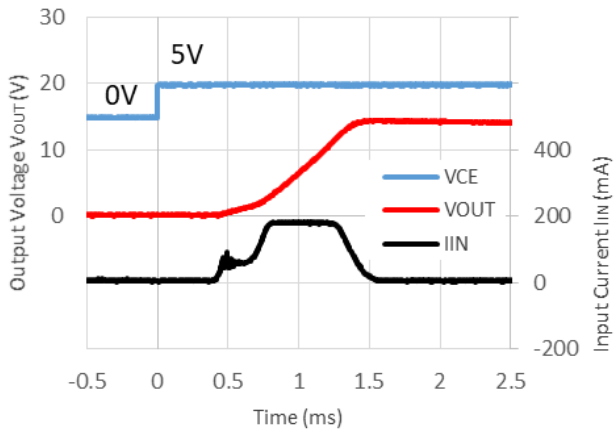

The power dissipation of the package is dependent on PCB material, layout, and environmental conditions. The following measurement conditions are based on JEDEC STD. 51-7.

Measurement Conditions

Item	Measurement Conditions
Environment	Mounting on Board (Wind Velocity = 0 m/s)
Board Material	Glass Cloth Epoxy Plastic (Four-Layer Board)
Board Dimensions	76.2 mm × 114.3 mm × 0.8 mm
Copper Ratio	Outer Layer (First Layer): Less than 95% of 50 mm Square Inner Layers (Second and Third Layers): Approx. 100% of 50 mm Square Outer Layer (Fourth Layer): Approx. 100% of 50 mm Square
Through-holes	φ 0.3 mm × 28 pcs

Measurement Result

(Ta = 25°C, Tjmax = 150°C)

Item	Measurement Result
Power Dissipation	3400 mW
Thermal Resistance (θ_{ja})	$\theta_{ja} = 37^{\circ}\text{C/W}$
Thermal Characterization Parameter (ψ_{jt})	$\psi_{jt} = 7^{\circ}\text{C/W}$

θ_{ja} : Junction-to-Ambient Thermal Resistance

ψ_{jt} : Junction-to-Top Thermal Characterization Parameter

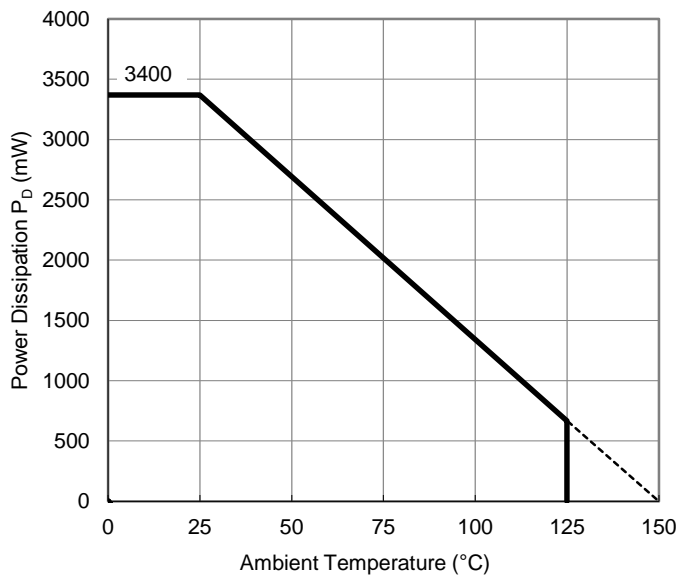

Power Dissipation vs. Ambient Temperature

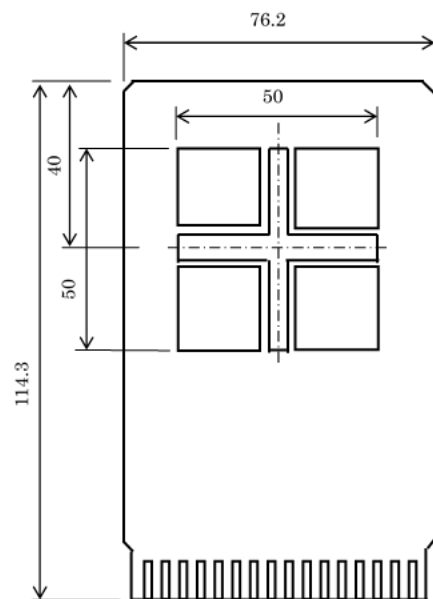

Measurement Board Pattern

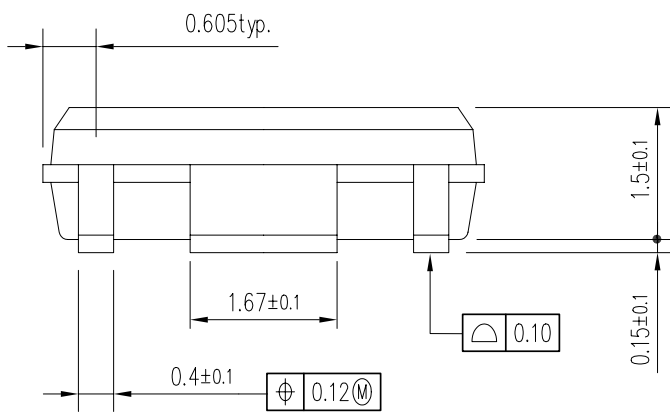
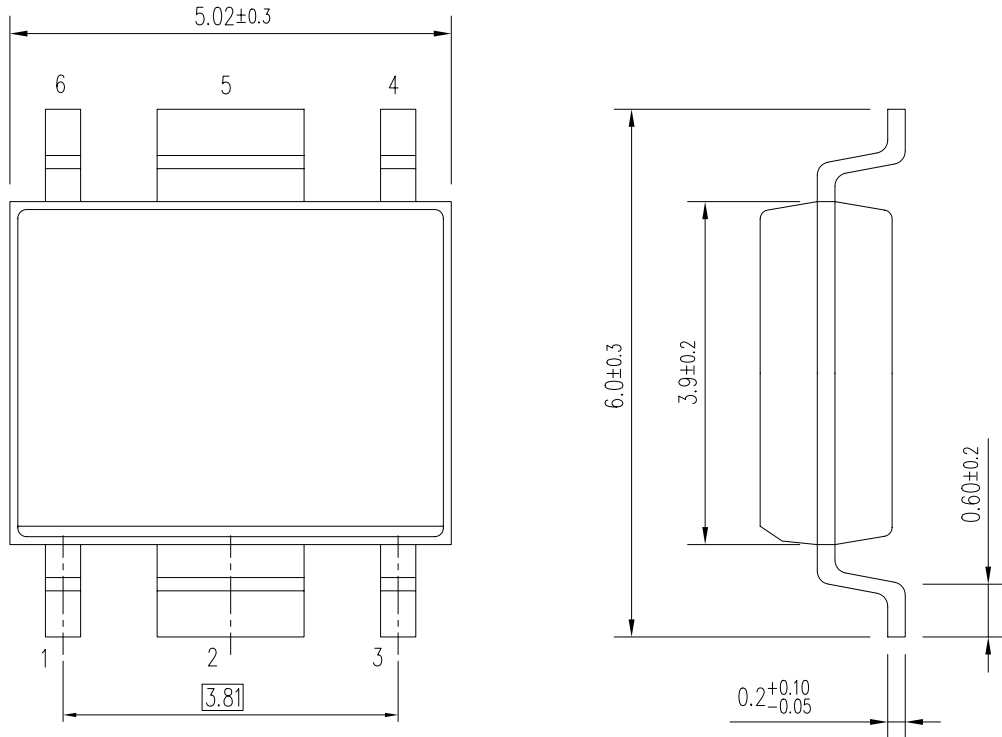

UNIT: mm

HSOP-6J Package Dimensions

The power dissipation of the package is dependent on PCB material, layout, and environmental conditions. The following measurement conditions are based on JEDEC STD. 51-7.

Measurement Conditions

Item	Measurement Conditions
Environment	Mounting on Board (Wind Velocity = 0 m/s)
Board Material	Glass Cloth Epoxy Plastic (Four-Layer Board)
Board Dimensions	76.2 mm × 114.3 mm × 0.8 mm
Copper Ratio	Outer Layer (First Layer): Less than 95% of 50 mm Square Inner Layers (2nd, 3rd, 4th Layers: Approx. 100% of 50 mm Square
Through-holes	φ 0.3 mm × 21 pcs

Measurement Result

(Ta = 25°C, Tjmax = 150°C)

Item	Measurement Result
Power Dissipation	4800 mW
Thermal Resistance (θ_{ja})	$\theta_{ja} = 26^{\circ}\text{C/W}$
Thermal Characterization Parameter (ψ_{jt})	$\psi_{jt} = 7^{\circ}\text{C/W}$

θ_{ja} : Junction-to-Ambient Thermal Resistance

ψ_{jt} : Junction-to-Top Thermal Characterization Parameter

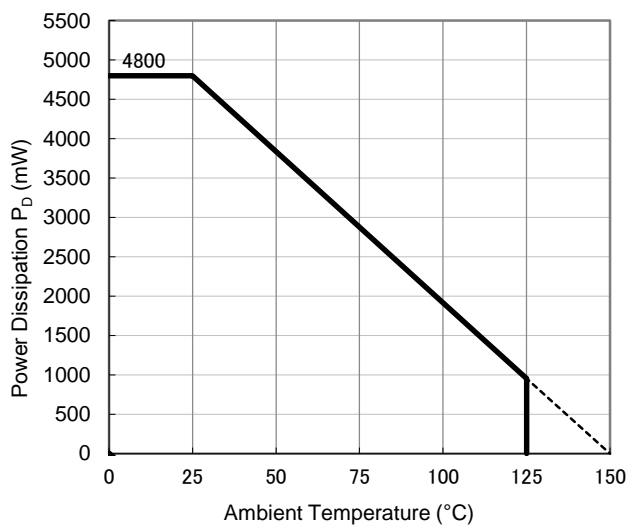

Power Dissipation vs. Ambient Temperature

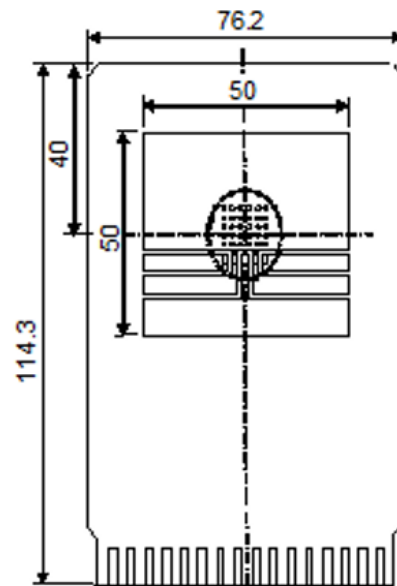

Measurement Board Pattern

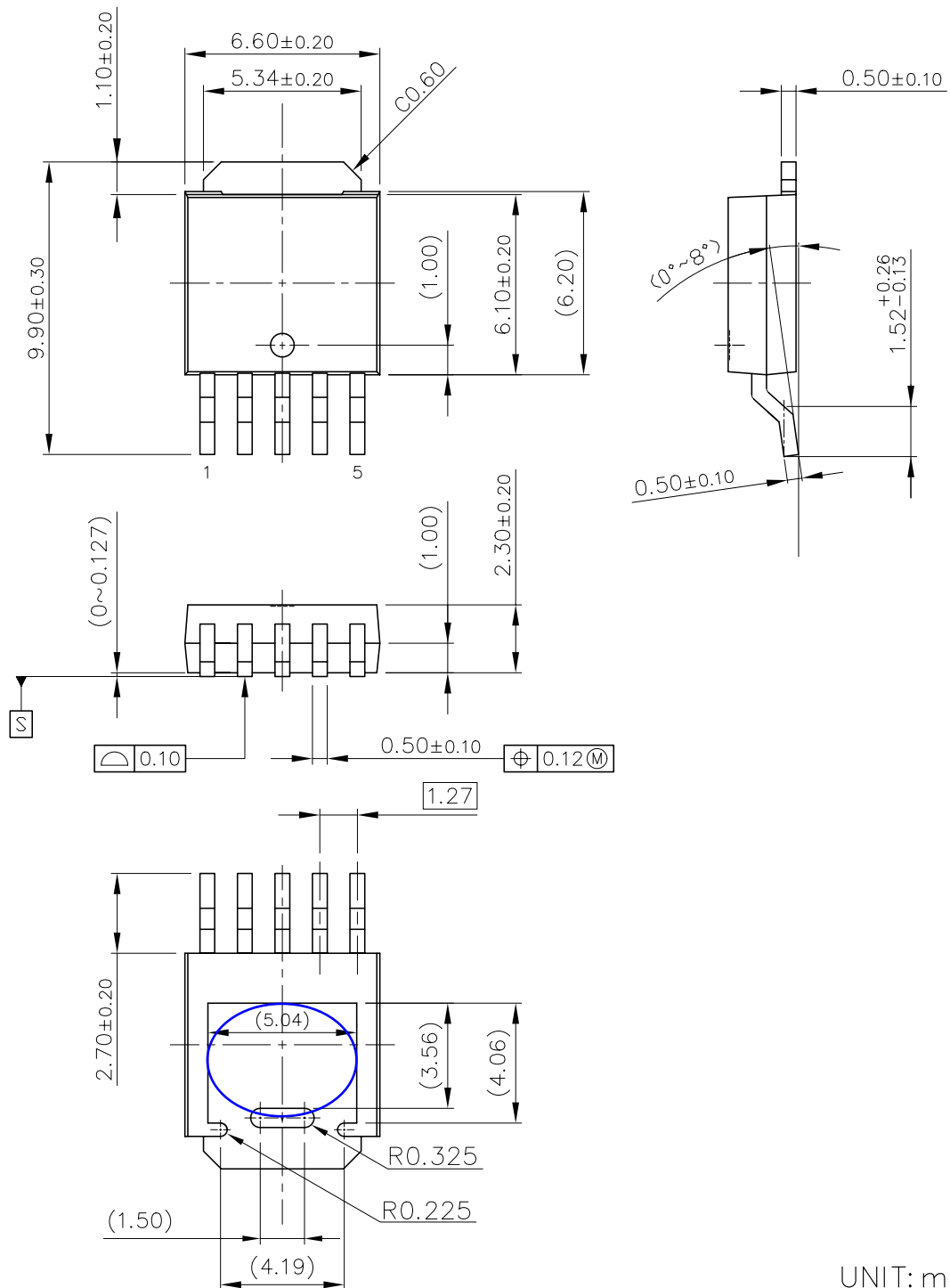

UNIT: mm

TO-252-5-P2 Package Dimensions

* The tab on the bottom of the package shown by blue circle is a substrate potential (GND). It is recommended that this tab be connected to the ground plane on the board but it is possible to leave the tab floating.



1. The products and the product specifications described in this document are subject to change or discontinuation of production without notice for reasons such as improvement. Therefore, before deciding to use the products, please refer to Ricoh sales representatives for the latest information thereon.
2. The materials in this document may not be copied or otherwise reproduced in whole or in part without prior written consent of Ricoh.
3. Please be sure to take any necessary formalities under relevant laws or regulations before exporting or otherwise taking out of your country the products or the technical information described herein.
4. The technical information described in this document shows typical characteristics of and example application circuits for the products. The release of such information is not to be construed as a warranty of or a grant of license under Ricoh's or any third party's intellectual property rights or any other rights.
5. The products listed in this document are intended and designed for use as general electronic components in standard applications (office equipment, telecommunication equipment, measuring instruments, consumer electronic products, amusement equipment etc.). Those customers intending to use a product in an application requiring extreme quality and reliability, for example, in a highly specific application where the failure or misoperation of the product could result in human injury or death (aircraft, spacevehicle, nuclear reactor control system, traffic control system, automotive and transportation equipment, combustion equipment, safety devices, life support system etc.) should first contact us.
6. We are making our continuous effort to improve the quality and reliability of our products, but semiconductor products are likely to fail with certain probability. In order to prevent any injury to persons or damages to property resulting from such failure, customers should be careful enough to incorporate safety measures in their design, such as redundancy feature, fire containment feature and fail-safe feature. We do not assume any liability or responsibility for any loss or damage arising from misuse or inappropriate use of the products.
7. Anti-radiation design is not implemented in the products described in this document.
8. The X-ray exposure can influence functions and characteristics of the products. Confirm the product functions and characteristics in the evaluation stage.
9. WLCSP products should be used in light shielded environments. The light exposure can influence functions and characteristics of the products under operation or storage.
10. There can be variation in the marking when different AOI (Automated Optical Inspection) equipment is used. In the case of recognizing the marking characteristic with AOI, please contact Ricoh sales or our distributor before attempting to use AOI.
11. Please contact Ricoh sales representatives should you have any questions or comments concerning the products or the technical information.



Ricoh is committed to reducing the environmental loading materials in electrical devices with a view to contributing to the protection of human health and the environment.

Ricoh has been providing RoHS compliant products since April 1, 2006 and Halogen-free products since April 1, 2012.

RICOH RICOH ELECTRONIC DEVICES CO., LTD.

<https://www.e-devices.ricoh.co.jp/en/>

Sales & Support Offices

Ricoh Electronic Devices Co., Ltd.

Shin-Yokohama Office (International Sales)

2-3, Shin-Yokohama 3-chome, Kohoku-ku, Yokohama-shi, Kanagawa, 222-8530, Japan
Phone: +81-50-3814-7687 Fax: +81-45-474-0074

Ricoh Americas Holdings, Inc.

675 Campbell Technology Parkway, Suite 200 Campbell, CA 95008, U.S.A.
Phone: +1-408-610-3105

Ricoh Europe (Netherlands) B.V.

Semiconductor Support Centre

Prof. W.H. Keesomlaan 1, 1183 DJ Amstelveen, The Netherlands
Phone: +31-20-5474-309

Ricoh International B.V. - German Branch

Semiconductor Sales and Support Centre

Oberrather Strasse 6, 40472 Düsseldorf, Germany
Phone: +49-211-6546-0

Ricoh Electronic Devices Korea Co., Ltd.

3F, Haesung Bldg, 504, Teheran-ro, Gangnam-gu, Seoul, 135-725, Korea
Phone: +82-2-2135-5700 Fax: +82-2-2051-5713

Ricoh Electronic Devices Shanghai Co., Ltd.

Room 403, No.2 Building, No.690 Bibo Road, Pu Dong New District, Shanghai 201203,
People's Republic of China
Phone: +86-21-5027-3200 Fax: +86-21-5027-3299

Ricoh Electronic Devices Shanghai Co., Ltd.

Shenzhen Branch

1205, Block D (Jinlong Building), Kingkey 100, Hongbao Road, Luohu District,
Shenzhen, China
Phone: +86-755-8348-7600 Ext 225

Ricoh Electronic Devices Co., Ltd.

Taipei office

Room 109, 10F-1, No.51, Hengyang Rd., Taipei City, Taiwan
Phone: +886-2-2313-1621/1622 Fax: +886-2-2313-1623

Mouser Electronics

Authorized Distributor

Click to View Pricing, Inventory, Delivery & Lifecycle Information:

[Ricoch Electronics:](#)

[R1560J501B-T1-YE](#) [R1560J331B-T1-YE](#)

Компания «Океан Электроники» предлагает заключение долгосрочных отношений при поставках импортных электронных компонентов на взаимовыгодных условиях!

Наши преимущества:

- Поставка оригинальных импортных электронных компонентов напрямую с производств Америки, Европы и Азии, а так же с крупнейших складов мира;
- Широкая линейка поставок активных и пассивных импортных электронных компонентов (более 30 млн. наименований);
- Поставка сложных, дефицитных, либо снятых с производства позиций;
- Оперативные сроки поставки под заказ (от 5 рабочих дней);
- Экспресс доставка в любую точку России;
- Помощь Конструкторского Отдела и консультации квалифицированных инженеров;
- Техническая поддержка проекта, помощь в подборе аналогов, поставка прототипов;
- Поставка электронных компонентов под контролем ВП;
- Система менеджмента качества сертифицирована по Международному стандарту ISO 9001;
- При необходимости вся продукция военного и аэрокосмического назначения проходит испытания и сертификацию в лаборатории (по согласованию с заказчиком);
- Поставка специализированных компонентов военного и аэрокосмического уровня качества (Xilinx, Altera, Analog Devices, Intersil, Interpoint, Microsemi, Actel, Aeroflex, Peregrine, VPT, Syfer, Eurofarad, Texas Instruments, MS Kennedy, Miteq, Cobham, E2V, MA-COM, Hittite, Mini-Circuits, General Dynamics и др.);

Компания «Океан Электроники» является официальным дистрибьютором и эксклюзивным представителем в России одного из крупнейших производителей разъемов военного и аэрокосмического назначения «JONHON», а так же официальным дистрибьютором и эксклюзивным представителем в России производителя высокотехнологичных и надежных решений для передачи СВЧ сигналов «FORSTAR».



JONHON

«JONHON» (основан в 1970 г.)

Разъемы специального, военного и аэрокосмического назначения:

(Применяются в военной, авиационной, аэрокосмической, морской, железнодорожной, горно- и нефтедобывающей отраслях промышленности)

«FORSTAR» (основан в 1998 г.)

ВЧ соединители, коаксиальные кабели, кабельные сборки и микроволновые компоненты:

(Применяются в телекоммуникациях гражданского и специального назначения, в средствах связи, РЛС, а так же военной, авиационной и аэрокосмической отраслях промышленности).



Телефон: 8 (812) 309-75-97 (многоканальный)

Факс: 8 (812) 320-03-32

Электронная почта: ocean@oceanchips.ru

Web: <http://oceanchips.ru/>

Адрес: 198099, г. Санкт-Петербург, ул. Калинина, д. 2, корп. 4, лит. А