

HS4040xAQx Series

AUTOMOTIVE GRADE

RoHS

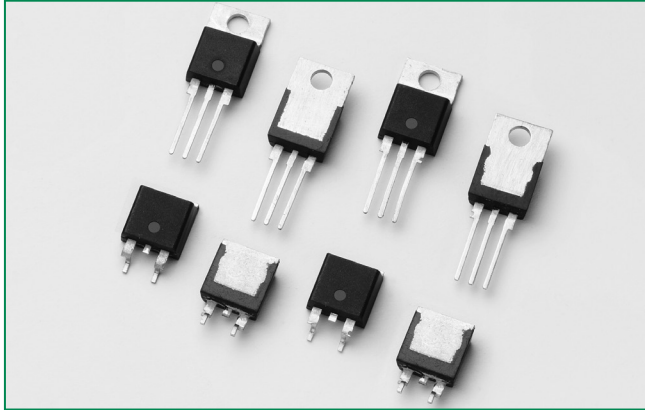

Description

The HS4040xAQx series of SCRs offer fast turn-off time (tq) characteristics required for applications such as power inverters, switching regulator, and high frequency pulse circuits.

These fast turn-off time SCRs offer high dv/dt and high di/dt characteristics required in higher frequency (>1000 PPS) switching circuits and a higher temperature environment.

Features & Benefits

- RoHS compliant
- Voltage capability up to 400 V
- Surge capability up to 520 A
- TO-220 and TO-263 packages
- AEC-Q101 Fully compliant
- 150°C maximum junction temperature

Applications

Fast turn-off time SCRs are ideal for multi phase voltage regulator circuits, DC/AC inverters, and higher frequency pulsing power supplies.

Main Features

Symbol	Value	Unit
$I_{T(RMS)}$	40	A
V_{DRM}/V_{RRM}	400	V
I_{GT}	15 to 65	mA

Schematic Symbol

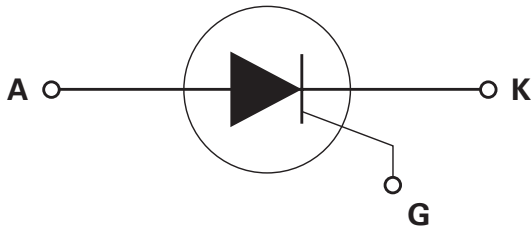

Absolute Maximum Ratings

Symbol	Parameter	Test Conditions	Value	Unit
$I_{T(RMS)}$	RMS on-state current	$T_c = 115^\circ\text{C}$	40	A
$I_{T(AV)}$	Average on-state current	$T_c = 115^\circ\text{C}$	25.0	A
I_{TSM}	Peak non-repetitive surge current	single half cycle; f = 50Hz; T_j (initial) = 25°C	430	A
		single half cycle; f = 60Hz; T_j (initial) = 25°C	520	
I^2t	I^2t Value for fusing	$t_p = 8.3$ ms	1122	A ² s
di/dt	Critical rate of rise of on-state current	f = 60Hz; $T_j = 150^\circ\text{C}$	175	A/ μ s
I_{GM}	Peak gate current	$T_j = 150^\circ\text{C}$	3.5	A
$P_{G(AV)}$	Average gate power dissipation	$T_j = 150^\circ\text{C}$	0.8	W
T_{stg}	Storage temperature range		-40 to 150	°C
T_j	Operating junction temperature range		-40 to 150	°C
V_{DSM}/V_{RSM}	Peak non-repetitive blocking voltage	Pw=100 μ s	500	V

Electrical Characteristics (T_J = 25°C, unless otherwise specified)

Symbol	Test Conditions		HS4040xAQ	HS4040xAQ2	HS4040xAQ3	Unit
I _{GT}	V _D = 12V; R _L = 30 Ω	MAX.	35	45	65	mA
		MIN.	15	30	38	
V _{GT}		MAX.	1.5			V
I _{GT}	V _D = 12V; R _L = 30Ω; T _J = -40°C	MAX.	75	95	160	mA
dv/dt	V _D = V _{DRM'} ; gate open; T _J = 150°C	MIN.	550			V/μs
V _{GD}	V _D = V _{DRM'} ; R _L = 3.3 kΩ; T _J = 150°C	MIN.	0.2			V
I _H	I _T = 400mA (initial)	MAX.	70	120	200	mA
t _q	I _T =0.5A; t _p =50μs; dv/dt=5V/μs; di/dt=-30A/μs	MAX.	15	12	5	μs
t _{gt}	I _G = 2 x I _{GT} ; PW = 15μs; I _T = 80A	TYP.	3.0			μs

Static Characteristics

Symbol	Test Conditions		HS4040xAQ	HS4040xAQ2	HS4040xAQ3	Unit
V _{TM}	I _T = 80A; t _p = 380μs	MAX.	1.6		1.8	V
I _{DRM} / I _{RRM}	V _{DRM} / V _{RRM}	T _J = 25°C	10			μA
		T _J = 125°C	2000			
		T _J = 150°C	4000			

Thermal Resistances

Symbol	Parameter	Value	Unit
R _{θ(J-C)}	Junction to case (AC)	0.6	°C/W

Figure 1: Normalized DC Holding Current vs. Junction Temperature

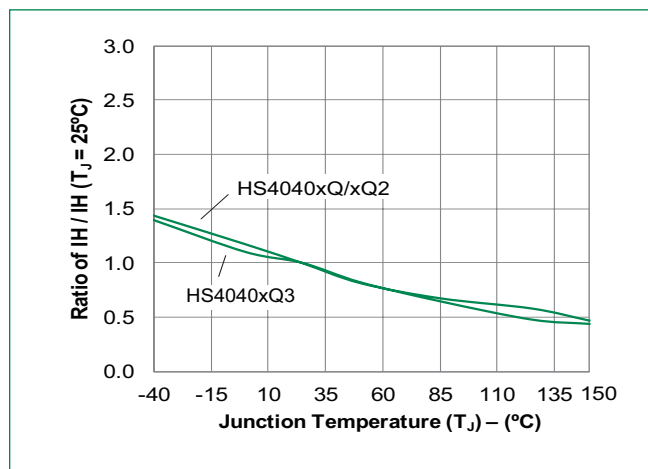

Figure 2: Normalized DC Gate Trigger Current vs. Junction Temperature

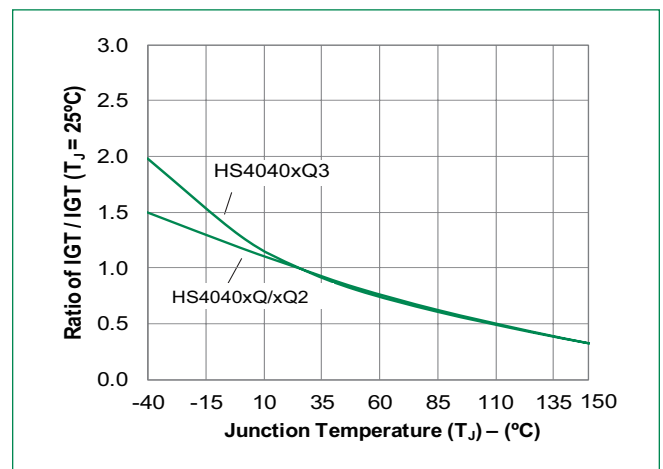

Figure 3: Normalized DC Gate Trigger Voltage vs. Junction Temperature

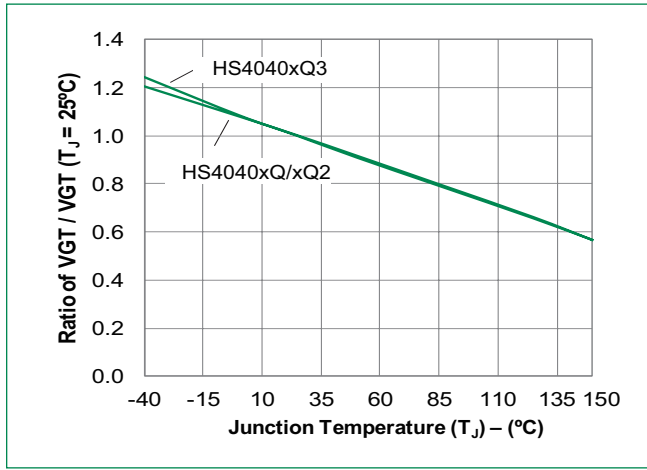

Figure 4: On-State Current vs. On-State Voltage (Typical)

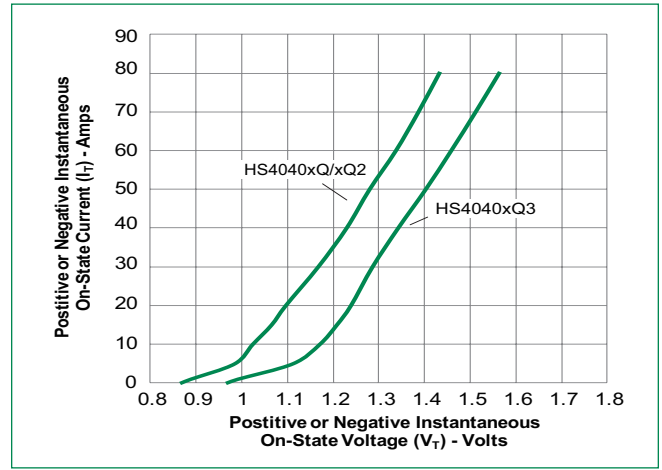

Figure 5: Power Dissipation (Typical) vs. RMS On-State Current

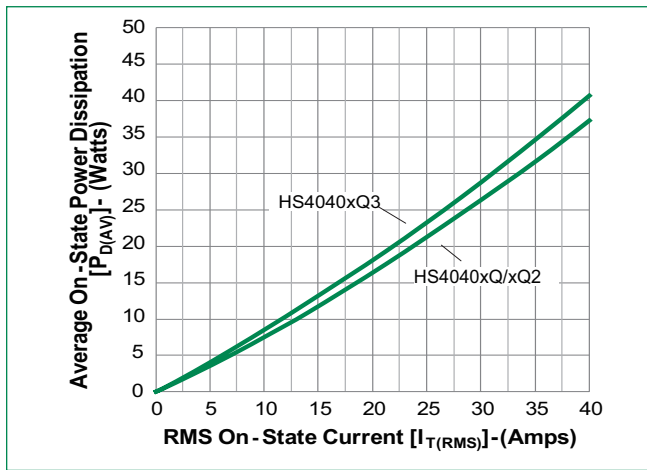

Figure 6: Maximum Allowable Case Temperature vs. RMS On-State Current

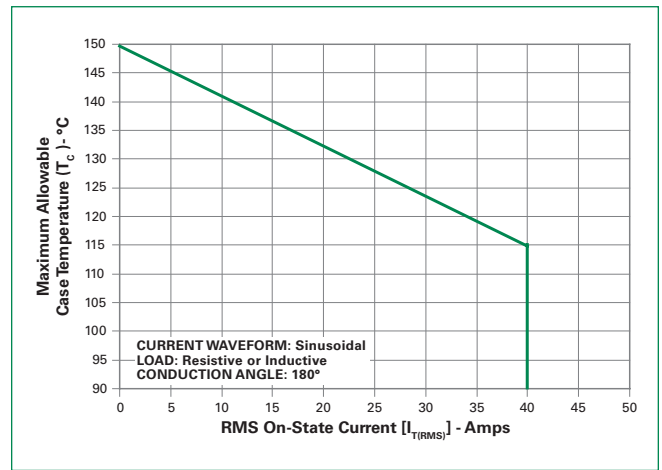

Figure 7: Maximum Allowable Case Temperature vs. Average On-State Current

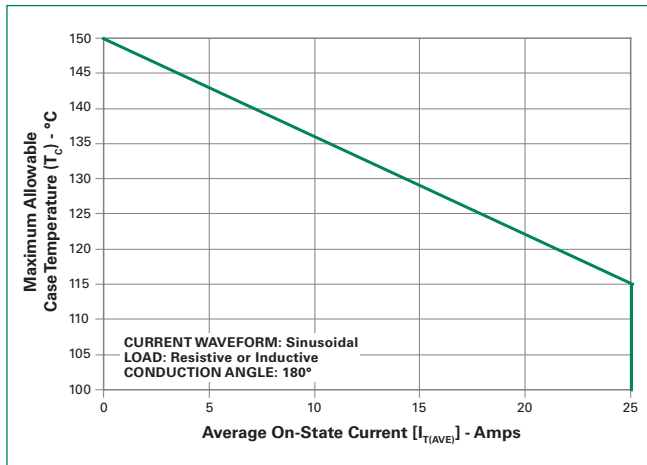

Figure 8: Peak Capacitor Discharge Current

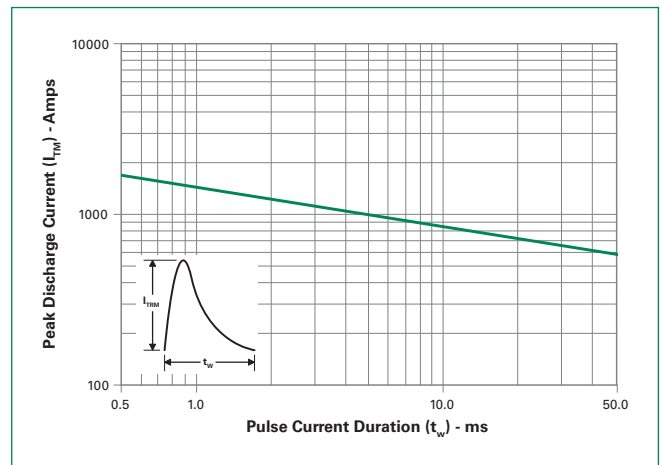

Figure 9: Peak Capacitor Discharge Current Derating

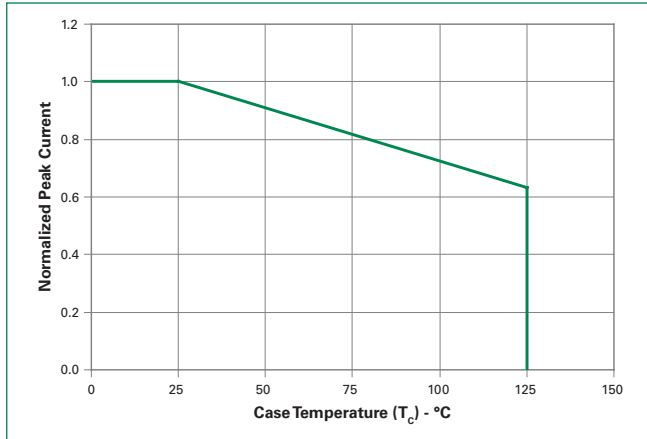
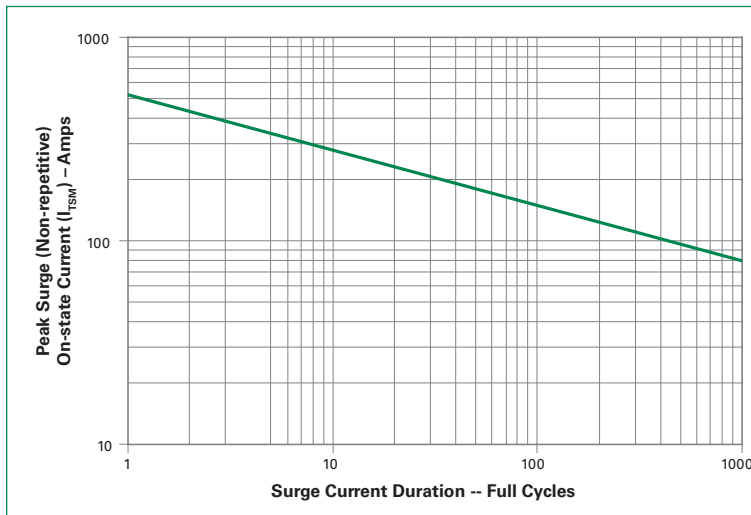

Figure 10: Surge Peak On-State Current vs. Number of Cycles



SUPPLY FREQUENCY: 60 Hz Sinusoidal
LOAD: Resistive
RMS On-State Current: [I_{T(RMS)}]: Maximum Rated Value at Specified Case Temperature

Notes:
1. Gate control may be lost during and immediately following surge current interval.
2. Overload may not be repeated until junction temperature has returned to steady-state rated value.

Soldering Parameters

Reflow Condition	Pb – Free assembly	
Pre Heat	- Temperature Min (T _{s(min)})	150°C
	- Temperature Max (T _{s(max)})	200°C
	- Time (min to max) (t _s)	60 – 180 secs
Average ramp up rate (Liquidus Temp (T _L) to peak)		5°C/second max
T _{s(max)} to T _L - Ramp-up Rate		5°C/second max
Reflow	- Temperature (T _L) (Liquidus)	217°C
	- Temperature (t _L)	60 – 150 seconds
Peak Temperature (T _p)		260 ^{+0/-5} °C
Time within 5°C of actual peak Temperature (t _p)		20 – 40 seconds
Ramp-down Rate		5°C/second max
Time 25°C to peak Temperature (T _p)		8 minutes Max.
Do not exceed		280°C

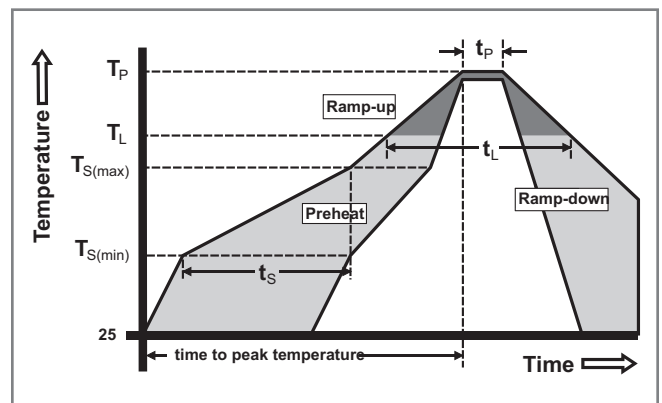

Physical Specifications

Terminal Finish	100% Matte Tin-plated
Body Material	UL recognized epoxy meeting flammability classification V-0
Lead Material	Copper Alloy

Design Considerations

Careful selection of the correct device for the application's operating parameters and environment will go a long way toward extending the operating life of the Thyristor. Good design practice should limit the maximum continuous current through the main terminals to 75% of the device rating. Other ways to ensure long life for a power discrete semiconductor are proper heat sinking and selection of voltage ratings for worst case conditions. Overheating, overvoltage (including dv/dt), and surge currents are the main killers of semiconductors. Correct mounting, soldering, and forming of the leads also help protect against component damage.

Environmental Specifications

Test	Specifications and Conditions
AC Blocking	MIL-STD-750, M-1040, Cond A Applied Peak AC voltage @ 150°C for 1008 hours
Biased Temperature & Humidity	EIA / JEDEC, JESD22-A101 1008 hours; 320V - DC: 85°C; 85% rel humidity
Temperature Cycling	JESD22 A-104 Appendix 6 -55°C to 150°C, 15-minute dwell, 1000 cycles
Intermittent Operational Life	T _A =25C, ΔT _J ≥ 100°C, 1008hrs
Autoclave (Pressure Cooker Test)	EIA/JEDEC: JESD22-A102 121°C, 100%RH, 15psig, 96hours
Resistance to Solder Heat	JESD22 A-111: 260°C, 10 seconds
Solderability	ANSI/J-STD-002, category 3, Test A

Dimensions — TO-220AB (R-Package) — Non-Isolated Mounting Tab Common with Center Lead

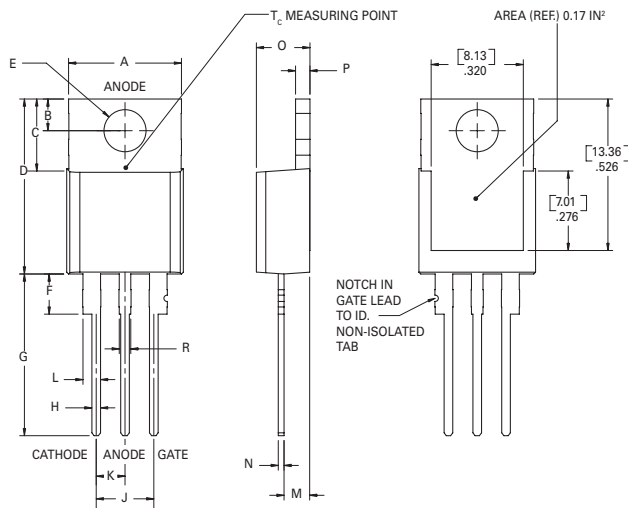

Note: Maximum torque to be applied to mounting tab is 8 in.-lbs. (0.904 Nm).

Dimension	Inches		Millimeters	
	Min	Max	Min	Max
A	0.380	0.420	9.65	10.67
B	0.105	0.115	2.67	2.92
C	0.230	0.250	5.84	6.35
D	0.590	0.620	14.99	15.75
E	0.142	0.147	3.61	3.73
F	0.110	0.130	2.79	3.30
G	0.540	0.575	13.72	14.61
H	0.025	0.035	0.64	0.89
J	0.195	0.205	4.95	5.21
K	0.095	0.105	2.41	2.67
L	0.060	0.075	1.52	1.91
M	0.085	0.095	2.16	2.41
N	0.018	0.024	0.46	0.61
O	0.178	0.188	4.52	4.78
P	0.045	0.060	1.14	1.52
R	0.038	0.048	0.97	1.22

Dimensions – TO- 263 (N-package) – D²-Pak Surface Mount

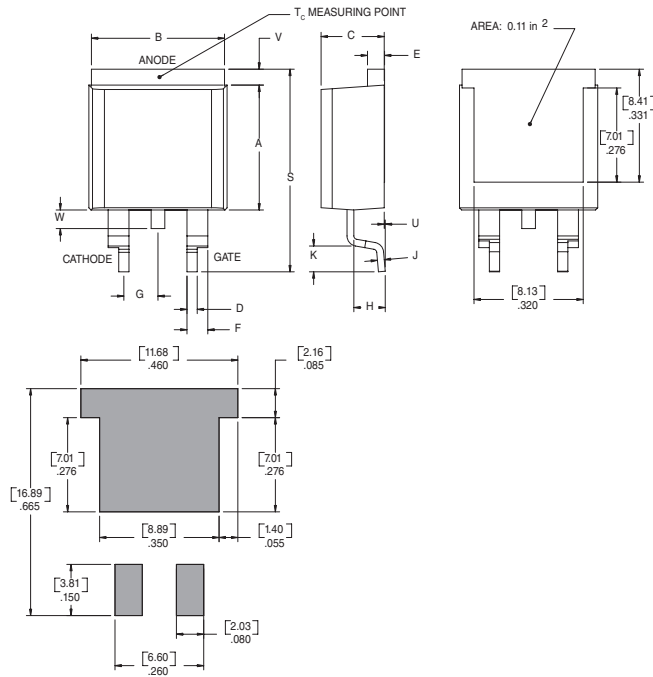

Dimension	Inches		Millimeters	
	Min	Max	Min	Max
A	0.360	0.370	9.14	9.40
B	0.380	0.420	9.65	10.67
C	0.178	0.188	4.52	4.78
D	0.025	0.035	0.63	0.89
E	0.048	0.055	1.22	1.40
F	0.060	0.075	1.52	1.91
G	0.095	0.105	2.41	2.67
H	0.083	0.093	2.11	2.36
J	0.018	0.024	0.46	0.61
K	0.090	0.110	2.29	2.79
S	0.590	0.625	14.99	15.87
V	0.035	0.045	0.89	1.14
U	0.002	0.010	0.05	0.25
W	0.040	0.070	1.02	1.78

Part Numbering System

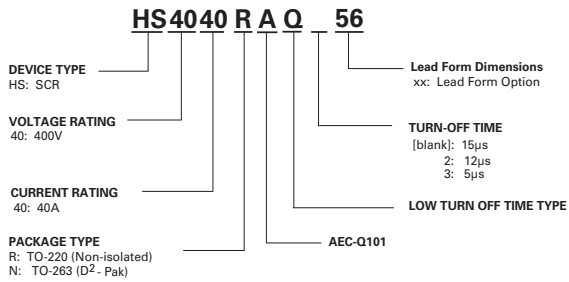

Part Marking System

TO-220 AB - (R Package)
TO-263 (N Package)

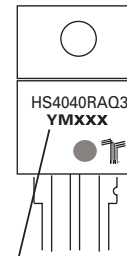

Date Code Marking
Y: Year Code
M: Month Code
XXX: Lot Trace Code

Product Selector

Part Number	Voltage	Gate Sensitivity	Type	Package
	400V			
HS4040RAQ	X	15-35	Standard SCR	TO-220AB
HS4040NAQ	X	15-35	Standard SCR	TO-263
HS4040RAQ2	X	30-45	Standard SCR	TO-220AB
HS4040NAQ2	X	30-45	Standard SCR	TO-263
HS4040RAQ3	X	38-65	Standard SCR	TO-220AB
HS4040NAQ3	X	38-65	Standard SCR	TO-263

Packing Options

Part Number	Marking	Weight	Packing Mode	Base Quantity
HS4040RAQTP	HS4040RAQ	2.2g	Tube	500 (50 per tube)
HS4040RAQ2TP	HS4040RAQ2	2.2g	Tube	500 (50 per tube)
HS4040RAQ3TP	HS4040RAQ3	2.2g	Tube	500 (50 per tube)
HS4040NAQRP	HS4040NAQ	1.6g	Embossed Carrier	500
HS4040NAQ2RP	HS4040NAQ2	1.6g	Embossed Carrier	500
HS4040NAQ3RP	HS4040NAQ3	1.6g	Embossed Carrier	500

Reel Pack (RP) for TO-263 Embossed Carrier Specifications

Meets all EIA-481-2 Standards

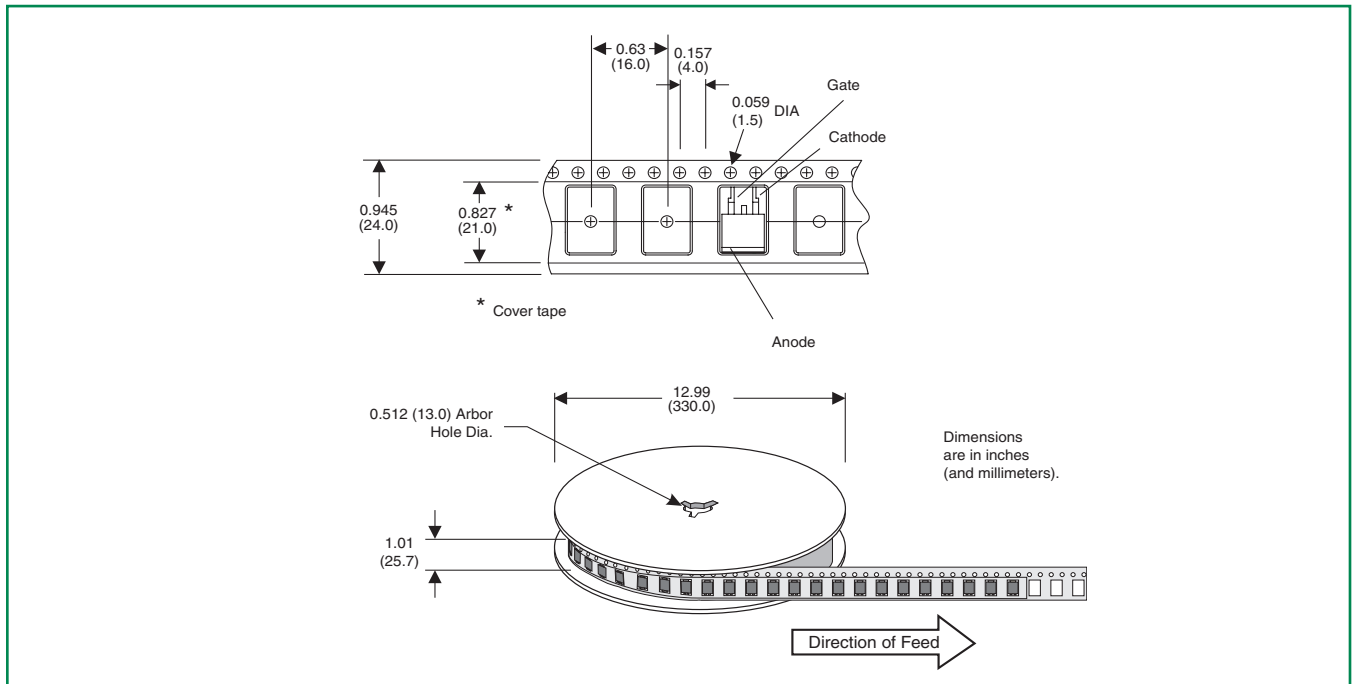

Компания «Океан Электроники» предлагает заключение долгосрочных отношений при поставках импортных электронных компонентов на взаимовыгодных условиях!

Наши преимущества:

- Поставка оригинальных импортных электронных компонентов напрямую с производств Америки, Европы и Азии, а так же с крупнейших складов мира;
- Широкая линейка поставок активных и пассивных импортных электронных компонентов (более 30 млн. наименований);
- Поставка сложных, дефицитных, либо снятых с производства позиций;
- Оперативные сроки поставки под заказ (от 5 рабочих дней);
- Экспресс доставка в любую точку России;
- Помощь Конструкторского Отдела и консультации квалифицированных инженеров;
- Техническая поддержка проекта, помощь в подборе аналогов, поставка прототипов;
- Поставка электронных компонентов под контролем ВП;
- Система менеджмента качества сертифицирована по Международному стандарту ISO 9001;
- При необходимости вся продукция военного и аэрокосмического назначения проходит испытания и сертификацию в лаборатории (по согласованию с заказчиком);
- Поставка специализированных компонентов военного и аэрокосмического уровня качества (Xilinx, Altera, Analog Devices, Intersil, Interpoint, Microsemi, Actel, Aeroflex, Peregrine, VPT, Syfer, Eurofarad, Texas Instruments, MS Kennedy, Miteq, Cobham, E2V, MA-COM, Hittite, Mini-Circuits, General Dynamics и др.);

Компания «Океан Электроники» является официальным дистрибьютором и эксклюзивным представителем в России одного из крупнейших производителей разъемов военного и аэрокосмического назначения «**JONHON**», а так же официальным дистрибьютором и эксклюзивным представителем в России производителя высокотехнологичных и надежных решений для передачи СВЧ сигналов «**FORSTAR**».



JONHON

«**JONHON**» (основан в 1970 г.)

Разъемы специального, военного и аэрокосмического назначения:

(Применяются в военной, авиационной, аэрокосмической, морской, железнодорожной, горно- и нефтедобывающей отраслях промышленности)

«**FORSTAR**» (основан в 1998 г.)

ВЧ соединители, коаксиальные кабели,
кабельные сборки и микроволновые компоненты:

(Применяются в телекоммуникациях гражданского и специального назначения, в средствах связи, РЛС, а так же военной, авиационной и аэрокосмической отраслях промышленности).



Телефон: 8 (812) 309-75-97 (многоканальный)

Факс: 8 (812) 320-03-32

Электронная почта: ocean@oceanchips.ru

Web: <http://oceanchips.ru/>

Адрес: 198099, г. Санкт-Петербург, ул. Калинина, д. 2, корп. 4, лит. А