



# TAOGLAS®



## Datasheet

### Meteor

**Part No:**  
FW.86.RNT.M

### Description:

Meteor-868MHz Flexible Whip Monopole Antenna RP-N Type(M) Straight

### Features:

External 868MHz Monopole Antenna

Omni-directional

Designed for Outdoor Use

Over 90% efficiency\*

Over 4dBi high peak gain\*

Robust Inner Steel Core

Antenna height 246mm

RP-N Type(M) Straight Connector

IP65 dust and water-resistant

\*Tested on 30cm\*30cm Ground Plane

RoHS Compliant

1.	Introduction	3
2.	Specifications	4
3.	Antenna Characteristics	5
4.	Radiation Patterns	8
5.	Mechanical Drawing	11
6.	Packaging	12
<hr/>		
	Changelog	13

Taoglas makes no warranties based on the accuracy or completeness of the contents of this document and reserves the right to make changes to specifications and product descriptions at any time without notice. Taoglas reserves all rights to this document and the information contained herein. Reproduction, use or disclosure to third parties without express permission is strictly prohibited.



## 1. Introduction



The FW.86 is a flexible 868MHz whip antenna with an RP-N type (M) connector for outdoor use. It features excellent efficiency (>95%) and high peak gain (>4.5 dBi) at 868MHz on a 30x30 cm ground plane.

The antenna was specifically developed for monitoring systems, such as weather monitoring, motion/vibration sensors, and pollutants monitoring.

The FW.86 has an excellent omni-directional radiation pattern, ensuring wide coverage. The antenna's high efficiency means that it allows your radio to consume less power than with a lower efficiency antenna when transferring data. It also means a better strength of signal, and better sensitivity in areas of low signal levels. The antenna performs at its best while attached to a ground plane with dimensions of at least 30x30 cm. For an environment where there is no ground-plane available we recommend to use the TI.18 or OMB.868.

The FW.86 whip is made of a flexible inner steel core covered by PE so it is extremely resistant to abrasion and maintains its original shape and RF performance even after shock. This rugged design and IP65 rating on the housing ensure high reliability.

This antenna also comes with SMA(M) connector as standard. Other custom variants can be provided subject to NRE and MOQ. Contact your regional Taoglas office for details.

## 2. Specifications

868MHz		
Center Frequency	868MHz	
	In free space	On 30x30cm ground
Efficiency	27.2 %	96.6 %
Peak Gain	-1.57 dBi	4.78 dBi
Return loss	< -3dB	< -15dB
VSWR	≤ 6:1	≤ 2:1
Impedance	50Ω	
Polarization	Linear	
Radiation Pattern	Omni-Directional	
Input Power	2 W	
Tested Power	10 W	
Mechanical		
Dimensions	Height 246 ± 6 mm	
Base Diameter	20 ± 0.5 mm	
Whip Diameter	6.2 ± 0.6 mm	
Casing	ABS	
Connector	RP-N Type(M) Straight	
Weight	48.5 g	
Dust and Water Resistance	IP65 (housing)	
Environmental		
Temperature Range	-40°C to 85°C	
Humidity	Non-condensing 65°C 95% RH	

### 3. Antenna Characteristics

#### 3.1 Return Loss

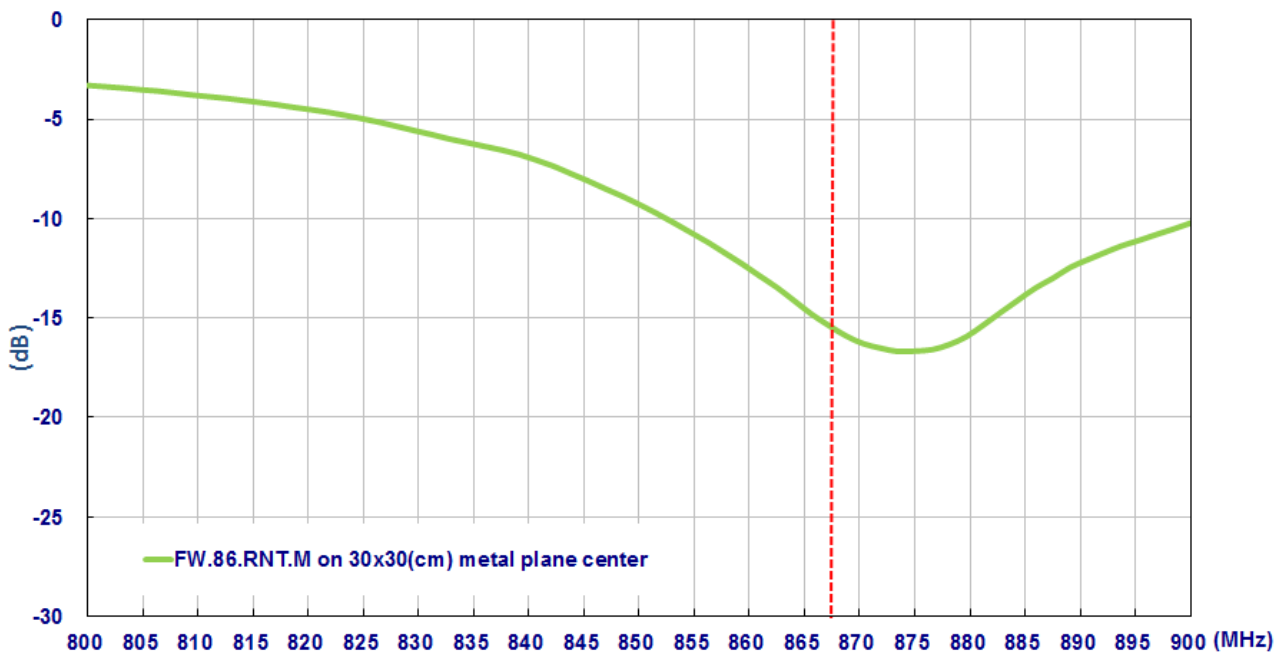
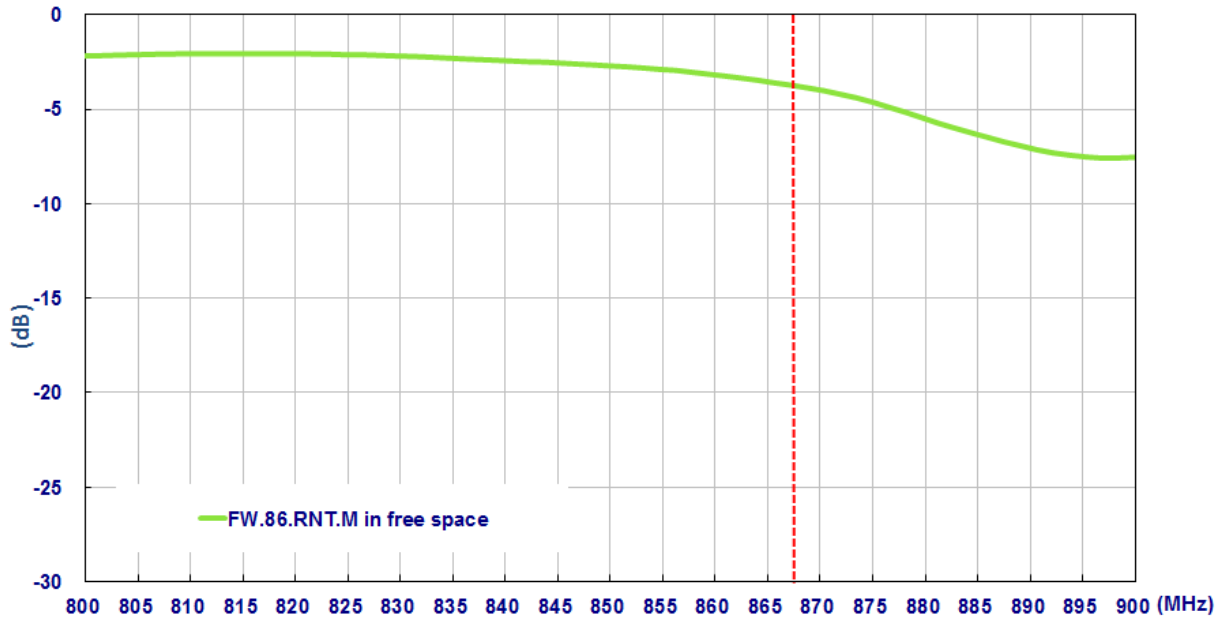

3.2 Efficiency

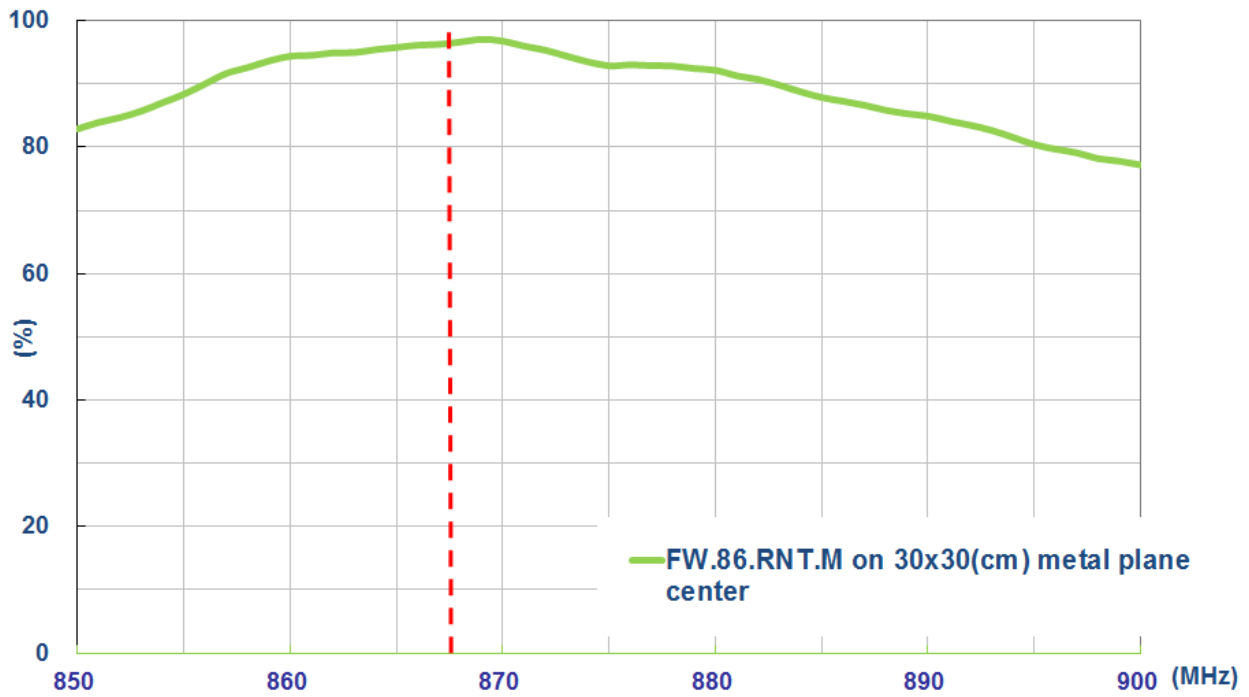
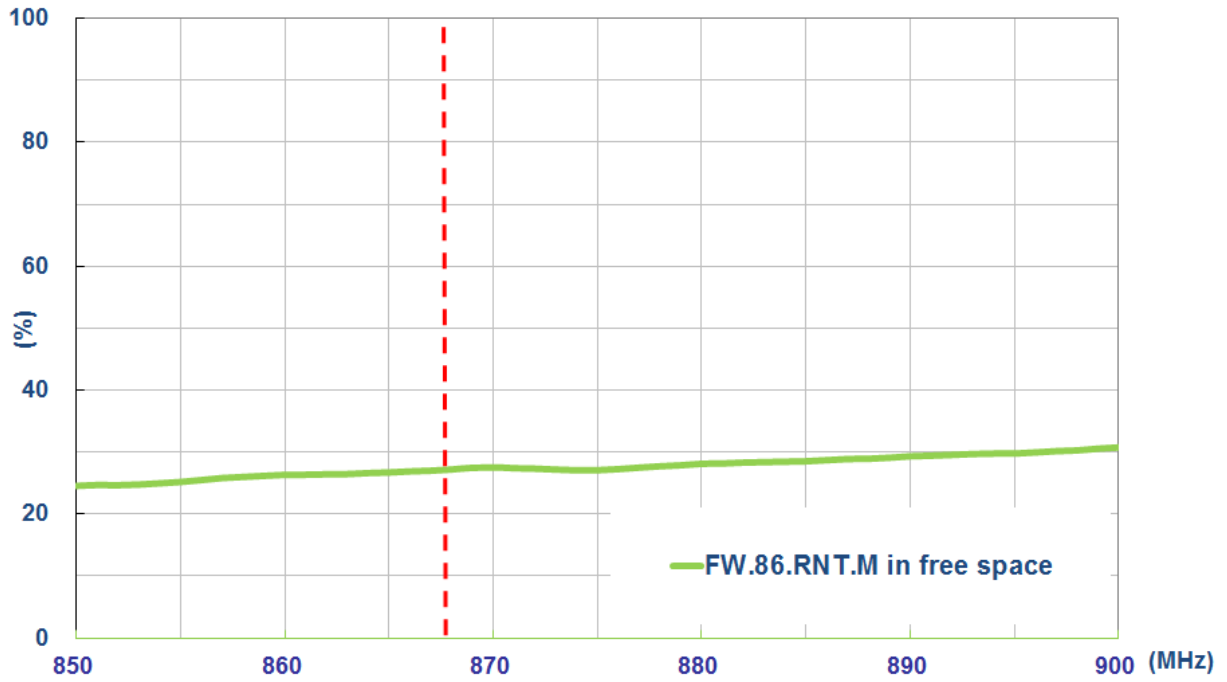

### 3.3 Peak Gain

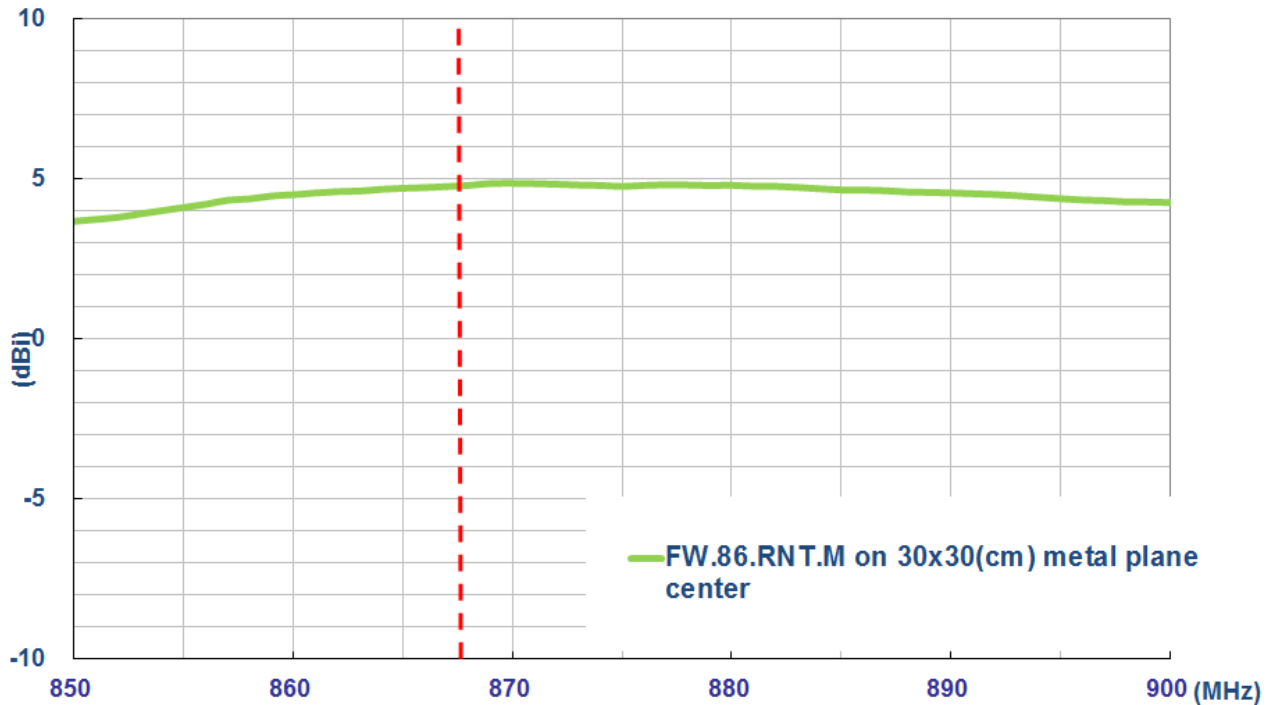
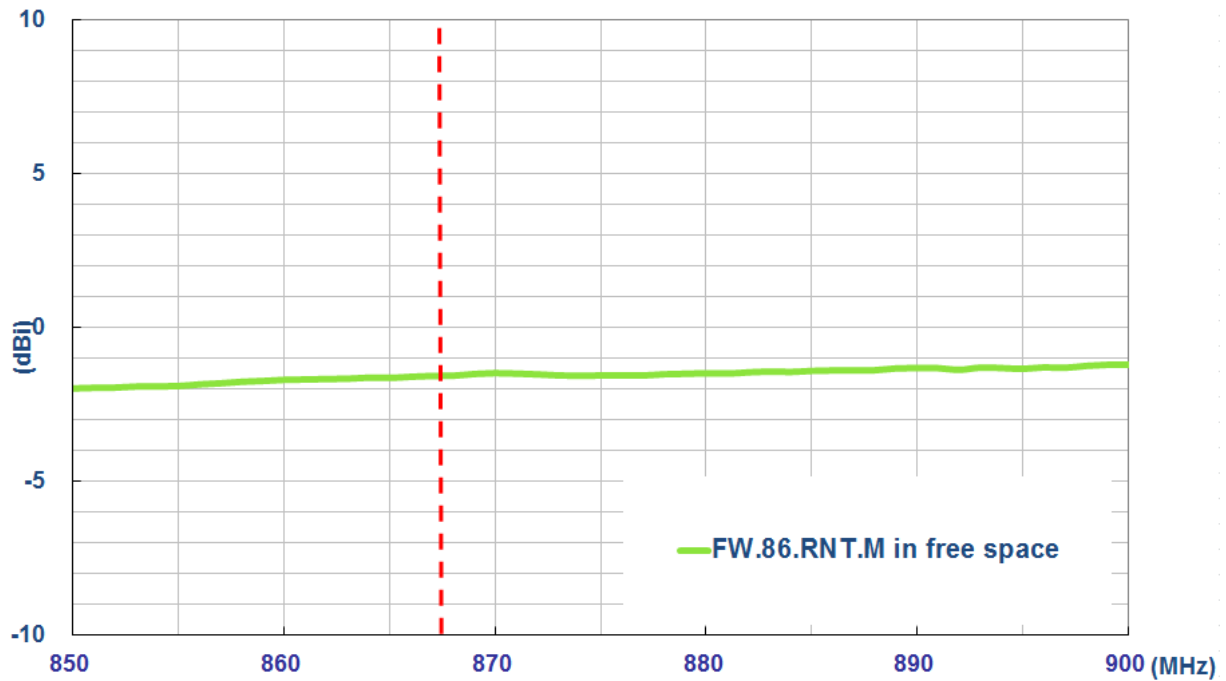

## 4. Radiation Patterns

### 4.1 Test Setup

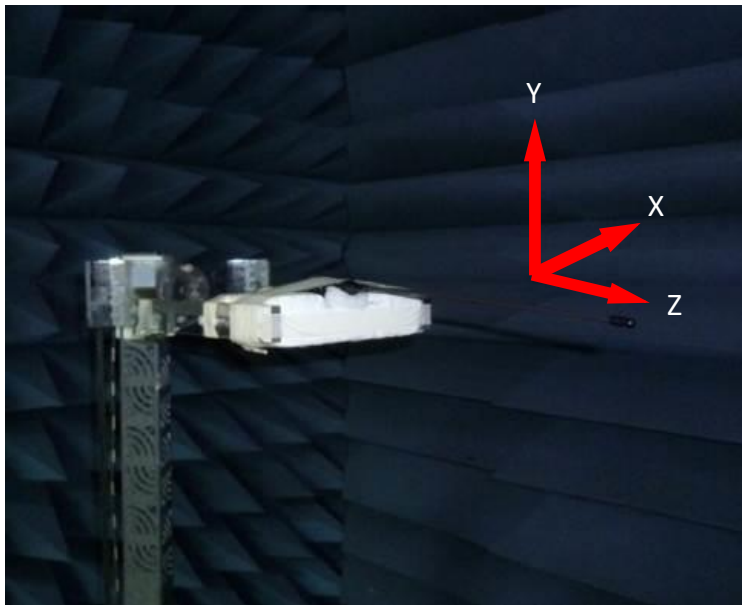

Free Space

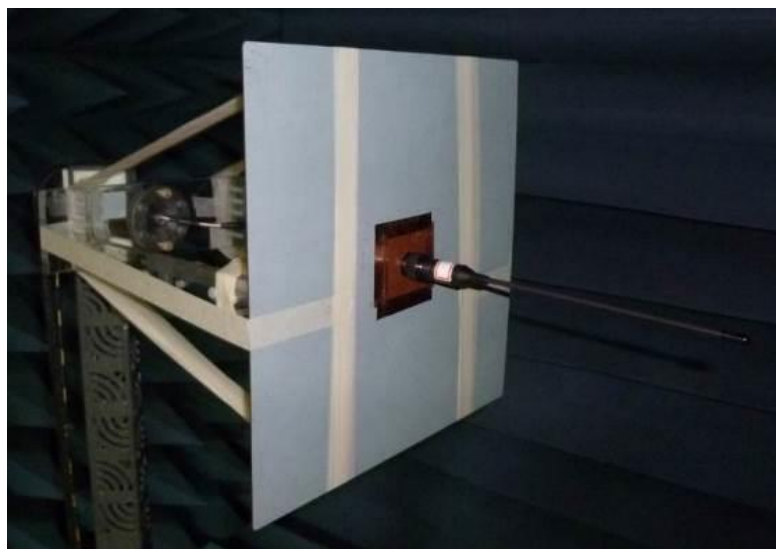

On 30x30 cm ground plane



## 4.2 3D and 2D Radiation Patterns (Free Space)

XY Plane

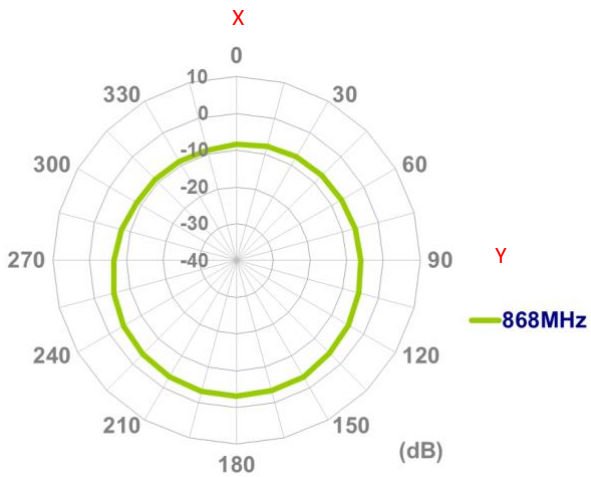

XZ Plane

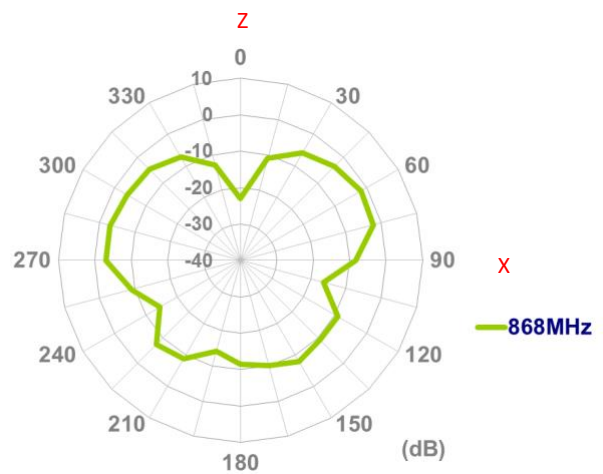

YZ Plane

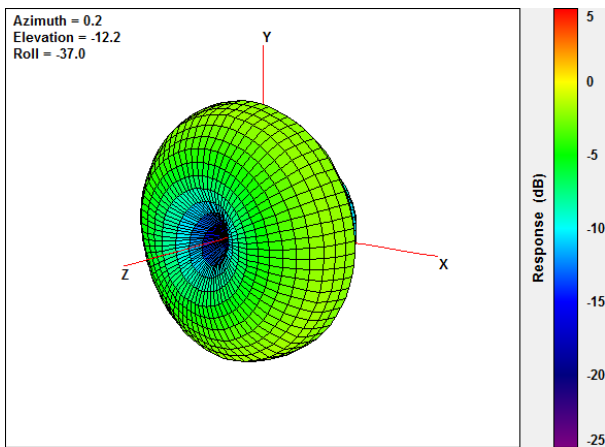
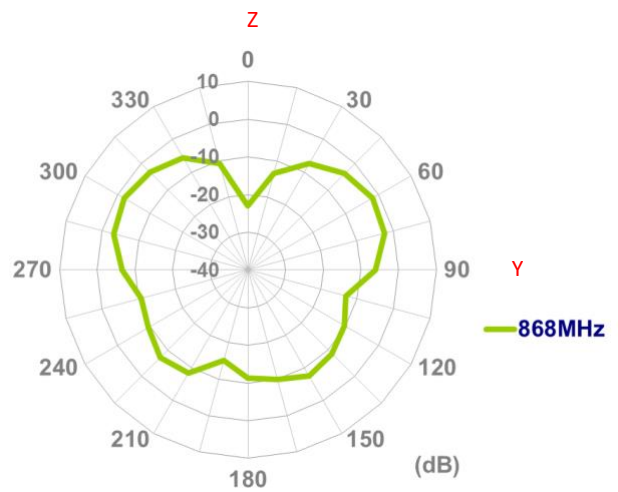

3D Radiation Pattern @ 868MHz

## 4.2 3D and 2D Radiation Patterns (On 30cm\*30cm Ground Plane)

XY Plane

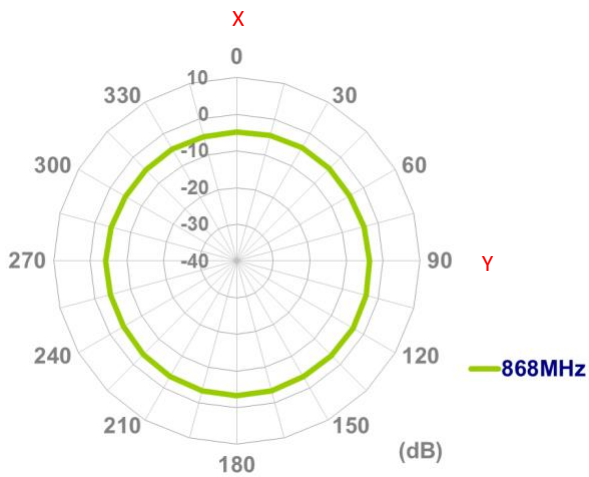

XZ Plane

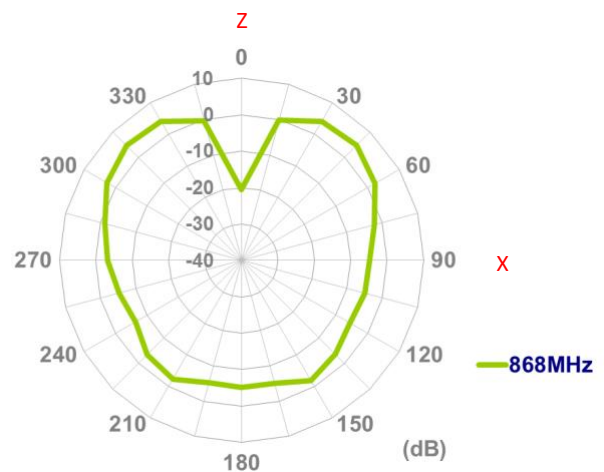

YZ Plane

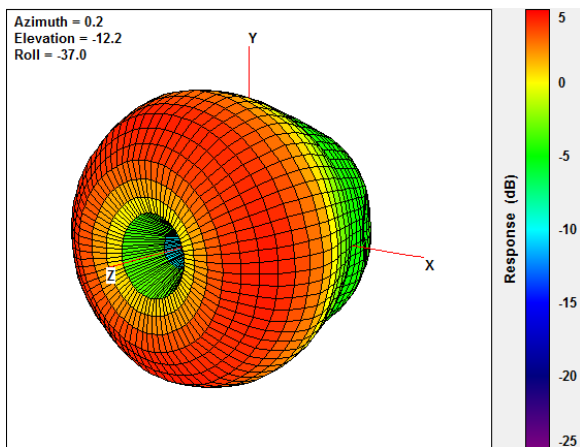
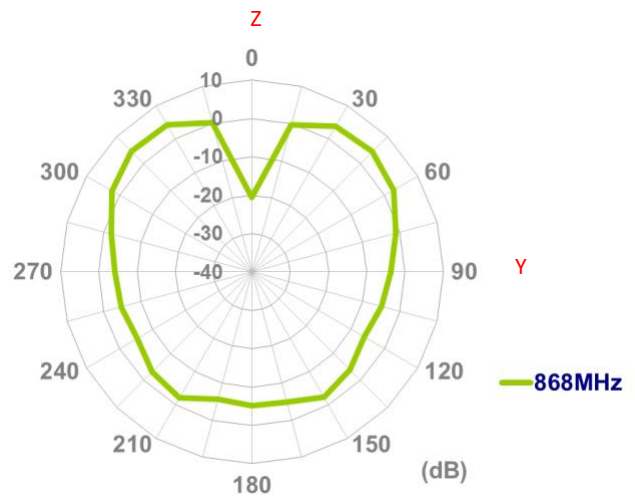

3D Radiation Pattern @ 868MHz

## 5. Mechanical Drawing (Units: mm)

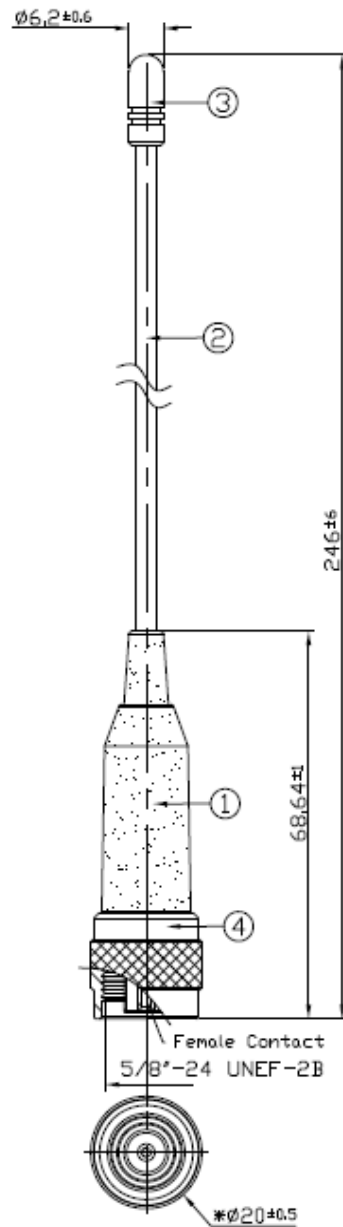

	Name	Material	Finish	QTY
①	Housing	ABS	Black	1
②	Flexible Whip	Steel+PE Jacket	Black	1
③	Cap	ABS	Black	1
④	RP-N-TYPE(M) ST	Brass	Black	1

## 6. Packaging

1pcs FW.86.RNT.M per PE Bag  
 Bag Dimensions - 380\*50mm  
 Weight - 50g

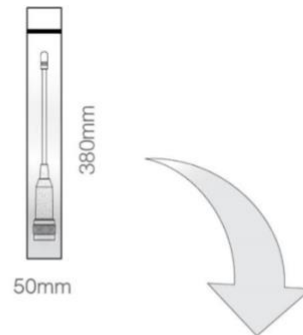

50 PE Bags per Large PE Bag  
 Large PE Bag Dimensions - 470\*340mm  
 Weight - 2Kg

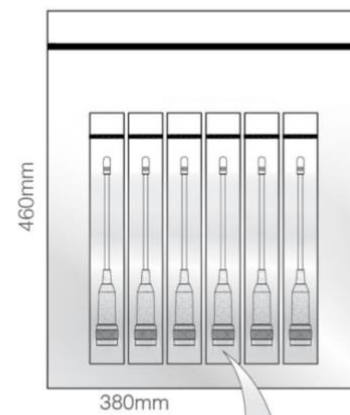

4 Large PE Bags per Carton  
 Carton Dimensions - 400\*300\*250mm  
 Weight - 10.5Kg

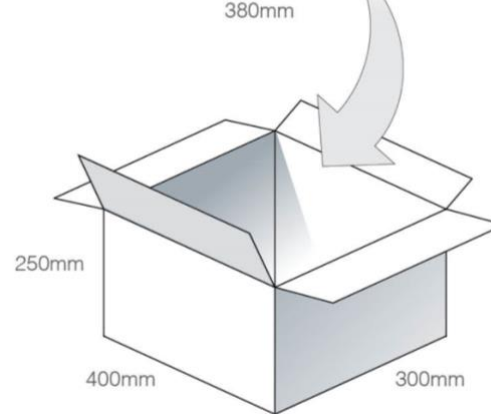

**Pallet Dimensions:**  
 1100\*1200\*1500mm  
 60 Cartons Per Pallet  
 12 Cartons Per Layer  
 5 Layers

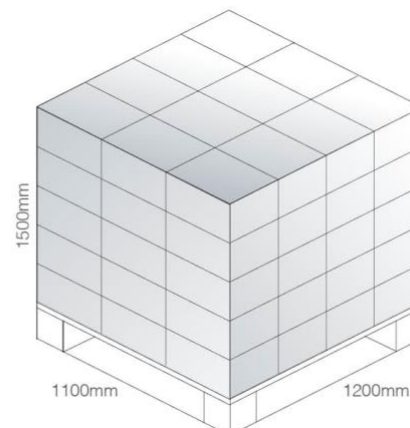

Changelog for the datasheet

**SPE-15-8-035 - FW.86.RNT.M**

<b>Revision: B</b>	
Date:	2019-08-16
Changes:	Updated to new format
Changes Made by:	Dan Cantwell

**Previous Revisions**

<table border="1"> <tr> <td colspan="2"><b>Revision: A (Original First Release)</b></td> </tr> <tr> <td>Date:</td> <td>2015-06-15</td> </tr> <tr> <td>Notes:</td> <td></td> </tr> <tr> <td>Author:</td> <td>Wayne Yang</td> </tr> </table>	<b>Revision: A (Original First Release)</b>		Date:	2015-06-15	Notes:		Author:	Wayne Yang	
<b>Revision: A (Original First Release)</b>									
Date:	2015-06-15								
Notes:									
Author:	Wayne Yang								



**TAOGLAS**®

[www.taoglas.com](http://www.taoglas.com)



Компания «Океан Электроники» предлагает заключение долгосрочных отношений при поставках импортных электронных компонентов на взаимовыгодных условиях!

Наши преимущества:

- Поставка оригинальных импортных электронных компонентов напрямую с производств Америки, Европы и Азии, а так же с крупнейших складов мира;
- Широкая линейка поставок активных и пассивных импортных электронных компонентов (более 30 млн. наименований);
- Поставка сложных, дефицитных, либо снятых с производства позиций;
- Оперативные сроки поставки под заказ (от 5 рабочих дней);
- Экспресс доставка в любую точку России;
- Помощь Конструкторского Отдела и консультации квалифицированных инженеров;
- Техническая поддержка проекта, помощь в подборе аналогов, поставка прототипов;
- Поставка электронных компонентов под контролем ВП;
- Система менеджмента качества сертифицирована по Международному стандарту ISO 9001;
- При необходимости вся продукция военного и аэрокосмического назначения проходит испытания и сертификацию в лаборатории (по согласованию с заказчиком);
- Поставка специализированных компонентов военного и аэрокосмического уровня качества (Xilinx, Altera, Analog Devices, Intersil, Interpoint, Microsemi, Actel, Aeroflex, Peregrine, VPT, Syfer, Eurofarad, Texas Instruments, MS Kennedy, Miteq, Cobham, E2V, MA-COM, Hittite, Mini-Circuits, General Dynamics и др.);

Компания «Океан Электроники» является официальным дистрибьютором и эксклюзивным представителем в России одного из крупнейших производителей разъемов военного и аэрокосмического назначения «JONHON», а так же официальным дистрибьютором и эксклюзивным представителем в России производителя высокотехнологичных и надежных решений для передачи СВЧ сигналов «FORSTAR».



## JONHON

«JONHON» (основан в 1970 г.)

Разъемы специального, военного и аэрокосмического назначения:

(Применяются в военной, авиационной, аэрокосмической, морской, железнодорожной, горно- и нефтедобывающей отраслях промышленности)

«FORSTAR» (основан в 1998 г.)

ВЧ соединители, коаксиальные кабели, кабельные сборки и микроволновые компоненты:

(Применяются в телекоммуникациях гражданского и специального назначения, в средствах связи, РЛС, а так же военной, авиационной и аэрокосмической отраслях промышленности).



Телефон: 8 (812) 309-75-97 (многоканальный)

Факс: 8 (812) 320-03-32

Электронная почта: [ocean@oceanchips.ru](mailto:ocean@oceanchips.ru)

Web: <http://oceanchips.ru/>

Адрес: 198099, г. Санкт-Петербург, ул. Калинина, д. 2, корп. 4, лит. А