

Trimmer Potentiometers



EU RoHS Compliant

- All the products in this catalog comply with EU RoHS.
- EU RoHS is "the European Directive 2011/65/EU on the Restriction of the Use of Certain Hazardous Substances in Electrical and Electronic Equipment."
- For more details, please refer to our website 'Murata's Approach for EU RoHS' (<http://www.murata.com/info/rohs.html>).

CONTENTS

Part Numbering	_____	2
Selection Guide of Trimmer Potentiometers	_____	3
1 SMD Open Type 2mm Size PVZ2/PVA2 Series	_____	4
● PVZ2/PVA2 Series Notice	_____	8
2 SMD Open Type 3mm Size PVZ3 Series	_____	10
● PVZ3 Series Notice	_____	14
3 SMD Sealed Type 3mm Size PVG3 Series	_____	16
● PVG3 Series Notice	_____	19
4 SMD Sealed Type 4mm Size PVM4 Series	_____	21
● PVM4 Series Notice	_____	23
5 SMD Sealed Type Multi-turn PVG5 Series	_____	26
● PVG5 Series Notice	_____	29
6 Lead Sealed Type Single-turn PV32 Series	_____	31
● PV32 Series Notice	_____	34
7 Lead Sealed Type Multi-turn PV12/PV37/PV36 Series	_____	36
● PV12/PV37/PV36 Series Notice	_____	43
SMD Open Type (PVZ2/A2/Z3)/SMD Sealed Type (PVM4A_C01 Series) Specifications and Test Methods	_____	45
SMD Sealed Type (PVG3/M4A_D01/G5)/Lead Sealed Type (PV32/12/37/36) Specifications and Test Methods	_____	46
Packaging	_____	49
Recommended Adjustment Tools/Qualified Standards	_____	52

1

2

3

4

5

6

7

• The RoHS compliance means that we judge from EU Directive 2011/65/EU the products do not contain lead, cadmium, mercury, hexavalent chromium, PBB and PBDE, except exemptions stated in EU Directive 2011/65/EU annex and impurities existing in the natural world.
 • This statement does not insure the compliance of any of the listed parts with any laws or legal imperatives developed by any EU members individually with regards to the RoHS Directive.

● Part Numbering

Trimmer Potentiometers

(Part Number)

PV	Z3	A	103	C01	R00
①	②	③	④	⑤	⑥

① Product ID

Product ID	
PV	Trimmer Potentiometers

② Series

③ Adjustment Direction /Lead Type

Code	Series	Code	Adjustment Direction/ Lead Type
Z2	SMD Open 2mm Size Carbon Resistive Element	A	Top
		R	Rear
A2	SMD Open 2mm Size	A	Top
Z3	SMD Open 3mm Size Carbon Resistive Element	A	Top
		G	Top
		H	Top
G3	SMD Sealed 3mm Size	K	Rear
		A	Top, J-hook
M4	SMD Sealed 4mm Size	G	Top, Gull-wing
		A	Top
G5	SMD Sealed 5mm Square 11 turns	A	Top
		H	Side
32	Lead Sealed 6mm Round Single turn	H	Top, Triangle
		N	Side, Triangle
12	Lead Sealed 7mm Round 4 turns	P	Top, Triangle
		T	Side, Triangle
36	Lead Sealed 10mm Square 25 turns	W	Top, Inline
		X	Side, Inline
37	Lead Sealed 6mm Square 12 turns	W	Top, Triangle
		X	Side, Triangle

④ Total Resistance

Expressed by three figures. The unit is ohm. The first and second figures are significant digits, and the third figure expresses the number of zeros that follow the two figures.

Ex.)	Code	Total Resistance
	100	10Ω
	102	1000Ω
	104	100000Ω (=100kΩ)

⑤ Individual Specification

Series	Code	Individual Specification Code
PVA2	A01	Standard Type
PVZ2	C04	Standard Type (High-heat Resistance Type/Ultra-thin Type)
		C01
PVZ3	F01	High Characteristic Carbon Type (only PVZ3G)
	E01	High-heat Resistance Type (for Rear Adjustment)
PVM4	C01	Standard Type
	D01	High-reliability Type
PV32/PV12	A01	Standard Type
PVG3/ PV36/PV37	C01	Standard Type
PVG5	C03	Standard Type

⑥ Packaging

Code	Packaging
B00	Bulk
R00	Reel

Selection Guide of Trimmer Potentiometers



Trimmer Potentiometers



SMD Open Type 2mm Size PVZ2/PVA2 Series

PVZ2 Series

■ Features

1. Ultra-small and thin external dimensions of 2.1(W)x2.7(L)x0.85 max. (T)mm.
(Top adjustment type: PVZ2A_C04 Series)
2. Ultra-small and thin external dimensions of 2.1(W)x4.8(L)x0.9 max. (T)mm.
(Rear adjustment type: PVZ2R_C04 Series)
Compact PCB design is possible by smaller adjustment hole (3.0mm dia.) due to short wing length (4.8mm).
3. Au plated termination achieves a high-density PCB mounting.
4. Cross-shaped driver slot allows for in-process automatic adjustment and it provides superior adjustability.
5. Two-piece parts construction achieves low cost and excellent quality.
6. Special resin substrate allows high peak temperature for reflow soldering (PVZ2_Cxx Series).
7. PVZ2 series complies with RoHS directive.

■ Applications

- | | |
|-------------------|-------------------------|
| 1. Pick-up module | 6. DVC |
| 2. LCD | 7. Digital camera |
| 3. Cellular phone | 8. Portable audio, etc. |
| 4. PHS | 9. RKE |
| 5. Pager | 10. E-Book |



Part Number	Power Rating (W)	Number of Turns (Effective Rotation Angle)	Mechanical Rotation Angle	Total Resistance Value	TCR (ppm/°C)
PVZ2□471C04	0.05(50°C)	1(240°±10°)	Endless	470ohm±30%	±500
PVZ2□102C04	0.05(50°C)	1(240°±10°)	Endless	1k ohm±30%	±500
PVZ2□222C04	0.05(50°C)	1(240°±10°)	Endless	2.2k ohm±30%	±500
PVZ2□472C04	0.05(50°C)	1(240°±10°)	Endless	4.7k ohm±30%	±500
PVZ2□103C04	0.05(50°C)	1(240°±10°)	Endless	10k ohm±30%	±500
PVZ2□223C04	0.05(50°C)	1(240°±10°)	Endless	22k ohm±30%	±500
PVZ2□473C04	0.05(50°C)	1(240°±10°)	Endless	47k ohm±30%	±500
PVZ2□104C04	0.05(50°C)	1(240°±10°)	Endless	100k ohm±30%	±500
PVZ2□224C04	0.05(50°C)	1(240°±10°)	Endless	220k ohm±30%	±500
PVZ2□474C04	0.05(50°C)	1(240°±10°)	Endless	470k ohm±30%	±500
PVZ2□105C04	0.05(50°C)	1(240°±10°)	Endless	1M ohm±30%	±500

Operating Temperature Range: -25 to 85 °C
 Soldering Method: Reflow/Soldering Iron

■ Construction

PVZ2A



■ Standard Land Pattern

PVZ2A



(Tolerance : ±0.1 in mm)

■ Construction

PVZ2R

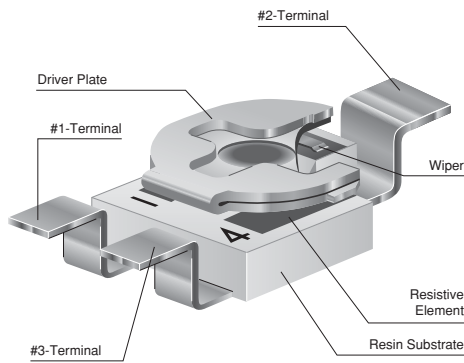

■ Standard Land Pattern

PVZ2R

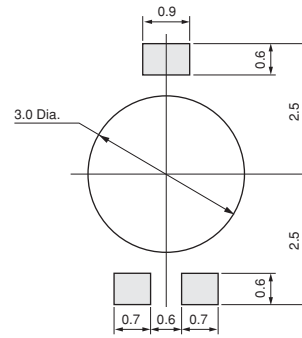

(Tolerance : ±0.1 in mm)

■ Characteristics

Humidity Exposure	Res. Change: +10, -2%
High Temperature Exposure	Res. Change: $R \leq 50\text{kohm} \cdots +2, -10\%$ $50\text{kohm} < R \cdots +2, -15\%$
Humidity Load Life	Res. Change: ±10%
Load Life	Res. Change: $R \leq 50\text{kohm} \cdots +2, -10\%$ $50\text{kohm} < R \cdots +2, -15\%$
Temperature Cycle	Res. Change: ±5%
Rotational Life	Res. Change: ±10% (10 cycles)

PVA2 Series

■ Features

1. Ultra-small and thin external dimensions of 2.2(W)x2.75(L)x0.90 max.(T)mm.
2. For the terminal attachment method of construction that uses neither solder nor adhesives, good solderability and terminal attachment intensity are realized.
3. Because of multi-contact wiper structure, PVA2 has a stable characteristics (low noise).
4. PVA2 series does not use a solder, flux or cleaning solvent, so they are environmentally friendly products.
5. Heat resistance performance enables high temperature peak reflow soldering.
6. PVA2 series complies with RoHS directive.



■ Applications

1. Thin-model optical pick-up module
2. LCD module
3. Optical communication module
4. Small sensor module
5. Digital camera
6. Small telecommunications equipment, etc.
7. E-Book

Part Number	Power Rating (W)	Number of Turns (Effective Rotation Angle)	Mechanical Rotation Angle	Total Resistance Value	TCR (ppm/°C)
PVA2A101A01	0.1(70°C)	1(260°±10°)	Endless	100ohm±25%	±250
PVA2A221A01	0.1(70°C)	1(260°±10°)	Endless	220ohm±25%	±250
PVA2A471A01	0.1(70°C)	1(260°±10°)	Endless	470ohm±25%	±250
PVA2A102A01	0.1(70°C)	1(260°±10°)	Endless	1k ohm±25%	±250
PVA2A222A01	0.1(70°C)	1(260°±10°)	Endless	2.2k ohm±25%	±250
PVA2A472A01	0.1(70°C)	1(260°±10°)	Endless	4.7k ohm±25%	±250
PVA2A103A01	0.1(70°C)	1(260°±10°)	Endless	10k ohm±25%	±250
PVA2A223A01	0.1(70°C)	1(260°±10°)	Endless	22k ohm±25%	±250
PVA2A473A01	0.1(70°C)	1(260°±10°)	Endless	47k ohm±25%	±250
PVA2A104A01	0.1(70°C)	1(260°±10°)	Endless	100k ohm±25%	±250
PVA2A224A01	0.1(70°C)	1(260°±10°)	Endless	220k ohm±25%	±250
PVA2A474A01	0.1(70°C)	1(260°±10°)	Endless	470k ohm±25%	±250
PVA2A105A01	0.1(70°C)	1(260°±10°)	Endless	1M ohm±25%	±250
PVA2A225A01	0.1(70°C)	1(260°±10°)	Endless	2.2M ohm±25%	±250

Operating Temperature Range: -55 to 125 °C
 Soldering Method: Reflow/Soldering Iron

■ Construction



■ Standard Land Pattern



(Tolerance : ±0.1 in mm)

■ Characteristics

Humidity Exposure	Res. Change: ±3%
High Temperature Exposure	Res. Change: ±3%
Humidity Load Life	Res. Change: ±3%
Load Life	Res. Change: ±3%
Temperature Cycle	Res. Change: ±3%
Rotational Life	Res. Change: ±10% (10 cycles)

■ Notice (Operating and Storage Conditions)

1. Store in temperatures of -10 to +40°C and relative humidity of 30-85%.
2. Do not store in or near corrosive gases.
3. Use within six months after delivery.
4. Open the package just before using.
5. Do not store under direct sunlight.
6. If you use the trimmer potentiometer in an environment other than listed at right, please consult with a Murata factory representative prior to using.

The trimmer potentiometer should not be used under the following environmental conditions:

- (1) Corrosive gaseous atmosphere
(Ex. Chlorine gas, Hydrogen sulfide gas, Ammonia gas, Sulfuric acid gas, Nitric oxide gas, etc.)
- (2) In liquid
(Ex. Oil, Medical liquid, Organic solvent, etc.)
- (3) Dusty/dirty atmosphere
- (4) Direct sunlight
- (5) Static voltage or electric/magnetic fields
- (6) Direct sea breeze
- (7) Other variations of the above

■ Notice (Rating)

1. When using with partial load (rheostat), minimize the power depending on the resistance value.
2. The maximum input voltage to a trimmer potentiometer should not exceed $(P \cdot R)^{1/2}$ or the maximum operating voltage, whichever is smaller.
3. If the trimmer potentiometer is used in DC and high humidity conditions, please connect wiper (#2) for plus and resistive element (#1 or #3) for minus.
(PVZ Series only)

■ Notice (Soldering and Mounting)

1. Soldering
 - (1) Reflow soldering method and soldering iron are available. This product cannot be soldered using the flow soldering method (dipping). If you use the flow soldering method, the trimmer potentiometer may not function.
 - (2) Use our standard land dimension. Excessive land area causes displacement due to the effect of the surface tension of the solder. Insufficient land area leads to insufficient soldering strength of the chip.
 - (3) Soldering conditions
Refer to the temperature profile.
If the soldering conditions are not suitable, e.g., excessive time and/or excessive temperature, the trimmer potentiometer may deviate from the specified characteristics.
 - (4) Apply the appropriate amount of solder paste.
The thickness of solder paste should be printed from 100 micro m to 150 micro m and the dimension of land pattern used should be Murata's standard land pattern at reflow soldering.
Insufficient amounts of solder can lead to insufficient soldering strength on PCB.
Excessive amounts of solder may cause bridging between the terminals.

- (5) The soldering iron should not come in contact with the case of the trimmer potentiometer. If such contact does occur, the trimmer potentiometer may be damaged.

2. Mounting

- (1) Do not apply excessive force, preferably 4.9N max. (Ref. 500gf) when the trimmer potentiometer is mounted to the PCB.
- (2) Do not warp and/or bend the PC board to protect trimmer potentiometer from breakage.
- (3) In chip placers, the recommended size of the cylindrical pick-up nozzle should be outer dimension 1.5-1.8mm dia. and inner dimension 1.3mm dia.

3. Cleaning

- (1) In case there is flux on the resistive element, clean sufficiently with cleaning solvents and completely remove all residual flux.
- (2) Isopropyl alcohol and ethyl alcohol are applicable solvents for cleaning. If you use any other types of solvents, please evaluate performance with your product.

Continued on the following page. 

PVZ2/PVA2 Series Notice

Continued from the preceding page.

■ Soldering Profile

● Reflow Soldering Profile

1. Soldering profile for lead free solder (96.5Sn/3.0Ag/0.5Cu)



Series	Standard Profile						Limit Profile					
	Pre-heating		Heating		Peak Temperature (T3)	Cycle of Reflow	Pre-heating		Heating		Peak Temperature (T5)	Cycle of Reflow
	Temp. (T1)	Time (t1)	Temp. (T2)	Time (t2)			Temp. (T1)	Time (t1)	Temp. (T4)	Time (t3)		
°C	sec.	°C	sec.	°C	Time	°C	sec.	°C	sec.	°C	Time	
PVZ2	150 to 180	60 to 120	220	30 to 60	245±3	2	150 to 180	60 to 120	220	30 to 60	260	2
PVA2	150 to 180	60 to 120	220	30 to 60	245±3	2	150 to 180	60 to 120	220	30 to 60	260 +5/-0	2

2. Soldering profile for Eutectic solder (63Sn/37Pb)

(Limit profile: refer to 1)



Series	Standard Profile					
	Pre-heating		Heating		Peak Temperature (T3)	Cycle of Reflow
	Temp. (T1)	Time (t1)	Temp. (T2)	Time (t2)		
°C	sec.	°C	sec.	°C	Time	
PVZ2 PVA2	150	60 to 120	183	30	230	1

● Soldering Iron

Series	Standard Condition			
	Temperature of Soldering Iron Tip	Soldering Time	Soldering Iron Power Output	Cycle of Soldering Iron
	°C	sec.	W	Time
PVZ2 PVA2	350±10	3 max.	30 max.	1

■ Notice (Handling)

- Use suitable screwdrivers that fit comfortably in the driver slot. We recommend the screwdriver below.
 * Recommended screwdriver for manual adjustment
 Murata P/N: KMDR190
- The screwdriver should be set in the products vertically, do not apply more than 4.9N (Ref. 500gf) of twist and stress after mounting onto PCB to prevent contact intermittence. If excessive force is applied, the trimmer potentiometer may not function.

- Please use within the effective rotational angle.
 The trimmer potentiometer does not have a mechanical stop for over rotation. In cases out of effective rotational angle, the trimmer potentiometer may not function.
- When using a lock paint to fix the slot position or cover the rotor, please evaluate performance with your product. Lock paint may cause corrosion or electrical contact problems.

■ Notice (Other)

- Please make sure that your product has been evaluated and confirmed against your specifications when our product is mounted to your product.
- Murata cannot guarantee trimmer potentiometer integrity when used under conditions other than those specified in this document.

Trimmer Potentiometers



SMD Open Type 3mm Size PVZ3 Series

2

PVZ3 Series

■ Features

1. Excellent solderability characteristics are achieved via special plating techniques on each termination.
2. Specially designed substrate prevents wicking of flux onto the top of the part body.
3. Funnel shaped adjustment slot allows for in-process automatic adjustment.
(PVZ3A/PVZ3H/PVZ3K Series)
4. High-heat resistance type is available
(PVZ3A_C01/PVZ3K_E01).
5. Enlarged bottom termination enhances soldering strength while reducing the necessary land area required, promoting high-density PCB mounting
(PVZ3A/PVZ3H/PVZ3G Series).
6. The standard position of the driver plate is adjusted at the center normally, but another position is also available.
7. This product meets PB-free standards.
8. Complies with RoHS directive.

■ Applications

- | | |
|------------------------|----------------------|
| 1. Optical pick up | 6. CD-ROMs |
| 2. Cordless telephones | 7. Car stereos |
| 3. CD players | 8. TFT-LCD TV sets |
| 4. E-Book | 9. Headphone stereos |
| 5. Motor | |



PVZ3A



PVZ3H



PVZ3G



PVZ3K



Top Adjustment (H 1.85)

Part Number	Power Rating (W)	Number of Turns (Effective Rotation Angle)	Mechanical Rotation Angle	Total Resistance Value	TCR (ppm/°C)
PVZ3A221C01	0.1(50°C)	1(230°±10°)	Endless	220ohm±30%	±500
PVZ3A471C01	0.1(50°C)	1(230°±10°)	Endless	470ohm±30%	±500
PVZ3A102C01	0.1(50°C)	1(230°±10°)	Endless	1k ohm±30%	±500
PVZ3A222C01	0.1(50°C)	1(230°±10°)	Endless	2.2k ohm±30%	±500
PVZ3A472C01	0.1(50°C)	1(230°±10°)	Endless	4.7k ohm±30%	±500
PVZ3A103C01	0.1(50°C)	1(230°±10°)	Endless	10k ohm±30%	±500
PVZ3A223C01	0.1(50°C)	1(230°±10°)	Endless	22k ohm±30%	±500
PVZ3A473C01	0.1(50°C)	1(230°±10°)	Endless	47k ohm±30%	±500
PVZ3A104C01	0.1(50°C)	1(230°±10°)	Endless	100k ohm±30%	±500
PVZ3A224C01	0.1(50°C)	1(230°±10°)	Endless	220k ohm±30%	±500
PVZ3A474C01	0.1(50°C)	1(230°±10°)	Endless	470k ohm±30%	±500
PVZ3A105C01	0.1(50°C)	1(230°±10°)	Endless	1M ohm±30%	±500
PVZ3A225C01	0.1(50°C)	1(230°±10°)	Endless	2.2M ohm±30%	±500

Operating Temperature Range: -25 to 85 °C
 Soldering Method: Reflow/Soldering Iron

Top Adjustment (H 1.55)

Part Number	Power Rating (W)	Number of Turns (Effective Rotation Angle)	Mechanical Rotation Angle	Total Resistance Value	TCR (ppm/°C)
PVZ3H221C01	0.1(50°C)	1(230°±10°)	Endless	220ohm±30%	±500
PVZ3H471C01	0.1(50°C)	1(230°±10°)	Endless	470ohm±30%	±500
PVZ3H102C01	0.1(50°C)	1(230°±10°)	Endless	1k ohm±30%	±500
PVZ3H222C01	0.1(50°C)	1(230°±10°)	Endless	2.2k ohm±30%	±500
PVZ3H472C01	0.1(50°C)	1(230°±10°)	Endless	4.7k ohm±30%	±500
PVZ3H103C01	0.1(50°C)	1(230°±10°)	Endless	10k ohm±30%	±500
PVZ3H223C01	0.1(50°C)	1(230°±10°)	Endless	22k ohm±30%	±500
PVZ3H473C01	0.1(50°C)	1(230°±10°)	Endless	47k ohm±30%	±500
PVZ3H104C01	0.1(50°C)	1(230°±10°)	Endless	100k ohm±30%	±500
PVZ3H224C01	0.1(50°C)	1(230°±10°)	Endless	220k ohm±30%	±500
PVZ3H474C01	0.1(50°C)	1(230°±10°)	Endless	470k ohm±30%	±500
PVZ3H105C01	0.1(50°C)	1(230°±10°)	Endless	1M ohm±30%	±500
PVZ3H225C01	0.1(50°C)	1(230°±10°)	Endless	2.2M ohm±30%	±500

Operating Temperature Range: -25 to 85 °C
 Soldering Method: Reflow/Soldering Iron

Top Adjustment and Thin Type (H 1.15)

Part Number	Power Rating (W)	Number of Turns (Effective Rotation Angle)	Mechanical Rotation Angle	Total Resistance Value	TCR (ppm/°C)
PVZ3G221C01	0.1(50°C)	1(230°±10°)	Endless	220ohm±30%	±500
PVZ3G471C01	0.1(50°C)	1(230°±10°)	Endless	470ohm±30%	±500
PVZ3G102C01	0.1(50°C)	1(230°±10°)	Endless	1k ohm±30%	±500
PVZ3G222C01	0.1(50°C)	1(230°±10°)	Endless	2.2k ohm±30%	±500
PVZ3G472C01	0.1(50°C)	1(230°±10°)	Endless	4.7k ohm±30%	±500
PVZ3G103C01	0.1(50°C)	1(230°±10°)	Endless	10k ohm±30%	±500
PVZ3G223C01	0.1(50°C)	1(230°±10°)	Endless	22k ohm±30%	±500
PVZ3G473C01	0.1(50°C)	1(230°±10°)	Endless	47k ohm±30%	±500
PVZ3G104C01	0.1(50°C)	1(230°±10°)	Endless	100k ohm±30%	±500
PVZ3G224C01	0.1(50°C)	1(230°±10°)	Endless	220k ohm±30%	±500
PVZ3G474C01	0.1(50°C)	1(230°±10°)	Endless	470k ohm±30%	±500
PVZ3G105C01	0.1(50°C)	1(230°±10°)	Endless	1M ohm±30%	±500
PVZ3G225C01	0.1(50°C)	1(230°±10°)	Endless	2.2M ohm±30%	±500

Operating Temperature Range: -25 to 85 °C
 Soldering Method: Reflow/Soldering Iron

Rear Adjustment

2

Part Number	Power Rating (W)	Number of Turns (Effective Rotation Angle)	Mechanical Rotation Angle	Total Resistance Value	TCR (ppm/°C)
PVZ3K221E01	0.1(50°C)	1(230°±10°)	Endless	220ohm±30%	±500
PVZ3K471E01	0.1(50°C)	1(230°±10°)	Endless	470ohm±30%	±500
PVZ3K102E01	0.1(50°C)	1(230°±10°)	Endless	1k ohm±30%	±500
PVZ3K222E01	0.1(50°C)	1(230°±10°)	Endless	2.2k ohm±30%	±500
PVZ3K472E01	0.1(50°C)	1(230°±10°)	Endless	4.7k ohm±30%	±500
PVZ3K103E01	0.1(50°C)	1(230°±10°)	Endless	10k ohm±30%	±500
PVZ3K223E01	0.1(50°C)	1(230°±10°)	Endless	22k ohm±30%	±500
PVZ3K473E01	0.1(50°C)	1(230°±10°)	Endless	47k ohm±30%	±500
PVZ3K104E01	0.1(50°C)	1(230°±10°)	Endless	100k ohm±30%	±500
PVZ3K224E01	0.1(50°C)	1(230°±10°)	Endless	220k ohm±30%	±500
PVZ3K474E01	0.1(50°C)	1(230°±10°)	Endless	470k ohm±30%	±500
PVZ3K105E01	0.1(50°C)	1(230°±10°)	Endless	1M ohm±30%	±500
PVZ3K225E01	0.1(50°C)	1(230°±10°)	Endless	2.2M ohm±30%	±500

Operating Temperature Range: -25 to 85 °C
 Soldering Method: Reflow/Soldering Iron

Construction



Construction



Standard Land Pattern

PVZ3A/PVZ3G/PVZ3H



(Tolerance : ±0.1 in mm)

Construction



Continued on the following page. ↗

Continued from the preceding page.

■ Construction



■ Standard Land Pattern



(Tolerance : ±0.1 in mm)

■ Characteristics

Humidity Exposure	Res. Change: +10, -2%
High Temperature Exposure	Res. Change: $R \leq 100\text{kohm}$: +2, -10% $100\text{kohm} < R$: +2, -15%
Humidity Load Life	Res. Change: ±10%
Load Life	Res. Change: $R \leq 100\text{kohm}$: +2, -10% $100\text{kohm} < R$: +2, -15%
Temperature Cycle	Res. Change: ±5%
Rotational Life	Res. Change: ±10% (10 cycles)

2

PVZ3 Series Notice

2

■ Notice (Operating and Storage Conditions)

1. Store in temperatures of -10 to +40°C and relative humidity of 30-85%.
2. Do not store in or near corrosive gases.
3. Use within six months after delivery.
4. Open the package just before using.
5. Do not store under direct sunlight.
6. If you use the trimmer potentiometer in an environment other than listed at right, please consult with a Murata factory representative prior to using.

The trimmer potentiometer should not be used under the following environmental conditions:

- (1) Corrosive gaseous atmosphere
(Ex. Chlorine gas, Hydrogen sulfide gas, Ammonia gas, Sulfuric acid gas, Nitric oxide gas, etc.)
- (2) In liquid
(Ex. Oil, Medical liquid, Organic solvent, etc.)
- (3) Dusty/dirty atmosphere
- (4) Direct sunlight
- (5) Static voltage or electric/magnetic fields
- (6) Direct sea breeze
- (7) Other variations of the above

■ Notice (Rating)

1. When using with partial load (rheostat), minimize the power depending on the resistance value.
2. The maximum input voltage to a trimmer potentiometer should not exceed $(P \cdot R)^{1/2}$ or the maximum operating voltage, whichever is smaller.
3. If the trimmer potentiometer is used in DC and high humidity conditions, please connect wiper (#2) for plus and resistive element (#1 or #3) for minus.

■ Notice (Soldering and Mounting)

1. Soldering
 - (1) Soldering conditions
Refer to the temperature profile.
If the soldering conditions are not suitable, e.g., excessive time and/or excessive temperature, the trimmer potentiometer may deviate from the specified characteristics.
Do not use flow soldering method (dipping).
If you use the flow soldering method, the trimmer potentiometer may not function.
 - (2) Use our standard land dimension. Excessive land area causes displacement due to the effect of the surface tension of the solder. Insufficient land area leads to insufficient soldering strength of the chip.
 - (3) Apply the appropriate amount of solder paste.
The thickness of solder paste should be printed from 100 micro m to 150 micro m and the dimension of land pattern used should be Murata's standard land pattern at reflow soldering. Insufficient amounts of solder can lead to insufficient soldering strength on PCB.
Excessive amounts of solder may cause bridging between the terminals.

- (4) The soldering iron should not come in contact with the case of the trimmer potentiometer. If such contact does occur, the trimmer potentiometer may be damaged. (PVZ Series only)

2. Mounting

- (1) Do not apply excessive force, preferably 4.9N max. (Ref. 500gf) when the trimmer potentiometer is mounted to the PCB.
- (2) Do not warp and/or bend the PC board to protect trimmer potentiometer from breakage.
- (3) In chip placers, the recommended size of the cylindrical pick-up nozzle should be outer dimension 2.5-2.8mm dia. and inner dimension 2mm dia.

3. Cleaning

- (1) In case there is flux on the resistive element, clean sufficiently with cleaning solvents and completely remove all residual flux.
- (2) Isopropyl alcohol and ethyl alcohol are applicable solvents for cleaning. If you use any other types of solvents, please evaluate performance with your product.

Continued on the following page. 

PVZ3 Series Notice

☐ Continued from the preceding page.

■ Soldering Profile

● Reflow Soldering Profile

1. Soldering profile for lead free solder (96.5Sn/3.0Ag/0.5Cu)



Series	Standard Profile						Limit Profile					
	Pre-heating		Heating		Peak Temperature (T3)	Cycle of Reflow	Pre-heating		Heating		Peak Temperature (T5)	Cycle of Reflow
	Temp. (T1)	Time (t1)	Temp. (T2)	Time (t2)			Temp. (T1)	Time (t1)	Temp. (T4)	Time (t3)		
°C	sec.	°C	sec.	°C	Time	°C	sec.	°C	sec.	°C	Time	
PVZ3	150 to 180	60 to 120	220	30 to 60	245±3	2	150 to 180	60 to 120	220	30 to 60	260	2

2. Soldering profile for Eutectic solder (63Sn/37Pb)

(Limit profile: refer to 1)



Series	Standard Profile					
	Pre-heating		Heating		Peak Temperature (T3)	Cycle of Reflow
	Temp. (T1)	Time (t1)	Temp. (T2)	Time (t2)		
°C	sec.	°C	sec.	°C	Time	
PVZ3	150	60 to 120	183	30	230 max.	1

● Soldering Iron

Series	Standard Condition			
	Temperature of Soldering Iron Tip	Soldering Time	Soldering Iron Power Output	Cycle of Soldering Iron
	°C	sec.	W	Time
PVZ3	350±10	3 max.	30 max.	1

■ Notice (Handling)

1. Use suitable screwdrivers that fit comfortably in the driver slot. We recommend the screwdrivers below.

* Recommended screwdriver for manual adjustment
 >VESSEL MFG.: NO.9000+1.7x30
 (Murata P/N: KMDR080)

* Recommended screwdriver for automatic adjustment
 >TORAY MFG.: JB-2225 (Murata P/N: KMBT070)

2. Don't apply more than 4.9N (Ref.: 500gf) of twist and stress after mounting onto PCB to prevent contact intermittence. If excessive force is applied, the trimmer potentiometer may not function.

3. Please use within the effective rotational angle. Do not have a mechanical stop for over rotation. In cases out of effective rotational angle, the trimmer potentiometer may not function.

4. When using a lock paint to fix the slot position or cover the rotor, please evaluate performance with your product. Lock paint may cause corrosion or electrical contact problems.

■ Notice (Other)

1. Please make sure that your product has been evaluated and confirmed against your specifications when our product is mounted to your product.

2. Murata cannot guarantee trimmer potentiometer integrity when used under conditions other than those specified in this document.

Trimmer Potentiometers



SMD Sealed Type 3mm Size PVG3 Series

■ Features

1. Sealed construction protects the interior from dust and liquid, which achieves stable performance.
2. Driver plate with cross-slot is suitable for automatic adjustment.
3. Rotor with large diameter and deep groove improves driver insertion.
4. 3mm and 4mm land pattern can be used without change. (Gull-wing is suitable for 4mm size land pattern.)
5. Heat resistance performance enables high temperature peak reflow soldering.
6. Complies with RoHS directive by new Cd free cermet resistive material. Pb free terminals with Sn plating.

■ Applications

- | | |
|-------------------------------|--------------------------|
| 1. Small sensors | 5. Compact Power Supply |
| 2. Optical Transceiver Module | 6. Wireless Radio module |
| 3. Copier | 7. Corner Sensor |
| 4. Printer | 8. E-Book |



Top Adjustment (Standard Type)

Part Number	Power Rating (W)	Number of Turns (Effective Rotation Angle)	Mechanical Rotation Angle	Total Resistance Value	TCR (ppm/°C)
PVG3A100C01	0.25(70°C)	1(210°±10°)	250+/-10 deg.	10ohm±20%	±150
PVG3A200C01	0.25(70°C)	1(210°±10°)	250+/-10 deg.	20ohm±20%	±150
PVG3A500C01	0.25(70°C)	1(210°±10°)	250+/-10 deg.	50ohm±20%	±150
PVG3A101C01	0.25(70°C)	1(210°±10°)	250+/-10 deg.	100ohm±20%	±150
PVG3A201C01	0.25(70°C)	1(210°±10°)	250+/-10 deg.	200ohm±20%	±150
PVG3A501C01	0.25(70°C)	1(210°±10°)	250+/-10 deg.	500ohm±20%	±150
PVG3A102C01	0.25(70°C)	1(210°±10°)	250+/-10 deg.	1k ohm±20%	±150
PVG3A202C01	0.25(70°C)	1(210°±10°)	250+/-10 deg.	2k ohm±20%	±150
PVG3A502C01	0.25(70°C)	1(210°±10°)	250+/-10 deg.	5k ohm±20%	±150
PVG3A103C01	0.25(70°C)	1(210°±10°)	250+/-10 deg.	10k ohm±20%	±150
PVG3A203C01	0.25(70°C)	1(210°±10°)	250+/-10 deg.	20k ohm±20%	±150
PVG3A503C01	0.25(70°C)	1(210°±10°)	250+/-10 deg.	50k ohm±20%	±150
PVG3A104C01	0.25(70°C)	1(210°±10°)	250+/-10 deg.	100k ohm±20%	±150
PVG3A204C01	0.25(70°C)	1(210°±10°)	250+/-10 deg.	200k ohm±20%	±150
PVG3A504C01	0.25(70°C)	1(210°±10°)	250+/-10 deg.	500k ohm±20%	±150
PVG3A105C01	0.25(70°C)	1(210°±10°)	250+/-10 deg.	1M ohm±20%	±150
PVG3A205C01	0.25(70°C)	1(210°±10°)	250+/-10 deg.	2M ohm±20%	±150

Operating Temperature Range: -55 to 125 °C
 Soldering Method: Reflow/Soldering Iron

Top Adjustment (Gull-Wing Type)

Part Number	Power Rating (W)	Number of Turns (Effective Rotation Angle)	Mechanical Rotation Angle	Total Resistance Value	TCR (ppm/°C)
PVG3G100C01	0.25(70°C)	1(210°±10°)	250+/-10 deg.	10ohm±20%	±150
PVG3G200C01	0.25(70°C)	1(210°±10°)	250+/-10 deg.	20ohm±20%	±150
PVG3G500C01	0.25(70°C)	1(210°±10°)	250+/-10 deg.	50ohm±20%	±150
PVG3G101C01	0.25(70°C)	1(210°±10°)	250+/-10 deg.	100ohm±20%	±150
PVG3G201C01	0.25(70°C)	1(210°±10°)	250+/-10 deg.	200ohm±20%	±150
PVG3G501C01	0.25(70°C)	1(210°±10°)	250+/-10 deg.	500ohm±20%	±150
PVG3G102C01	0.25(70°C)	1(210°±10°)	250+/-10 deg.	1k ohm±20%	±150
PVG3G202C01	0.25(70°C)	1(210°±10°)	250+/-10 deg.	2k ohm±20%	±150
PVG3G502C01	0.25(70°C)	1(210°±10°)	250+/-10 deg.	5k ohm±20%	±150
PVG3G103C01	0.25(70°C)	1(210°±10°)	250+/-10 deg.	10k ohm±20%	±150
PVG3G203C01	0.25(70°C)	1(210°±10°)	250+/-10 deg.	20k ohm±20%	±150
PVG3G503C01	0.25(70°C)	1(210°±10°)	250+/-10 deg.	50k ohm±20%	±150
PVG3G104C01	0.25(70°C)	1(210°±10°)	250+/-10 deg.	100k ohm±20%	±150
PVG3G204C01	0.25(70°C)	1(210°±10°)	250+/-10 deg.	200k ohm±20%	±150
PVG3G504C01	0.25(70°C)	1(210°±10°)	250+/-10 deg.	500k ohm±20%	±150
PVG3G105C01	0.25(70°C)	1(210°±10°)	250+/-10 deg.	1M ohm±20%	±150
PVG3G205C01	0.25(70°C)	1(210°±10°)	250+/-10 deg.	2M ohm±20%	±150

Operating Temperature Range: -55 to 125 °C
 Soldering Method: Reflow/Soldering Iron

3

Construction



Standard Land Pattern



(Tolerance : ±0.1 in mm)



(Tolerance : ±0.1 in mm)

■ Characteristics

Temperature Cycle	ΔTR : $\pm 2\%$ $\Delta V.S.S.$: $\pm 1\%$
Humidity	ΔTR : $\pm 2\%$ $\Delta V.S.S.$: $\pm 1\%$ IR : 10M ohm min.
Vibration (20G)	ΔTR : $\pm 1\%$ $\Delta V.S.S.$: $\pm 1\%$
Shock (100G)	ΔTR : $\pm 1\%$ $\Delta V.S.S.$: $\pm 1\%$
Temperature Load Life	ΔTR : $\pm 3\%$ or 3 ohm max., whichever is greater $\Delta V.S.S.$: $\pm 1\%$
Low Temperature Exposure	ΔTR : $\pm 2\%$ $\Delta V.S.S.$: $\pm 2\%$
High Temperature Exposure	ΔTR : $\pm 3\%$ $\Delta V.S.S.$: $\pm 2\%$
Rotational Life	ΔTR : $R \leq 100 \text{ kohm} \dots \pm 3\%$ or 2 ohm max., whichever is greater $R > 100 \text{ kohm} \dots +0/-10\%$ (50 cycles)

ΔTR : Total Resistance Change
 $\Delta V.S.S.$: Voltage Setting Stability
 IR : Insulation Resistance
 R : Standard Total Resistance

PVG3 Series Notice

■ Notice (Operating and Storage Conditions)

1. Store in temperatures of -10 to +40°C and relative humidity of 30-85%.
2. Do not store in or near corrosive gases.
3. Use within six months after delivery.
4. Open the package just before using.
5. Do not store under direct sunlight.
6. If you use the trimmer potentiometer in an environment other than listed at right, please consult with a Murata factory representative prior to using.

The trimmer potentiometer should not be used under the following environmental conditions:

- (1) Corrosive gaseous atmosphere
(Ex. Chlorine gas, Hydrogen sulfide gas, Ammonia gas, Sulfuric acid gas, Nitric oxide gas, etc.)
- (2) In liquid
(Ex. Oil, Medical liquid, Organic solvent, etc.)
- (3) Dusty/dirty atmosphere
- (4) Direct sunlight
- (5) Static voltage or electric/magnetic fields
- (6) Direct sea breeze
- (7) Other variations of the above

■ Notice (Rating)

1. When using with partial load (rheostat), minimize the power depending on the resistance value.
2. The maximum input voltage to a trimmer potentiometer should not exceed $(P \cdot R)^{1/2}$ or the maximum operating voltage, whichever is smaller.

■ Notice (Soldering and Mounting)

1. Soldering
 - (1) Soldering conditions
Refer to the temperature profile.
If the soldering conditions are not suitable, e.g., excessive time and/or excessive temperature, the trimmer potentiometer may deviate from the specified characteristics.
 - (2) This product cannot be soldered using the flow soldering method. If you use the flow soldering method, the trimmer potentiometer may not function.
 - (3) The soldering iron should not come in contact with the case of the trimmer potentiometer. If such contact does occur, the trimmer potentiometer may be damaged.
 - (4) Apply the appropriate amount of solder paste.
If the amount of solder paste applied to the land is insufficient, the required adhesive strength cannot be obtained. If an excessive amount of solder paste is applied, solder bridging or flux overflow to the resistive element surface can occur.

2. Mounting
 - (1) Use our standard land dimension. Excessive land area causes displacement due to the effect of the surface tension of the solder. Insufficient land area leads to insufficient soldering strength of the chip.
 - (2) Do not apply excessive force, preferably 4.9N max. (Ref. 500gf) when the trimmer potentiometer is mounted to the PCB.
 - (3) Do not warp and/or bend the PC board to protect trimmer potentiometer from breakage.
 - (4) In chip placers, the size of the cylindrical pick-up nozzle should be outer dimension 2.5-3.0mm dia. and inner dimension 2.0-2.5mm dia.
3. Cleaning
Isopropyl alcohol and ethyl alcohol are applicable solvents for cleaning. If you use any other types of solvents, please consult with a Murata factory representative prior to using.

Continued on the following page. 

PVG3 Series Notice

☐ Continued from the preceding page.

■ Soldering Profile

● Reflow Soldering Profile

1. Soldering profile for lead free solder (96.5Sn/3.0Ag/0.5Cu)



Series	Standard Profile						Limit Profile					
	Pre-heating		Heating		Peak Temperature (T3)	Cycle of Reflow	Pre-heating		Heating		Peak Temperature (T5)	Cycle of Reflow
	Temp. (T1)	Time (t1)	Temp. (T2)	Time (t2)			Temp. (T1)	Time (t1)	Temp. (T4)	Time (t3)		
°C	sec.	°C	sec.	°C	Time	°C	sec.	°C	sec.	°C	Time	
PVG3	150 to 180	60 to 120	220	30 to 60	245±3	1	150 to 180	60 to 120	230	30 to 50	260 +5/-0	2

2. Soldering profile for Eutectic solder (63Sn/37Pb)

(Limit profile: refer to 1)



Series	Standard Profile					
	Pre-heating		Heating		Peak Temperature (T3)	Cycle of Reflow
	Temp. (T1)	Time (t1)	Temp. (T2)	Time (t2)		
°C	sec.	°C	sec.	°C	Time	
PVG3	150	60 to 120	183	30	230	1

● Soldering Iron

Series	Standard Condition			
	Temperature of Soldering Iron Tip	Soldering Time	Soldering Iron Power Output	Cycle of Soldering Iron
	°C	sec.	W	Time
PVG3	350±10	3 max.	30 max.	1

■ Notice (Handling)

1. Use suitable screwdrivers that fit comfortably in the driver slot.

* Recommended screwdriver for manual adjustment
 TORAY INDUSTRIES, INC.: SA-2225
 (Murata P/N: KMDR070)

* Recommended screwdriver bit for automatic adjustment
 TORAY INDUSTRIES, INC.: JB-2225
 (Murata P/N: KMBT070)

We can supply the screwdrivers above.

If you place an order, please specify the Murata P/N.

2. When adjusting with an adjustment tool, the applied force to the adjustment screw should not exceed 4.9N (Ref. 500gf). If excessive force is applied, the trimmer potentiometer may not function due to damage.

3. The rotational torque at the position of the adjustment range should not exceed the stop strength.

4. When using a lock paint to fix the slot position, please use adhesive resin without chlorine or sulfur (Three-bond "1401 series") and evaluate performance with your product. Lock paint may cause corrosion or electrical contact problems.

■ Notice (Other)

1. Please make sure that your product has been evaluated and confirmed against your specifications when our product is mounted to your product.

2. Murata cannot guarantee trimmer potentiometer integrity when used under conditions other than those specified in this document.

Trimmer Potentiometers



SMD Sealed Type 4mm Size PVM4 Series

■ Features

1. Sealed construction protects the interior from dust and liquid, which achieves stable performance.
2. Available for flow and reflow soldering methods while maintaining unique sealed construction.
3. Simple construction of 3-piece parts achieves high reliability.
4. Large diameter slot of rotor improves driver insertion.
5. Available for cleaning after soldering.
6. High grade version is available (PVM4AxxxD01).
7. Complies with RoHS directive by new Cd free cermet resistive material. Pb free terminals with Sn plating.



■ Applications

1. Security
2. OA, FA equipment
3. Measuring equipment
4. Professional cameras
5. Encoders
6. Sensors
7. RKE

Top Adjustment (Standard Type)

Part Number	Power Rating (W)	Number of Turns (Effective Rotation Angle)	Mechanical Rotation Angle	Total Resistance Value	TCR (ppm/°C)
PVM4A101C01	0.1(70°C)	1(240°±10°)	Endless	100ohm±25%	±250
PVM4A201C01	0.1(70°C)	1(240°±10°)	Endless	200ohm±25%	±250
PVM4A501C01	0.1(70°C)	1(240°±10°)	Endless	500ohm±25%	±250
PVM4A102C01	0.1(70°C)	1(240°±10°)	Endless	1k ohm±25%	±250
PVM4A202C01	0.1(70°C)	1(240°±10°)	Endless	2k ohm±25%	±250
PVM4A502C01	0.1(70°C)	1(240°±10°)	Endless	5k ohm±25%	±250
PVM4A103C01	0.1(70°C)	1(240°±10°)	Endless	10k ohm±25%	±250
PVM4A203C01	0.1(70°C)	1(240°±10°)	Endless	20k ohm±25%	±250
PVM4A503C01	0.1(70°C)	1(240°±10°)	Endless	50k ohm±25%	±250
PVM4A104C01	0.1(70°C)	1(240°±10°)	Endless	100k ohm±25%	±250
PVM4A204C01	0.1(70°C)	1(240°±10°)	Endless	200k ohm±25%	±250
PVM4A504C01	0.1(70°C)	1(240°±10°)	Endless	500k ohm±25%	±250
PVM4A105C01	0.1(70°C)	1(240°±10°)	Endless	1M ohm±25%	±250
PVM4A205C01	0.1(70°C)	1(240°±10°)	Endless	2M ohm±25%	±250

Operating Temperature Range: -55 to 125 °C
 Soldering Method: Flow/Reflow/Soldering Iron

Top Adjustment (High-Liability Type)

Part Number	Power Rating (W)	Number of Turns (Effective Rotation Angle)	Mechanical Rotation Angle	Total Resistance Value	TCR (ppm/°C)
PVM4A101D01	0.25(70°C)	1(240°±10°)	Endless	100ohm±20%	±100
PVM4A201D01	0.25(70°C)	1(240°±10°)	Endless	200ohm±20%	±100
PVM4A501D01	0.25(70°C)	1(240°±10°)	Endless	500ohm±20%	±100
PVM4A102D01	0.25(70°C)	1(240°±10°)	Endless	1k ohm±20%	±200
PVM4A202D01	0.25(70°C)	1(240°±10°)	Endless	2k ohm±20%	±200
PVM4A502D01	0.25(70°C)	1(240°±10°)	Endless	5k ohm±20%	±200
PVM4A103D01	0.25(70°C)	1(240°±10°)	Endless	10k ohm±20%	±150
PVM4A203D01	0.25(70°C)	1(240°±10°)	Endless	20k ohm±20%	±150
PVM4A503D01	0.25(70°C)	1(240°±10°)	Endless	50k ohm±20%	±150
PVM4A104D01	0.25(70°C)	1(240°±10°)	Endless	100k ohm±20%	±150
PVM4A204D01	0.25(70°C)	1(240°±10°)	Endless	200k ohm±20%	±150
PVM4A504D01	0.25(70°C)	1(240°±10°)	Endless	500k ohm±20%	±150
PVM4A105D01	0.25(70°C)	1(240°±10°)	Endless	1M ohm±20%	±150
PVM4A205D01	0.25(70°C)	1(240°±10°)	Endless	2M ohm±20%	±150

Operating Temperature Range: -55 to 125 °C
 Soldering Method: Flow/Reflow/Soldering Iron

4

Construction



Standard Land Pattern



Characteristics

Item	PVM4A□□□C01	PVM4A□□□D01
Humidity Exposure	Res. Change: ±3%	Res. Change: ±2%
High Temperature Exposure	Res. Change: ±3%	Res. Change: ±2%
Humidity Load Life	Res. Change: ±3%	Res. Change: ±3%
Temperature Load Life	Res. Change: ±3%	Res. Change: ±3%
Temperature Cycle	Res. Change: ±3%	Res. Change: ±2%
Rotational Life	Res. Change: ±10% (20 cycles)	Res. Change: ±5% (100 cycles)

PVM4 Series Notice

■ Notice (Operating and Storage Conditions)

1. Store in temperatures of -10 to +40°C and relative humidity of 30-85%.
2. Do not store in or near corrosive gases.
3. Use within six months after delivery.
4. Open the package just before using.
5. Do not store under direct sunlight.
6. If you use the trimmer potentiometer in an environment other than listed at right, please consult with a Murata factory representative prior to using.

The trimmer potentiometer should not be used under the following environmental conditions:

- (1) Corrosive gaseous atmosphere
(Ex. Chlorine gas, Hydrogen sulfide gas, Ammonia gas, Sulfuric acid gas, Nitric oxide gas, etc.)
- (2) In liquid
(Ex. Oil, Medical liquid, Organic solvent, etc.)
- (3) Dusty/dirty atmosphere
- (4) Direct sunlight
- (5) Static voltage or electric/magnetic fields
- (6) Direct sea breeze
- (7) Other variations of the above

■ Notice (Rating)

1. When using with partial load (rheostat), minimize the power depending on the resistance value.
2. The maximum input voltage to a trimmer potentiometer should not exceed $(P \cdot R)^{1/2}$ or the maximum operating voltage, whichever is smaller.

■ Notice (Soldering and Mounting)

1. Soldering
 - (1) Can be soldered by reflow soldering method, flow soldering method, and soldering iron.
 - (2) Use our standard land dimension. Excessive land area causes displacement due to the effect of the surface tension of the solder. Insufficient land area leads to insufficient soldering strength of the chip.
 - (3) Soldering conditions
Refer to the temperature profile.
If the soldering conditions are not suitable, e.g., excessive time and/or excessive temperature, the trimmer potentiometer may deviate from the specified characteristics.
 - (4) Apply the appropriate amount of solder paste.
The thickness of solder paste should be printed from 100 micro m to 150 micro m and the dimension of land pattern used should be Murata's standard land pattern at reflow soldering. Insufficient amounts of solder can lead to insufficient soldering strength on PCB. Excessive amounts of solder may cause bridging between the terminals.

- (5) The soldering iron should not come in contact with the case of the trimmer potentiometer. If such contact does occur, the trimmer potentiometer may be damaged.

2. Mounting

- (1) Do not apply excessive force, preferably 9.8N max. (Ref. 1kgf) when the trimmer potentiometer is mounted to the PCB.
- (2) Do not warp and/or bend the PC board to protect trimmer potentiometer from breakage.
- (3) In chip placers, the recommended size of the cylindrical pick-up nozzle should be outer dimension 4.0mm dia. and inner dimension 2.0mm dia.

3. Cleaning

Isopropyl alcohol and ethyl alcohol are available materials for cleaning.
For other materials, please consult with a Murata factory representative prior to using.

Continued on the following page. 

PVM4 Series Notice

☐ Continued from the preceding page.

■ Soldering Profile

● Flow Soldering Profile

Soldering profile for lead free solder (96.5Sn/3.0Ag/0.5Cu), Eutectic solder (63Sn/37Pb)



Series	Standard Profile					Limit Profile				
	Pre-heating		Heating		Cycle of Flow	Pre-heating		Heating		Cycle of Flow
	Temp. (T1) °C	Time (t1) sec.	Temp. (T2) °C	Time (t2) sec.		Temp. (T1) °C	Time (t1) sec.	Temp. (T3) °C	Time (t2) sec.	
PVM4	150	60 to 120	250	5 max.	1	150	60 to 120	265±3	5 max.	2

● Reflow Soldering Profile

1. Soldering profile for Lead-free solder (96.5Sn/3.0Ag/0.5Cu)



Series	Standard Profile						Limit Profile					
	Pre-heating		Heating		Peak Temperature (T3) °C	Cycle of Reflow	Pre-heating		Heating		Peak Temperature (T5) °C	Cycle of Reflow
	Temp. (T1) °C	Time (t1) sec.	Temp. (T2) °C	Time (t2) sec.			Temp. (T1) °C	Time (t1) sec.	Temp. (T4) °C	Time (t3) sec.		
PVM4	150 to 180	60 to 120	220	30 to 60	245±3	2	150 to 180	60 to 120	230	30 to 50	260 +5/-0	2

2. Soldering profile for Eutectic solder (63Sn/37Pb)

(Limit profile: refer to 1)



Series	Standard Profile					
	Pre-heating		Heating		Peak Temperature (T3) °C	Cycle of Reflow
	Temp. (T1) °C	Time (t1) sec.	Temp. (T2) °C	Time (t2) sec.		
PVM4	150	60 to 120	183	30	230	1

● Soldering Iron

Series	Standard Condition			
	Temperature of Soldering Iron Tip °C	Soldering Time sec.	Soldering Iron Power Output W	Cycle of Soldering Iron Time
PVM4	350±10	3 max.	30 max.	1

Continued on the following page. ☐

PVM4 Series Notice

☐ Continued from the preceding page.

■ Notice (Handling)

1. Use suitable screwdrivers that fit comfortably in the driver slot. We recommend the screwdriver below.
* Recommended screwdriver for manual adjustment
VESSEL MFG.: NO. 9000-2.6x30
(Murata P/N: KMDR120)
We can supply the screwdrivers above.
If you place an order, please specify the Murata P/N.
2. Do not apply more than 4.9N (Ref. 500gf) of twist and stress after mounting onto PCB to prevent contact intermittence. If excessive force is applied, the trimmer potentiometer may not function.

3. Please use within the effective rotational angle.
The potentiometer does not have a mechanical stop for over rotation. In cases out of effective rotational angle, the trimmer potentiometer may not function.
4. When using a lock paint to fix the slot position, please use adhesive resin without chlorine or sulfur (Three-bond "1401 series") and evaluate performance with your product. Lock paint may cause corrosion or electrical contact problems.

■ Notice (Other)

1. Please make sure that your product has been evaluated and confirmed against your specifications when our product is mounted to your product.
2. Murata cannot guarantee trimmer potentiometer integrity when used under conditions other than those specified in this document.

Trimmer Potentiometers



SMD Sealed Type Multi-turn PVG5 Series

■ Features

1. Sealed construction protects the interior from dust and liquid, which achieves stable performance.
2. Available with reflow soldering method
3. Available for ultrasonic cleaning after soldering.
4. Clutch mechanism prevents excessive wiper rotation.
5. Both top and side adjustment directions.
6. Much smaller volume (1/5-1/2) than leaded multi-turn potentiometer.
7. Complies with RoHS directive by new Cd free cermet resistive material. Pb free terminals with Sn plating.

■ Applications

1. Measuring instruments
2. OA equipment
3. Medical equipment
4. Power supply
5. Sensors
6. Base station for cellular phones



PVG5A



PVG5H

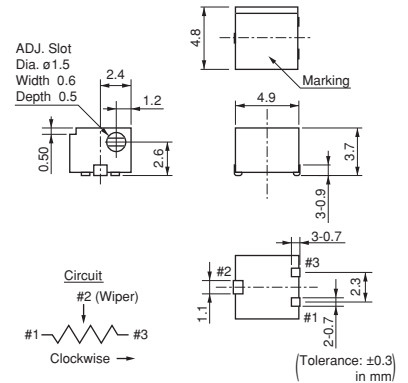

5

Top Adjustment

Part Number	Power Rating (W)	Number of Turns (Effective Rotation Angle)	Total Resistance Value	TCR (ppm/°C)
PVG5A100C03	0.25(70°C)	11	10ohm±10%	±150
PVG5A200C03	0.25(70°C)	11	20ohm±10%	±150
PVG5A500C03	0.25(70°C)	11	50ohm±10%	±150
PVG5A101C03	0.25(70°C)	11	100ohm±10%	±150
PVG5A201C03	0.25(70°C)	11	200ohm±10%	±150
PVG5A501C03	0.25(70°C)	11	500ohm±10%	±150
PVG5A102C03	0.25(70°C)	11	1k ohm±10%	±150
PVG5A202C03	0.25(70°C)	11	2k ohm±10%	±150
PVG5A502C03	0.25(70°C)	11	5k ohm±10%	±150
PVG5A103C03	0.25(70°C)	11	10k ohm±10%	±150
PVG5A203C03	0.25(70°C)	11	20k ohm±10%	±150
PVG5A503C03	0.25(70°C)	11	50k ohm±10%	±150
PVG5A104C03	0.25(70°C)	11	100k ohm±10%	±150
PVG5A204C03	0.25(70°C)	11	200k ohm±10%	±150
PVG5A504C03	0.25(70°C)	11	500k ohm±10%	±150
PVG5A105C03	0.25(70°C)	11	1M ohm±10%	±150
PVG5A205C03	0.25(70°C)	11	2M ohm±10%	±150

Operating Temperature Range: -55 to 125 °C
 Soldering Method: Reflow/Soldering Iron



Side Adjustment

Part Number	Power Rating (W)	Number of Turns (Effective Rotation Angle)	Total Resistance Value	TCR (ppm/°C)
PVG5H100C03	0.25(70°C)	11	10ohm±10%	±150
PVG5H200C03	0.25(70°C)	11	20ohm±10%	±150
PVG5H500C03	0.25(70°C)	11	50ohm±10%	±150
PVG5H101C03	0.25(70°C)	11	100ohm±10%	±150
PVG5H201C03	0.25(70°C)	11	200ohm±10%	±150
PVG5H501C03	0.25(70°C)	11	500ohm±10%	±150
PVG5H102C03	0.25(70°C)	11	1k ohm±10%	±150
PVG5H202C03	0.25(70°C)	11	2k ohm±10%	±150
PVG5H502C03	0.25(70°C)	11	5k ohm±10%	±150
PVG5H103C03	0.25(70°C)	11	10k ohm±10%	±150
PVG5H203C03	0.25(70°C)	11	20k ohm±10%	±150
PVG5H503C03	0.25(70°C)	11	50k ohm±10%	±150
PVG5H104C03	0.25(70°C)	11	100k ohm±10%	±150
PVG5H204C03	0.25(70°C)	11	200k ohm±10%	±150
PVG5H504C03	0.25(70°C)	11	500k ohm±10%	±150
PVG5H105C03	0.25(70°C)	11	1M ohm±10%	±150
PVG5H205C03	0.25(70°C)	11	2M ohm±10%	±150

Operating Temperature Range: -55 to 125 °C
 Soldering Method: Reflow/Soldering Iron

Construction



5

Standard Land Pattern



(Tolerance: ±0.1 in mm)



(Tolerance: ±0.1 in mm)

■ Characteristics

Temperature Cycle	Δ TR : $\pm 2\%$ Δ V.S.S.: $\pm 1\%$
Humidity	Δ TR : $\pm 2\%$ IR : 10M ohm min.
Vibration (20G)	Δ TR : $\pm 1\%$ Δ V.S.S.: $\pm 1\%$
Shock (100G)	Δ TR : $\pm 1\%$ Δ V.S.S.: $\pm 1\%$
Temperature Load Life	Δ TR : $\pm 3\%$ or 3 ohm max., whichever is greater Δ V.S.S.: $\pm 1\%$
Low Temperature Exposure	Δ TR : $\pm 1\%$ Δ V.S.S.: $\pm 1\%$
High Temperature Exposure	Δ TR : $\pm 2\%$ Δ V.S.S.: $\pm 1\%$
Rotational Life	Δ TR : $\pm 3\%$ or 3 ohm max., whichever is greater (100 cycles)

Δ TR : Total Resistance Change
 Δ V.S.S.: Voltage Setting Stability
 IR : Insulation Resistance

PVG5 Series Notice

■ Notice (Operating and Storage Conditions)

1. Store in temperatures of -10 to +40°C and relative humidity of 30-85%.
2. Do not store in or near corrosive gases.
3. Use within six months after delivery.
4. Open the package just before using.
5. Do not store under direct sunlight.
6. If you use the trimmer potentiometer in an environment other than listed at right, please consult with a Murata factory representative prior to using.

The trimmer potentiometer should not be used under the following environmental conditions:

- (1) Corrosive gaseous atmosphere
(Ex. Chlorine gas, Hydrogen sulfide gas, Ammonia gas, Sulfuric acid gas, Nitric oxide gas, etc.)
- (2) In liquid
(Ex. Oil, Medical liquid, Organic solvent, etc.)
- (3) Dusty/dirty atmosphere
- (4) Direct sunlight
- (5) Static voltage or electric/magnetic fields
- (6) Direct sea breeze
- (7) Other variations of the above

■ Notice (Rating)

1. When using with partial load (rheostat), minimize the power depending on the resistance value.
2. The maximum input voltage to a trimmer potentiometer should not exceed $(P \cdot R)^{1/2}$ or the maximum operating voltage, whichever is smaller.

■ Notice (Soldering and Mounting)

1. Soldering
 - (1) Soldering conditions
Refer to the temperature profile.
If the soldering conditions are not suitable, e.g., excessive time and/or excessive temperature, the trimmer capacitor may deviate from the specified characteristics.
 - (2) This product cannot be soldered using the flow soldering method. If you use the flow soldering method, the trimmer potentiometer may not function.
 - (3) The soldering iron should not come in contact with the case of the trimmer potentiometer. If such contact does occur, the trimmer potentiometer may be damaged.
 - (4) Insufficient amounts of solder can lead to insufficient soldering strength on PCB.
Excessive amounts of solder may cause bridging between the terminals.

2. Mounting
 - (1) Use our standard land dimension. Excessive land area causes displacement due to the effect of the surface tension of the solder. Insufficient land area leads to insufficient soldering strength of the chip.
 - (2) Do not apply excessive force, preferably 9.8N max. (Ref. 1kgf) when the trimmer potentiometer is mounted to the PCB.
 - (3) Do not warp and/or bend the PC board to protect trimmer potentiometer from breakage.
 - (4) In chip placers, the recommended size of the cylindrical pick-up nozzle should be outer dimension 4.0mm dia. and inner dimension 2.0mm dia.
3. Cleaning
Isopropyl alcohol and ethyl alcohol are applicable solvents for cleaning. If you use any other types of solvents, please consult with a Murata factory representative prior to using.

Continued on the following page. 

PVG5 Series Notice

Continued from the preceding page.

■ Soldering Profile

● Reflow Soldering Profile

1. Soldering profile for lead free solder (96.5Sn/3.0Ag/0.5Cu)



Series	Standard Profile						Limit Profile					
	Pre-heating		Heating		Peak Temperature (T3)	Cycle of Reflow	Pre-heating		Heating		Peak Temperature (T5)	Cycle of Reflow
	Temp. (T1)	Time (t1)	Temp. (T2)	Time (t2)			Temp. (T1)	Time (t1)	Temp. (T4)	Time (t3)		
°C	sec.	°C	sec.	°C	Time	°C	sec.	°C	sec.	°C	Time	
PVG5	150 to 180	60 to 120	220	30 to 60	245±3	2	150 to 180	60 to 120	230	30 to 50	260 +5/-0	2

2. Soldering profile for Eutectic solder (63Sn/37Pb)

(Limit profile: refer to 1)



Series	Standard Profile					
	Pre-heating		Heating		Peak Temperature (T3)	Cycle of Reflow
	Temp. (T1)	Time (t1)	Temp. (T2)	Time (t2)		
°C	sec.	°C	sec.	°C	Time	
PVG5	150	60 to 120	183	30	230	1

5

● Soldering Iron

Series	Standard Condition			
	Temperature of Soldering Iron Tip	Soldering Time	Soldering Iron Power Output	Cycle of Soldering Iron
	°C	sec.	W	Time
PVG5	350±10	3 max.	30 max.	1

■ Notice (Handling)

- Use suitable screwdrivers that fit comfortably in the driver slot. We recommend the screwdrivers below.
 * Recommended screwdrivers for manual adjustment
 <PVG5 series>
 VESSEL MFG.: NO.9000-1.3x30
 (Murata P/N: KMDR130)
 We can supply the screwdrivers above.
 If you place an order, please specify the Murata P/N.

- When adjusting with a screwdriver, do not apply excessive force, preferable 4.9N max. (Ref 500gf).
- When using a lock paint to fix the slot position, please use adhesive resin without chlorine or sulfur (Three-bond "1401 series") and evaluate performance with your product. Lock paint may cause corrosion or electrical problems.

■ Notice (Other)

- Please make sure that your product has been evaluated and confirmed against your specifications when our product is mounted to your product.
- Murata cannot guarantee trimmer potentiometer integrity when used under conditions other than those specified in this document.

Trimmer Potentiometers



Lead Sealed Type Single-turn PV32 Series

■ Features

1. Round body shape enables smaller area mount than same 6mm square potentiometer.
2. Sealed construction protects the interior from dust and liquid, which achieves stable performance.
3. Available for ultrasonic cleaning after soldering.
4. Flammability: UL94V-0
5. PV32 series complies with RoHS directive.

■ Applications

- | | |
|-------------------------|-----------------|
| 1. HDTVs | 5. Printers |
| 2. Professional cameras | 6. Sensors |
| 3. CATV | 7. Power supply |
| 4. FAX | |



PV32H



PV32N



Top Adjustment

Part Number	Power Rating (W)	Number of Turns (Effective Rotation Angle)	Mechanical Rotation Angle	Total Resistance Value	TCR (ppm/°C)
PV32H100A01	0.5(70°C)	1(230°±5°)	270+/-5 deg.	10ohm±20%	±100
PV32H200A01	0.5(70°C)	1(230°±5°)	270+/-5 deg.	20ohm±20%	±100
PV32H500A01	0.5(70°C)	1(230°±5°)	270+/-5 deg.	50ohm±20%	±100
PV32H101A01	0.5(70°C)	1(230°±5°)	270+/-5 deg.	100ohm±20%	±100
PV32H201A01	0.5(70°C)	1(230°±5°)	270+/-5 deg.	200ohm±20%	±100
PV32H501A01	0.5(70°C)	1(230°±5°)	270+/-5 deg.	500ohm±20%	±100
PV32H102A01	0.5(70°C)	1(230°±5°)	270+/-5 deg.	1k ohm±20%	±100
PV32H202A01	0.5(70°C)	1(230°±5°)	270+/-5 deg.	2k ohm±20%	±100
PV32H502A01	0.5(70°C)	1(230°±5°)	270+/-5 deg.	5k ohm±20%	±100
PV32H103A01	0.5(70°C)	1(230°±5°)	270+/-5 deg.	10k ohm±20%	±100
PV32H203A01	0.5(70°C)	1(230°±5°)	270+/-5 deg.	20k ohm±20%	±100
PV32H503A01	0.5(70°C)	1(230°±5°)	270+/-5 deg.	50k ohm±20%	±100
PV32H104A01	0.5(70°C)	1(230°±5°)	270+/-5 deg.	100k ohm±20%	±100
PV32H204A01	0.5(70°C)	1(230°±5°)	270+/-5 deg.	200k ohm±20%	±100
PV32H504A01	0.5(70°C)	1(230°±5°)	270+/-5 deg.	500k ohm±20%	±100
PV32H105A01	0.5(70°C)	1(230°±5°)	270+/-5 deg.	1M ohm±20%	±100
PV32H205A01	0.5(70°C)	1(230°±5°)	270+/-5 deg.	2M ohm±20%	±100
PV32H505A01	0.5(70°C)	1(230°±5°)	270+/-5 deg.	5M ohm±20%	±100

Operating Temperature Range: -55 to 125 °C
 Soldering Method: Flow/Soldering Iron

Side Adjustment

Part Number	Power Rating (W)	Number of Turns (Effective Rotation Angle)	Mechanical Rotation Angle	Total Resistance Value	TCR (ppm/°C)
PV32N100A01	0.5(70°C)	1(230°±5°)	270+/-5 deg.	10ohm±20%	±100
PV32N200A01	0.5(70°C)	1(230°±5°)	270+/-5 deg.	20ohm±20%	±100
PV32N500A01	0.5(70°C)	1(230°±5°)	270+/-5 deg.	50ohm±20%	±100
PV32N101A01	0.5(70°C)	1(230°±5°)	270+/-5 deg.	100ohm±20%	±100
PV32N201A01	0.5(70°C)	1(230°±5°)	270+/-5 deg.	200ohm±20%	±100
PV32N501A01	0.5(70°C)	1(230°±5°)	270+/-5 deg.	500ohm±20%	±100
PV32N102A01	0.5(70°C)	1(230°±5°)	270+/-5 deg.	1k ohm±20%	±100
PV32N202A01	0.5(70°C)	1(230°±5°)	270+/-5 deg.	2k ohm±20%	±100
PV32N502A01	0.5(70°C)	1(230°±5°)	270+/-5 deg.	5k ohm±20%	±100
PV32N103A01	0.5(70°C)	1(230°±5°)	270+/-5 deg.	10k ohm±20%	±100
PV32N203A01	0.5(70°C)	1(230°±5°)	270+/-5 deg.	20k ohm±20%	±100
PV32N503A01	0.5(70°C)	1(230°±5°)	270+/-5 deg.	50k ohm±20%	±100
PV32N104A01	0.5(70°C)	1(230°±5°)	270+/-5 deg.	100k ohm±20%	±100
PV32N204A01	0.5(70°C)	1(230°±5°)	270+/-5 deg.	200k ohm±20%	±100
PV32N504A01	0.5(70°C)	1(230°±5°)	270+/-5 deg.	500k ohm±20%	±100
PV32N105A01	0.5(70°C)	1(230°±5°)	270+/-5 deg.	1M ohm±20%	±100
PV32N205A01	0.5(70°C)	1(230°±5°)	270+/-5 deg.	2M ohm±20%	±100
PV32N505A01	0.5(70°C)	1(230°±5°)	270+/-5 deg.	5M ohm±20%	±100

Operating Temperature Range: -55 to 125 °C

Soldering Method: Flow/Soldering Iron

Construction



6

Standard Mounting Holes

PV32H



(Tolerance: ±0.1 in mm)

PV32N



(Tolerance: ±0.1 in mm)

■ Characteristics

Temperature Cycle	ΔTR : $\pm 2\%$ $\Delta V.S.S.$: $\pm 1\%$
Humidity	ΔTR : $\pm 2\%$ IR : 100M ohm min.
Vibration (20G)	ΔTR : $\pm 1\%$ $\Delta V.S.S.$: $\pm 1\%$
Shock (100G)	ΔTR : $\pm 1\%$ $\Delta V.S.S.$: $\pm 1\%$
Temperature Load Life	ΔTR : $\pm 2\%$ $\Delta V.S.S.$: $\pm 2\%$
Low Temperature Exposure	ΔTR : $\pm 2\%$ $\Delta V.S.S.$: $\pm 1\%$
High Temperature Exposure	ΔTR : $\pm 2\%$ $\Delta V.S.S.$: $\pm 1\%$
Rotational Life	ΔTR : $\pm 4\%$ (200 cycles)

ΔTR : Total Resistance Change
 $\Delta V.S.S.$: Voltage Setting Stability
 IR : Insulation Resistance

PV32 Series Notice

■ Notice (Operating and Storage Conditions)

1. Store in temperatures of -10 to +40°C and relative humidity of 30-85%.
2. Do not store in or near corrosive gases.
3. Use within six months after delivery.
4. Open the package just before using.
5. Do not store under direct sunlight.
6. If you use the trimmer potentiometer in an environment other than listed at right, please consult with a Murata factory representative prior to using.

The trimmer potentiometer should not be used under the following environmental conditions:

- (1) Corrosive gaseous atmosphere
(Ex. Chlorine gas, Hydrogen sulfide gas, Ammonia gas, Sulfuric acid gas, Nitric oxide gas, etc.)
- (2) In liquid
(Ex. Oil, Medical liquid, Organic solvent, etc.)
- (3) Dusty/dirty atmosphere
- (4) Direct sunlight
- (5) Static voltage or electric/magnetic fields
- (6) Direct sea breeze
- (7) Other variations of the above

■ Notice (Rating)

1. When using with partial load (rheostat), minimize the power depending on the resistance value.
2. The maximum input voltage to a trimmer potentiometer should not exceed $(P \cdot R)^{1/2}$ or the maximum operating voltage, whichever is smaller.

■ Notice (Soldering and Mounting)

1. Soldering

(1) Soldering conditions

Refer to the temperature profile.

If the soldering conditions are not suitable, e.g., excessive time and/or excessive temperature, the trimmer potentiometer may deviate from the specified characteristics.

(2) To minimize mechanical stress when adjusting, the trimmer potentiometer should be mounted onto the PCB without a gap.

(3) The soldering iron should not come in contact with the case of the trimmer potentiometer. If such contact does occur, the trimmer potentiometer may be damaged.

2. Mounting

(1) Use the PCB hole to meet the pin of the trimmer potentiometer. If the trimmer potentiometer is installed into an insufficient PCB hole, the trimmer potentiometer may be damaged by mechanical stress.

(2) Do not apply excessive force, preferably 9.8N max. (Ref. 1kgf) when the trimmer potentiometer is mounted to the PCB.

3. Cleaning

Isopropyl alcohol and ethyl alcohol are applicable solvents for cleaning. If you use any other types of solvents, please consult with a Murata factory representative prior to using.

Continued on the following page. 

PV32 Series Notice

☐ Continued from the preceding page.

■ Soldering Profile

● Flow Soldering Profile

Soldering profile for lead free solder (96.5Sn/3.0Ag/0.5Cu), Eutectic solder (63Sn/37Pb)



Series	Standard Profile					Limit Profile				
	Pre-heating		Heating		Cycle of Flow	Pre-heating		Heating		Cycle of Flow
	Temp. (T1)	Time (t1)	Temp. (T2)	Time (t2)		Temp. (T1)	Time (t1)	Temp. (T3)	Time (t2)	
	°C	sec.	°C	sec.	Time	°C	sec.	°C	sec.	Time
PV32	150	60 to 120	250	5 max.	1	150	60 to 120	260	3 max.	1

● Soldering Iron

Series	Standard Condition			
	Temperature of Soldering Iron Tip	Soldering Time	Soldering Iron Power Output	Cycle of Soldering Iron
	°C	sec.	W	Time
PV32	350±10	3 max.	30 max.	1

■ Notice (Handling)

- Use suitable screwdrivers that fit comfortably in the driver slot. We recommend the screwdrivers below.
 * Recommended screwdriver for manual adjustment
 <PV32 series>
 ENGINEER INC.: DA-40
 (Murata P/N: KMDR180)
 We can supply the screwdrivers above.
 If you place an order, please specify the Murata P/N.
- When adjusting with an adjustment tool, the applied force to the adjustment screw should not exceed 4.9N (Ref. 500gf). If excessive force is applied, the trimmer potentiometer may not function due to damage.
- The rotational torque at the position of the adjustment range should not exceed the stop strength.
- When using a lock paint to fix the slot position, please use adhesive resin without chlorine or sulfur (Three-bond "1401 series") and evaluate performance with your product. Lock paint may cause corrosion or electrical contact problems.

■ Notice (Other)

- Please make sure that your product has been evaluated and confirmed against your specifications when our product is mounted to your product.
- Murata cannot guarantee trimmer potentiometer integrity when used under conditions other than those specified in this document.

Trimmer Potentiometers



Lead Sealed Type Multi-turn PV12/PV37/PV36 Series

PV12 Series

■ Features

1. The unique inner gear system recognizes the position of the center of the shaft of the potentiometer.
2. Sealed construction protects the interior from dust and liquid, which achieves stable performance.
3. Available for ultrasonic cleaning after soldering.
4. Clutch mechanism prevents excessive wiper rotation.
5. PV12 series complies with RoHS directive.

■ Applications

- | | |
|-------------------------|-----------------------------|
| 1. HDTVs | 5. Printers |
| 2. Professional cameras | 6. Sensors |
| 3. CATV | 7. Switching power supplies |
| 4. FAX | |



Top Adjustment

Part Number	Power Rating (W)	Number of Turns (Effective Rotation Angle)	Total Resistance Value	TCR (ppm/°C)
PV12P100A01	0.5(70°C)	4	10ohm±10%	±100
PV12P200A01	0.5(70°C)	4	20ohm±10%	±100
PV12P500A01	0.5(70°C)	4	50ohm±10%	±100
PV12P101A01	0.5(70°C)	4	100ohm±10%	±100
PV12P201A01	0.5(70°C)	4	200ohm±10%	±100
PV12P501A01	0.5(70°C)	4	500ohm±10%	±100
PV12P102A01	0.5(70°C)	4	1k ohm±10%	±100
PV12P202A01	0.5(70°C)	4	2k ohm±10%	±100
PV12P502A01	0.5(70°C)	4	5k ohm±10%	±100
PV12P103A01	0.5(70°C)	4	10k ohm±10%	±100
PV12P203A01	0.5(70°C)	4	20k ohm±10%	±100
PV12P503A01	0.5(70°C)	4	50k ohm±10%	±100
PV12P104A01	0.5(70°C)	4	100k ohm±10%	±100
PV12P204A01	0.5(70°C)	4	200k ohm±10%	±100
PV12P504A01	0.5(70°C)	4	500k ohm±10%	±100
PV12P105A01	0.5(70°C)	4	1M ohm±10%	±100
PV12P205A01	0.5(70°C)	4	2M ohm±10%	±100

Operating Temperature Range: -55 to 125 °C
 Soldering Method: Flow/Soldering Iron

7

Side Adjustment

Part Number	Power Rating (W)	Number of Turns (Effective Rotation Angle)	Total Resistance Value	TCR (ppm/°C)
PV12T100A01	0.5(70°C)	4	10ohm±10%	±100
PV12T200A01	0.5(70°C)	4	20ohm±10%	±100
PV12T500A01	0.5(70°C)	4	50ohm±10%	±100
PV12T101A01	0.5(70°C)	4	100ohm±10%	±100
PV12T201A01	0.5(70°C)	4	200ohm±10%	±100
PV12T501A01	0.5(70°C)	4	500ohm±10%	±100
PV12T102A01	0.5(70°C)	4	1k ohm±10%	±100
PV12T202A01	0.5(70°C)	4	2k ohm±10%	±100
PV12T502A01	0.5(70°C)	4	5k ohm±10%	±100
PV12T103A01	0.5(70°C)	4	10k ohm±10%	±100
PV12T203A01	0.5(70°C)	4	20k ohm±10%	±100
PV12T503A01	0.5(70°C)	4	50k ohm±10%	±100
PV12T104A01	0.5(70°C)	4	100k ohm±10%	±100
PV12T204A01	0.5(70°C)	4	200k ohm±10%	±100
PV12T504A01	0.5(70°C)	4	500k ohm±10%	±100
PV12T105A01	0.5(70°C)	4	1M ohm±10%	±100
PV12T205A01	0.5(70°C)	4	2M ohm±10%	±100

Operating Temperature Range: -55 to 125 °C
 Soldering Method: Flow/Soldering Iron

Construction



Standard Mounting Holes

PV12P



(Tolerance: ±0.1 in mm)

PV12T



(Tolerance: ±0.1 in mm)

■ Characteristics

Temperature Cycle	ΔTR : $\pm 2\%$ $\Delta V.S.S.$: $\pm 1\%$
Humidity	ΔTR : $\pm 2\%$ IR : 100M ohm min.
Vibration (20G)	ΔTR : $\pm 1\%$ $\Delta V.S.S.$: $\pm 1\%$
Shock (100G)	ΔTR : $\pm 1\%$ $\Delta V.S.S.$: $\pm 1\%$
Temperature Load Life	ΔTR : $\pm 3\%$ $\Delta V.S.S.$: $\pm 2\%$
Low Temperature Exposure	ΔTR : $\pm 3\%$ $\Delta V.S.S.$: $\pm 1.5\%$
High Temperature Exposure	ΔTR : $\pm 3\%$ $\Delta V.S.S.$: $\pm 1.5\%$
Rotational Life	ΔTR : $\pm 3\%$ (200 cycles)

ΔTR : Total Resistance Change
 $\Delta V.S.S.$: Voltage Setting Stability
 IR : Insulation Resistance

PV37 Series

■ Features

1. Smaller volume (about one-third) than 25-turn potentiometer
2. Sealed construction protects the interior from dust and liquid, which achieves stable performance.
3. Available for ultrasonic cleaning after soldering.
4. Clutch mechanism prevents excessive wiper rotation.
5. Both top and side adjustment directions.
6. Complies with RoHS directive by new Cd free cermet resistive material. Pb free terminals with Sn plating.

■ Applications

1. Measuring instruments
2. OA equipment
3. Medical equipment
4. Power supply
5. Base station for cellular phones

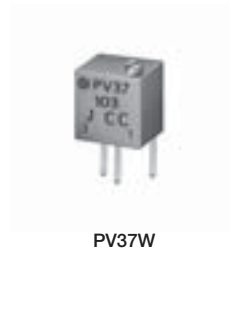

Top Adjustment

Part Number	Power Rating (W)	Number of Turns (Effective Rotation Angle)	Total Resistance Value	TCR (ppm/°C)
PV37W100C01	0.25(85°C)	12	10ohm±10%	±150
PV37W200C01	0.25(85°C)	12	20ohm±10%	±150
PV37W500C01	0.25(85°C)	12	50ohm±10%	±150
PV37W101C01	0.25(85°C)	12	100ohm±10%	±150
PV37W201C01	0.25(85°C)	12	200ohm±10%	±150
PV37W501C01	0.25(85°C)	12	500ohm±10%	±150
PV37W102C01	0.25(85°C)	12	1k ohm±10%	±150
PV37W202C01	0.25(85°C)	12	2k ohm±10%	±150
PV37W502C01	0.25(85°C)	12	5k ohm±10%	±150
PV37W103C01	0.25(85°C)	12	10k ohm±10%	±150
PV37W203C01	0.25(85°C)	12	20k ohm±10%	±150
PV37W503C01	0.25(85°C)	12	50k ohm±10%	±150
PV37W104C01	0.25(85°C)	12	100k ohm±10%	±150
PV37W204C01	0.25(85°C)	12	200k ohm±10%	±150
PV37W504C01	0.25(85°C)	12	500k ohm±10%	±150
PV37W105C01	0.25(85°C)	12	1M ohm±10%	±150
PV37W205C01	0.25(85°C)	12	2M ohm±10%	±150

Operating Temperature Range: -55 to 125 °C
 Soldering Method: Flow/Soldering Iron

7

Side Adjustment

Part Number	Power Rating (W)	Number of Turns (Effective Rotation Angle)	Total Resistance Value	TCR (ppm/°C)
PV37X100C01	0.25(85°C)	12	10ohm±10%	±150
PV37X200C01	0.25(85°C)	12	20ohm±10%	±150
PV37X500C01	0.25(85°C)	12	50ohm±10%	±150
PV37X101C01	0.25(85°C)	12	100ohm±10%	±150
PV37X201C01	0.25(85°C)	12	200ohm±10%	±150
PV37X501C01	0.25(85°C)	12	500ohm±10%	±150
PV37X102C01	0.25(85°C)	12	1k ohm±10%	±150
PV37X202C01	0.25(85°C)	12	2k ohm±10%	±150
PV37X502C01	0.25(85°C)	12	5k ohm±10%	±150
PV37X103C01	0.25(85°C)	12	10k ohm±10%	±150
PV37X203C01	0.25(85°C)	12	20k ohm±10%	±150
PV37X503C01	0.25(85°C)	12	50k ohm±10%	±150
PV37X104C01	0.25(85°C)	12	100k ohm±10%	±150
PV37X204C01	0.25(85°C)	12	200k ohm±10%	±150
PV37X504C01	0.25(85°C)	12	500k ohm±10%	±150
PV37X105C01	0.25(85°C)	12	1M ohm±10%	±150
PV37X205C01	0.25(85°C)	12	2M ohm±10%	±150

Operating Temperature Range: -55 to 125 °C
 Soldering Method: Flow/Soldering Iron

Construction



Standard Mounting Holes

PV37W/PV37X

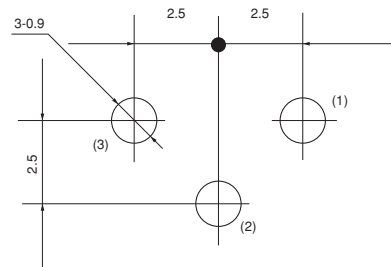

(Tolerance: ±0.1 in mm)

7

Characteristics

Temperature Cycle	ΔTR : ±1% $\Delta V.S.S.$: ±1%
Humidity	ΔTR : ±2% IR : 100M ohm min.
Vibration (20G)	ΔTR : ±1% $\Delta V.S.S.$: ±1%
Shock (100G)	ΔTR : ±1% $\Delta V.S.S.$: ±1%
Temperature Load Life	ΔTR : ±2% $\Delta V.S.S.$: ±1%
Low Temperature Exposure	ΔTR : ±1% $\Delta V.S.S.$: ±1%
High Temperature Exposure	ΔTR : ±2% $\Delta V.S.S.$: ±1%
Rotational Life	ΔTR : $R \leq 100$ ohm ... ±3% $R > 100$ ohm ... ±2% (200 cycles)

ΔTR : Total Resistance Change
 $\Delta V.S.S.$: Voltage Setting Stability
 IR : Insulation Resistance
 R : Standard Total Resistance

PV36 Series

■ Features

1. High resolution 25-turns potentiometer enables precision adjustment easily.
2. Sealed construction protects the interior from dust and liquid, which achieves stable performance.
3. Available for ultrasonic cleaning after soldering.
4. Clutch mechanism prevents excessive wiper rotation.
5. Both top and side adjustment directions.
6. Complies with RoHS directive by new Cd free cermet resistive material. Pb free terminals with Sn plating.

■ Applications

1. Measuring instruments
2. OA equipment
3. Medical equipment
4. Power supply
5. Base station for cellular phones



Top Adjustment

Part Number	Power Rating (W)	Number of Turns (Effective Rotation Angle)	Total Resistance Value	TCR (ppm/°C)
PV36W100C01	0.5(70°C)	25	10ohm±10%	±150
PV36W200C01	0.5(70°C)	25	20ohm±10%	±150
PV36W500C01	0.5(70°C)	25	50ohm±10%	±150
PV36W101C01	0.5(70°C)	25	100ohm±10%	±150
PV36W201C01	0.5(70°C)	25	200ohm±10%	±100
PV36W501C01	0.5(70°C)	25	500ohm±10%	±100
PV36W102C01	0.5(70°C)	25	1k ohm±10%	±100
PV36W202C01	0.5(70°C)	25	2k ohm±10%	±100
PV36W502C01	0.5(70°C)	25	5k ohm±10%	±100
PV36W103C01	0.5(70°C)	25	10k ohm±10%	±100
PV36W203C01	0.5(70°C)	25	20k ohm±10%	±100
PV36W503C01	0.5(70°C)	25	50k ohm±10%	±100
PV36W104C01	0.5(70°C)	25	100k ohm±10%	±100
PV36W204C01	0.5(70°C)	25	200k ohm±10%	±100
PV36W504C01	0.5(70°C)	25	500k ohm±10%	±100
PV36W105C01	0.5(70°C)	25	1M ohm±10%	±100
PV36W205C01	0.5(70°C)	25	2M ohm±10%	±100

Operating Temperature Range: -55 to 125 °C
 Soldering Method: Flow/Soldering Iron

7

Side Adjustment

Part Number	Power Rating (W)	Number of Turns (Effective Rotation Angle)	Total Resistance Value	TCR (ppm/°C)
PV36X100C01	0.5(70°C)	25	10ohm±10%	±150
PV36X200C01	0.5(70°C)	25	20ohm±10%	±150
PV36X500C01	0.5(70°C)	25	50ohm±10%	±150
PV36X101C01	0.5(70°C)	25	100ohm±10%	±150
PV36X201C01	0.5(70°C)	25	200ohm±10%	±100
PV36X501C01	0.5(70°C)	25	500ohm±10%	±100
PV36X102C01	0.5(70°C)	25	1k ohm±10%	±100
PV36X202C01	0.5(70°C)	25	2k ohm±10%	±100
PV36X502C01	0.5(70°C)	25	5k ohm±10%	±100
PV36X103C01	0.5(70°C)	25	10k ohm±10%	±100
PV36X203C01	0.5(70°C)	25	20k ohm±10%	±100
PV36X503C01	0.5(70°C)	25	50k ohm±10%	±100
PV36X104C01	0.5(70°C)	25	100k ohm±10%	±100
PV36X204C01	0.5(70°C)	25	200k ohm±10%	±100
PV36X504C01	0.5(70°C)	25	500k ohm±10%	±100
PV36X105C01	0.5(70°C)	25	1M ohm±10%	±100
PV36X205C01	0.5(70°C)	25	2M ohm±10%	±100

Operating Temperature Range: -55 to 125 °C
 Soldering Method: Flow/Soldering Iron

Construction



Standard Mounting Holes

PV36W/X

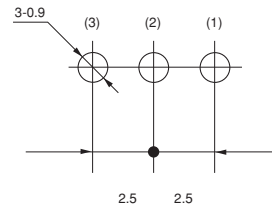

(Tolerance: ±0.1 in mm)

7

Characteristics

Temperature Cycle	Δ TR : ±2% Δ V.S.S.: ±1%
Humidity	Δ TR : ±2% IR : 100M ohm min.
Vibration (20G)	Δ TR : ±1% Δ V.S.S.: ±1%
Shock (100G)	Δ TR : ±1% Δ V.S.S.: ±1%
Temperature Load Life	Δ TR : ±3% Δ V.S.S.: ±1%
Low Temperature Exposure	Δ TR : ±2% Δ V.S.S.: ±1%
High Temperature Exposure	Δ TR : ±3% Δ V.S.S.: ±1%
Rotational Life	Δ TR : R≤1k ohm, R≥500k ohm ... ±5% 1k ohm<R<500k ohm ... ±3% (200 cycles)

Δ TR : Total Resistance Change
 Δ V.S.S.: Voltage Setting Stability
 IR : Insulation Resistance
 R : Standard Total Resistance

PV12/PV37/PV36 Series Notice

■ Notice (Operating and Storage Conditions)

1. Store in temperatures of -10 to +40°C and relative humidity of 30-85%.
2. Do not store in or near corrosive gases.
3. Use within six months after delivery.
4. Open the package just before using.
5. Do not store under direct sunlight.
6. If you use the trimmer potentiometer in an environment other than listed at right, please consult with a Murata factory representative prior to using.

The trimmer potentiometer should not be used under the following environmental conditions:

- (1) Corrosive gaseous atmosphere
(Ex. Chlorine gas, Hydrogen sulfide gas, Ammonia gas, Sulfuric acid gas, Nitric oxide gas, etc.)
- (2) In liquid
(Ex. Oil, Medical liquid, Organic solvent, etc.)
- (3) Dusty/dirty atmosphere
- (4) Direct sunlight
- (5) Static voltage or electric/magnetic fields
- (6) Direct sea breeze
- (7) Other variations of the above

■ Notice (Rating)

1. When using with partial load (rheostat), minimize the power depending on the resistance value.
2. The maximum input voltage to a trimmer potentiometer should not exceed $(P \cdot R)^{1/2}$ or the maximum operating voltage, whichever is smaller.

■ Notice (Soldering and Mounting)

1. Soldering

(1) Soldering conditions

Refer to the temperature profile.

If the soldering conditions are not suitable, e.g., excessive time and/or excessive temperature, the trimmer potentiometer may deviate from the specified characteristics.

(2) To minimize mechanical stress when adjusting, the trimmer potentiometer should be mounted onto the PCB without a gap.

(3) The soldering iron should not come in contact with the case of the trimmer potentiometer. If such contact does occur, the trimmer potentiometer may be damaged.

2. Mounting

(1) Use the PCB hole to meet the pin of the trimmer potentiometer. If the trimmer potentiometer is installed into an insufficient PCB hole, the trimmer potentiometer may be damaged by mechanical stress.

(2) Do not apply excessive force, preferably 9.8N max. (Ref. 1kgf) when the trimmer potentiometer is mounted to the PCB.

3. Cleaning

Isopropyl alcohol and ethyl alcohol are applicable solvents for cleaning. If you use any other types of solvents, please consult with a Murata factory representative prior to using.

Continued on the following page. 

PV12/PV37/PV36 Series Notice

☐ Continued from the preceding page.

■ Soldering Profile

● Flow Soldering Profile

Soldering profile for lead free solder (96.5Sn/3.0Ag/0.5Cu), Eutectic solder (63Sn/37Pb)



Series	Standard Profile					Limit Profile				
	Pre-heating		Heating		Cycle of Flow	Pre-heating		Heating		Cycle of Flow
	Temp. (T1)	Time (t1)	Temp. (T2)	Time (t2)		Temp. (T1)	Time (t1)	Temp. (T3)	Time (t2)	
	°C	sec.	°C	sec.	Time	°C	sec.	°C	sec.	Time
PV12 PV37 PV36	150	60 to 120	250	5 max.	1	150	60 to 120	260	3 max.	1

● Soldering Iron

Series	Standard Condition			
	Temperature of Soldering Iron Tip	Soldering Time	Soldering Iron Power Output	Cycle of Soldering Iron
	°C	sec.	W	Time
PV12 PV37 PV36	350±10	3 max.	30 max.	1

■ Notice (Handling)

- Use suitable screwdrivers that fit comfortably in the driver slot. We recommend the screwdrivers below.
 * Recommended screwdriver for manual adjustment
 ENGINEER INC.: DA-40
 (Murata P/N: KMDR180)

We can supply the screwdrivers above.

If you place an order, please specify the Murata P/N.

- When adjusting with an adjustment tool, the applied force to the adjustment screw should not exceed 4.9N (Ref. 500gf). If excessive force is applied, the trimmer potentiometer may not function due to damage.

- When using a lock paint to fix the slot position, please use adhesive resin without chlorine or sulfur (Three-bond "1401 series") and evaluate performance with your product. Lock paint may cause corrosion or electrical contact problems.

■ Notice (Other)

- Please make sure that your product has been evaluated and confirmed against your specifications when our product is mounted to your product.
- Murata cannot guarantee trimmer potentiometer integrity when used under conditions other than those specified in this document.

7

SMD Open Type (PVZ2/A2/Z3)/SMD Sealed Type (PVM4A_C01 Series) Specifications and Test Methods

The tests and measurements should be conducted under the conditions of 15 to 35°C of temperature, 25 to 75% of relative humidity and 86 to 106 kpa of atmospheric pressure unless otherwise specified. If questionable results occur that have been measured in accordance with the above-mentioned conditions, the tests and measurements should be conducted under the conditions of 25±2°C of temperature, 45 to 55% of relative humidity and 86 to 106 kpa of atmospheric pressure.

No.	Item	Test Methods																																
1	Residual Resistance	Position the contact arm at the extreme counterclockwise limit of mechanical travel and measure the resistance between the contact arm and the corresponding end terminal. Then, position the contact arm at the extreme clockwise limit of mechanical travel and measure the resistance between the contact arm and the corresponding end terminal. During this test, take suitable precautions to ensure that the rated current of the resistance element is not exceeded.																																
2	Contact Resistance	<p>Contact resistance variation should be measured with the measuring circuit shown below, or its equivalent. The operating wiper should be rotated in both directions through 90% of the actual effective-electrical travel for a total of 6 cycles.</p> <p>The rate of rotation of the operating wiper should be such that the wiper completes 1 count in determining whether or not a contact resistance variation is observed at least twice in the same location. The test current should follow the value given in Table 2 unless otherwise limited by the power rating.</p> <p>• PVZ/PVA2</p> <table border="1" style="width: 100%; border-collapse: collapse; margin-bottom: 10px;"> <thead> <tr style="background-color: #f2f2f2;"> <th style="width: 60%;">Standard Total Resistance R (ohm)</th> <th style="width: 40%;">Test Current</th> </tr> </thead> <tbody> <tr> <td>100≤R<10k</td> <td>20mA max.</td> </tr> <tr> <td>10k≤R<100k</td> <td>1mA max.</td> </tr> <tr> <td>100k≤R</td> <td>100μA max.</td> </tr> </tbody> </table> <p>• PVM4A□□□C01</p> <table border="1" style="width: 100%; border-collapse: collapse; margin-bottom: 10px;"> <thead> <tr style="background-color: #f2f2f2;"> <th style="width: 25%;">Standard Total Resistance R (ohm)</th> <th style="width: 12.5%;">Test Current</th> <th style="width: 25%;">Standard Total Resistance R (ohm)</th> <th style="width: 12.5%;">Test Current</th> </tr> </thead> <tbody> <tr> <td>R≤100</td> <td>20mA</td> <td>50k≤R<200k</td> <td>200μA</td> </tr> <tr> <td>100<R<500</td> <td>10mA</td> <td>200k≤R<1M</td> <td>100μA</td> </tr> <tr> <td>500≤R<1k</td> <td>4mA</td> <td>1M≤R<2M</td> <td>50μA</td> </tr> <tr> <td>1k≤R<2k</td> <td>2mA</td> <td>2M≤R</td> <td>30μA</td> </tr> <tr> <td>2k≤R<50k</td> <td>1mA</td> <td></td> <td></td> </tr> </tbody> </table> <p style="text-align: center;">Table 2: Test current for CRV</p> <div style="display: flex; align-items: center; justify-content: center;">  </div> <p style="text-align: center;">Figure 1: CRV measuring circuit</p>	Standard Total Resistance R (ohm)	Test Current	100≤R<10k	20mA max.	10k≤R<100k	1mA max.	100k≤R	100μA max.	Standard Total Resistance R (ohm)	Test Current	Standard Total Resistance R (ohm)	Test Current	R≤100	20mA	50k≤R<200k	200μA	100<R<500	10mA	200k≤R<1M	100μA	500≤R<1k	4mA	1M≤R<2M	50μA	1k≤R<2k	2mA	2M≤R	30μA	2k≤R<50k	1mA		
Standard Total Resistance R (ohm)	Test Current																																	
100≤R<10k	20mA max.																																	
10k≤R<100k	1mA max.																																	
100k≤R	100μA max.																																	
Standard Total Resistance R (ohm)	Test Current	Standard Total Resistance R (ohm)	Test Current																															
R≤100	20mA	50k≤R<200k	200μA																															
100<R<500	10mA	200k≤R<1M	100μA																															
500≤R<1k	4mA	1M≤R<2M	50μA																															
1k≤R<2k	2mA	2M≤R	30μA																															
2k≤R<50k	1mA																																	
3	Humidity Exposure	The wiper contact point should be preset at about 50% position of effective rotational angle. After that, the potentiometer should be placed in a chamber at 40±2°C and 90 - 95% without loading for 500±12 hours. The resistance value should be measured after keeping the potentiometer in a room for 5±1/6 hours.																																
4	High Temperature Exposure	The wiper contact point should be preset at about 50% position of effective rotational angle. After that, the potentiometer should be placed in a chamber at 70±2°C without loading for 500±12 hours. The resistance value should be measured after keeping the potentiometer in a room for 1.5±1/6 hours.																																
5	Humidity Load Life	The wiper contact point should be preset at about 50% position of effective rotational angle. After that, the potentiometer should be placed in a chamber at 40±2°C and 90 - 95% with loading the 1/2 rated voltage between #1 and #2 terminals, intermittently 1.5 hours ON and 0.5 hours OFF for 1000±12 hours. The resistance value should be measured after keeping the potentiometer in a room for 5±1/6 hours.																																
6	Load Life	The wiper contact point should be preset at about 50% position of effective rotational angle. After that, the potentiometer should be placed in a chamber at 70±2°C (50±2°C for PVZ) with loading the 1/2 rated voltage between #1 and #2 terminals, intermittently 1.5 hours ON and 0.5 hours OFF for 1000±12 hours. The resistance value should be measured after keeping the potentiometer in a room for 1 to 2 hours.																																
7	Temperature Cycle	<p>The wiper contact point should be preset at about 50% position of effective rotational angle. After that, the potentiometer should be subjected to Table 3, Table 4 temperature for 5 cycles. The resistance value should be measured after keeping the potentiometer in a room for 1 to 2 hours.</p> <table border="1" style="width: 50%; border-collapse: collapse; margin-bottom: 10px;"> <thead> <tr style="background-color: #f2f2f2;"> <th style="width: 10%;">Sequence</th> <th style="width: 10%;">1</th> <th style="width: 10%;">2</th> <th style="width: 10%;">3</th> <th style="width: 10%;">4</th> </tr> </thead> <tbody> <tr> <td>Temp. (°C)</td> <td>-25±3</td> <td>+25±2</td> <td>+85±3</td> <td>+25±2</td> </tr> <tr> <td>Time (min.)</td> <td>30±3</td> <td>10 max.</td> <td>30±3</td> <td>10 max.</td> </tr> </tbody> </table> <p style="text-align: center;">Table 3: PVZ</p> <table border="1" style="width: 50%; border-collapse: collapse; margin-bottom: 10px;"> <thead> <tr style="background-color: #f2f2f2;"> <th style="width: 10%;">Sequence</th> <th style="width: 10%;">1</th> <th style="width: 10%;">2</th> <th style="width: 10%;">3</th> <th style="width: 10%;">4</th> </tr> </thead> <tbody> <tr> <td>Temp. (°C)</td> <td>-55±3</td> <td>+25±2</td> <td>+125±3</td> <td>+25±2</td> </tr> <tr> <td>Time (min.)</td> <td>30±3</td> <td>10 max.</td> <td>30±3</td> <td>10 max.</td> </tr> </tbody> </table> <p style="text-align: center;">Table 4: PVA2/PVM4A□□□C01</p>	Sequence	1	2	3	4	Temp. (°C)	-25±3	+25±2	+85±3	+25±2	Time (min.)	30±3	10 max.	30±3	10 max.	Sequence	1	2	3	4	Temp. (°C)	-55±3	+25±2	+125±3	+25±2	Time (min.)	30±3	10 max.	30±3	10 max.		
Sequence	1	2	3	4																														
Temp. (°C)	-25±3	+25±2	+85±3	+25±2																														
Time (min.)	30±3	10 max.	30±3	10 max.																														
Sequence	1	2	3	4																														
Temp. (°C)	-55±3	+25±2	+125±3	+25±2																														
Time (min.)	30±3	10 max.	30±3	10 max.																														
8	Temperature Coefficient of Resistance	<p>The trimmer potentiometer should be subjected to each of the following temperatures (see Table 5, Table 6) for 30 to 40 minutes. The resistance value should be measured in the chamber.</p> $TCR = \frac{R_2 - R_1}{R_1 (T_2 - T_1)} \times 10^6 \text{ (ppm/°C)}$ <p style="margin-left: 40px;">T₁ : Reference temperature in degrees celsius R₁ : Resistance at reference temperature in ohm</p> <p style="margin-left: 40px;">T₂ : Test temperature in degrees celsius R₂ : Resistance at test temperature in ohm</p> <table border="1" style="width: 50%; border-collapse: collapse; margin-bottom: 10px;"> <thead> <tr style="background-color: #f2f2f2;"> <th style="width: 10%;">Sequence</th> <th style="width: 10%;">1*</th> <th style="width: 10%;">2</th> <th style="width: 10%;">3*</th> <th style="width: 10%;">4</th> </tr> </thead> <tbody> <tr> <td>Temp. (°C)</td> <td>+25±2</td> <td>-25±3</td> <td>+25±2</td> <td>+85±3</td> </tr> </tbody> </table> <p style="text-align: center;">Table 5: PVZ</p> <table border="1" style="width: 50%; border-collapse: collapse; margin-bottom: 10px;"> <thead> <tr style="background-color: #f2f2f2;"> <th style="width: 10%;">Sequence</th> <th style="width: 10%;">1*</th> <th style="width: 10%;">2</th> <th style="width: 10%;">3*</th> <th style="width: 10%;">4</th> </tr> </thead> <tbody> <tr> <td>Temp. (°C)</td> <td>+25±2</td> <td>-55±3</td> <td>+25±2</td> <td>+125±3</td> </tr> </tbody> </table> <p style="text-align: center;">Table 6: PVA2/PVM4A□□□C01</p> <p>Note*: Norm temp.</p>	Sequence	1*	2	3*	4	Temp. (°C)	+25±2	-25±3	+25±2	+85±3	Sequence	1*	2	3*	4	Temp. (°C)	+25±2	-55±3	+25±2	+125±3												
Sequence	1*	2	3*	4																														
Temp. (°C)	+25±2	-25±3	+25±2	+85±3																														
Sequence	1*	2	3*	4																														
Temp. (°C)	+25±2	-55±3	+25±2	+125±3																														
9	Rotational Life	The wiper should be rotated over 90% of the effective rotational angle without loading at a speed of 10 cycles per minute, for 10 cycles continuously. The resistance value should be measured after keeping the potentiometer in a room for 10±5 minutes.																																

SMD Sealed Type (PVG3/M4A_D01/G5)/Lead Sealed Type (PV32/12/37/36) Specifications and Test Methods

The following describes trimmer potentiometer testing conducted by Murata Manufacturing Co., Ltd. in accordance with MIL-R-22097 (military specification for variable resistors, non-wirewound) and MIL-STD-202 (test methods for electronic and electrical component parts).

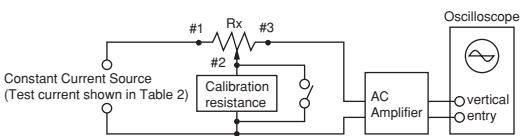
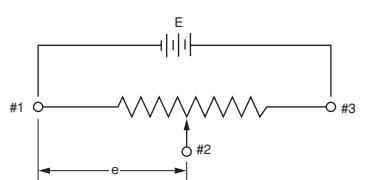
No.	Item	Test Methods																				
1	Total Resistance	<p>Measure total resistance between the resistance element and terminals (#1 and #3) with the contact arm positioned against a stop. The positioning of the contact arm and terminal should be the same for subsequent total resistance measurements on the same device. Use the test voltage specified in Table 1 for total resistance measurements. This voltage should be used for all subsequent total resistance measurements.</p> <table border="1" style="margin-left: auto; margin-right: auto; border-collapse: collapse;"> <thead> <tr style="background-color: #f2f2f2;"> <th>Total Resistance, Nominal (ohm)</th> <th>Maximum Test Voltage (V)</th> </tr> </thead> <tbody> <tr> <td>10≤R≤100</td> <td>1.0</td> </tr> <tr> <td>100<R≤1k</td> <td>3.0</td> </tr> <tr> <td>1k<R≤10k</td> <td>10.0</td> </tr> <tr> <td>10k<R≤100k</td> <td>30.0</td> </tr> <tr> <td>100k<R</td> <td>100.0</td> </tr> </tbody> </table> <p style="text-align: center;">Table 1: Total resistance test voltage</p>	Total Resistance, Nominal (ohm)	Maximum Test Voltage (V)	10≤R≤100	1.0	100<R≤1k	3.0	1k<R≤10k	10.0	10k<R≤100k	30.0	100k<R	100.0								
Total Resistance, Nominal (ohm)	Maximum Test Voltage (V)																					
10≤R≤100	1.0																					
100<R≤1k	3.0																					
1k<R≤10k	10.0																					
10k<R≤100k	30.0																					
100k<R	100.0																					
2	Residual Resistance	<p>Position the contact arm at the extreme counterclockwise limit of mechanical travel and measure the resistance between the contact arm and the corresponding end terminal. Then, position the contact arm at the extreme clockwise limit of mechanical travel and measure the resistance between the contact arm and the corresponding end terminal. During this test, take suitable precautions to ensure that the rated current of the resistance element is not exceeded.</p>																				
3	Contact Resistance Variation	<p>Contact resistance variation should be measured with the measuring circuit shown in Figure 1, or its equivalent. The adjustment rotor (screw) should be rotated in both directions through 90% of the actual effective-electrical rotational angle (number of turns) for a total of 6 cycles. Only the last 3 cycles should count in determining whether or not a contact resistance variation is observed at least twice in the same location, exclusive of the roll-on or roll-off points where the contact arm moves from the termination, on or off, the resistance element. The rate of rotation of the adjustment rotor (screw) should be such that the adjustment rotor (screw) completes 1 cycle for 5 seconds minimum to 2 minutes maximum. The test current used should follow the value given in Table 2 unless otherwise limited by power rating.</p> <table border="1" style="margin-left: auto; margin-right: auto; border-collapse: collapse;"> <thead> <tr style="background-color: #f2f2f2;"> <th>Standard Total Resistance R (ohm)</th> <th>Test Current</th> </tr> </thead> <tbody> <tr> <td>R≤100</td> <td>20mA</td> </tr> <tr> <td>100<R<500</td> <td>10mA</td> </tr> <tr> <td>500≤R<1k</td> <td>4mA</td> </tr> <tr> <td>1k≤R<2k</td> <td>2mA</td> </tr> <tr> <td>2k≤R<50k</td> <td>1mA</td> </tr> <tr> <td>50k≤R<200k</td> <td>200μA</td> </tr> <tr> <td>200k≤R<1M</td> <td>100μA</td> </tr> <tr> <td>1M≤R<2M</td> <td>50μA</td> </tr> <tr> <td>2M≤R</td> <td>30μA</td> </tr> </tbody> </table> <p style="text-align: center;">Table 2: Test current for CRV</p> <div style="text-align: right;">  <p>Rx : Trimmer Potentiometer Oscilloscope bandwidth :100Hz to 50kHz</p> <p style="text-align: center;">Figure 1: CRV measuring circuit</p> </div>	Standard Total Resistance R (ohm)	Test Current	R≤100	20mA	100<R<500	10mA	500≤R<1k	4mA	1k≤R<2k	2mA	2k≤R<50k	1mA	50k≤R<200k	200μA	200k≤R<1M	100μA	1M≤R<2M	50μA	2M≤R	30μA
Standard Total Resistance R (ohm)	Test Current																					
R≤100	20mA																					
100<R<500	10mA																					
500≤R<1k	4mA																					
1k≤R<2k	2mA																					
2k≤R<50k	1mA																					
50k≤R<200k	200μA																					
200k≤R<1M	100μA																					
1M≤R<2M	50μA																					
2M≤R	30μA																					
4	Temperature Coefficient of Resistance	<p>The trimmer potentiometer should be subjected to each of the following temperatures (see Table 3) for 30-45 minutes. Temperature coefficient of resistance should be applied to the following formula.</p> $TCR = \frac{R_2 - R_1}{R_1 (T_2 - T_1)} \times 10^6 \text{ (ppm/}^\circ\text{C)}$ <p style="margin-left: 20px;"> T₁ : Reference temperature in degrees celsius T₂ : Test temperature in degrees celsius R₁ : Resistance at reference temperature in ohm R₂ : Resistance at test temperature in ohm</p> <table border="1" style="margin-left: auto; margin-right: auto; border-collapse: collapse; text-align: center;"> <thead> <tr style="background-color: #f2f2f2;"> <th>Sequence</th> <th>1*</th> <th>2</th> <th>3</th> <th>4*</th> <th>5</th> <th>6</th> </tr> </thead> <tbody> <tr> <td>Temperature (°C)</td> <td>+25</td> <td>-15</td> <td>Min. operating Temperature</td> <td>+25</td> <td>+65</td> <td>Max. operating Temperature</td> </tr> </tbody> </table> <p>Note*: Reference temperature</p> <p style="text-align: center;">Table 3: Test temperatures</p>	Sequence	1*	2	3	4*	5	6	Temperature (°C)	+25	-15	Min. operating Temperature	+25	+65	Max. operating Temperature						
Sequence	1*	2	3	4*	5	6																
Temperature (°C)	+25	-15	Min. operating Temperature	+25	+65	Max. operating Temperature																
5	Voltage Setting Stability	<p>The wiper should be set at approximately 40% of the actual effective-electrical rotational angle (number of turns). An adequate DC test potential should be applied between terminal #1 and terminal #3. The voltage between terminal #1 and terminal #3, and the voltage between terminal #1 and terminal #2, should be measured and applied to the following formula.</p> $\text{Voltage setting stability} = \left(\frac{e'}{E} - \frac{e}{E} \right) \times 100 \text{ (\%)}$ <p style="margin-left: 20px;"> e : Before test (The voltage between terminal #1 and terminal #2) e' : After test (The voltage between terminal #1 and terminal #2)</p> <div style="text-align: right;">  <p style="text-align: center;">Figure 2</p> </div>																				

Continued on the following page.

SMD Sealed Type (PVG3/M4A_D01/G5)/Lead Sealed Type (PV32/12/37/36) Specifications and Test Methods

Continued from the preceding page.

No.	Item	Test Methods															
6	Temperature Cycle	<p>The trimmer potentiometer should be subjected to Table 4 temperature for 5 cycles. The trimmer potentiometer should be removed from the chamber, and maintained at a temperature of 25±5°C for 1-2 hours.</p> <table border="1" style="margin-left: auto; margin-right: auto; border-collapse: collapse;"> <thead> <tr style="background-color: #f2f2f2;"> <th style="text-align: left;">Sequence</th> <th style="text-align: center;">1</th> <th style="text-align: center;">2</th> <th style="text-align: center;">3</th> <th style="text-align: center;">4</th> </tr> </thead> <tbody> <tr> <td style="text-align: left;">Temp. (°C) PV□□ series</td> <td style="text-align: center;">-55±3</td> <td style="text-align: center;">+25±2</td> <td style="text-align: center;">+125±3</td> <td style="text-align: center;">+25±2</td> </tr> <tr> <td style="text-align: left;">Time (min.)</td> <td style="text-align: center;">30</td> <td style="text-align: center;">5 max.</td> <td style="text-align: center;">30</td> <td style="text-align: center;">5 max.</td> </tr> </tbody> </table> <p style="text-align: center;">Table 4: One cycle of temperature cycle.</p>	Sequence	1	2	3	4	Temp. (°C) PV□□ series	-55±3	+25±2	+125±3	+25±2	Time (min.)	30	5 max.	30	5 max.
Sequence	1	2	3	4													
Temp. (°C) PV□□ series	-55±3	+25±2	+125±3	+25±2													
Time (min.)	30	5 max.	30	5 max.													
7	Humidity	<p>1) PV12, PV32, PVM4A□□□D01 series The trimmer potentiometer should be placed in a chamber at a temperature of 40±2°C and a humidity of 90-95% without loading for 250±8 hours (500±12 hours for PVM4A□□□D01 series). The trimmer potentiometer should be removed from the chamber, and maintained at a temperature of 25±5°C for 5±1/6 hours.</p> <p>2) PVG3, PVG5, PV36, PV37 series The trimmer potentiometer should be subjected to the programmed humidity environment for 10 cycle (see Figure 3). The trimmer potentiometer should be removed from the chamber, and maintained at a temperature of 25±5°C for 1.5±1/2 hours.</p> <div style="text-align: right; font-size: small; margin-bottom: 5px;">MIL-STD-202 METHOD 106</div> <p style="text-align: center;">Figure 3</p>															
8	Vibration	<p>1) PV□□ series The trimmer potentiometer should be vibrated throughout the frequency range at the 20G level. A complete frequency range, 10Hz to 2000Hz and back, should be made within 15 minutes for a total of 4 sweeps in each of the three axis directions for a total of 12 sweeps.</p>															
9	Shock	<p>1) PV□□ series The trimmer potentiometer should be shocked at the 100G level and should be subjected to 4 shocks in each of the three axis directions for a total of 12 shocks.</p> <p>2) PVM4A□□□D01 series The trimmer potentiometer should be shocked at the 100G level and should be subjected to 3 shocks in each of the six axis directions for a total of 18 shocks.</p>															
10	Temperature Load Life	<p>Full rated continuous working voltage not exceeding the maximum rated voltage should be applied intermittently between terminal #1 and terminal #3 of the trimmer potentiometer, 1.5 hours on and 0.5 hours off, for a total of 1000±12 hours, at a temperature of 70±2°C (85±2°C for PV37 series). The trimmer potentiometer should be removed from the chamber, and maintained at a temperature of 25±5°C for 1 to 2 hours.</p>															
11	High Temperature Exposure	<p>The trimmer potentiometer should be placed in a chamber at a temperature of 125±3°C 250±8 hours without loading. The trimmer potentiometer should be removed from the chamber, and maintained at a temperature of 25±5°C for 1 to 2 hours.</p>															
12	Low Temperature Exposure (Except for PVM4A□□□D01)	<p>The trimmer potentiometer should be placed in a chamber at a temperature of -55±3°C for 1 hours without loading. Full rated continuous working voltage not exceeding the maximum rated voltage should be applied for 45 minutes. The trimmer potentiometer should be removed from the chamber, and maintained at a temperature of 25±5°C for approximately 24 hours.</p>															
13	Low Temperature Operation (Only for PVM4A□□□D01)	<p>The trimmer potentiometer should be placed in a chamber at a temperature of -25±3°C (-55±3°C for PVM4A□□□D01 series) 48±4 hours without loading. The trimmer potentiometer should be removed from the chamber, and maintained at a temperature of 25±5°C for 1-2 hours.</p>															

Continued on the following page. ↗

SMD Sealed Type (PVG3/M4A_D01/G5)/Lead Sealed Type (PV32/12/37/36) Specifications and Test Methods

Continued from the preceding page.

No.	Item	Test Methods
14	Rotational Life	<p>1) PV□□ series Full rated continuous working voltage not exceeding the maximum rated voltage should be applied with the circuit shown in the figure. The adjustment rotor (screw) should be continuously cycled through not less than 90% of effective-electrical rotational angle (number of turns), at the rate of 1 cycle for 5 seconds minimum to 2.5 minutes maximum for total of 200 cycles.</p>  <p style="text-align: center;">Figure 4</p> <p>2) PVG3, PVG5 series The adjustment rotor (screw) should be continuously cycled though not less than 90% of effective-electrical rotational angle (number of turns), at the rate of 1 cycle for 5 seconds minimum to 2.5 minutes maximum for a total of 50 (100 for PVG5) cycles, without loading.</p> <p>3) PVM4A□□□D01 series The wiper should be rotated over 90% of the effective rotational angle without loading at a speed of 10 cycles per minute, for 100 cycles continuously.</p>

Packaging

■ Minimum Quantity

Part Number	Minimum Quantity (pcs.)	
	ø180mm reel	Bulk
PVZ2A	3000	1000
PVZ2R	3000	1000
PVA2	3000	1000
PVZ3A/H	2000	1000
PVZ3G	2500	1000
PVZ3K	1500	1000
PVG3A/G	1000	500
PVM4	500	500
PVG5A	250	100
PVG5H	500	100
PV32	—	100
PV12	—	50
PV36	—	100
PV37	—	100

■ Dimensions of Reel

PVZ2A/PVA2/PVZ3A/PVZ3G/PVZ3H



(in mm)

PVZ2R/PVZ3K/PVM4/PVG3/PVG5H



(in mm)

PVG5A



(in mm)

Continued on the following page.

Packaging

Continued from the preceding page.

■ Dimensions of Plastic Tape

PVZ2 / PVA2 / PVZ3



Part Number	A	B	C	D	I	J
PVZ2A	2.4±0.2	3.1±0.1	8.0±0.2	3.5±0.1	1.1±0.1	0.2±0.1
PVZ2R		5.1±0.2	12.0±0.2	5.5±0.1	1.0±0.1	0.3±0.1
PVA2		3.1±0.1	8.0±0.2	3.5±0.1	1.1±0.1	0.2±0.1
PVZ3A/H	3.8±0.2	1.95±0.1				
PVZ3G	3.3±0.2	1.3±0.1				
PVZ3K	5.8±0.2	12.0±0.2	5.5±0.1	2.3±0.1	0.3±0.1	

• The side containing terminals #1 and #3 faces the plastic tape pilot holes.

(in mm)

■ Dimensions of Plastic Tape

PVG3A / PVG3G / PVM4 / PVG5H



Part Number	A	B	I	J
PVG3A	4.0±0.1	4.0±0.1	2.1±0.1	0.3±0.1
PVG3G		4.9±0.1		
PVM4	4.5±0.2	5.5±0.2	2.15±0.1	0.3±0.1
PVG5H	5.4±0.2	5.8±0.2	4.0±0.1	0.4±0.1

• The side containing terminals #1 and #3 faces the plastic tape pilot holes (except PVG3).

(in mm)

Continued on the following page. ↗

Packaging

☐ Continued from the preceding page.

■ Dimensions of Plastic Tape



Recommended Adjustment Tools/Qualified Standards

■ Recommended Adjustment Tools

Trimmer Potentiometer Series	Manufacturers	Model Number	MURATA Model Number	Blade
PVZ2/PVA2	MURATA MFG.	KMDR190	KMDR190	+ Cross
PVZ3G	VESSEL MFG.	No.9000+1.7×30	KMDR080	+ Cross
PVZ3A/PVZ3H/PVG3	TORAY INDUSTRIES, INC.	SA-2225	KMDR070	– Minus (round edge)
PVM4	VESSEL MFG.	No.9000–2.6×30	KMDR120	– Minus
PVG5	VESSEL MFG.	No.9000–1.3×30	KMDR130	– Minus
others	VESSEL MFG.	No.9000–1.8×30	KMDR110	– Minus

■ For Automatic Adjustment

Trimmer Potentiometer Series	Manufacturers	Model Number	MURATA Model Number	Blade
PVZ3 PVG3	TORAY INDUSTRIES, INC	JB-2225	KMBT070	– Minus (round edge)

■ Qualified Standards

The products listed here have been produced by the ISO9001 and ISO/TS16949 certified factory.

MURATA FACTORY	Qualified Date	Standard	Qualified Number
Wuxi Murata Electronics Co.,Ltd.	May 12, 1999	UNDERWRITERS LABORATORIES INC.	A7924

* No ODCs (Ozone Depleting Chemicals) are used on all Murata's trimmer potentiometers.

⚠Note:

1. Export Control

<For customers outside Japan>

No Murata products should be used or sold, through any channels, for use in the design, development, production, utilization, maintenance or operation of, or otherwise contribution to (1) any weapons (Weapons of Mass Destruction [nuclear, chemical or biological weapons or missiles] or conventional weapons) or (2) goods or systems specially designed or intended for military end-use or utilization by military end-users.

<For customers in Japan>

For products which are controlled items subject to the "Foreign Exchange and Foreign Trade Law" of Japan, the export license specified by the law is required for export.

2. Please contact our sales representatives or product engineers before using the products in this catalog for the applications listed below, which require especially high reliability for the prevention of defects which might directly damage a third party's life, body or property, or when one of our products is intended for use in applications other than those specified in this catalog.

- | | |
|-----------------------------|--|
| ① Aircraft equipment | ② Aerospace equipment |
| ③ Undersea equipment | ④ Power plant equipment |
| ⑤ Medical equipment | ⑥ Transportation equipment (vehicles, trains, ships, etc.) |
| ⑦ Traffic signal equipment | ⑧ Disaster prevention / crime prevention equipment |
| ⑨ Data-processing equipment | ⑩ Application of similar complexity and/or reliability requirements to the applications listed above |

3. Product specifications in this catalog are as of May 2012. They are subject to change or our products in it may be discontinued without advance notice. Please check with our sales representatives or product engineers before ordering. If there are any questions, please contact our sales representatives or product engineers.
4. Please read rating and ⚠CAUTION (for storage, operating, rating, soldering, mounting and handling) in this catalog to prevent smoking and/or burning, etc.
5. This catalog has only typical specifications. Therefore, please approve our product specifications or transact the approval sheet for product specifications before ordering.
6. Please note that unless otherwise specified, we shall assume no responsibility whatsoever for any conflict or dispute that may occur in connection with the effect of our and/or a third party's intellectual property rights and other related rights in consideration of your use of our products and/or information described or contained in our catalogs. In this connection, no representation shall be made to the effect that any third parties are authorized to use the rights mentioned above under licenses without our consent.
7. No ozone depleting substances (ODS) under the Montreal Protocol are used in our manufacturing process.

Компания «Океан Электроники» предлагает заключение долгосрочных отношений при поставках импортных электронных компонентов на взаимовыгодных условиях!

Наши преимущества:

- Поставка оригинальных импортных электронных компонентов напрямую с производств Америки, Европы и Азии, а так же с крупнейших складов мира;
- Широкая линейка поставок активных и пассивных импортных электронных компонентов (более 30 млн. наименований);
- Поставка сложных, дефицитных, либо снятых с производства позиций;
- Оперативные сроки поставки под заказ (от 5 рабочих дней);
- Экспресс доставка в любую точку России;
- Помощь Конструкторского Отдела и консультации квалифицированных инженеров;
- Техническая поддержка проекта, помощь в подборе аналогов, поставка прототипов;
- Поставка электронных компонентов под контролем ВП;
- Система менеджмента качества сертифицирована по Международному стандарту ISO 9001;
- При необходимости вся продукция военного и аэрокосмического назначения проходит испытания и сертификацию в лаборатории (по согласованию с заказчиком);
- Поставка специализированных компонентов военного и аэрокосмического уровня качества (Xilinx, Altera, Analog Devices, Intersil, Interpoint, Microsemi, Actel, Aeroflex, Peregrine, VPT, Syfer, Eurofarad, Texas Instruments, MS Kennedy, Miteq, Cobham, E2V, MA-COM, Hittite, Mini-Circuits, General Dynamics и др.);

Компания «Океан Электроники» является официальным дистрибьютором и эксклюзивным представителем в России одного из крупнейших производителей разъемов военного и аэрокосмического назначения «JONHON», а так же официальным дистрибьютором и эксклюзивным представителем в России производителя высокотехнологичных и надежных решений для передачи СВЧ сигналов «FORSTAR».



JONHON

«JONHON» (основан в 1970 г.)

Разъемы специального, военного и аэрокосмического назначения:

(Применяются в военной, авиационной, аэрокосмической, морской, железнодорожной, горно- и нефтедобывающей отраслях промышленности)

«FORSTAR» (основан в 1998 г.)

ВЧ соединители, коаксиальные кабели,
кабельные сборки и микроволновые компоненты:

(Применяются в телекоммуникациях гражданского и специального назначения, в средствах связи, РЛС, а так же военной, авиационной и аэрокосмической отраслях промышленности).



Телефон: 8 (812) 309-75-97 (многоканальный)

Факс: 8 (812) 320-03-32

Электронная почта: ocean@oceanchips.ru

Web: <http://oceanchips.ru/>

Адрес: 198099, г. Санкт-Петербург, ул. Калинина, д. 2, корп. 4, лит. А