

## STEP-UP DC/DC CONVERTER with SHUTDOWN FUNCTION

NO.EA-255-151026

### OUTLINE

The R1202x Series are CMOS-based PWM step-up DC/DC converter ICs with low supply current.

Each of these ICs consists of an NMOS FET, NPN transistor, an oscillator, a PWM comparator, a voltage reference unit, an error amplifier, a current limit circuit, an under voltage lockout circuit (UVLO), an over-voltage protection circuit (OVP), a soft-start circuit, a Maxduty limit circuit, and a thermal shutdown protection circuit. By simply using an inductor, a resistor, and capacitors as external components, a high-efficiency step-up DC/DC converter can be easily configured. At the standby mode, a rectifier transistor can separate the output from the input.

The R1202x Series include a thermal shut-down circuit and an under-voltage lockout circuit (UVLO) which separate the output from the input to shut down the current when the over heat caused when the output is connected to the Gnd is detected and also during the UVLO detection. As other protection functions, the R1202x Series contain a cycle by cycle current limit circuit that limits the Lx peak current, and an over-voltage protection circuit (OVP) that detects the output overvoltage.

The R1202x Series offer three versions: the R1202xxxxA/B versions, which are optimized for constant-voltage power supply and the R1202xxxxD version, which is optimized to drive serial white LEDs with constant current. While the R1202xxxxA version discharges the V<sub>OUT</sub> output to 0V at the shutdown, the R1202xxxxB version doesn't. The brightness of the white LEDs can be adjusted quickly by applying a PWM signal (200Hz to 300kHz) to the CE pin.

The R1202x Series are available in DFN1616-6B and TSOT-23-6 packages.

### FEATURES

- Input Voltage Range .....2.3V to 5.5V (R1202xxxxA/B)  
1.8V to 5.5V (R1202xxxxD)
- Supply Current ..... Typ. 800μA
- Standby Current..... Max. 5μA
- Feedback Voltage ..... 1.0V±15mV (R1202xxxxA/B)  
0.2V±10mV (R1202xxxxD)
- Oscillator Frequency ..... Typ. 1.2MHz
- Maximum Duty Cycle ..... Typ. 91%
- UVLO Function ..... Typ.2.0V (Hys.Typ.0.2V) (R1202xxxxA/B)  
Typ.1.6V (Hys.Typ.0.1V) (R1202xxxxD)
- Lx Current Limit Function ..... Select from 350mA, 700mA
- Over Voltage Protection ..... Select from 14V-23V (Refer the Selection Guide)
- LED dimming control for R1202xxxxD ..... by external PWM signal (Frequency 200Hz to 300kHz)
- Thermal Protection Function ..... Typ.150°C(Hys.Typ.50°C)
- Built-in Auto Discharge Function..... R1202xxxxA
- NMOS ON Resistance ..... 1.35Ω
- Packages ..... DFN1616-6B, TSOT-23-6

## APPLICATION

- Constant Voltage Power Source for portable equipment
- OLED power supply for portable equipment
- White LED Backlight for portable equipment

## BLOCK DIAGRAMS

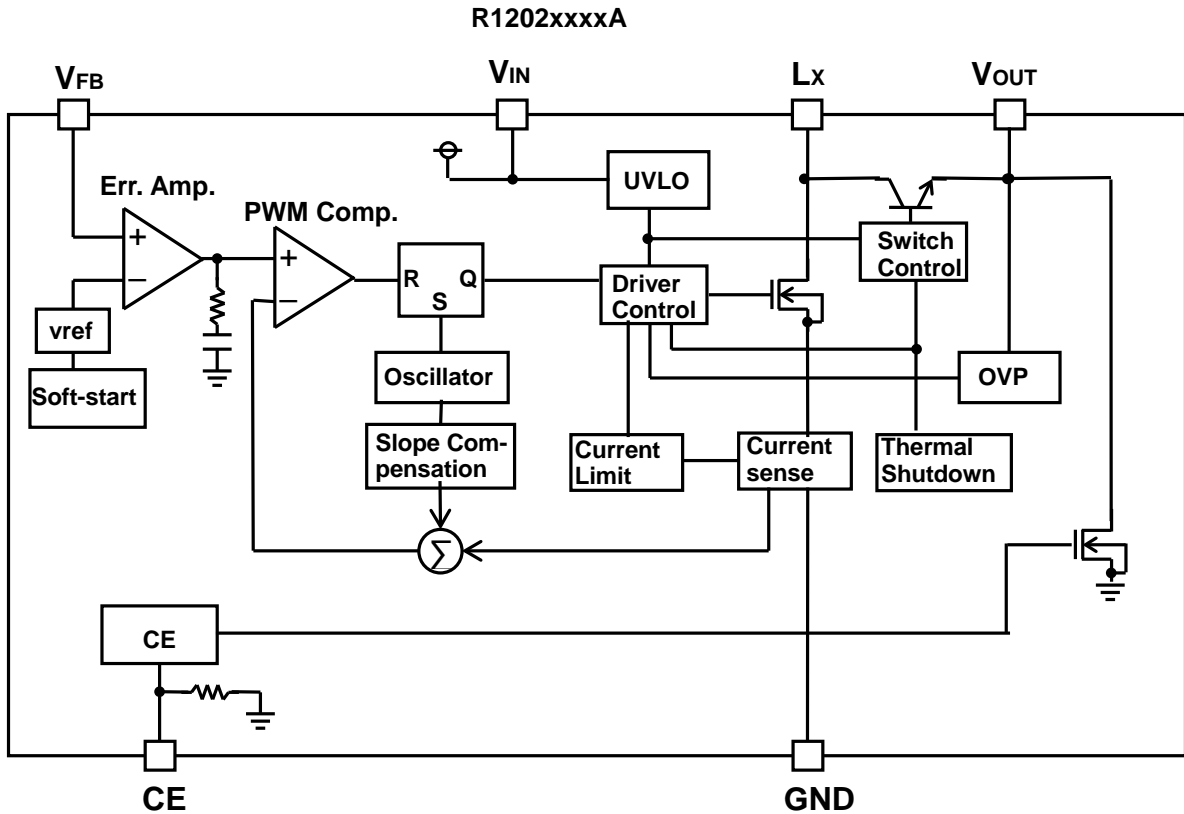

R1202xxxxB



R1202xxxxD



## SELECTION GUIDE

The OVP threshold voltage, current limit, package and V<sub>F<sub>B</sub></sub>/Auto discharge are user-selectable options.

| Product Name   | Package    | Quantity per Reel | Pb Free | Halogen Free |  |     |                |   |      |   |   |      |   |   |      |   |
|--|------------|-------------------|---------|--------------|--|-----|----------------|---|------|---|---|------|---|---|------|---|
| R1202Lyz1*-TR  | DFN1616-6B | 5,000 pcs         | Yes     | Yes          |  |     |                |   |      |   |   |      |   |   |      |   |
| R1202Nyz3*-TR-FE   | TSOT-23-6  | 3,000 pcs         | Yes     | Yes          |  |     |                |   |      |   |   |      |   |   |      |   |
| <p>y : Designation of OVP threshold</p> <p>(3) 14V : R1202xxxxA/B/D</p> <p>(4) 17V : R1202xxxxA/B</p> <p>(5) 19V : R1202xxxxA/B</p> <p>(6) 21V : R1202xxxxA/B</p> <p>(7) 23V : R1202xxxxA/B/D</p>  |            |                   |         |              |  |     |                |   |      |   |   |      |   |   |      |   |
| <p>z : Designation of current limit</p> <p>(1) 350mA</p> <p>(2) 700mA</p>  |            |                   |         |              |  |     |                |   |      |   |   |      |   |   |      |   |
| <p>* : Designation of VFB, auto discharge function</p> <table border="1" style="margin-left: auto; margin-right: auto;"> <thead> <tr> <th></th> <th>VFB</th> <th>Auto discharge</th> </tr> </thead> <tbody> <tr> <td>A</td> <td>1.0V</td> <td>○</td> </tr> <tr> <td>B</td> <td>1.0V</td> <td>×</td> </tr> <tr> <td>D</td> <td>0.2V</td> <td>×</td> </tr> </tbody> </table> |            |                   |         |              |  | VFB | Auto discharge | A | 1.0V | ○ | B | 1.0V | × | D | 0.2V | × |
|  | VFB        | Auto discharge    |         |              |  |     |                |   |      |   |   |      |   |   |      |   |
| A  | 1.0V       | ○                 |         |              |  |     |                |   |      |   |   |      |   |   |      |   |
| B  | 1.0V       | ×                 |         |              |  |     |                |   |      |   |   |      |   |   |      |   |
| D  | 0.2V       | ×                 |         |              |  |     |                |   |      |   |   |      |   |   |      |   |

Auto-discharge function quickly lowers the output voltage to 0V, when the chip enable signal is switched from the active mode to the standby mode, by releasing the electrical charge accumulated in the external capacitor.

## PIN CONFIGURATIONS

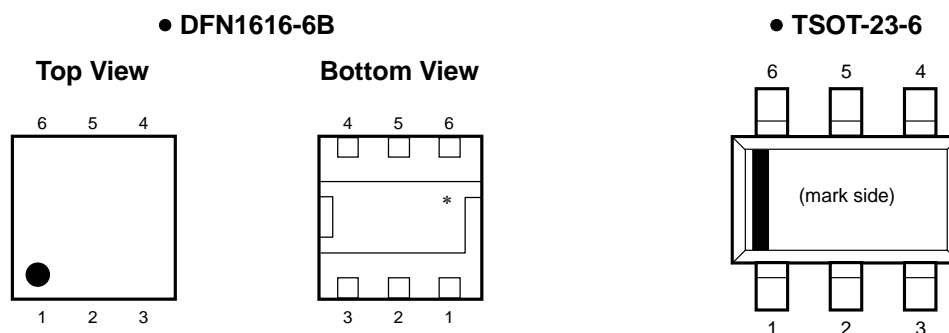

## PIN DESCRIPTIONS

### • DFN1616-6B

| Pin No | Symbol    | Pin Description                   |
|--------|-----------|-----------------------------------|
| 1      | CE        | Chip Enable Pin ("H" Active)      |
| 2      | $V_{FB}$  | Feedback Pin                      |
| 3      | $L_X$     | Switching Pin (Open Drain Output) |
| 4      | GND       | Ground Pin                        |
| 5      | $V_{IN}$  | Input Pin                         |
| 6      | $V_{OUT}$ | Output Pin                        |

\*) The tab is substrate level (GND). The tab is better to be connected to the GND, but leaving it open is also acceptable.

### • TSOT-23-6

| Pin No | Symbol    | Pin Description                   |
|--------|-----------|-----------------------------------|
| 1      | CE        | Chip Enable Pin ("H" Active)      |
| 2      | $V_{OUT}$ | Output Pin                        |
| 3      | $V_{IN}$  | Input Pin                         |
| 4      | $L_X$     | Switching Pin (Open Drain Output) |
| 5      | GND       | Ground Pin                        |
| 6      | $V_{FB}$  | Feedback Pin                      |

**ABSOLUTE MAXIMUM RATINGS**

(GND=0V)

| Symbol           | Item                             | Rating      | Unit |
|------------------|----------------------------------|-------------|------|
| V <sub>IN</sub>  | V <sub>IN</sub> Pin Voltage      | -0.3 to 6.5 | V    |
| V <sub>CE</sub>  | CE Pin Voltage                   | -0.3 to 6.5 | V    |
| V <sub>FB</sub>  | V <sub>FB</sub> Pin Voltage      | -0.3 to 6.5 | V    |
| V <sub>OUT</sub> | V <sub>OUT</sub> Pin Voltage     | -0.3 to 25  | V    |
| V <sub>LX</sub>  | L <sub>x</sub> Pin Voltage       | -0.3 to 25  | V    |
| I <sub>LX</sub>  | L <sub>x</sub> Pin Current       | 1000        | mA   |
| P <sub>D</sub>   | Power Dissipation (DFN1616-6B) * | 640         | mW   |
|                  | Power Dissipation (TSOT-23-6) *  | 460         |      |
| T <sub>a</sub>   | Operating Temperature Range      | -40 to 85   | °C   |
| T <sub>stg</sub> | Storage Temperature Range        | -55 to 125  | °C   |

\*) For Power Dissipation, please refer to PACKAGE INFORMATION.

**ABSOLUTE MAXIMUM RATINGS**

Electronic and mechanical stress momentarily exceeded absolute maximum ratings may cause the permanent damages and may degrade the life time and safety for both device and system using the device in the field. The functional operation at or over these absolute maximum ratings is not assured.

**RECOMMENDED OPERATING CONDITIONS (ELECTRICAL CHARACTERISTICS)**

All of electronic equipment should be designed that the mounted semiconductor devices operate within the recommended operating conditions. The semiconductor devices cannot operate normally over the recommended operating conditions, even if when they are used over such conditions by momentary electronic noise or surge. And the semiconductor devices may receive serious damage when they continue to operate over the recommended operating conditions.

## ELECTRICAL CHARACTERISTICS

## • R1202x

(Ta=25°C)

| Symbol                | Item  | Conditions  | Min.         | Typ.  | Max.                    | Unit   |    |
|-----------------------|---|---|--------------|-------|-------------------------|--------|----|
| V <sub>IN</sub>       | Operating Input Voltage                         | R1202xxxxA/B  | 2.3          |       | 5.5                     | V      |    |
|                       |   | R1202xxxxD  | 1.8          |       | 5.5                     | V      |    |
| I <sub>DD</sub>       | Supply Current                                  | V <sub>IN</sub> =5.5V, V <sub>FB</sub> =0V, L <sub>X</sub> at no load |              | 0.8   | 1.2                     | mA     |    |
| I <sub>standby</sub>  | Standby Current                                 | V <sub>IN</sub> =5.5V, V <sub>CE</sub> =0V                            |              | 1.0   | 5.0                     | μA     |    |
| V <sub>UVLO1</sub>    | UVLO Detect Threshold Voltage                   | V <sub>IN</sub> falling   | R1202xxxxA/B | 1.9   | 2.0                     | 2.1    | V  |
|                       |   |   | R1202xxxxD   | 1.5   | 1.6                     | 1.7    | V  |
| V <sub>UVLO2</sub>    | UVLO Release Voltage                            | V <sub>IN</sub> rising  | R1202xxxxA/B |       | V <sub>UVLO1</sub> +0.2 | 2.3    | V  |
|                       |   |   | R1202xxxxD   |       | V <sub>UVLO1</sub> +0.1 | 1.8    | V  |
| V <sub>CEH</sub>      | CE Input Voltage "H"                            | V <sub>IN</sub> =5.5V   | 1.5          |       |                         | V      |    |
| V <sub>CEL</sub>      | CE Input Voltage "L"                            | V <sub>IN</sub> =1.8V   |              |       | 0.5                     | V      |    |
| R <sub>CE</sub>       | CE Pull Down Resistance                         |   |              | 1200  |                         | kΩ     |    |
| V <sub>FB</sub>       | V <sub>FB</sub> Voltage Accuracy                | V <sub>CE</sub> =3.6V   | R1202xxxxA/B | 0.985 | 1.000                   | 1.015  | V  |
|                       |   |   | R1202xxxxD   | 0.19  | 0.2                     | 0.21   |    |
| ΔV <sub>FB</sub> /ΔTa | V <sub>FB</sub> Voltage Temperature Coefficient | V <sub>CE</sub> =3.6V, -40°C ≤ Ta ≤ 85°C                              |              | ±150  |                         | ppm/°C |    |
| I <sub>FB</sub>       | V <sub>FB</sub> Input Current                   | V <sub>IN</sub> =5.5V, V <sub>FB</sub> =0V or 5.5V                    | -0.1         |       | 0.1                     | μA     |    |
| t <sub>start</sub>    | Soft-start Time                                 | *R1202xxxxA/B   |              | 2.0   |                         | ms     |    |
| R <sub>ON</sub>       | Driver ON Resistance                            | V <sub>CE</sub> =3.6V, I <sub>LX</sub> =100mA                         |              | 1.35  |                         | Ω      |    |
| I <sub>OFF</sub>      | Driver Leakage Current                          | V <sub>LX</sub> =22V  |              |       | 3.0                     | μA     |    |
| I <sub>LIM</sub>      | Driver Current Limit                            | V <sub>IN</sub> =3.6V   | R1202xx1xx   | 250   | 350                     | 450    | mA |
|                       |   |   | R1202xx2xx   | 500   | 700                     | 900    |    |
| V <sub>F</sub>        | NPN Forward Voltage                             | I <sub>LX</sub> =100mA  |              | 0.8   |                         | V      |    |
| I <sub>SWOFF1</sub>   | NPN Leakage Current 1                           | V <sub>OUT</sub> =22V, V <sub>LX</sub> =0V                            |              |       | 10                      | μA     |    |
| I <sub>SWOFF2</sub>   | NPN Leakage Current 2                           | V <sub>OUT</sub> =0V, V <sub>LX</sub> =5.5V                           |              |       | 3                       | μA     |    |
| f <sub>osc</sub>      | Oscillator Frequency                            | V <sub>IN</sub> =3.6V, V <sub>FB</sub> =0V                            | 1000         | 1200  | 1400                    | kHz    |    |

## R1202x

(Ta=25°C)

| Symbol     | Item                                 | Conditions                           | Min.           | Typ. | Max.               | Unit |   |
|------------|--------------------------------------|--------------------------------------|----------------|------|--------------------|------|---|
| Maxduty    | Maximum Duty Cycle                   | $V_{IN}=3.6V$ , $V_{FB}=0V$          | 86             | 91   |                    | %    |   |
| $V_{OVP1}$ | OVP Detect Voltage                   | $V_{IN}=3.6V$ ,<br>$V_{OUT}$ rising  | R1202x3xxA/B/D | 13.2 | 14                 | 14.8 | V |
|            |                                      |                                      | R1202x4xxA/B   | 16.2 | 17                 | 17.8 |   |
|            |                                      |                                      | R1202x5xxA/B   | 18.2 | 19                 | 19.8 |   |
|            |                                      |                                      | R1202x6xxA/B   | 20.2 | 21                 | 21.8 |   |
|            |                                      |                                      | R1202x7xxA/B/D | 22.2 | 23                 | 23.8 |   |
| $V_{OVP2}$ | OVP Release Voltage                  | $V_{IN}=3.6V$ ,<br>$V_{OUT}$ falling | R1202x3xxA/B/D |      | $V_{OVP1}$<br>-1.1 |      | V |
|            |                                      |                                      | R1202x4xxA/B   |      | $V_{OVP1}$<br>-1.3 |      |   |
|            |                                      |                                      | R1202x5xxA/B   |      | $V_{OVP1}$<br>-1.4 |      |   |
|            |                                      |                                      | R1202x6xxA/B   |      | $V_{OVP1}$<br>-1.5 |      |   |
|            |                                      |                                      | R1202x7xxA/B/D |      | $V_{OVP1}$<br>-1.7 |      |   |
| $T_{TSD}$  | Thermal Shutdown Detect Temperature  | $V_{IN}=3.6V$                        |                | 150  |                    | °C   |   |
| $T_{TSR}$  | Thermal Shutdown Release Temperature | $V_{IN}=3.6V$                        |                | 100  |                    | °C   |   |



## TYPICAL APPLICATIONS

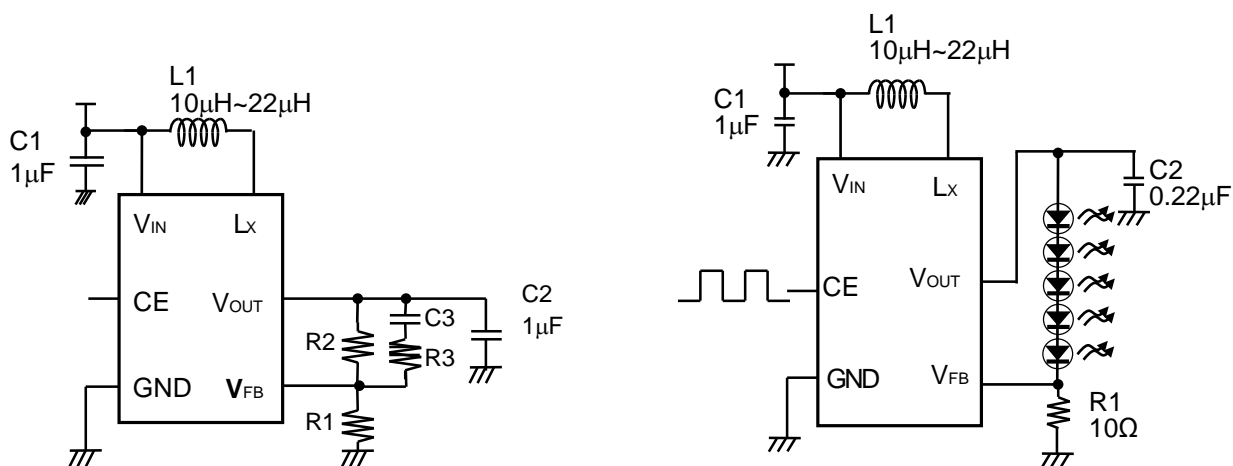

R1202xxxxA/B

R1202xxxxD

## Recommended inductors

| L1 (µH) | Parts No      | Rated Current(mA) | Size(mm)     |
|---------|---------------|-------------------|--------------|
| 10      | LQH32CN100K53 | 450               | 3.2×2.5×1.55 |
| 10      | LQH2MCN100K02 | 225               | 2.0×1.6×0.9  |
| 10      | VLF3010A-100  | 490               | 2.8×2.6×0.9  |
| 22      | LQH32CN220K53 | 250               | 3.2×2.5×1.55 |
| 22      | LQH2MCN220K02 | 185               | 2.0×1.6×0.9  |
| 22      | VLF3010A-220  | 330               | 2.8×2.6×0.9  |

## Recommended components for R1202xxxxA/B

|    | Rated voltage(V) | Part No.                     |
|----|------------------|------------------------------|
| C1 | 6.3              | CM105B105K06                 |
| C2 | 25               | GRM21BR11E105K               |
| C3 | 25               | 220pF                        |
| R1 |                  | For V <sub>OUT</sub> Setting |
| R2 |                  | For V <sub>OUT</sub> Setting |
| R3 |                  | 2kΩ                          |

## Recommended components for R1202xxxxD

|    | Rated voltage(V) | Part No.      |
|----|------------------|---------------|
| C1 | 6.3              | CM105B105K06  |
| C2 | 25               | GRM21BR11E224 |

- **The Method of Output Voltage Setting ( R1202xxxxA/B )**

The output voltage ( $V_{OUT}$ ) can be calculated with divider resistors ( $R1$  and  $R2$ ) values as the following formula:

$$\text{Output Voltage (} V_{OUT} \text{)} = V_{FB} \times (R1 + R2) / R1$$

The total value of  $R1$  and  $R2$  should be equal or less than  $300k\Omega$ . Make the  $V_{IN}$  and GND line sufficient. The large current flows through the  $V_{IN}$  and GND line due to the switching. If this impedance ( $V_{IN}$  and GND line) is high, the internal voltage of the IC may shift by the switching current, and the operating may become unstable. Moreover, when the built-in  $Lx$  switch is turn OFF, the spike noise caused by the inductor may be generated. As a result of this, recommendation voltage rating of capacitor ( $C2$ ) value is equal 1.5 times larger or more than the setting output voltage.

- **LED Current setting ( R1202xxxxD )**

When CE pin input is "H" (Duty=100%), LED current can be set with feedback resistor ( $R1$ )

$$I_{LED} = V_{FB} / R1$$

- **LED Dimming Control ( R1202xxxxD )**

The LED brightness can be controlled by inputting the PWM signal to the CE pin. If the CE pin input is "L" in the fixed time (Typ.0.5ms), the IC becomes the standby mode and turns OFF LEDs.

The current of LEDs can be controlled by Duty of the PWM signal of the input CE pin. The current of LEDs when High-Duty of the CE input is "Hduty" reaches the value as calculatable following formula.

$$I_{LED} = Hduty \times V_{FB} / R1$$

The frequency of the PWM signal is using the range between 200Hz to 300kHz.

When controlling the LED brightness by the PWM signal of 20kHz or less, the increasing or decreasing of the inductor current might be make a sounds in the hearable sound wave area. In that case, please use the PWM signal in the high frequency area.



**Dimming control by CE pin input**

- **Soft-Start ( R1202xxxxA/B )**

The output and reference of the error amplifier start from 0V and the reference gradually rises up to 1.0V. After the softstart time ( $T_{SS}$ ), output voltage rise up to the setting voltage.

- **Shutdown**

At standby mode, the output is completely separated from the input and shutdown by the NPN transistor of internal IC. However, the leakage current is generated when the  $L_x$  pin voltage is higher than  $V_{IN}$  pin voltage at standby mode.

R1202xxxxA (with auto discharge function): In the term of standby mode, the switch between  $V_{OUT}$  to GND is turned ON and output capacitor is discharged.

- **Protect Function**

If the over current is detected, internal mosfet will turn-off soon. At the next operating period, mosfet will turn-on again and continue to watch the current.

The UVLO function and the thermal shutdown function are turned off the NMOS-driver and NPN-transistor when the  $V_{IN}$  decreases more than the UVLO detect threshold voltage or the inside of IC exceeds the thermal shutdown detect temperature, and reset IC when the  $V_{IN}$  rises more than the UVLO release voltage or the inside of IC falls below the thermal shutdown release temperature, and restart the operation.

- **Selection of Inductor**

The peak current of the inductor at normal mode can be calculated as next formula:

$$I_{Lmax} = 1.25 \times I_{LED} \times V_{OUT} / V_{IN} + 0.5 \times V_{IN} \times (V_{OUT} - V_{IN}) / (L \times V_{OUT} \times f_{osc})$$

When the start-up or dimming control by CE pin, transient current flows, the peak current must be equal or less than the current limit of the IC. The peak current should not beyond the rating current of the inductor. The recommended inductance value is 10 $\mu$ H - 22 $\mu$ H.

- **Selection of Capacitor**

Set 1 $\mu$ F or more value bypass capacitor C1 between  $V_{IN}$  pin and GND pin as close as possible.

As for R1202xxxxA/B version Set 1.0 $\mu$ F – 4.7 $\mu$ F capacitor C2 between  $V_{OUT}$  pin and GND pin.

As for R1202xxxxD version, set 0.22 $\mu$ F – 1.0 $\mu$ F capacitor C2 between  $V_{OUT}$  pin and GND pin.

- **External Components Setting**

If the spike noise of  $V_{OUT}$  may be large for R1202xxxxA/B, the spike noise may be picked into  $V_{FB}$  pin and make the operation unstable. In this case, use a R3 of the resistance value in the range from 1k $\Omega$  to 5k $\Omega$  to reduce a noise level of  $V_{FB}$ .

**OPERATION OF STEP-UP DC/DC CONVERTER AND OUTPUT CURRENT**



**<Current through L>**

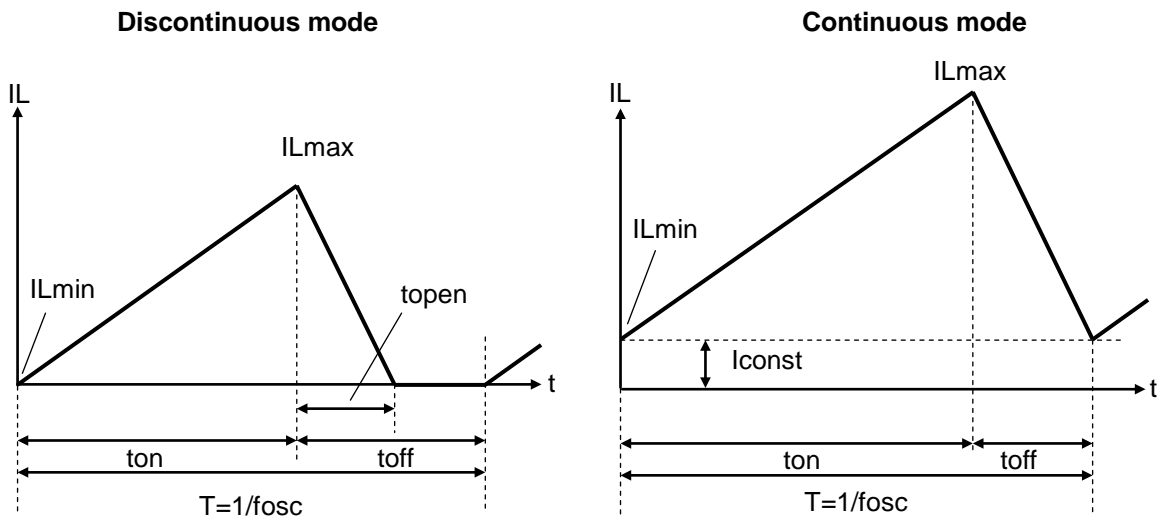

There are two operation modes of the step-up PWM control-DC/DC converter. That is the continuous mode and discontinuous mode by the continuousness inductor.

When the transistor turns ON, the voltage of inductor L becomes equal to VIN voltage. The increase value of inductor current (i1) will be

$$\Delta i1 = V_{IN} \times t_{on} / L \dots \dots \dots \text{Formula 1}$$

As the step-up circuit, during the OFF time (when the transistor turns OFF) the voltage is continually supply from the power supply. The decrease value of inductor current (i2) will be

$$\Delta i2 = (V_{OUT} - V_{IN}) \times t_{open} / L \dots \dots \dots \text{Formula 2}$$

At the PWM control-method, the inductor current become continuously when topen=toff, the DC/DC converter operate as the continuous mode.

In the continuous mode, the variation of current of  $i_1$  and  $i_2$  is same at regular condition.

$$V_{IN} \times t_{on} / L = (V_{OUT} - V_{IN}) \times t_{off} / L \dots\dots\dots \text{Formula 3}$$

The duty at continuous mode will be

$$\text{duty (\%)} = t_{on} / (t_{on} + t_{off}) = (V_{OUT} - V_{IN}) / V_{OUT} \dots\dots\dots \text{Formula 4}$$

The average of inductor current at  $t_f = t_{off}$  will be

$$I_{L1}(\text{Ave.}) = V_{IN} \times t_{on} / (2 \times L) \dots\dots\dots \text{Formula 5}$$

If the input voltage = output voltage, the  $I_{OUT}$  will be

$$I_{OUT} = V_{IN}^2 \times t_{on} / (2 \times L \times V_{OUT}) \dots\dots\dots \text{Formula 6}$$

If the  $I_{OUT}$  value is large than above the calculated value (Formula 6), it will become the continuous mode, At this status, the peak current ( $I_{Lmax}$ ) of inductor will be

$$I_{Lmax} = I_{OUT} \times V_{OUT} / V_{IN} + V_{IN} \times t_{on} / (2 \times L)$$

$$I_{Lmax} = I_{OUT} \times V_{OUT} / V_{IN} + V_{IN} \times T \times (V_{OUT} - V_{IN}) / (2 \times L \times V_{OUT}) \dots\dots\dots \text{Formula 7}$$

The peak current value is larger than the  $I_{OUT}$  value. In case of this, selecting the condition of the input and the output and the external components by considering of  $I_{Lmax}$  value.

The explanation above is based on the ideal calculation, and the loss caused by  $L_x$  switch and the external components are not included.

The actual maximum output current will be between 50% and 80% by the above calculations. Especially, when the  $I_L$  is large or  $V_{IN}$  is low, the loss of  $V_{IN}$  is generated with on resistance of the switch. Moreover, it is necessary to consider  $V_f$  of the diode (approximately 0.8V) about  $V_{OUT}$ .

## TYPICAL CHARACTERISTICS

### 1) Efficiency vs. Output Current (R1202N723A)

$V_{OUT}=10V, L=10\mu H$  (LQH32CN100K53)



$V_{OUT}=10V, L=22\mu H$  (LQH32CN220K53)

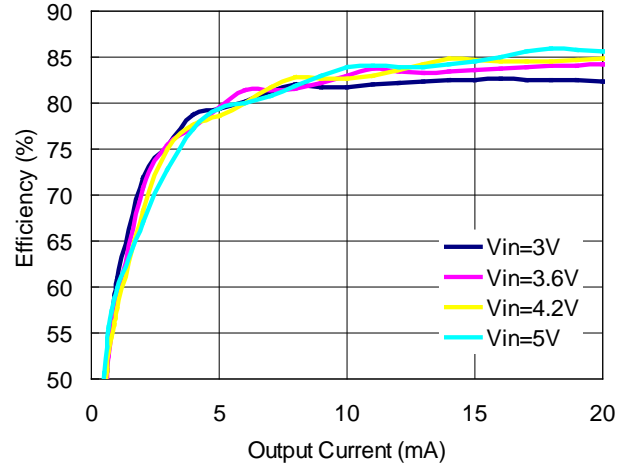

$V_{OUT}=15V, L=10\mu H$  (LQH32CN100K53)



$V_{OUT}=15V, L=22\mu H$  (LQH32CN220K53)

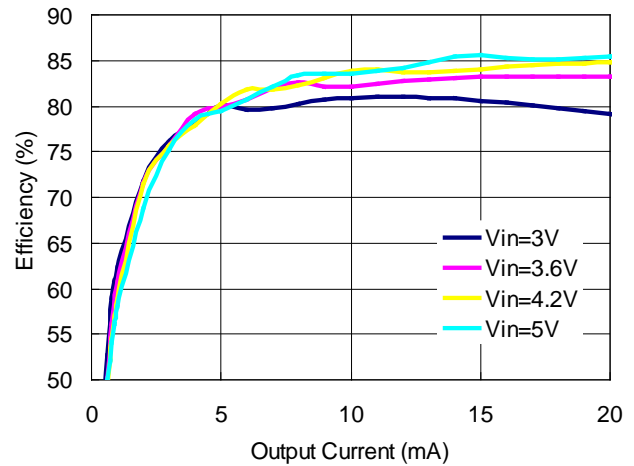

$V_{OUT}=20V, L=10\mu H$  (LQH32CN100K53)



$V_{OUT}=20V, L=22\mu H$  (LQH32CN220K53)

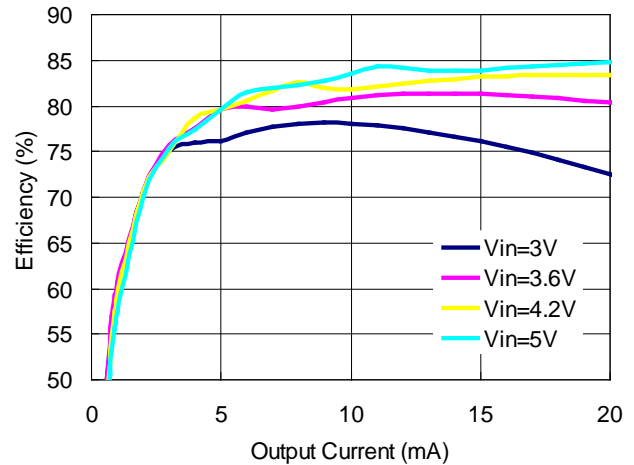

**V<sub>OUT</sub>=20V, V<sub>IN</sub>=3.6V**



**2) Efficiency vs. Output Current (R1202N713D)**

**4LED, L=10μH (LQH32CN100K53)**



**4LED, L=22μH (LQH32CN220K53)**



**5LED, L=10μH (LQH32CN100K53)**



**5LED, L=22μH (LQH32CN220K53)**



3) Efficiency vs. Output Current (R1202N713D)

5LED,  $V_{IN}=3.6V$

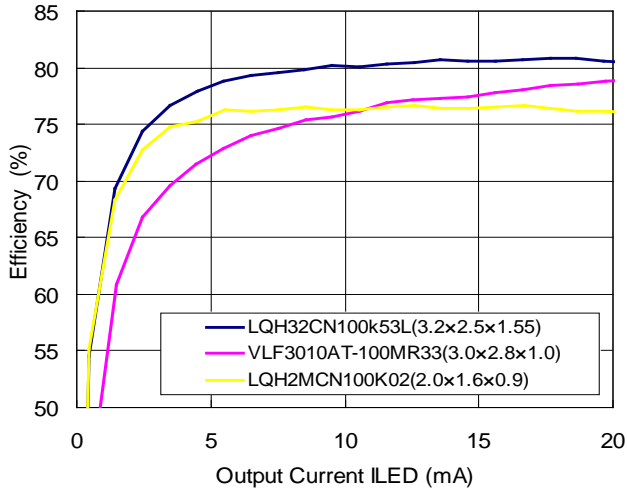

4) Output Voltage vs. Output Current (R1202N723A)

$V_{OUT}=10V$ ,  $L=10\mu H$  (LQH32CN100K53)

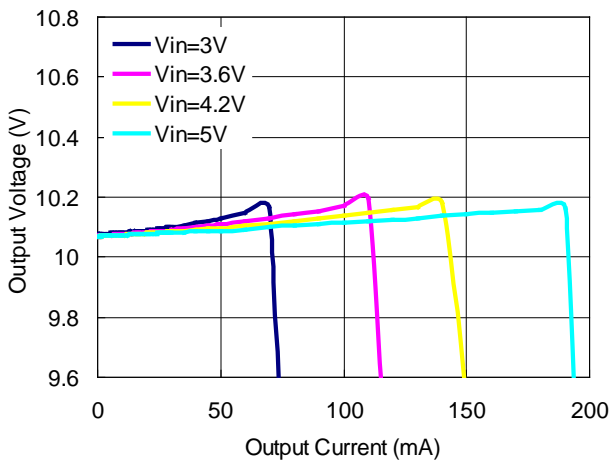

$V_{OUT}=10V$ ,  $L=22\mu H$  (LQH32CN220K53)

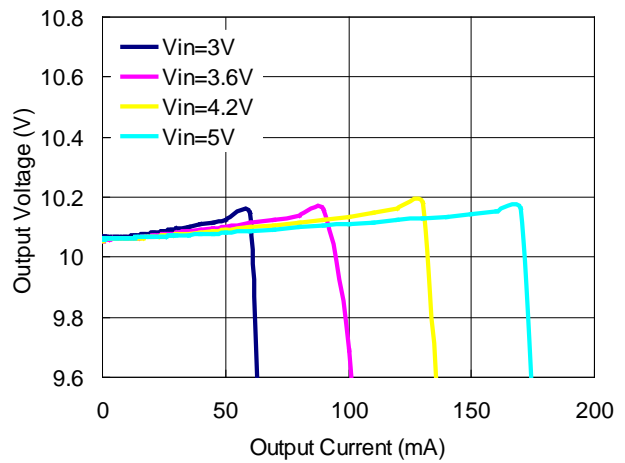

$V_{OUT}=15V$ ,  $L=10\mu H$  (LQH32CN100K53)

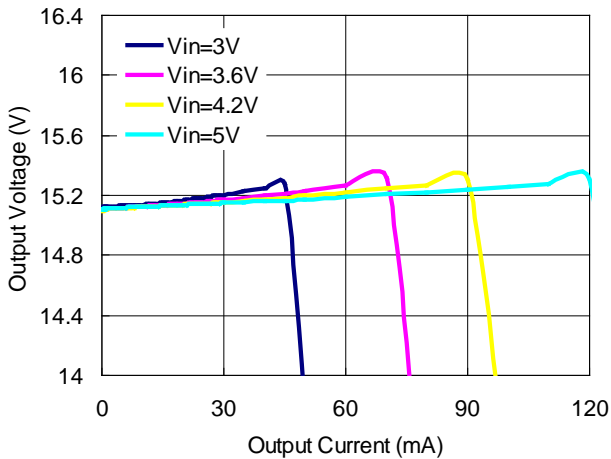

$V_{OUT}=15V$ ,  $L=22\mu H$  (LQH32CN220K53)

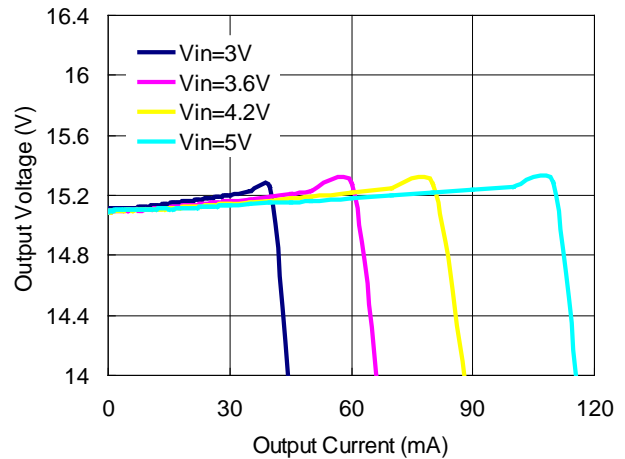



**V<sub>OUT</sub>=20V, L=10μH (LQH32CN100K53)**



**V<sub>OUT</sub>=20V, L=22μH (LQH32CN220K53)**



**V<sub>OUT</sub>=20V, V<sub>IN</sub>=3.6V**



**5) Maxduty vs. ILED**

**R1202N713D**



**6) OVP Output Waveform**

**R1202N713D**



7) Waveform (5LED)

R1202N713D (CE Freq=200Hz)



R1202N713D (CE Freq=10KHz)

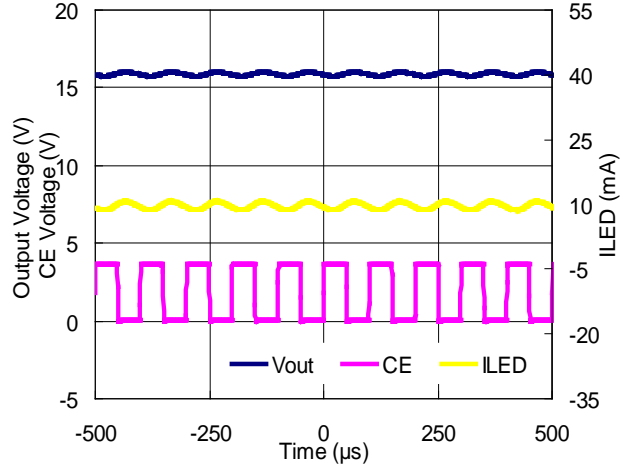

R1202N713D (CE Freq=300KHz)

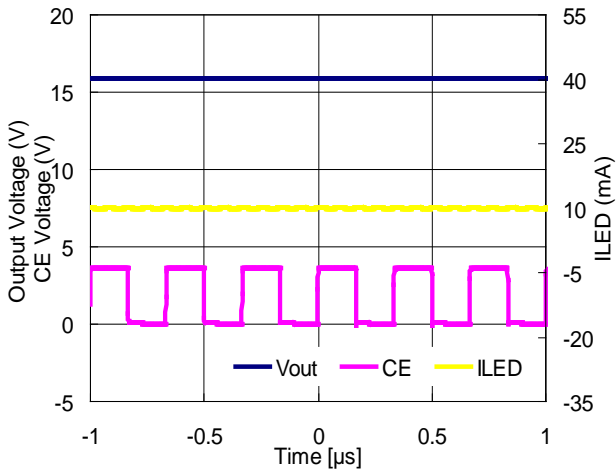

8) Diode Forward Voltage vs. Temperature

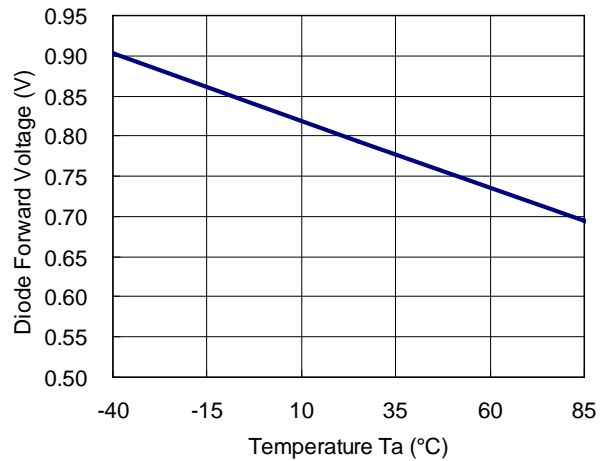

9) Standby Current vs. Temperature



10) Supply Current Iin vs. Temperature

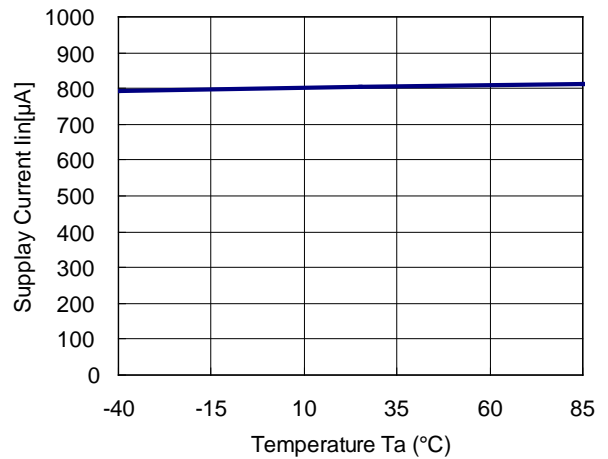

11) UVLO Voltage vs. Temperature

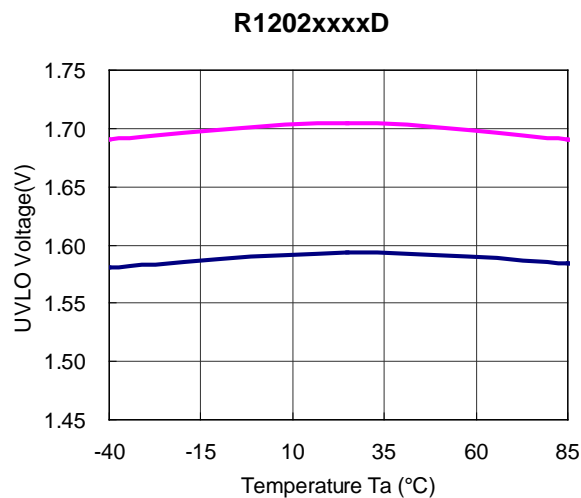
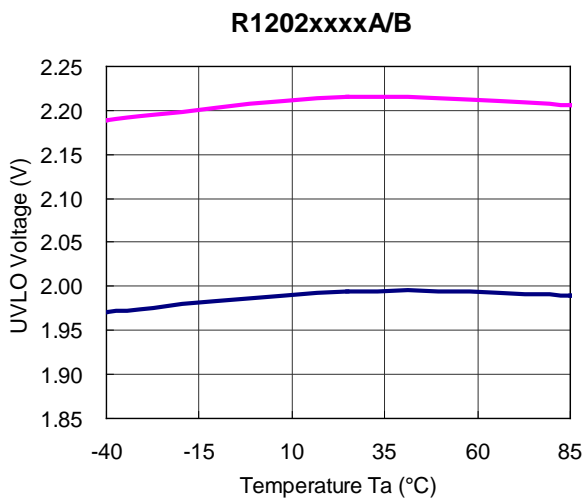

12) VFB Voltage vs. Temperature



13) Switch ON Resistance RON vs. Temperature



14) OVP Voltage vs. Temperature

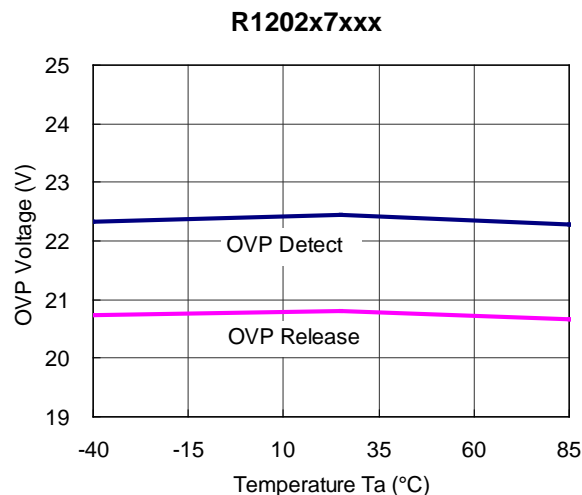

15) Lx Limit Current vs. Temperature

R1202xx1xx

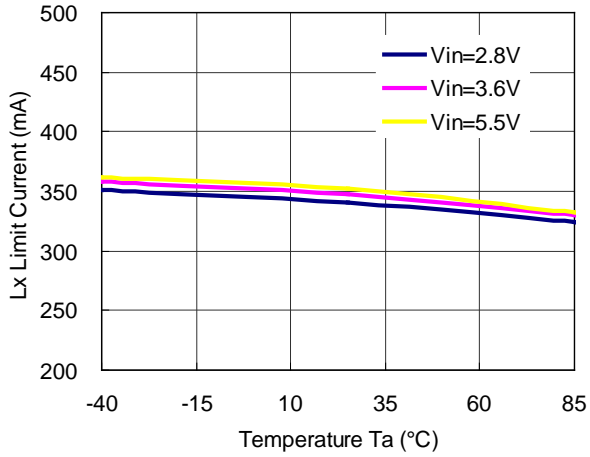

R1202xx2xx

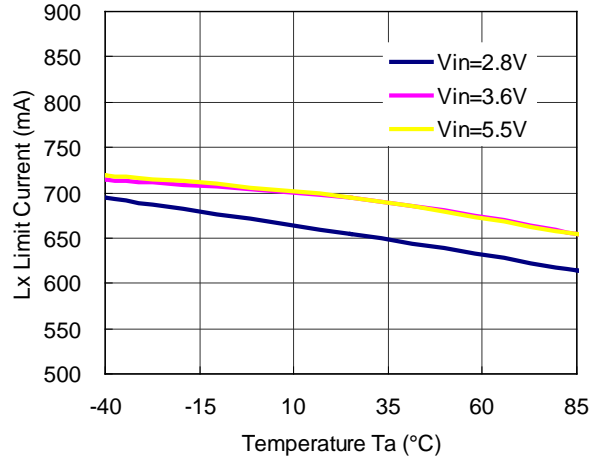

16) Frequency Fosc vs. Temperature

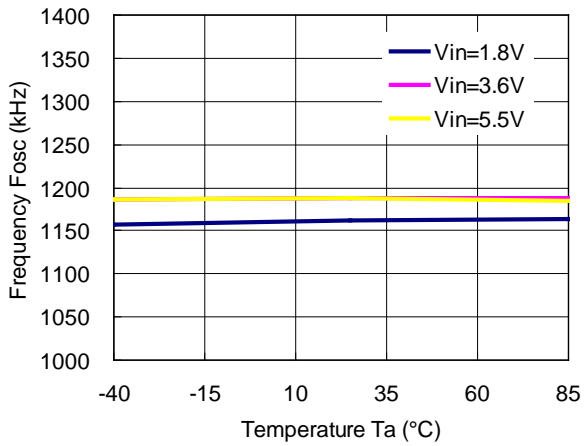

17) MaxDuty vs. Temperature

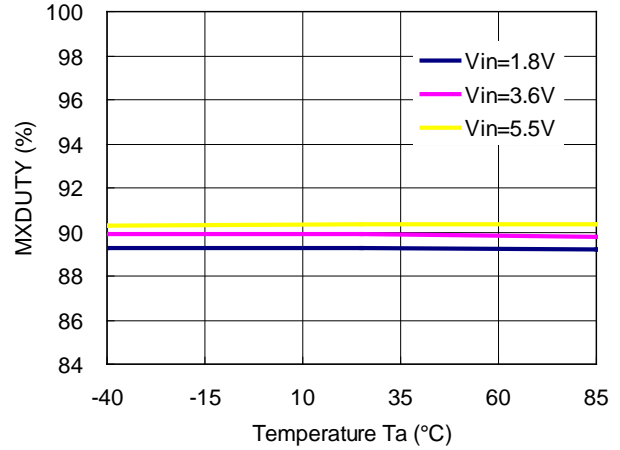

18) Thermal Shutdown Detect / Release Temperature vs. Input Voltage

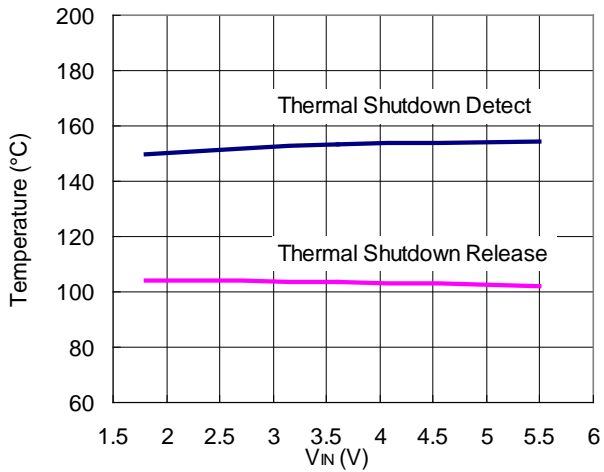

## 19) Inductor Current (output-GND short)

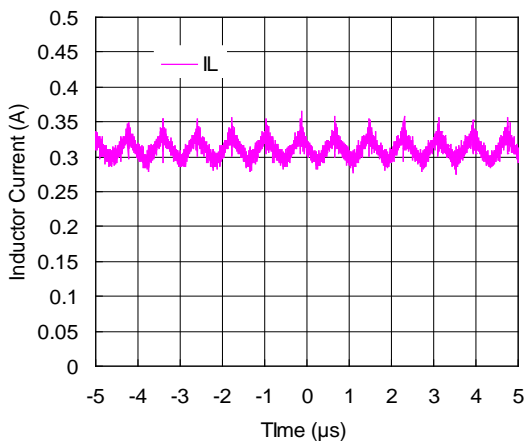
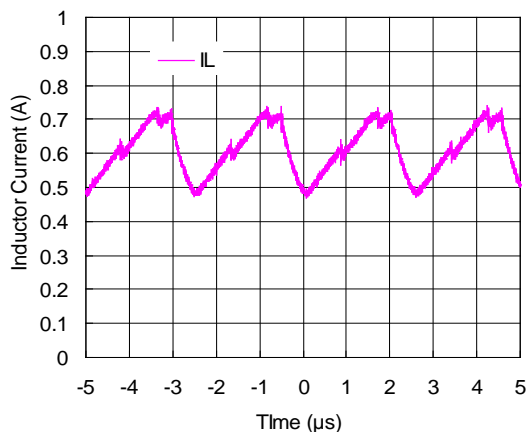
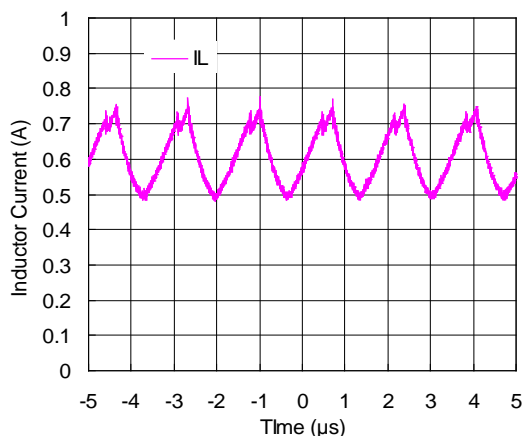
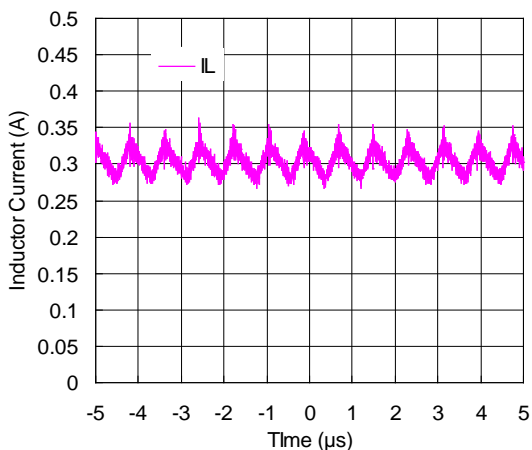
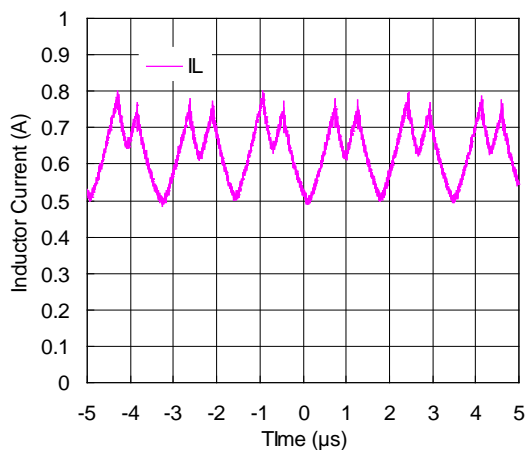
5LED( $V_{IN}=3V$ )  
R1202N713D5LED( $V_{IN}=3V$ )  
R1202N723D5LED( $V_{IN}=3.6V$ )  
R1202N713D5LED( $V_{IN}=3.6V$ )  
R1202N723D5LED( $V_{IN}=4.2V$ )  
R1202N713D5LED( $V_{IN}=4.2V$ )  
R1202N723D



1. The products and the product specifications described in this document are subject to change or discontinuation of production without notice for reasons such as improvement. Therefore, before deciding to use the products, please refer to Ricoh sales representatives for the latest information thereon.
2. The materials in this document may not be copied or otherwise reproduced in whole or in part without prior written consent of Ricoh.
3. Please be sure to take any necessary formalities under relevant laws or regulations before exporting or otherwise taking out of your country the products or the technical information described herein.
4. The technical information described in this document shows typical characteristics of and example application circuits for the products. The release of such information is not to be construed as a warranty of or a grant of license under Ricoh's or any third party's intellectual property rights or any other rights.
5. The products listed in this document are intended and designed for use as general electronic components in standard applications (office equipment, telecommunication equipment, measuring instruments, consumer electronic products, amusement equipment etc.). Those customers intending to use a product in an application requiring extreme quality and reliability, for example, in a highly specific application where the failure or misoperation of the product could result in human injury or death (aircraft, spacevehicle, nuclear reactor control system, traffic control system, automotive and transportation equipment, combustion equipment, safety devices, life support system etc.) should first contact us.
6. We are making our continuous effort to improve the quality and reliability of our products, but semiconductor products are likely to fail with certain probability. In order to prevent any injury to persons or damages to property resulting from such failure, customers should be careful enough to incorporate safety measures in their design, such as redundancy feature, fire containment feature and fail-safe feature. We do not assume any liability or responsibility for any loss or damage arising from misuse or inappropriate use of the products.
7. Anti-radiation design is not implemented in the products described in this document.
8. Please contact Ricoh sales representatives should you have any questions or comments concerning the products or the technical information.



**Ricoh is committed to reducing the environmental loading materials in electrical devices with a view to contributing to the protection of human health and the environment.**

Ricoh has been providing RoHS compliant products since April 1, 2006 and Halogen-free products since April 1, 2012.

**RICOH** RICOH ELECTRONIC DEVICES CO., LTD.

<http://www.e-devices.ricoh.co.jp/en/>

#### Sales & Support Offices

##### **RICOH ELECTRONIC DEVICES CO., LTD.**

**Higashi-Shinagawa Office (International Sales)**  
3-32-3, Higashi-Shinagawa, Shinagawa-ku, Tokyo 140-8655, Japan  
Phone: +81-3-5479-2857 Fax: +81-3-5479-0502

##### **RICOH EUROPE (NETHERLANDS) B.V.**

**Semiconductor Support Centre**  
Prof. W.H. Keesomlaan 1, 1183 DJ Amstelveen, The Netherlands  
Phone: +31-20-5474-309

##### **RICOH INTERNATIONAL B.V. - German Branch**

**Semiconductor Sales and Support Centre**  
Oberrather Strasse 6, 40472 Düsseldorf, Germany  
Phone: +49-211-6546-0

##### **RICOH ELECTRONIC DEVICES KOREA CO., LTD.**

3F, Haesung Bldg, 504, Teheran-ro, Gangnam-gu, Seoul, 135-725, Korea  
Phone: +82-2-2135-5700 Fax: +82-2-2051-5713

##### **RICOH ELECTRONIC DEVICES SHANGHAI CO., LTD.**

Room 403, No.2 Building, No.690 Bibo Road, Pu Dong New District, Shanghai 201203, People's Republic of China  
Phone: +86-21-5027-3200 Fax: +86-21-5027-3299

##### **RICOH ELECTRONIC DEVICES CO., LTD.**

**Taipei office**  
Room 109, 10F-1, No.51, Hengyang Rd., Taipei City, Taiwan (R.O.C.)  
Phone: +886-2-2313-1621/1622 Fax: +886-2-2313-1623

# Mouser Electronics

Authorized Distributor

Click to View Pricing, Inventory, Delivery & Lifecycle Information:

## Ricoh Electronics:

[R1202L711A-TR](#) [R1202L711D-TR](#) [R1202N313A-TR-FE](#) [R1202N323D-TR-FE](#) [R1202L321B-TR](#) [R1202L421A-TR](#)  
[R1202L721A-TR](#) [R1202L721D-TR](#) [R1202L511A-TR](#)

Компания «Океан Электроники» предлагает заключение долгосрочных отношений при поставках импортных электронных компонентов на взаимовыгодных условиях!

Наши преимущества:

- Поставка оригинальных импортных электронных компонентов напрямую с производств Америки, Европы и Азии, а так же с крупнейших складов мира;
- Широкая линейка поставок активных и пассивных импортных электронных компонентов (более 30 млн. наименований);
- Поставка сложных, дефицитных, либо снятых с производства позиций;
- Оперативные сроки поставки под заказ (от 5 рабочих дней);
- Экспресс доставка в любую точку России;
- Помощь Конструкторского Отдела и консультации квалифицированных инженеров;
- Техническая поддержка проекта, помощь в подборе аналогов, поставка прототипов;
- Поставка электронных компонентов под контролем ВП;
- Система менеджмента качества сертифицирована по Международному стандарту ISO 9001;
- При необходимости вся продукция военного и аэрокосмического назначения проходит испытания и сертификацию в лаборатории (по согласованию с заказчиком);
- Поставка специализированных компонентов военного и аэрокосмического уровня качества (Xilinx, Altera, Analog Devices, Intersil, Interpoint, Microsemi, Actel, Aeroflex, Peregrine, VPT, Syfer, Eurofarad, Texas Instruments, MS Kennedy, Miteq, Cobham, E2V, MA-COM, Hittite, Mini-Circuits, General Dynamics и др.);

Компания «Океан Электроники» является официальным дистрибьютором и эксклюзивным представителем в России одного из крупнейших производителей разъемов военного и аэрокосмического назначения «JONHON», а так же официальным дистрибьютором и эксклюзивным представителем в России производителя высокотехнологичных и надежных решений для передачи СВЧ сигналов «FORSTAR».



## JONHON

«JONHON» (основан в 1970 г.)

Разъемы специального, военного и аэрокосмического назначения:

(Применяются в военной, авиационной, аэрокосмической, морской, железнодорожной, горно- и нефтедобывающей отраслях промышленности)

«FORSTAR» (основан в 1998 г.)

ВЧ соединители, коаксиальные кабели, кабельные сборки и микроволновые компоненты:

(Применяются в телекоммуникациях гражданского и специального назначения, в средствах связи, РЛС, а так же военной, авиационной и аэрокосмической отраслях промышленности).



Телефон: 8 (812) 309-75-97 (многоканальный)

Факс: 8 (812) 320-03-32

Электронная почта: [ocean@oceanchips.ru](mailto:ocean@oceanchips.ru)

Web: <http://oceanchips.ru/>

Адрес: 198099, г. Санкт-Петербург, ул. Калинина, д. 2, корп. 4, лит. А