

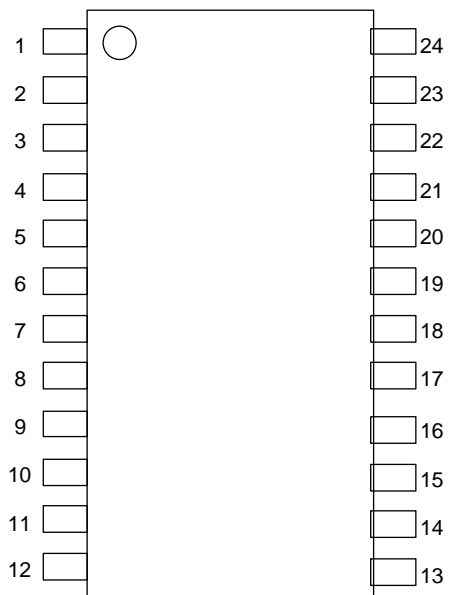

# NJM2706

## ■ PIN CONFIGURATION



- |               |             |
|---------------|-------------|
| 1. LPF        | 13. V+      |
| 2. MIN        | 14. VREFOUT |
| 3. MOUT       | 15. VREFIN  |
| 4. Ca         | 16. SW1     |
| 5. Cr         | 17. SW2     |
| 6. BASSFIL1   | 18. ealaFIL |
| 7. BASSFIL2   | 19. HFFILL  |
| 8. BASSVRIN   | 20. HFFILR  |
| 9. BASSVROUT  | 21. ROUT    |
| 10. ealaVRIN  | 22. LOUT    |
| 11. ealaVROUT | 23. RIN     |
| 12. GND       | 24. LIN     |

## ■ABSOLUTE MAXIMUM RATING (Ta=25°C)

PARAMETER	SYMBOL	RATINGS	UNIT
Supply Voltage	V <sup>+</sup>	15	V
Power Dissipation	P <sub>D</sub>	(SSOP24) 600	mW
Operating Temperature Range	T <sub>opr</sub>	-40 to +85	°C
Storage Temperature Range	T <sub>stg</sub>	-40 to +125	°C

## ■OPERATING VOLTAGE

PARAMETER	SYMBOL	TEST CONDITION	MIN	TYP	MAX	UNIT
Operating Voltage	V <sup>+</sup>	-	4.7	12.0	13.0	V

## ■ELECTRICAL CHARACTERISTICS (Ta=25°C, V<sup>+</sup>=12V unless otherwise specified)

PARAMETER	SYMBOL	TEST CONDITION						MIN	TYP	MAX	UNIT	
		INPUT		OUT PUT	MODE	eala VR	Bass VR					
		L	R									
Operating Current	I <sub>cc</sub>	No Signal	0	0	-	Bypass	-	-	-	15.4	23.0	mA
			0	0	-	Bass	MAX	-	-	15.4	23.0	
Reference Voltage	V <sub>ref</sub>	No Signal	0	0	-	-	-	-	5.8	6.0	6.2	V

## ●AC CHARACTERISTICS (Ta=25°C, V<sup>+</sup>=12V, V<sub>IN</sub>=-20dBV(100mVrms) unless otherwise specified)

PARAMETER	SYMBOL	TEST CONDITION						MIN	TYP	MAX	UNIT	
		INPUT		OUT PUT	MODE	eala VR	Bass VR					
		L	R									
Maximum Input Voltage	V <sub>IM</sub>	f=1kHz THD=3%	V <sub>IN</sub>	-	L	Bypass	-	-	10.0 (32)	12.0 (40)	-	dBV (Vrms)
		f=100Hz THD=3%	V <sub>IN</sub>	V <sub>IN</sub>	*1	Bass	MAX	-	-	6.0 (20)	-	
		f=1kHz THD=3%	V <sub>IN</sub>	-	L	eala	-	MAX	-	7.9 (25)	-	
		f=10kHz THD=3%	V <sub>IN</sub>	-	L	eala Bass	MAX	MAX	7.8 (25)	9.8 (31)	-	
		f=100Hz THD=3%	V <sub>IN</sub>	-	L	eala Bass	MAX	MAX	3.4 (15)	5.4 (19)	-	
Output Noise	V <sub>NO</sub>	R <sub>g</sub> =0Ω A-Weighted	0	0	L	Bypass	-	-	-	-110 (3)	-100 (10)	dBV (μVrms)
		R <sub>g</sub> =0Ω A-Weighted	0	0	L	Bass	MAX	-	-	-98 (13)	-	
		R <sub>g</sub> =0Ω A-Weighted	0	0	L	eala	-	MAX	-	-100 (10)	-	
		R <sub>g</sub> =0Ω A-Weighted	0	0	L	eala Bass	MAX	MAX	-	-97 (14)	-92 (25)	
Total Harmonic Distortion	THD	f=1kHz	V <sub>IN</sub>	-	L	Bypass	-	-	-	0.005	0.01	%
		f=100Hz	V <sub>IN</sub>	V <sub>IN</sub>	L	Bass	MAX	-	-	0.05	-	
		f=1kHz	V <sub>IN</sub>	-	L	eala	-	MAX	-	0.05	-	
		f=1kHz	V <sub>IN</sub>	-	L	eala Bass	MAX	MAX	-	0.05	0.5	

\*1:BASSVR2OUT

# NJM2706

## ●AC CHARACTERISTICS (Ta=25°C, V<sup>+</sup>=12V, V<sub>IN</sub>=-20dBV(100mVrms) unless otherwise specified)

PARAMETER	SYMBOL	TEST CONDITION							MIN	TYP	MAX	UNIT
		INPUT		OUT PUT	MODE	eala VR	Bass VR					
		L	R									
Bypass Gain	G <sub>VBY</sub>	f=1kHz	V <sub>IN</sub> -	- V <sub>IN</sub>	L R	Bypass	-	-	-1.0	0.0	1.0	dB
eala Gain	G <sub>eala</sub>	f=100Hz	V <sub>IN</sub> V <sub>IN</sub>	V <sub>IN</sub> V <sub>IN</sub>	L R	Bass	MAX	-	4.4	6.4	8.4	dB
		f=100Hz	V <sub>IN</sub> V <sub>IN</sub>	V <sub>IN</sub> V <sub>IN</sub>	L R	Bass	MIN	-	-2.0	0.0	2.0	
		f=1kHz	V <sub>IN</sub> -	- V <sub>IN</sub>	L R	eala	-	MAX	2.1	4.1	6.1	
		f=1kHz	V <sub>IN</sub> -	- V <sub>IN</sub>	L R	eala	-	MIN	-2.0	0.0	2.0	
		f=100Hz	V <sub>IN</sub> -	- V <sub>IN</sub>	L R	eala Bass	MAX	MAX	5.9	7.9	9.9	
		f=10kHz	V <sub>IN</sub> -	- V <sub>IN</sub>	L R	eala Bass	MAX	MAX	0.0	2.0	4.0	

## ●CONTROL CHARACTERISTICS (Ta=25°C, V<sup>+</sup>=12V, unless otherwise specified)

PARAMETER	SYMBOL	TEST CONDITION	MIN	TYP	MAX	UNIT
MODE Select Control Voltage	V <sub>MODE</sub>	V <sub>IN</sub> =High Level	2.0	-	V <sup>+</sup>	V
		V <sub>IN</sub> =Low Level	0.0	-	0.7	

## ■SWITCH FUNCTION

MODE	SW2	SW1	NOTES
Bypass	L	L	Input Through
eala	L	H	3D Surround mode
Bass	H	L	Bass Enhanced mode
eala Bass	H	H	3D Surround and Bass Enhanced mode

## ■ TERMINAL DESCRIPTION

No.	SYMBOL	FUNCTION	EQUIVALENT CIRCUIT	VOLTAGE
1	LPF	Capacitor terminal for LPF		V+/2
2	MIN	Monaural Amplifier Input		V+/2
3	MOUT	Monaural Amplifier Output		V+/2
4 5	Ca Cr	Capacitor Terminal for Attack Time Constant Capacitor Terminal for Release Time Constant		0V
6	BASSFIL1	BASS Filter Terminal 1		0V

# NJM2706

## ■ TERMINAL DESCRIPTION

No.	SYMBOL	FUNCTION	EQUIVALENT CIRCUIT	VOLTAGE
7 21 22	BASSFIL2 ROUT LOUT	BASS Filter Terminal 2 Rch Output Lch Output		V+/2
8	BASSVRIN	BASS Effect Adjust Terminal		V+/2
9	BASSVROUT	BASS Effect Adjust Terminal		V+/2
10	ealaVRIN	eala Effect Adjust Terminal		V+/2
11	ealaVROUT	eala Effect Adjust Terminal		V+/2

## ■ TERMINAL DESCRIPTION

No.	SYMBOL	FUNCTION	EQUIVALENT CIRCUIT	VOLTAGE
12	GND	GND Terminal	—————	0V
13	V+	Power Supply Terminal	—————	V+
14	VREFOUT	Reference Voltage Output		V+/2
15	VREFIN	Reference Voltage Input		V+/2
16 17	SW1 SW2	Mode Switch 1 Mode Switch 2		0V

# NJM2706

## ■ TERMINAL DESCRIPTION

No.	SYMBOL	FUNCTION	EQUIVALENT CIRCUIT	VOLTAGE
18	ealaFIL	eala Filter Terminal		V+/2
19 20	HFFILL HFFILR	High Frequency Filter for Lch High Frequency Filter for Rch		V+/2
23 24	RIN LIN	Rch Input Lch Input		V+/2



## APPLICATION CIRCUIT

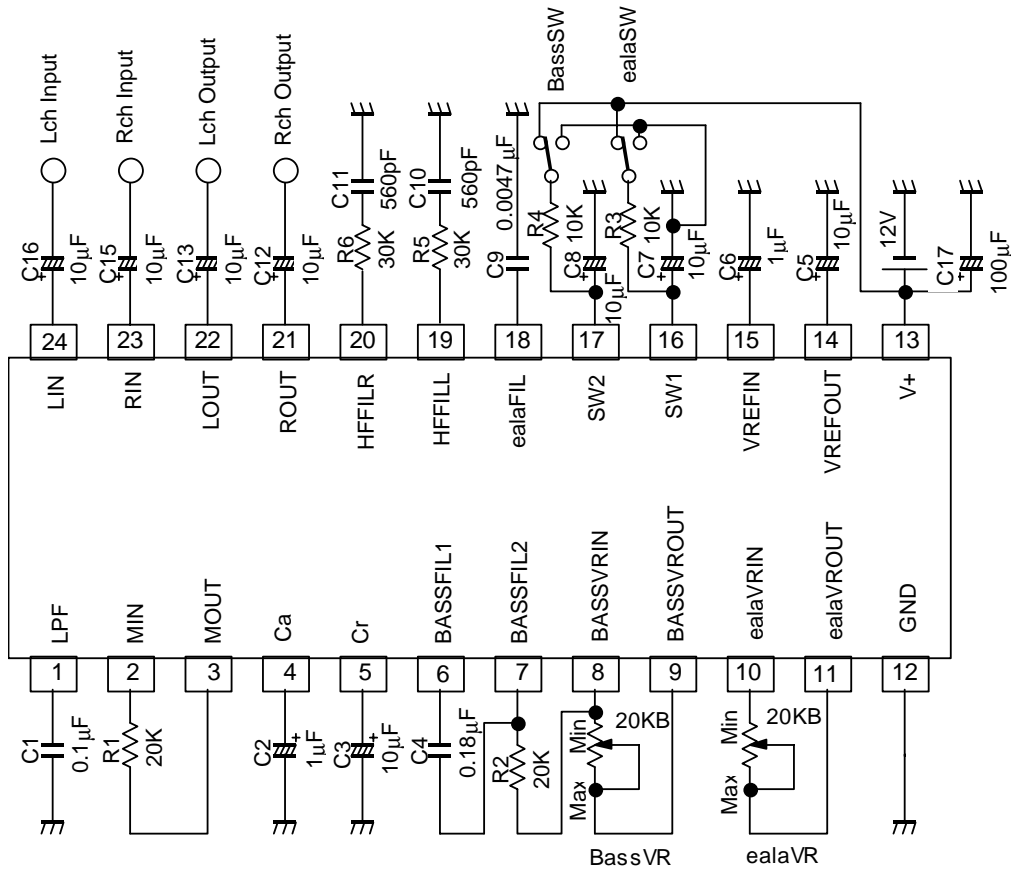

## APPLICATION NOTE

### 1. Fine-Tuning the ealaBASS

The NJM2706 has quite sophisticated NJRC's original dynamic bass-boost technology. Both of the level and the frequency for bass-boost moves automatically corresponding to the input signal level. This dynamic filtering action prevents the signals over boosted, and provides less distortion and wide dynamic range bass-boost processing.

In addition, if you want to fine-tune the bass-boost effect for your system, you can modify the bass-boost effect by changing the external parts value as described below.

#### 1-1. Modify the Boost Center Frequency

This plot shows the frequency response for NJM2706 ealaBASS.

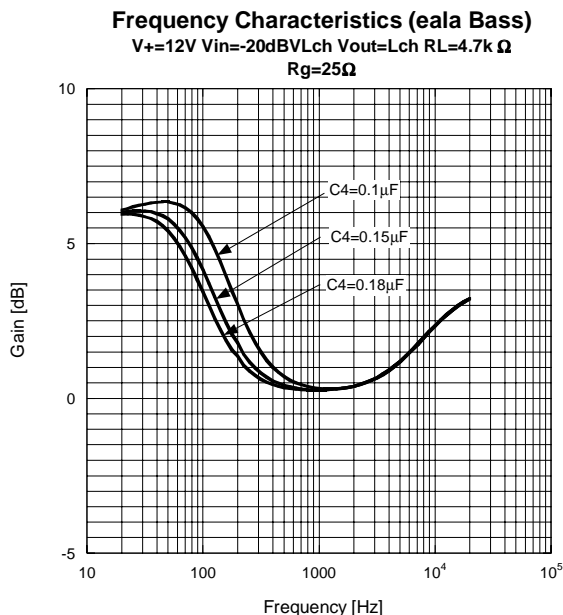

The Boost Center Frequency can be adjusted by changing the value for the external capacitor, C4. If your speaker system has more than 100Hz of  $f_0$  (= Lower Frequency Response Range), or, if you would like to get more powerful bass-boost effect than the typical settings shown on the page 9, increasing the Boost Center Frequency higher could be a good idea. We strongly recommend you to determine the actual capacitance value by testing and examinations on your actual application.

#### 1-2. Modification for the LPF Cut-off Frequency $f_{CL}$

This picture shows the equivalent circuit for NJM2706's LPF.

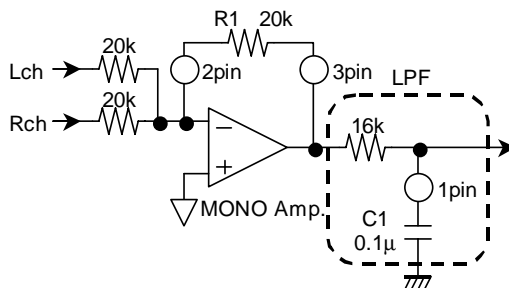

The LPF Cut-off Frequency  $f_{CL}$  is given by the following equation:

$$f_{CL} = \frac{1}{2\pi CR} = \frac{1}{2\pi C1 \times 16k}$$

Set the  $f_{CL}$  as same as the Boost Center Frequency, which is determined as above (The Boost Center Frequency = the frequency of which the gain is +3dB). In the typical application circuit shown on the page 9, the LPF Cut-off Frequency  $f_{CL}$  is set to 100Hz.

## REFERENCE VALUE

	Speaker Size		
	Large(f=100Hz) <sup>*)</sup>	Medium(f=150Hz)	Small(f=200Hz)
C1[μF]	0.1	0.068	0.047
C4[μF]	0.18	0.15	0.1

\*) default value

### 1-3. Adjusting the Summing Level for ealaBASS effect to L/R Output Signal

Changing the resistance value connected between the terminal 8 and 9 can modify the Summing Level for the ealaBASS effect to the L/R Output Signal.

### 2. Adjusting the High Frequency Compensation Filter

The NJM2706 has High Frequency Compensation Filter, which can produce well balance between boosted-bass frequency range and treble frequency range. This picture shows the equivalent circuit for the High Frequency Compensation Filter.

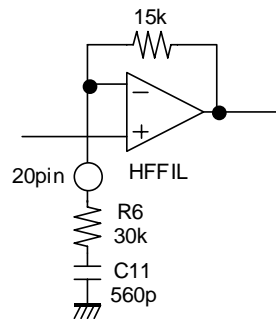

The Cut-off Frequency  $f_{CH}$  and the Voltage Gain  $G_{VH}$  are defined as below:

$$f_{CH} = \frac{1}{2\pi CR} = \frac{1}{2\pi \times C11 \times R6} \quad G_{VH} = 20 \log \frac{R6 + 15k}{R6}$$

In the typical application circuit shown on the page 9, the High Frequency Compensation Filter Cut-off Frequency  $f_{CH}$  is set to 10kHz and Voltage Gain  $G_{VH}$  is set to 3.5dB.

# NJM2706

## 3. Fine-Tuning eala(surround)

Changing the external parts value modifies the eala surround effect as described below.

### 3-1. Adjust the Cut-off frequency

Plot below Shows Voltage gain vs. Frequency.

eala effect depends on C9 value. Changing C9 value controls eala filter cut-off frequency  $f_{CL}$ .

Initial  $f_{CL}$  is 1kHz. After trial listening, decide appropriate C9 value.

Surround frequency becomes higher by smaller value.

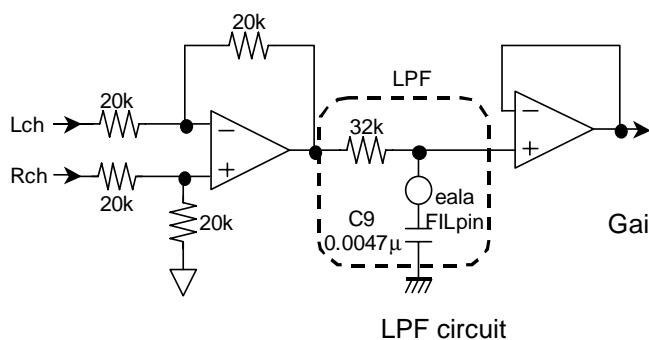

$$f_{CL}(\text{Cut-off Frequency}) = \frac{1}{2\pi CR} = \frac{1}{2\pi C1 \times 32k}$$

Gain vs. Frequency  
 $V_+ = 12V, V_{in} = -10dB, V_{out} = Lch, T_a = 25^\circ C$

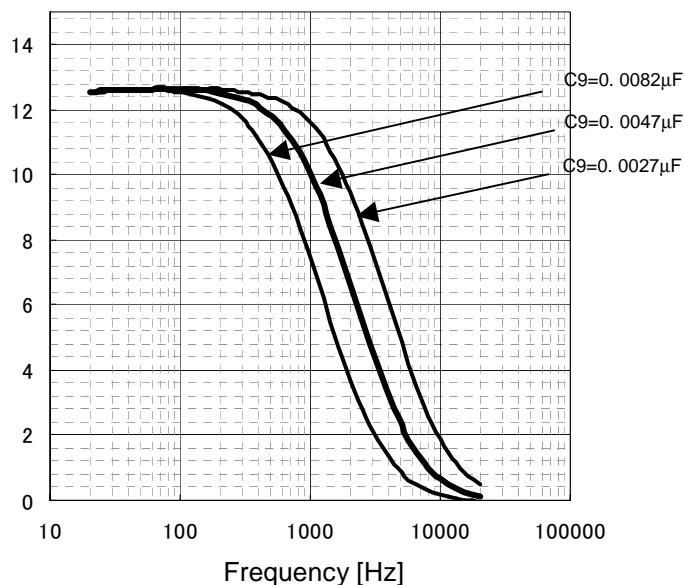

### 3-2 Adjust eala gain

Surround VR value (10pin) controls eala gain.

Typical value is 20kΩ. Surround effect becomes stronger by larger value.

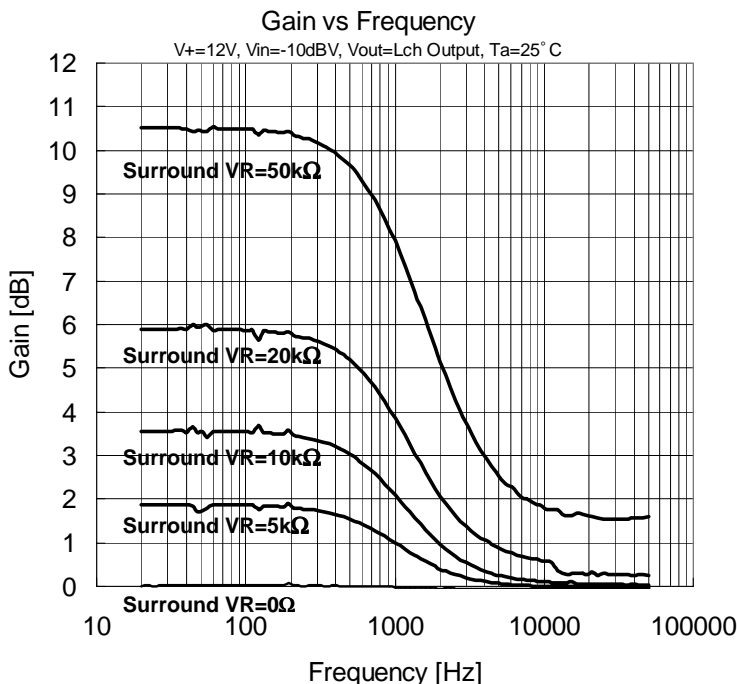

## TYPICAL CHARACTERISTICS

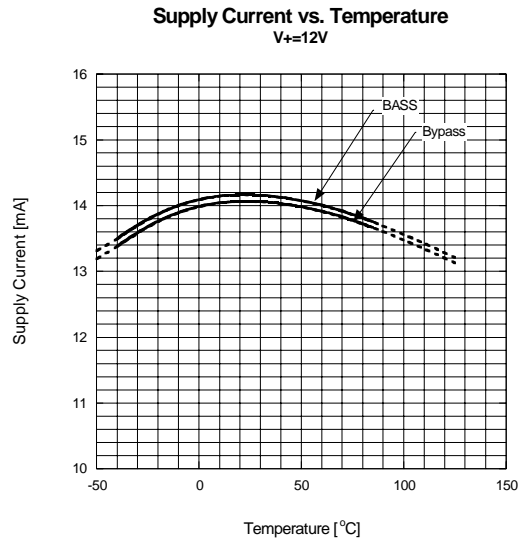
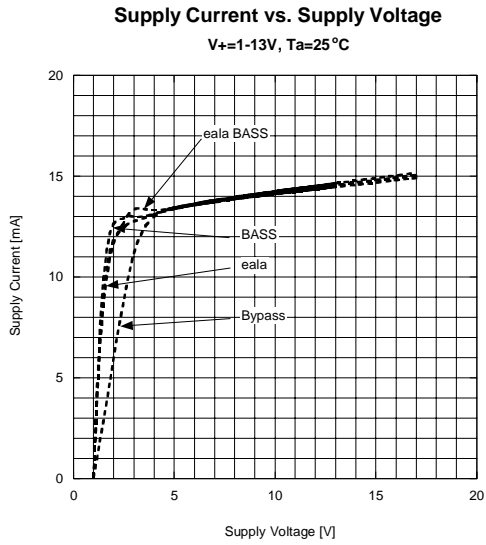

**Maximum Input Voltage vs. Supply Voltage (Bypass)**  
 $V_{in} = Lch, V_{out} = Lch, f = 1kHz, R_L = 4.7k \Omega,$   
 $R_g = 25 \Omega, T_a = 25^\circ C$

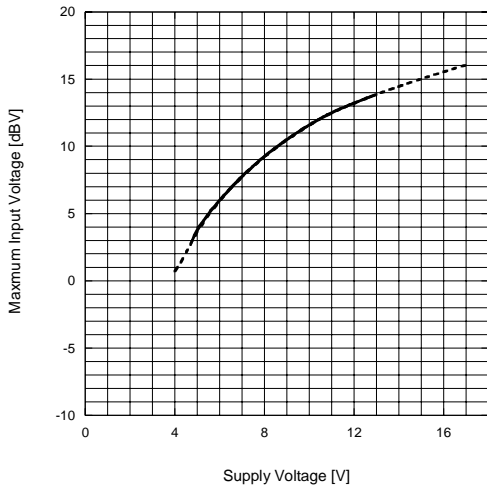

**Maximum Input Voltage vs. Supply Voltage (BASS)**  
 $V_{in} = Lch + Rch, V_{out} = BASSVROUT, f = 100Hz, R_L = 4.7k \Omega,$   
 $R_g = 25 \Omega, T_a = 25^\circ C$

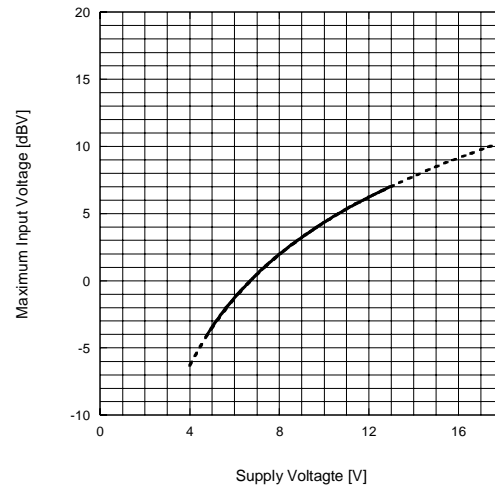

**Maximum Input Voltage vs. Supply Voltage (eala)**  
 $V_{in} = Lch, V_{out} = Lch, f = 1kHz, R_L = 4.7k \Omega,$   
 $R_g = 25 \Omega, T_a = 25^\circ C$

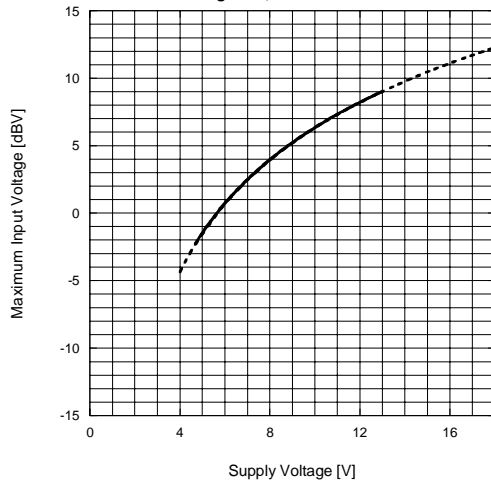

**Maximum Input Voltage (eala BASS)**  
 $V_{in} = Lch, V_{out} = Lch, f = 10kHz, R_L = 4.7k \Omega,$   
 $R_g = 25 \Omega, T_a = 25^\circ C$

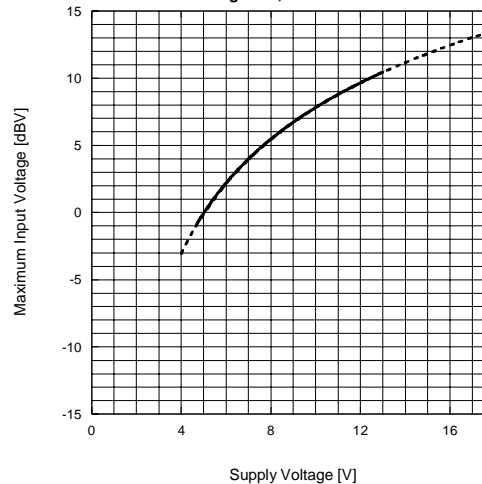

## ■ TYPICAL CHARACTERISTICS

**Maximum Input Voltage vs. Supply Voltage (eala BASS)**  
 $V_{in}=Lch+Rch, V_{out}=Lch, f=100Hz, R_L=4.7k \Omega,$   
 $R_g=25\Omega, T_a=25^\circ C$

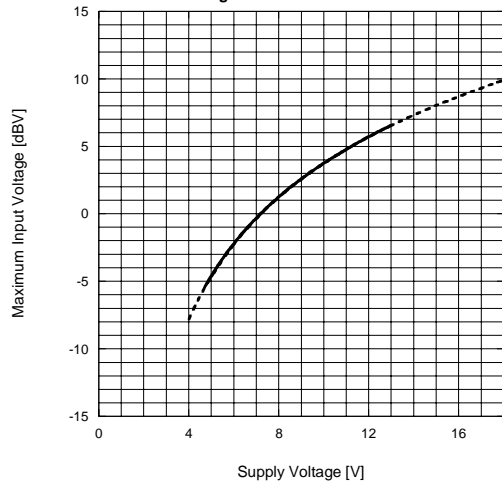

**Output Noise vs. Temperature**  
 $V_+=12V, V_{in}=GND, V_{out}=Lch$

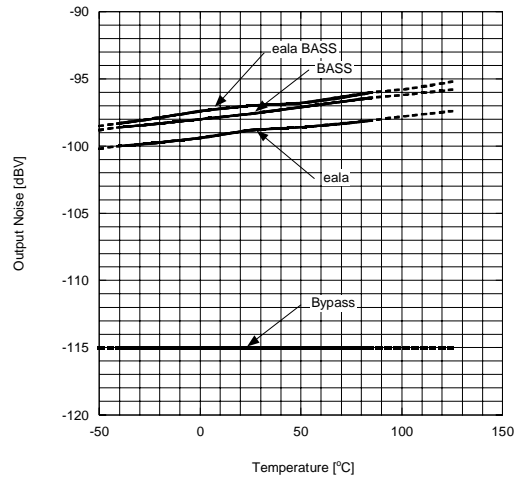

**THD+N vs. Input Voltage (Bypass)**  
 $V_+=12V, V_{in}=Lch, V_{out}=Lch, f=100Hz, R_L=4.7k \Omega,$   
 $R_g=25\Omega, BW=10-80kHz$

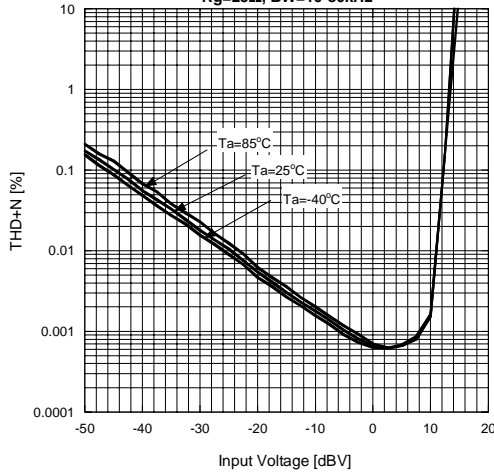

**THD+N vs. Input Voltage (Bypass)**  
 $V_+=12V, V_{in}=Lch, V_{out}=Lch, f=1kHz, R_L=4.7k \Omega,$   
 $R_g=25\Omega, BW=10-80kHz$

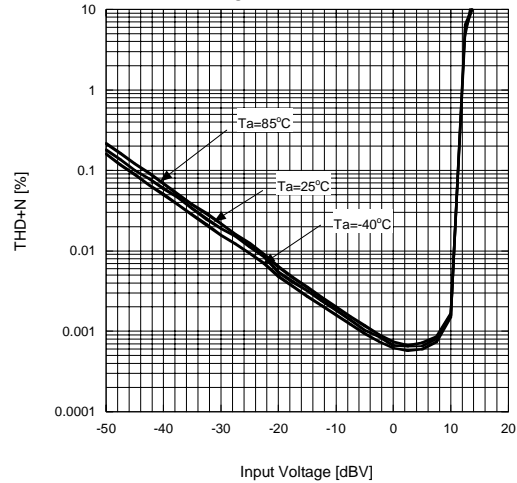

**THD+N vs. Input Voltage (Bypass)**  
 $V_+=12V, V_{in}=Lch, V_{out}=Lch, f=10kHz, R_L=4.7k \Omega,$   
 $R_g=25\Omega, BW=10-80kHz$

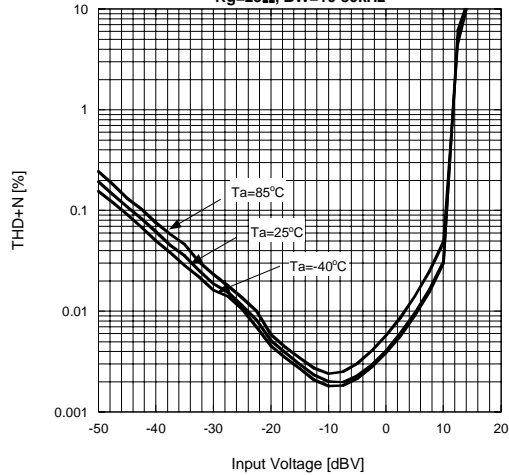

**THD+N vs. Input Voltage (eala)**  
 $V_+=12V, V_{in}=Lch, V_{out}=Lch, f=1kHz, R_L=4.7k \Omega,$   
 $R_g=25\Omega, BW=10-80kHz$

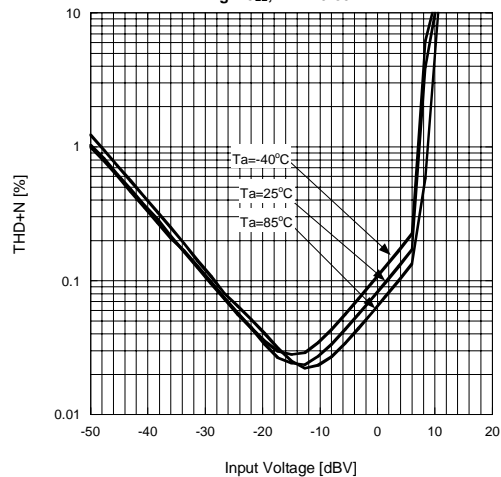

## TYPICAL CHARACTERISTICS

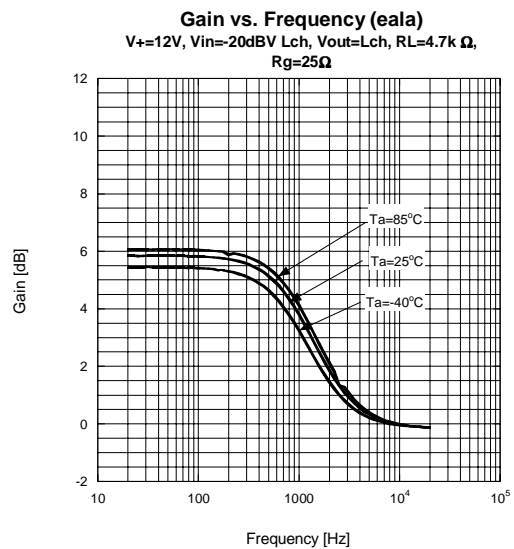
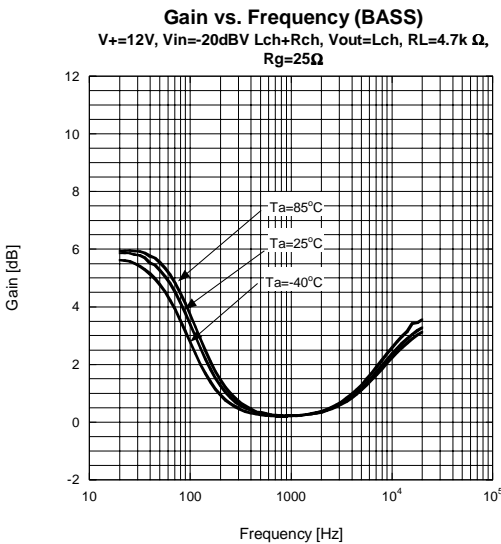
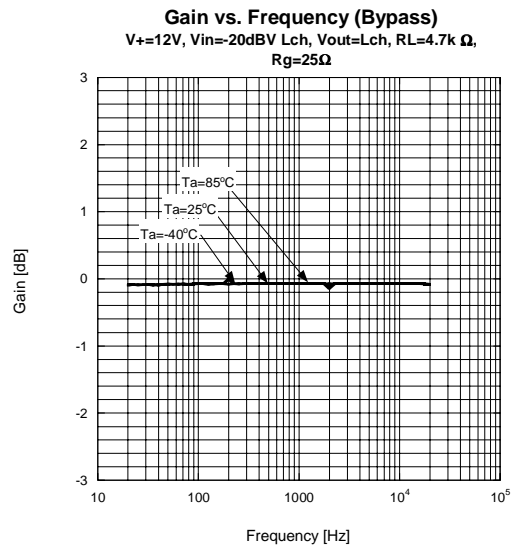
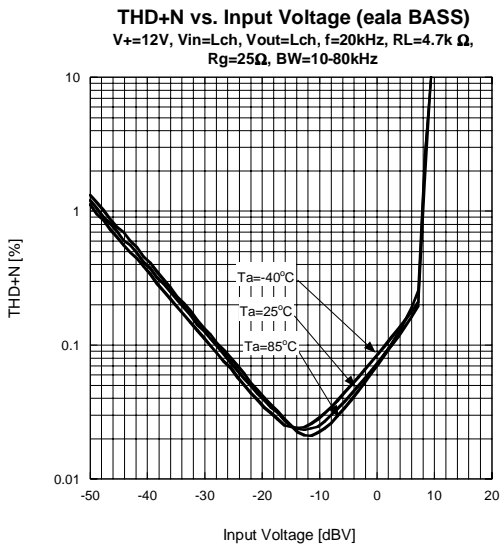
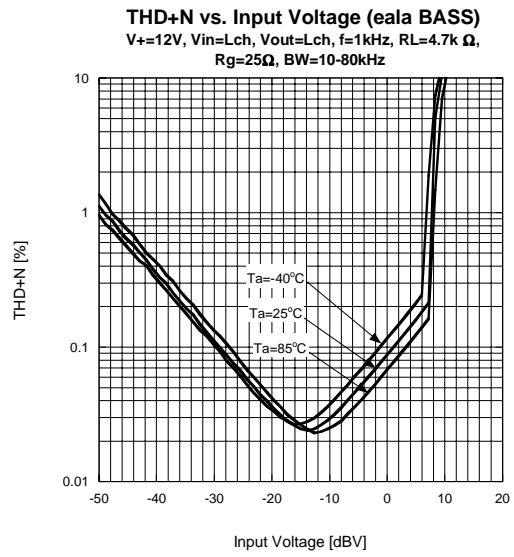
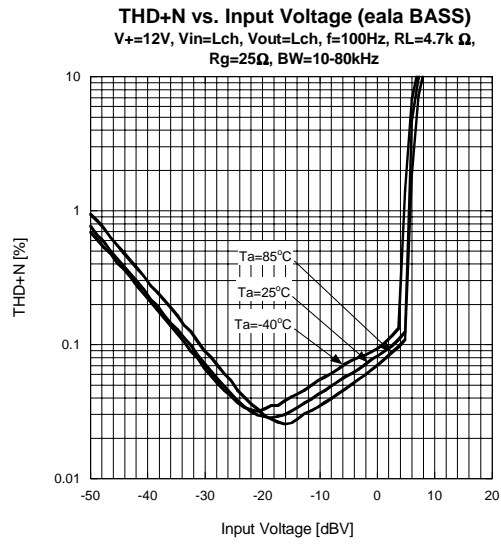

# NJM2706

## ■ TYPICAL CHARACTERISTICS

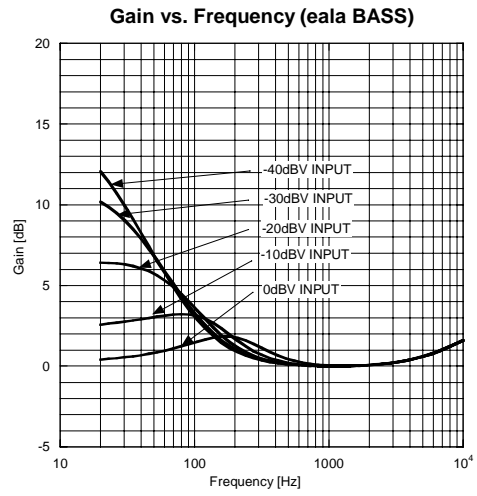
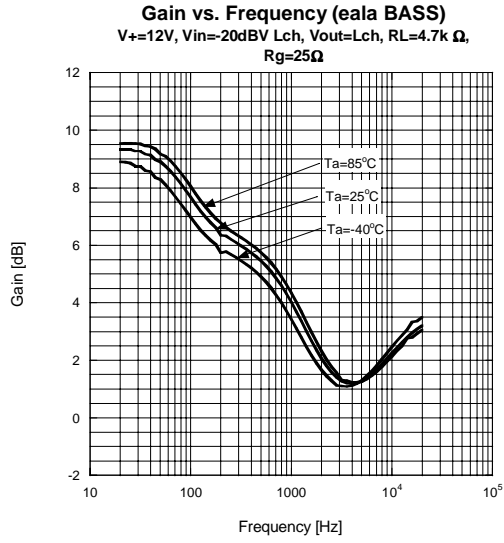

**[CAUTION]**

The specifications on this databook are only given for information, without any guarantee as regards either mistakes or omissions. The application circuits in this databook are described only to show representative usages of the product and not intended for the guarantee or permission of any right including the industrial rights.



# Mouser Electronics

Authorized Distributor

Click to View Pricing, Inventory, Delivery & Lifecycle Information:

[NJR:](#)

[NJM2706L](#) [NJM2706VE1-TE2](#) [NJM2706E2-TE1](#)

Компания «Океан Электроники» предлагает заключение долгосрочных отношений при поставках импортных электронных компонентов на взаимовыгодных условиях!

Наши преимущества:

- Поставка оригинальных импортных электронных компонентов напрямую с производств Америки, Европы и Азии, а так же с крупнейших складов мира;
- Широкая линейка поставок активных и пассивных импортных электронных компонентов (более 30 млн. наименований);
- Поставка сложных, дефицитных, либо снятых с производства позиций;
- Оперативные сроки поставки под заказ (от 5 рабочих дней);
- Экспресс доставка в любую точку России;
- Помощь Конструкторского Отдела и консультации квалифицированных инженеров;
- Техническая поддержка проекта, помощь в подборе аналогов, поставка прототипов;
- Поставка электронных компонентов под контролем ВП;
- Система менеджмента качества сертифицирована по Международному стандарту ISO 9001;
- При необходимости вся продукция военного и аэрокосмического назначения проходит испытания и сертификацию в лаборатории (по согласованию с заказчиком);
- Поставка специализированных компонентов военного и аэрокосмического уровня качества (Xilinx, Altera, Analog Devices, Intersil, Interpoint, Microsemi, Actel, Aeroflex, Peregrine, VPT, Syfer, Eurofarad, Texas Instruments, MS Kennedy, Miteq, Cobham, E2V, MA-COM, Hittite, Mini-Circuits, General Dynamics и др.);

Компания «Океан Электроники» является официальным дистрибьютором и эксклюзивным представителем в России одного из крупнейших производителей разъемов военного и аэрокосмического назначения «JONHON», а так же официальным дистрибьютором и эксклюзивным представителем в России производителя высокотехнологичных и надежных решений для передачи СВЧ сигналов «FORSTAR».



## JONHON

«JONHON» (основан в 1970 г.)

Разъемы специального, военного и аэрокосмического назначения:

(Применяются в военной, авиационной, аэрокосмической, морской, железнодорожной, горно- и нефтедобывающей отраслях промышленности)

«FORSTAR» (основан в 1998 г.)

ВЧ соединители, коаксиальные кабели, кабельные сборки и микроволновые компоненты:

(Применяются в телекоммуникациях гражданского и специального назначения, в средствах связи, РЛС, а так же военной, авиационной и аэрокосмической отраслях промышленности).



Телефон: 8 (812) 309-75-97 (многоканальный)

Факс: 8 (812) 320-03-32

Электронная почта: [ocean@oceanchips.ru](mailto:ocean@oceanchips.ru)

Web: <http://oceanchips.ru/>

Адрес: 198099, г. Санкт-Петербург, ул. Калинина, д. 2, корп. 4, лит. А