

**DPDT Coaxial Switches DC to 6 GHz, DC to 20 GHz, DC to 26.5 GHz, DC to 40 GHz**

Radiall's PLATINUM SERIES switches are optimised to perform at a high level over an extended life span. With outstanding RF performances, and a guaranteed Insertion Loss repeatability of 0.03 dB over a life span of 10 million switching cycles. PLATINUM SERIES switches are perfect for automated test and measurement equipment, as well as signal monitoring devices.

**PART NUMBER SELECTION**

**NEW**

R 593 . 7 3 1 4 . .

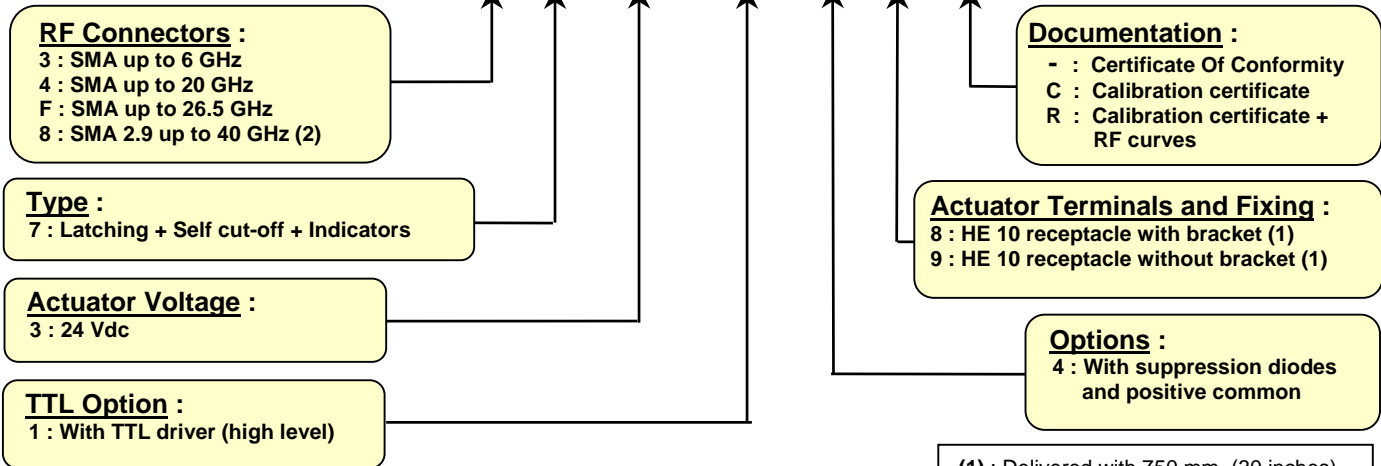

(1) : Delivered with 750 mm (30 inches) ribbon cable + HE10 connector

**PICTURE**



**Note (2)** : Connector SMA 2.9 is equivalent too "K connector®"  
 ® - Registered trademark of Anritsu

In the continual goal to improve our products, we reserve the right to make any modification judged necessary

**RF PERFORMANCES**

PART NUMBER	R59337314-	R59347314-	R593F7314-	R59387314-
Frequency Range GHz	DC to 6	DC to 20	DC to 26.5	DC to 40
Impedance Ohms	50			
Insertion Loss dB (Maximum)	0.2 + 0.025 x frequency (GHz)			
Isolation dB (Minimum)	100	DC to 6 GHz : 100 6 to 12.4 GHz : 90 12.4 to 20 GHz : 80	DC to 6 GHz : 100 6 to 12.4 GHz : 90 12.4 to 20 GHz : 80 20 to 26.5 GHz : 65	DC to 6 GHz : 100 6 to 12.4 GHz : 90 12.4 to 20 GHz : 80 20 to 26.5 GHz : 65 26.5 to 40 GHz : 60
V.S.W.R. (Maximum)	1.20	DC to 6 GHz : 1.20 6 to 12.4 GHz : 1.25 12.4 to 18 GHz : 1.40 18 to 20 GHz : 1.65	DC to 6 GHz : 1.20 6 to 12.4 GHz : 1.25 12.4 to 18 GHz : 1.40 18 to 26.5 GHz : 1.65	DC to 6 GHz : 1.20 6 to 12.4 GHz : 1.25 12.4 to 18 GHz : 1.40 18 to 26.5 GHz : 1.65 26.5 to 40 GHz : 1.70
Repeatability (measured at 25°C)	0.03 dB			0.05 dB

**TYPICAL RF PERFORMANCES**

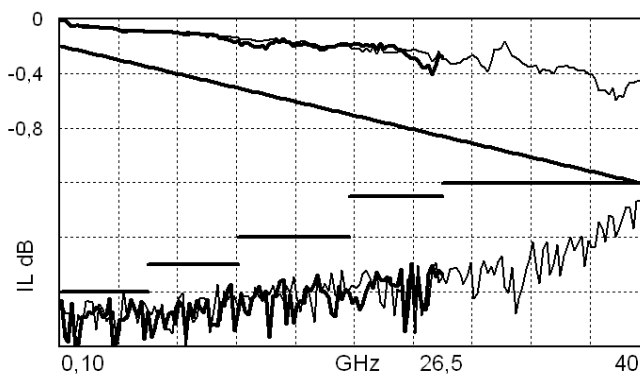

**Insertion Loss and Isolation**

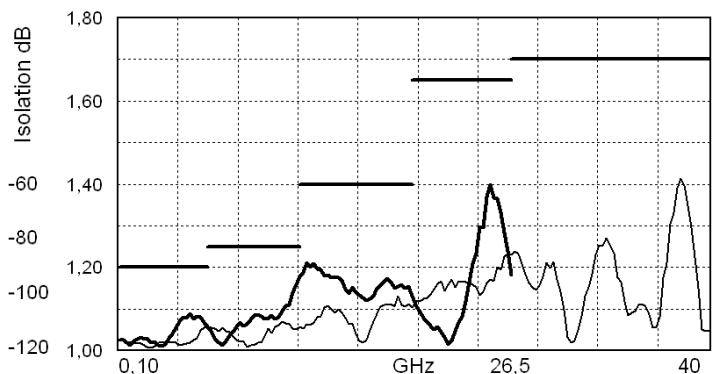

**V.S.W.R.**

: 26.5 GHz model with SMA / 
  : 40 GHz

In the continual goal to improve our products, we reserve the right to make any modification judged necessary

### ADDITIONAL SPECIFICATIONS

<b>Operating mode</b>		<b>Latching</b>	
<b>Nominal operating voltage</b> (across operating temperature) Vdc		<b>24</b> (20 / 32)	
<b>Coil resistance</b> (+/-10%)	Ohms	120	
<b>Nominal operating current at 23°C</b>		200	
<b>Maximum stand-by current</b>		50	
<b>Average power</b>		RF path    Cold switching : see Power Rating Chart on page 6 Hot switching : 1 Watt CW	
<b>TTL input</b>	High Level	3 to 7 V	1.4 mA max at 7 V
	Low Level	0 to 0.8 V	
<b>Indicator specifications</b>		Maximum withstanding voltage :        60V Maximum current capacity :            150 mA Maximum « ON » resistance :        2.5 Ω Minimum « OFF » resistance :        100 MΩ	
<b>Switching time</b> (max)		15	
<b>Life</b> (min) for	SMA	10 million cycles	
	SMA 2.9	5 million cycles	
<b>Connectors</b>		SMA – SMA 2.9	
<b>Actuator terminal</b>		HE10 ribbon receptacle	
<b>Weight</b> (max)	g	110	

### ENVIRONMENTAL SPECIFICATIONS

<b>Operating temperature range</b>	°C	-25 to +75
<b>Storage temperature range</b>	°C	-55 to +85
<b>Temperature cycling</b> (MIL-STD-202 , Method 107D , Cond.A)	°C	-55 to +85 (10 cycles)
<b>Vibration</b> (MIL STD 202 , Method 204D , Cond.D)		10-2000 Hz , 10g        operating
<b>Shock</b> (MIL STD 202 , Method 213B , Cond.C)		50g / 6 ms , ½ sine    operating
<b>Moisture resistance</b> (MIL STD 202 , Method 106E , Cond.E)		65°C, 95% RH, 10 days
<b>Altitude storage</b> (MIL STD 202 , Method 105C , Cond.B)		50,000 feet (15,240 meters)
<b>RFI</b> (MIL STD 1344 , Method 3008 or IEC 61726)		40dB at 20GHz

In the continual goal to improve our products, we reserve the right to make any modification judged necessary

### DRIVING THE SWITCH

There is two positions for a transfer switch. Each RF path can be closed by applying Ground or TTL "High" to the corresponding "drive" pin.

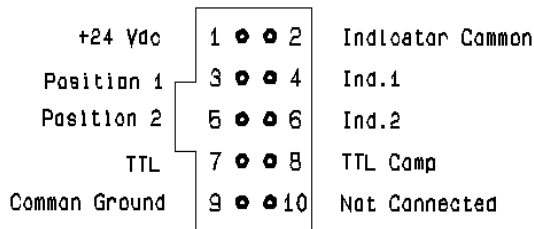

Switch connector

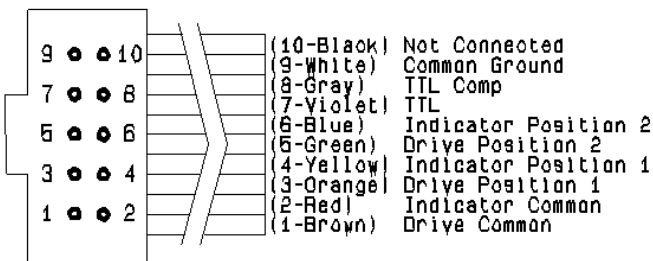

Mating cable connector

### SCHEMATIC DIAGRAM

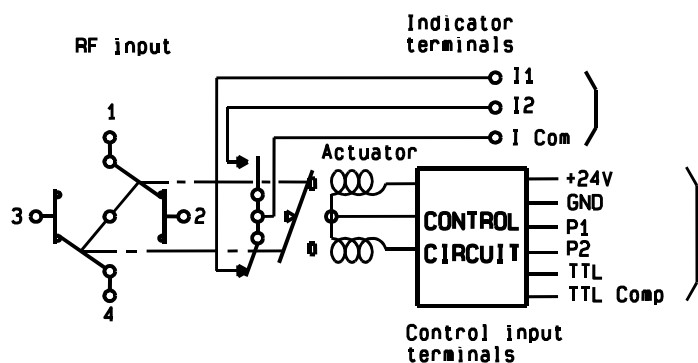

	RF continuity	Indicator
Position 1	1-2 / 3-4	ICom – I1
Position 2	1-3 / 2-4	ICom – I2

#### Standard drive

- Connect pin 9 to ground (See note 1).
- Connect pin 1 to supply (+20 VDC to +32 VDC)
- Select (close) desired RF paths by applying Ground to the corresponding "drive" pin (Ex: apply Ground to pin 3 to close RF path 1-2 and 3-4).
- To select the second path, ensure that unwanted RF path "drive" pin are disconnected from Ground. Apply Ground to the "drive" pin which corresponds to the desired RF paths (Ex: apply Ground to pin 5 to close RF path 1-3 and 2-4).

#### TTL drive (Dual line)

- Connect pin 9 to ground.
- Connect pin 1 to supply (+20 VDC to +32 VDC)
- Select (close) desired RF path by applying TTL "High" to the corresponding "drive" pin (Ex: apply TTL "High" to pin 7 and TTL "Low" to pin 8 to close RF paths position 1).
- To select the second path, ensure that unwanted RF path "drive" pins are in TTL "Low" position. Apply TTL "High" to the "drive" pin which correspond to the desired RF path and TTL "low" to the undesired. (Ex: apply TTL "High" to pin 8 and TTL "Low" to pin 7 to close RF paths position 2).

#### TTL drive (Single line)

- Connect pin 9 to ground.
- Connect pin 1 to supply (+20 VDC to +32 VDC)
- Connect pin 8 to TTL "High".
- Select (close) position 1 by applying TTL "High" to pin 7 (Ex: apply TTL "High" to pin 7 to close RF paths 1-2 and 3-4).
- Select position 2 by applying TTL "Low" to pin 7 (Ex: apply TTL "Low" to pin 7 to close RF paths 1-3 and 2-4).

#### Note 1

Pin 9 does not need to be grounded for the switch to operate in standard drive. If pin 9 is not grounded, the position indicators will only function while the appropriate drive has applied. Therefore, if a pulse drive is used and continuous indicator operation is required, pin 9 must be grounded.

In the continual goal to improve our products, we reserve the right to make any modification judged necessary

**ELECTRONIC POSITION INDICATORS**

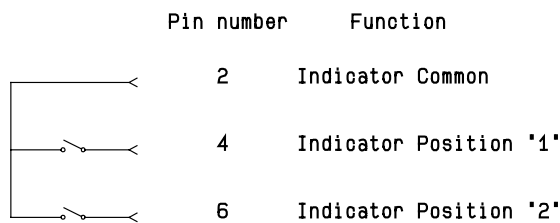

The electronic position indicators utilise photo-MOS transistors which are driven by the mechanical position of the RF paths moving elements. The circuitry consists of a common which can be connected to an output corresponding to selected RF path. The photo-MOS transistors are configured for AC and/or DC operation. The electronic position indicators require the supply (20 to 32 VDC) to be connected to pin 1 and ground connected to pin 9.

**TYPICAL OUTLINE DRAWING**

All dimensions are in millimetres/ inches.

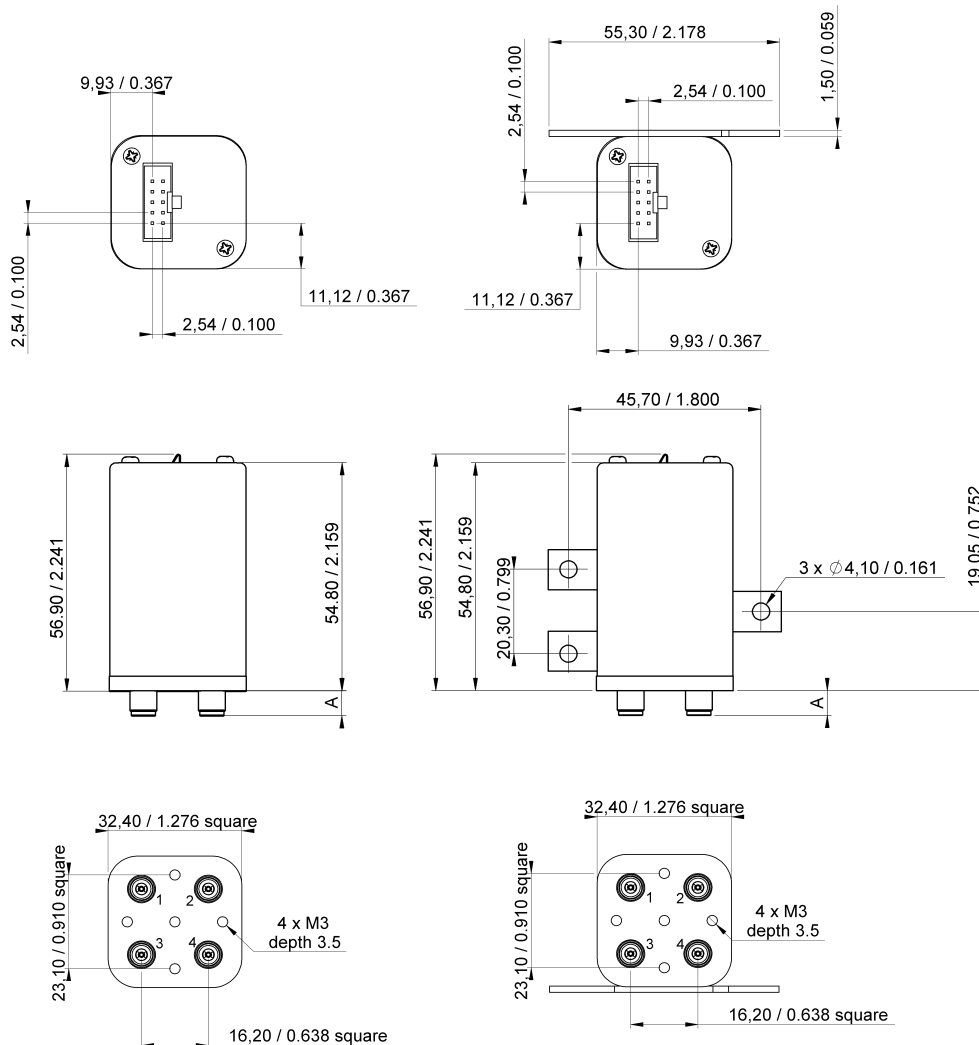

Connectors	SMA	SMA 2.9
A max (mm)	7.4	6.3

In the continual goal to improve our products, we reserve the right to make any modification judged necessary

**POWER RATING CHART**

This graph is based on the following conditions :

- Ambient temperature : + 25°C
- Sea level
- V.S.W.R. : 1 and cold switching

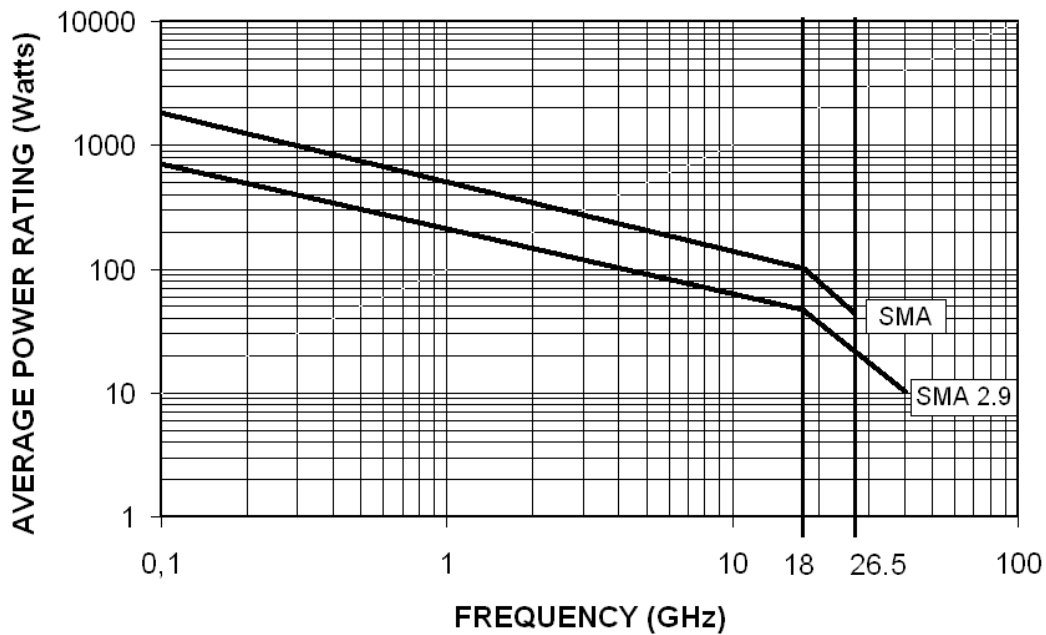

**DERATING FACTOR VERSUS V.S.W.R.**

The average power input must be reduced for load V.S.W.R. above 1.

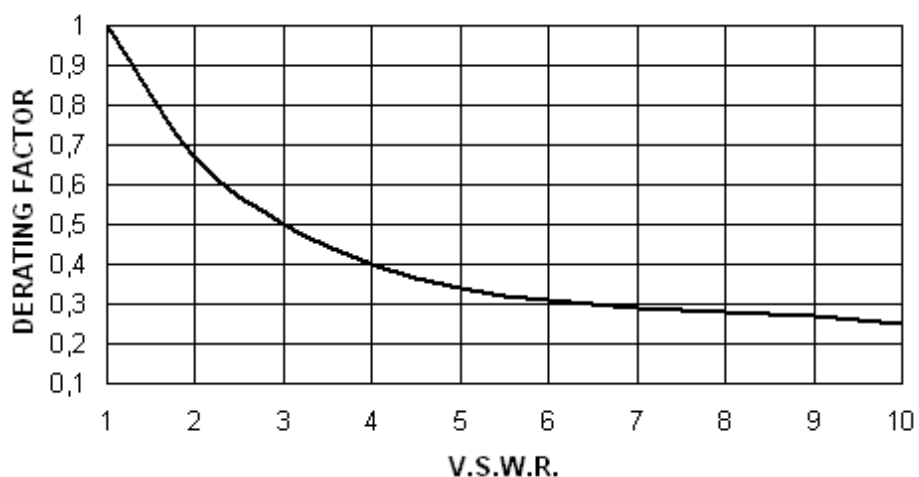

In the continual goal to improve our products, we reserve the right to make any modification judged necessary

Компания «Океан Электроники» предлагает заключение долгосрочных отношений при поставках импортных электронных компонентов на взаимовыгодных условиях!

Наши преимущества:

- Поставка оригинальных импортных электронных компонентов напрямую с производств Америки, Европы и Азии, а так же с крупнейших складов мира;
- Широкая линейка поставок активных и пассивных импортных электронных компонентов (более 30 млн. наименований);
- Поставка сложных, дефицитных, либо снятых с производства позиций;
- Оперативные сроки поставки под заказ (от 5 рабочих дней);
- Экспресс доставка в любую точку России;
- Помощь Конструкторского Отдела и консультации квалифицированных инженеров;
- Техническая поддержка проекта, помощь в подборе аналогов, поставка прототипов;
- Поставка электронных компонентов под контролем ВП;
- Система менеджмента качества сертифицирована по Международному стандарту ISO 9001;
- При необходимости вся продукция военного и аэрокосмического назначения проходит испытания и сертификацию в лаборатории (по согласованию с заказчиком);
- Поставка специализированных компонентов военного и аэрокосмического уровня качества (Xilinx, Altera, Analog Devices, Intersil, Interpoint, Microsemi, Actel, Aeroflex, Peregrine, VPT, Syfer, Eurofarad, Texas Instruments, MS Kennedy, Miteq, Cobham, E2V, MA-COM, Hittite, Mini-Circuits, General Dynamics и др.);

Компания «Океан Электроники» является официальным дистрибьютором и эксклюзивным представителем в России одного из крупнейших производителей разъемов военного и аэрокосмического назначения «JONHON», а так же официальным дистрибьютором и эксклюзивным представителем в России производителя высокотехнологичных и надежных решений для передачи СВЧ сигналов «FORSTAR».



## JONHON

«JONHON» (основан в 1970 г.)

Разъемы специального, военного и аэрокосмического назначения:

(Применяются в военной, авиационной, аэрокосмической, морской, железнодорожной, горно- и нефтедобывающей отраслях промышленности)

«FORSTAR» (основан в 1998 г.)

ВЧ соединители, коаксиальные кабели, кабельные сборки и микроволновые компоненты:

(Применяются в телекоммуникациях гражданского и специального назначения, в средствах связи, РЛС, а так же военной, авиационной и аэрокосмической отраслях промышленности).



Телефон: 8 (812) 309-75-97 (многоканальный)

Факс: 8 (812) 320-03-32

Электронная почта: [ocean@oceanchips.ru](mailto:ocean@oceanchips.ru)

Web: <http://oceanchips.ru/>

Адрес: 198099, г. Санкт-Петербург, ул. Калинина, д. 2, корп. 4, лит. А