



SECTION 6

REED RELAYS FOR PRINTED
CIRCUIT BOARD APPLICATIONS
4 VA TO 100 VA
COAXIAL RELAYS
FOR R. F. SWITCHING



RELAY SERIES

117SIP



L W H
0.290 x 0.280 x 0.750

107DIP

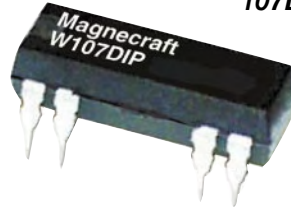

L W H
0.275 X 0.300 X 0.750

171DIP

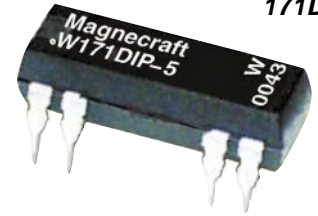

L W H
0.275 X 0.300 X 0.750

FEATURES

- SPST - NO OR NC - EPOXY MOLDED CONSTRUCTION.
- STANDARD 0.1 GRID SPACING.
- AVAILABLE WITH OR WITHOUT SUPPRESSION DIODE ACROSS COIL.

- SPST - NO OR NC - EPOXY MOLDED CONSTRUCTION.
- STANDARD 0.1 GRID SPACING.
- 4 HOOK-UP PINS TO COIL & 4 HOOK-UP PINS TO CONTACTS
- AVAILABLE WITH OPTIONAL ELECTROSTATIC SHIELD

- SPST - NO OR NC - EPOXY MOLDED CONSTRUCTION.
- STANDARD 0.1 GRID SPACING.
- AVAILABLE WITH OR WITHOUT SUPPRESSION DIODE ACROSS COIL.
- AVAILABLE WITH OPTIONAL ELECTROSTATIC SHIELD

CONTACT DATA

CONTACT CONFIGURATION:

SPST-N. O., SPST-N. C.

SPST-N. O., SPST-N. C.

SPST-N. O., SPST-N. C.

CONTACT MATERIAL:

RHODIUM

RHODIUM

RHODIUM

CONTACT RESISTANCE:

100 MILLIOHMS (INITIAL)

100 MILLIOHMS (INITIAL)

100 MILLIOHMS (INITIAL)

MAX. SWITCHING LOAD:

0.5 AMP, 200 VDC @ 10 VA

0.5 AMP, 100 VDC @ 10 VA

0.5 AMP, 100 VDC @ 10 VA

CONTINUOUS CARRY CURRENT:

1.2 AMP

1.5 AMP

1.5 AMP

COIL DATA

STANDARD VOLTAGE DC:

5, 12, 24,

5, 12, 24,

5, 12, 24,

NOMINAL COIL POWER WATTS:

50 - 290 mW MAX.

35 - 290 mW MAX.

35 - 290 mW MAX.

GENERAL DATA

AMBIENT TEMPERATURE OPERATING:

- 45°C TO + 85°C

- 40°C TO + 85°C

- 40°C TO + 85°C

STORAGE:

- 40°C TO + 105°C

- 40°C TO + 105°C

- 40°C TO + 105°C

DIELECTRIC STRENGTH: (COIL TO FRAME)

500 V rms

1000 V rms

1000 V rms

LIFE EXPECTANCY

ELECTRICAL:

50,000,000 OPERATIONS

50,000,000 OPERATIONS

50,000,000 OPERATIONS

MECHANICAL:

100,000,000 OPERATIONS

100,000,000 OPERATIONS

100,000,000 OPERATIONS

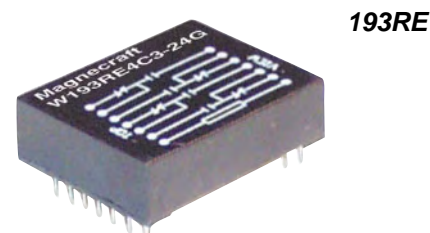
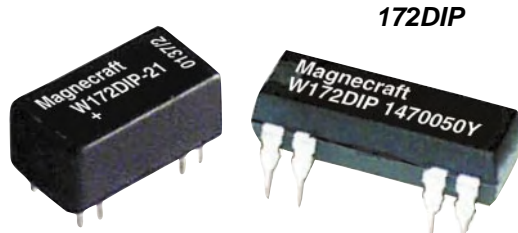
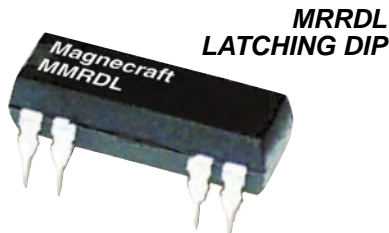

L W H
0.275 X 0.300 X 0.750

L W H
0.275 X 0.300 X 0.750/0.338 X 0.393 X 0.750

L W H
0.355 X 0.4 TO 0.9 X 1.15

- SPST - NO - EPOXY MOLDED CONSTRUCTION
- STANDARD 0.1 GRID SPACING
- DUAL OPERATE & RESET COIL
- MAINTAINS LAST SET CONTACT POSITION WITHOUT THE NEED FOR COIL POWER

- SPDT - EPOXY MOLDED CONSTRUCTION. DPDT - ENCAPSULATED CONSTRUCTION.
- STANDARD 0.1 GRID SPACING.
- AVAILABLE WITH SUPPRESSION DIODE ACROSS COIL.
- AVAILABLE WITH OPTIONAL ELECTROSTATIC SHIELD

- SPDT -NO, SPDT, DPST - NO & DPDT - DUST COVER STANDARD. ENCAPSULATED CONSTRUCTION OPTIONAL
- STANDARD 0.1 GRID OR OPTIONAL 0.15 GRID SPACING.
- UP TO 4PDT OR 6PST CONTACT ARRANGEMENTS.

SPST-N. O.

SPDT, DPDT

1 TO 4PDT, 1 TO 6PST

RHODIUM

RHODIUM

RHODIUM

100 MILLIOHMS (INITIAL)

100 MILLIOHMS (INITIAL)

200 MILLIOHMS (INITIAL)

0.5 AMP, 100 VDC @ 10 VA

SPDT: 0.25 AMP, 100 VDC @ 4 VA
DPDT: 0.5 AMP, 100 VDC @ 10 VA

MAX. SWITCHING
0.5 AMP OR 200 VDC
@ 10 VA

1.5 AMP

SPDT - 0.5 AMP, DPDT - 1.0 AMP

1.5 AMP

5, 12, 24,

5, 12, 24,

12, 24,

35 - 290 mW MAX.

35 - 290 mW MAX.

1030 mW MAX.

- 40°C TO + 85°C

- 40°C TO + 85°C

- 40°C TO + 85°C

- 40°C TO + 105°C

- 40°C TO + 105°C

- 40°C TO + 105°C

1000 V rms

1000 V rms

500 V rms

50,000,000 OPERATIONS
100,000,000 OPERATIONS

50,000,000 OPERATIONS
100,000,000 OPERATIONS

50,000 OPERATIONS
10,000,000 OPERATIONS

RELAY SERIES

134 MPCX
MERCURY
WETTED



102VX & 102HVX



120 COAXIAL



L W H
2.90 X 1.53 X 1.40

L W H
0.65 X 0.76 X 2.67

L W H
1.73 X 0.703 X 1.62

FEATURES

- SPDT & DPDT - DUST COVER STANDARD. ENCAPSULATED CONSTRUCTION OPTIONAL
- STANDARD 0.1 GRID OR OPTIONAL 0.15 SPACING AVAILABLE.
- POSITION SENSITIVE. VERTICAL MOUNTED.

- SPST - NO EPOXY ENCAPSULATED HIGH VOLTAGE REED
- SWITCHING UP TO 10 MA @ 5,000 VDC
5 MA @ 10,000 VDC

- SPDT - METAL CASE 150 WATT SWITCHING UP TO 470 MHz.
- RG58C/U CABLE, 12" LONG STANDARD. 50 OHM IMPEDANCE R.F. SWITCHING CONTACTS

CONTACT DATA

CONTACT CONFIGURATION:

SPDT, DPDT

SPST- N. O.

SPDT

CONTACT MATERIAL:

RHODIUM / MERCURY

TUNGSTEN

SILVER ALLOY GOLD FLASHED

CONTACT RESISTANCE:

100 MILLIOHMS (INITIAL)

200 MILLIOHMS (INITIAL)

50 MILLIOHMS (INITIAL)

MAX. SWITCHING LOAD:

MAX. SWITCHING
1.0 AMP OR 500 VDC @ 50 VA

VX-10 MA @ 5000VDC
HVX-5 MA @ 10,000 VDC

150 WATTS, 85 Vrms

CONTINUOUS
CARRY CURRENT:

30 & 15 MILLIAMPS

150 WATTS

COIL DATA

STANDARD VOLTAGE
DC:

5, 12, 24,

12, 24,

12

NOMINAL COIL POWER
WATTS:

620 mW MAX.

1.5 WATTS MAX.

1.44 WATTS MAX.

GENERAL DATA

AMBIENT TEMPERATURE
OPERATING:

- 37°C TO + 85°C

- 40°C TO + 85°C

- 55°C TO + 65°C

STORAGE:

- 40°C TO + 105°C

- 40°C TO +105°C

- 40°C TO +105°C

DIELECTRIC STRENGTH:
(COIL TO FRAME)

1000 V rms

12000 V rms

1500 V rms

LIFE EXPECTANCY

ELECTRICAL:
MECHANICAL:

40,000 OPERATIONS
10,000,000 OPERATIONS

1,000,000 OPERATIONS
10,000,000 OPERATIONS

5,000,000 OPERATIONS
100,000 OPERATIONS

HOW REED RELAYS WORK

The term reed relay covers dry reed relays and mercury-wetted contact relays, all of which use hermetically sealed reed switches. In both types, the reeds (thin, flat blades) serve multiple functions - as conductor, contacts, springs, and magnetic armatures.

DRY REED RELAYS

Dry reed relays have become an important factor in the relay field. They have the advantage of being hermetically sealed and resistant to atmospheric contamination. They have fast operate and release times and when operated within their rated contact loads, have very long life. A typical dry reed switch capsule is shown in Figure 1.

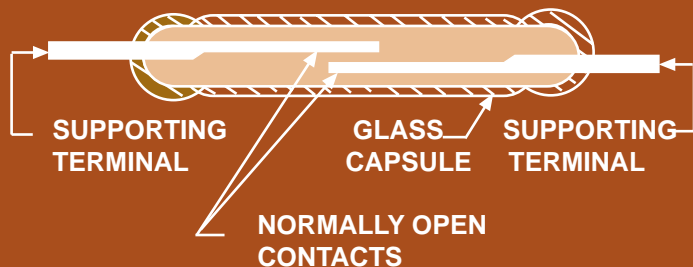

Figure 1. Construction of Switch Capsule of Typical Dry Reed switch (SPST-NO)

In the basic SPST-NO design, two opposing blades are sealed into a narrow glass capsule and overlapped at their free ends. The contact area is plated typically with rhodium to produce a low contact resistance when contacts are drawn together. The capsule is made of glass and filled with a dry inert gas and then sealed. The capsule is surrounded by an electromagnetic coil. When the coil is energized, the normally open contacts are brought together; when the coil voltage is removed, the blades separate by their own spring tension. Some reeds contain permanent magnets for magnetic biasing to achieve normally closed contacts (SPST-NC) or SPDT contact combinations. The current rating, which is dependent upon the size of the blade and the type and amount of plating, may range from low level to 1 amp. Effective contact protection is essential when switching loads other than dry resistive loads.

MERCURY-WETTED CONTACT RELAYS.

Mercury wetted contacts consist of a glass-encapsulated reed with its base immersed in a pool of mercury and the other end capable of moving between one or two stationary contacts. The mercury flows up the reed by capillary action and wets the contact surfaces of the moving end of the reed as well as the contact surfaces of the stationary contacts. A mercury to mercury contact is maintained in the closed position. The capsule is surrounded by an electromagnetic coil and operates in the same manner as a dry reed.

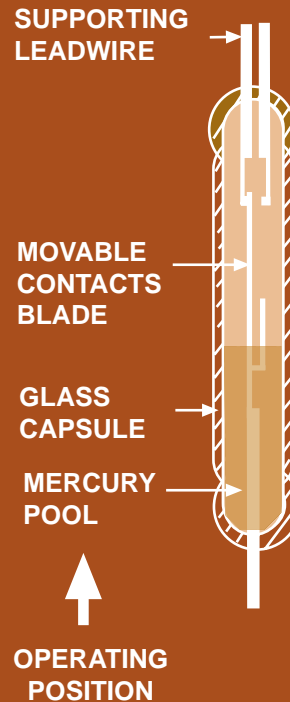

Figure 2. Miniature Mercury wetted contacts switch (SPST)

Mercury wetted contacts are fast in operation and have relatively good load carrying capacity and long life. The mercury films are reestablished at each contact closure and contact erosion is eliminated. The mercury films are stretchable, there is no contact bounce and because it is a mercury contact, the contact resistance is very low and ideal for low level switching applications. The disadvantages of this type of reed relay are the freezing point of mercury (-38°C), poor resistance to shock and vibration and the need to mount the relay in a near vertical position. These relays are used for a variety of switching applications such as found in computers, business machines, machine tool control systems, and laboratory instruments.

CONTACT COMBINATIONS.

The switches used in dry reed relays provide SPST-NO, SPST-NC, SPDT contact combinations.

The SPST-NO corresponds with the basic switch capsule design (Fig.1).

The SPST-NC results from a combination of the SPST-NO switch and a permanent magnet strong enough to pull the contacts closed but able to open when coil voltage is applied to the relay coil.

In typical true SPDT designs, the armature is mechanically tensioned against the normally closed contact, and is moved to the normally open contact upon application of a magnetic field. The SPDT contact combination can also be achieved by joining a SPST-NO switch with an appropriately adjusted SPST-NC switch, and jumping one side of both switches together to form the movable contact system.

Latching contacts, defined as contacts which remain in the position to which they were driven, and stay in that position when coil power is removed from the relay coil.

Latching switches are manufactured by using a SPST-NO contact, and biasing it with a permanent magnetic that is strong enough to hold the contacts closed, but not strong enough to hold the contact closed when coil power is applied to the coil. The switching process is then reversed by simply reversing the relay coil polarity to close the switch, or by employing a second coil with a reverse field.

APPLICATION DATA

MAGNETIC FIELDS

Reed relays in general can be characterized as susceptible to the influences of external magnetic fields. It is important to keep reed relays at a proper distance from each other because of the possibility of magnetic-interaction between them. Proper magnetic shielding must be used to contain stray magnetic fields. When installing reed relays into equipment, one should be aware of the devices within that equipment which can produce magnetic fields. The relays being installed into that equipment should be positioned as far away as possible from any stray magnetic fields and should be shielded to prevent false operations.

ELECTRICAL CHARACTERISTICS

SENSITIVITY:

The input power required to operate dry reed relays is determined by the sensitivity of the particular reed switch used, by the number of switches operated by the coil, by the permanent magnet biasing (if used), and the efficiency of the coil and the effectiveness of its coupling to the blades. Minimum input required to effect closure ranges from the very low milliwatt level for a single sensitive capsule to several watts for multipole relays.

OPERATE TIME:

The coil time constant, overdrive on the coil, and the characteristics of the reed switch determine operate time. With the maximum overdrive voltage applied to the coil, reed relays will operate in approximately the 200 microsecond range. When driven at rated coil voltage, usually the relays will operate at about one millisecond.

RELEASE TIME:

With the coil unsuppressed, dry reed switch contacts release in a fraction of a millisecond. SPST-NO contacts will open in as little as 50 microseconds. Magnetically biased SPST-NC and SPDT switches reclose from 100 microseconds to 1 millisecond respectively. If the relay coil is suppressed, release times are increased. Diode suppression can delay release times for several milliseconds, depending on coil characteristics, coil voltage, and reed release characteristics.

CONTACT BOUNCE

Dry reed contacts bounce on closure as with any other hard contact relay. The duration of bounce on a Dry reed switch is typically very short, and is in part dependent on drive level. In some of the faster devices, the sum of the operate time and bounce is relatively constant. As drive is increased, the operate time decreases with bounce time increasing. The normally closed contacts of a SPDT switch bounce more than the normally open contacts. Magnetically biased SPST-NC contacts exhibit essentially the same bounce characteristics as SPST-NO switches.

CONTACT RESISTANCE

The reeds (blades) in a dry reed switch are made of magnetic material which has a high volume resistivity, terminal-to-terminal resistance is somewhat higher than in some other types of relays. Typical specification limits for initial resistance of a SPST-NO reed relay is 0.200 ohms max (200 milliohms).

INSULATION RESISTANCE

A dry reed switch made in a properly controlled internal atmosphere will have an insulation resistance of 10^{12} to 10^{14} ohms or greater. When it is assembled into a relay, parallel insulation paths reduce this to typical values of 10^8 ohms. Depending on the particular manner of relay construction, exposure to high humidity or contaminating environments can appreciably lower final insulation resistance.

CAPACITANCE

Reed capsules typically have low terminal-to-terminal capacitance. However, in the typical relay structure where the switch is surrounded by a coil, capacitance from each reed to the coil act to increase capacitance many times. If the increased capacitance is objectionable, it can be reduced by placing a grounded electrostatic shield between the switch and coil.

DIELECTRIC WITHSTAND VOLTAGE

With the exception of the High-Voltage dry reed switches (capsules that are pressurized or evacuated), the dielectric strength limitation of relays is determined by the ampere turn sensitivity of the switches used. A typical limit is 200 VAC. The dielectric withstand voltage between switch and coil terminals is typically 500 VAC.



THERMAL EMF

Since thermally generated voltages result from thermal gradients within the relay assembly, relays built to minimize this effect often use sensitive switches to reduce required coil power, and thermally conductive materials to reduce temperature gradients. Latching relays, which may be operated by a short duration pulse, are often used if the operational rate is not changed for longer periods of time because coil power is not required to keep the relay in the on or off position after the initial turn on or turn off pulse.

NOISE

Noise is defined as a voltage appearing between terminals of a switch for a few milliseconds following closure of the contacts. It occurs because the reeds (blades) are moving in a magnetic field and because voltages are produced within them by magnetostrictive effects. From an application standpoint, noise is important if the signal switched by the reed is to be used within a few milliseconds immediately following closure of the contacts. When noise is critical in an application, a peak-to-peak limit must be established by measurement techniques, including filters which must be specified for that particular switching application.

ENVIRONMENTAL CHARACTERISTICS

Reed relays are used in essentially the same environments as other types of relays. Factors influencing their ability to function would be temperature extremes beyond specified limits

VIBRATION

The reed switch structure, with so few elements free to move, has a better defined response to vibration than other relay types. With vibration inputs reasonably separated from the resonant frequency, the reed relay will withstand relatively high inputs, 20 g's or more. At resonance of the reeds, the typical device can fail at very low input levels. Typical resonance frequency is 2000 hz.

SHOCK

Dry reed relays will withstand relatively high levels of shock. SPST-NO contacts are usually rated to pass 30 to 50 g's, 11 milliseconds, half sign wave shock, without false operation of contacts. Switches exposed to a magnetic field that keep the contacts in a closed position, such as in the biased latching form, demonstrate somewhat lower resistance to shock. Normally closed contacts of mechanically biased SPDT switches may also fail at lower shock levels.

TEMPERATURE

Differential expansion or contraction of reed switches and materials used in relay assemblies can lead to fracture of the switches. Reed relays are capable of withstanding temperature cycling or temperature shock over a range of at least -50°C to + 100°C. These limits should be applied to the application to prevent switch failure.

CONTACT PROTECTION

Tungsten lamp, inductive and capacitive discharge load are extremely detrimental to reed switches and reduce life considerably. Illustrated below are typical suppression circuits which are necessary for maximum contact life.



Figure 3

Initial cold filament turn-on current is often 16 times higher than the rated operating current of the lamp. A current limiting resistor in series with the load, or a bleeder resistor across the contacts will suppress the inrush current. The same circuits can be used with capacitive loads, as shown in Figure 3.



Figure 4

DC inductive loads call for either a diode or a thyristor to be placed across the load. These circuits are necessary to protect the contacts when inductive loads are to be switched in a circuit, as shown in Figure 4.

U. S. A.

TELEPHONE: (843)393-5778

FAX: (843)393-4123

WEBSITE: www.magnecraft.com

EMAIL: info@magnecraft.com

EUROPE

TELEPHONE: 4989 / 75080310

FAX: 4989/ 7559344

WEBSITE: www.magnecraft.com

EMAIL: renatesteinback@magnecraft.de



GENERAL SPECIFICATIONS

COIL

| | |
|-------------------|--------------------------------|
| Pull-in Voltage: | 85% of nominal voltage or less |
| Drop Out Voltage: | 10% of nominal voltage or more |
| Max. Voltage: | 110% of nominal voltage |
| Resistance: | ±10% measured @ 25°C |
| Coil Power: | See chart |
| Duty: | Continuous |

CONTACTS

| | |
|---------------------|--|
| Contact Material: | Rhodium |
| Contact Resistance: | 200 milliohms max |
| Contact Rating: | 0.5 amp 200 VDC (10VA) 1.2 amps max. Continuous carry current |

TIMING

| | |
|---------------|--------------------------------|
| Operate time: | 1 mS or less @ nominal voltage |
| Release time: | 1 mS or less @ nominal voltage |

DIELECTRIC STRENGTH

| | |
|------------------------|--------------------------------|
| Across Open Contacts: | 150 V rms |
| Between Mutually | |
| Insulation Points: | 500 V rms |
| Insulation Resistance: | 1000 megohms min. @ 500 VDC |
| Capacitance: | 1.0 pf typical coil to contact |

TEMPERATURE

| | |
|------------|----------------------------------|
| Operating: | -40°C to +85°C @ rated operation |
| Storage: | -40°C to +105°C |

SHOCK RESISTANCE

| | |
|------------|--------|
| Operating: | 50 g's |
|------------|--------|

VIBRATION RESISTANCE

| | |
|------------|-------------------------|
| Operating: | 20 g's, 40 Hz to 200 Hz |
|------------|-------------------------|

LIFE EXPECTANCY

| | |
|-------------|---|
| Electrical: | 50,000,000 operations @ 5-10 V @ 10 mA |
| Mechanical: | 100,000,000 operations @ no load |

MISCELLANEOUS

| | |
|---------------------|----------------|
| Operating Position: | Any |
| Enclosure: | Epoxy molded |
| Weight: | 1 gram approx. |

WHEN SPACING SIP RELAYS, THE RELAYS REQUIRE 1/2 INCH SPACING FROM THE SIDE OF THE ADJACENT RELAYS.

OUTLINE DIMENSIONS
DIMENSIONS SHOWN IN INCHES & (MILLIMETERS).

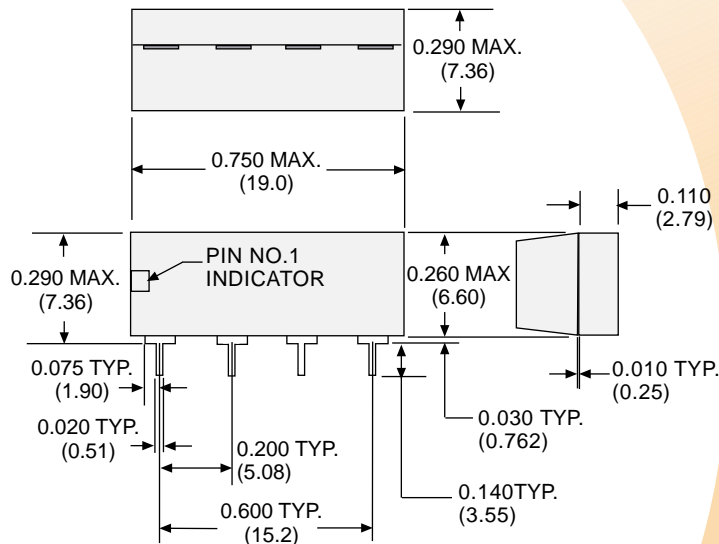

| WIRING DIAGRAMS (TOP VIEWED) | STANDARD PART NUMBERS | COIL MEASURED @ 25°C | | |
|---|-----------------------|-----------------------|---------------------------|--------------------|
| | | NOMINAL INPUT VOLTAGE | NOMINAL RESISTANCE (OHMS) | NOMINAL POWER (mW) |
| SPST - N. O. | | | | |
| | W117SIP-1 | 5 | 500 Ω | 50 |
| | W117SIP-3 | 12 | 1000 Ω | 144 |
| | W117SIP-5 | 24 | 2000 Ω | 288 |
| SPST - N. C. | | | | |
| | W117SIP-22 | 5 | 500 Ω | 50 |
| | W117SIP-23 | 12 | 1200 Ω | 120 |
| | W117SIP-24 | 24 | 2200 Ω | 270 |
| SPST - N. O. WITH CLAMPING DIODE | | | | |
| | W117SIP-6 | 5 | 500 Ω | 50 |
| | W117SIP-8 | 12 | 1000 Ω | 144 |
| | W117SIP-10 | 24 | 2000 Ω | 288 |
| SPST - N. C. WITH CLAMPING DIODE | | | | |
| | W117SIP-18 | 5 | 500 Ω | 50 |
| | W117SIP-25 | 12 | 1200 Ω | 120 |
| | W117SIP-26 | 24 | 2200 Ω | 220 |

GENERAL SPECIFICATIONS

COIL

| | |
|-------------------|--------------------------------|
| Pull-in Voltage: | 85% of nominal voltage or less |
| Drop Out Voltage: | 10% of nominal voltage or more |
| Max. Voltage: | 110% of nominal voltage |
| Resistance: | ±10% measured @ 25°C |
| Coil Power: | See chart |
| Duty: | Continuous |

CONTACTS

| | |
|---------------------|---|
| Contact Material: | Rhodium |
| Contact Resistance: | 200 milliohms max. |
| Contact Rating: | 0.5 amp 100 VDC (10VA) 1.5 amps max. Continuous carry current. |

TIMING

| | |
|---------------|---------------------------------|
| Operate time: | 1 mS or less @ nominal voltage. |
| Reset time: | 1 mS or less @ nominal voltage. |

DIELECTRIC STRENGTH

| | |
|-------------------------------------|--|
| Across Open Contacts: | 200 V rms |
| Between Mutually Insulation Points: | 1000 V rms |
| Insulation Resistance: | 1000 megohms min. @ 500 VDC |
| Capacitance: | 2.0 pf typical contact to open contact |

TEMPERATURE

| | |
|------------|----------------------------------|
| Operating: | -40°C to +85°C @ rated operation |
| Storage: | -40°C to +105°C |

SHOCK RESISTANCE

| | |
|------------|--------|
| Operating: | 50 g's |
|------------|--------|

VIBRATION RESISTANCE

| | |
|-----------|-------------------------|
| Operating | 20 g's, 40 Hz to 200 Hz |
|-----------|-------------------------|

LIFE EXPECTANCY

| | |
|-------------|--|
| Electrical: | 50,000,000 operations @ 5-10 V @ 10 mA |
| Mechanical: | 100,000,000 operations @ no load |

MISCELLANEOUS

| | |
|---------------------|----------------|
| Operating Position: | Any |
| Enclosure: | Epoxy molded |
| Weight: | 1 gram approx. |

WHEN SPACING DIP RELAYS, THE RELAYS REQUIRE 1/2 INCH SPACING FROM THE SIDE OF THE ADJACENT RELAYS.

OUTLINE DIMENSIONS
DIMENSIONS SHOWN IN INCHES & (MILLIMETERS).

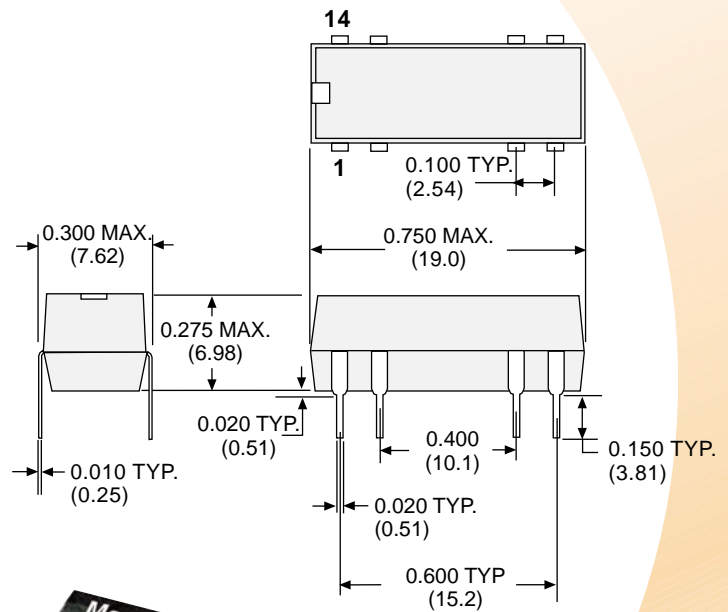

WIRING DIAGRAMS (TOP VIEWED)

SPST - N. O.

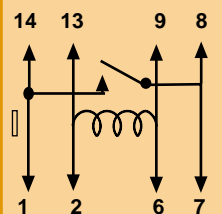

| STANDARD PART NUMBERS | COIL MEASURED @ 25°C | | |
|---|-----------------------|---------------------------|--------------------|
| | NOMINAL INPUT VOLTAGE | NOMINAL RESISTANCE (OHMS) | NOMINAL POWER (mW) |
| W107DIP-1 | 5 | 500 Ω | 50 |
| W107DIP-3 | 12 | 1000 Ω | 144 |
| W107DIP-4 | 24 | 2000 Ω | 288 |
| SPST - N. O. WITH CLAMPING DIODE | | | |
| W107DIP-5 | 5 | 500 Ω | 50 |
| W107DIP-7 | 12 | 1000 Ω | 144 |
| W107DIP-8 | 24 | 2000 Ω | 288 |

SPST - N. O. WITH CLAMPING DIODE

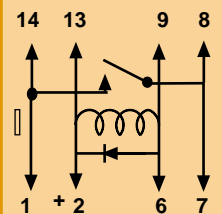

SEE END OF SECTION 6 FOR CROSS REFERENCE

**SPST-N.O. OR N.C., DPST-N.O.
0.5 AMP**

GENERAL SPECIFICATIONS

COIL

| | |
|-------------------|--------------------------------|
| Pull-in Voltage: | 85% of nominal voltage or less |
| Drop Out Voltage: | 10% of nominal voltage or more |
| Max. Voltage: | 110% of nominal voltage |
| Resistance: | ±10% measured @ 25°C |
| Coil Power: | See chart |
| Duty: | Continuous |

CONTACTS

| | |
|---------------------|---|
| Contact Material: | Rhodium |
| Contact Resistance: | 200 milliohms max. |
| Contact Rating: | 0.5 amp 100 VDC (10VA) 1.5 amps max continuous carry current |

TIMING

| | |
|---------------|--------------------------------|
| Operate time: | 1 mS or less @ nominal voltage |
| Release time: | 1 mS or less @ nominal Voltage |

DIELECTRIC STRENGTH

| | |
|--|-----------------------------------|
| Across Open Contacts: | 150 V rms |
| Between Mutually Insulation Points: | 500 V rms |
| Insulation Resistance: | 1000 megohms min. @ 100 VDC |
| Capacitance: | 1.0 pf typical contact to contact |

TEMPERATURE

| | |
|------------|----------------------------------|
| Operating: | -40°C to +85°C @ rated operation |
| Storage: | -40°C to +105°C |

SHOCK RESISTANCE

| | |
|------------|--------|
| Operating: | 50 g's |
|------------|--------|

VIBRATION RESISTANCE

| | |
|------------|-------------------------|
| Operating: | 20 g's, 40 Hz to 200 Hz |
|------------|-------------------------|

LIFE EXPECTANCY

| | |
|-------------|------------------------------------|
| Electrical: | 50,000,000 operations @ rated load |
| Mechanical: | 100,000,000 operations low level |

MISCELLANEOUS

| | |
|---------------------|----------------|
| Operating Position: | Any |
| Enclosure: | Epoxy molded |
| Weight: | 1 gram approx. |

OUTLINE DIMENSIONS
DIMENSIONS SHOWN IN INCHES & (MILLIMETERS).

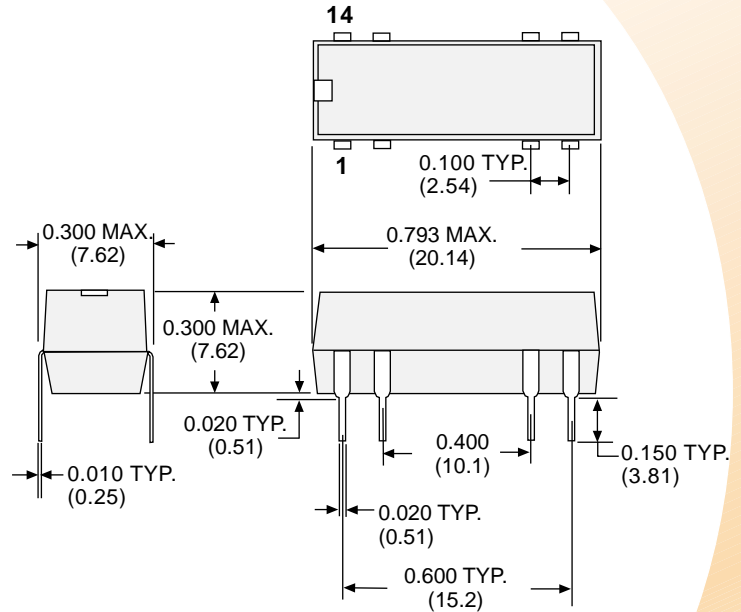

WHEN SPACING DIP RELAYS, THE RELAYS REQUIRE 1/2 INCH SPACING FROM THE SIDE OF THE ADJACENT RELAYS.

**SPST-N.O. OR N.C., DPST-N.O.
0.5 AMP**

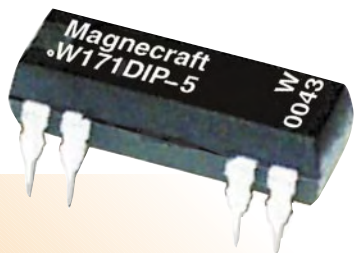

| WIRING DIAGRAMS (TOP VIEWED) | STANDARD PART NUMBERS | COIL MEASURED @ 25°C | | |
|---|-----------------------|-----------------------|---------------------------|--------------------|
| | | NOMINAL INPUT VOLTAGE | NOMINAL RESISTANCE (OHMS) | NOMINAL POWER (mW) |
| SPST - N. O. | | | | |
| | W171DIP-2 | 5 | 500 Ω | 50 |
| | W171DIP-4 | 12 | 1200 Ω | 120 |
| | W171DIP-5 | 24 | 2200 Ω | 270 |
| SPST - N. O. WITH CLAMPING DIODE | | | | |
| | W171DIP-7 | 5 | 500 Ω | 50 |
| | W171DIP-9 | 12 | 1000 Ω | 144 |
| | W171DIP-10 | 24 | 2200 Ω | 270 |
| SPST - N. C. | | | | |
| | W171DIP-12 | 5 | 200 Ω | 50 |
| | W171DIP-14 | 12 | 1200 Ω | 120 |
| | W171DIP-15 | 24 | 2200 Ω | 270 |
| SPST - N. C. WITH CLAMPING DIODE | | | | |
| | W171DIP-17 | 5 | 500 Ω | 50 |
| | W171DIP-19 | 12 | 1200 Ω | 120 |
| | W171DIP-20 | 24 | 2200 Ω | 270 |
| DPST - N. O. | | | | |
| | W171DIP-21 | 5 | 500 Ω | 50 |
| | W171DIP-23 | 12 | 1000 Ω | 144 |
| | W171DIP-24 | 24 | 2200 Ω | 270 |
| DPST - N. O. WITH CLAMPING DIODE | | | | |
| | W171DIP-25 | 5 | 500 Ω | 50 |
| | W171DIP-27 | 12 | 1000 Ω | 144 |
| | W171DIP-28 | 24 | 2200 Ω | 270 |

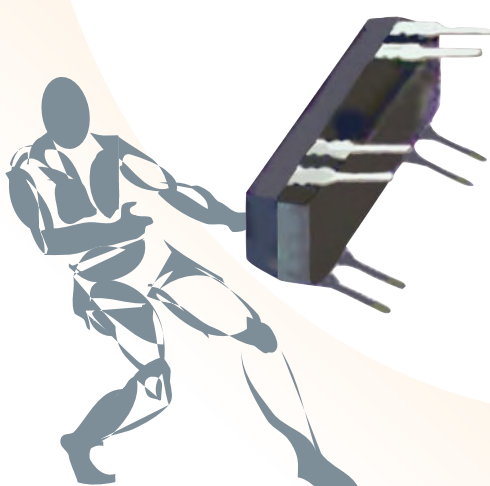

SEE END OF SECTION 6 FOR CROSS REFERENCE

SPST - N.O., 0.5 AMP

GENERAL SPECIFICATIONS

COIL

| | |
|-------------------|--------------------------------|
| Pull-in Voltage: | 85% of nominal voltage or less |
| Drop Out Voltage: | 10% of nominal voltage or more |
| Max. Voltage: | 110% of nominal voltage |
| Resistance: | ±10% measured @ 25°C |
| Coil Power: | See chart |
| Duty: | Continuous |

CONTACTS

| | |
|---------------------|---|
| Contact Material: | Rhodium |
| Contact Resistance: | 200 milliohms max |
| Contact Rating: | 0.5 amp 100 VDC (10VA) 1.5 amps max continuous carry current |

TIMING

| | |
|---------------|--------------------------------|
| Operate time: | 1 mS or less @ nominal voltage |
| Release time: | 1 mS or less @ nominal Voltage |

DIELECTRIC STRENGTH

| | |
|--|-----------------------------------|
| Across Open Contacts: | 150 V rms |
| Between Mutually Insulation Points: | 500 V rms |
| Insulation Resistance: | 1000 megohms min. @ 100 VDC |
| Capacitance: | 1.0 pf typical contact to contact |

TEMPERATURE

| | |
|------------|----------------------------------|
| Operating: | -40°C to +85°C @ rated operation |
| Storage: | -40°C to +105°C |

SHOCK RESISTANCE

| | |
|------------|--------|
| Operating: | 50 g's |
|------------|--------|

VIBRATION RESISTANCE

| | |
|------------|-------------------------|
| Operating: | 20 g's, 40 Hz to 200 Hz |
|------------|-------------------------|

LIFE EXPECTANCY

| | |
|-------------|---------------------------------------|
| Electrical: | 50,000,000 operations @ rated load |
| Mechanical: | 100,000,000 operations low level |

MISCELLANEOUS

| | |
|---------------------|----------------|
| Operating Position: | Any |
| Enclosure: | Epoxy molded |
| Weight: | 1 gram approx. |

OUTLINE DIMENSIONS
DIMENSIONS SHOWN IN INCHES & (MILLIMETERS).

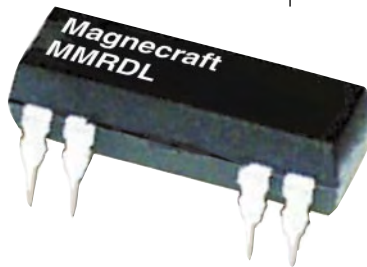
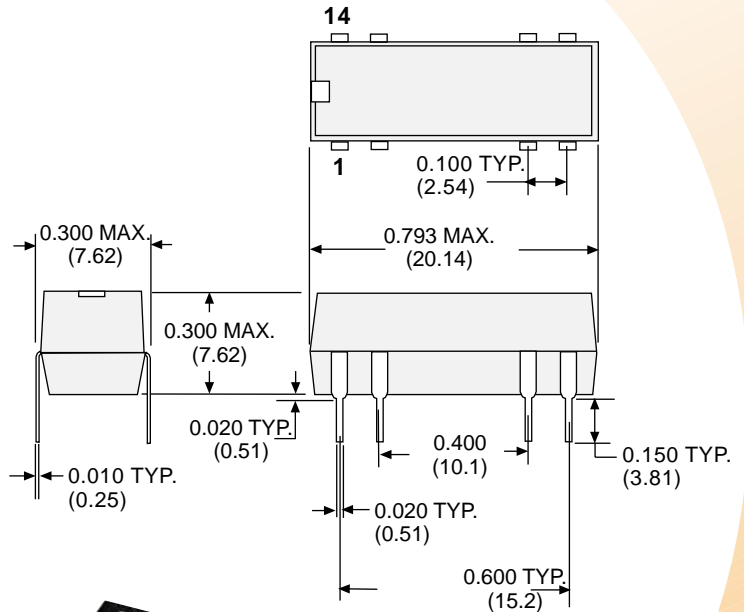

WHEN SPACING LATCHING DIP RELAYS, THE RELAYS REQUIRE 1 INCH SPACING BETWEEN ADJACENT RELAYS FROM END TO END.

WIRING DIAGRAMS (TOP VIEWED)

SPST - N. O.

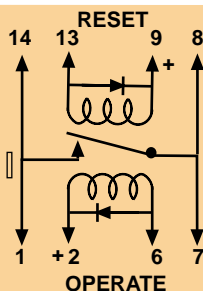

STANDARD PART NUMBERS

- MRRDL1AS8-5D
- MRRDL1AS8-12D
- MRRDL1AS8-24D

COIL MEASURED @ 25°C

| NOMINAL INPUT VOLTAGE | NOMINAL RESISTANCE (OHMS) | NOMINAL POWER (mW) |
|-----------------------|---------------------------|--------------------|
| 5 | 750 / 750 Ω | 35 |
| 12 | 1000 / 1000 Ω | 145 |
| 24 | 4600 / 4600 Ω | 125 |

GENERAL SPECIFICATIONS

COIL

| | |
|-------------------|--------------------------------|
| Pull-in Voltage: | 85% of nominal voltage or less |
| Drop Out Voltage: | 10% of nominal voltage or more |
| Max. Voltage: | 110% of nominal voltage |
| Resistance: | ±10% measured @ 25°C |
| Coil Power: | See chart |
| Duty: | Continuous |

CONTACTS

| | |
|---------------------|--|
| Contact Material: | Rhodium |
| Contact Resistance: | 200 milliohms max |
| Contact Rating: | 0.25 amp 100 VDC (4 VA) 0.5 amps max continuous carry current |

TIMING

| | |
|---------------|--------------------------------|
| Operate time: | 1 mS or less @ nominal voltage |
| Release time: | 1 mS or less @ nominal Voltage |

DIELECTRIC STRENGTH

| | |
|--|--------------------------------|
| Across Open Contacts: | 1000 V rms |
| Between Mutually Insulation Points: | 500 V rms |
| Insulation Resistance: | 1000 megohms min. @ 100 VDC |
| Capacitance: | 1.0 pf typical coil to contact |

TEMPERATURE

| | |
|------------|----------------------------------|
| Operating: | -40°C to +85°C @ rated operation |
| Storage: | -40°C to +105°C |

SHOCK RESISTANCE

| | |
|------------|--------|
| Operating: | 50 g's |
|------------|--------|

VIBRATION RESISTANCE

| | |
|------------|-------------------------|
| Operating: | 20 g's, 40 Hz to 200 Hz |
|------------|-------------------------|

LIFE EXPECTANCY

| | |
|-------------|--|
| Electrical: | 50,000,000 operations @ 50V/50mA |
| Mechanical: | 80,000,000 operations low level 10V/10mA |

MISCELLANEOUS

| | |
|---------------------|----------------|
| Operating Position: | Any |
| Enclosure: | Epoxy molded |
| Weight: | 1 gram approx. |

OUTLINE DIMENSIONS
DIMENSIONS SHOWN IN INCHES & (MILLIMETERS).

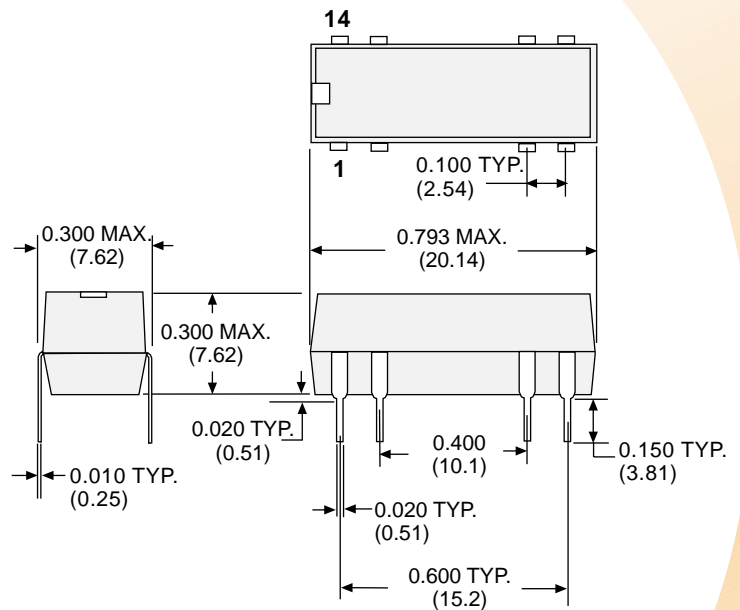

WHEN SPACING DIP RELAYS, THE RELAYS REQUIRE 1/2 INCH SPACING FROM THE SIDE OF THE ADJACENT RELAYS.



| WIRING DIAGRAMS (TOP VIEWED) | STANDARD PART NUMBERS | COIL MEASURED @ 25°C | | |
|-------------------------------------|-----------------------|-----------------------|---------------------------|--------------------|
| | | NOMINAL INPUT VOLTAGE | NOMINAL RESISTANCE (OHMS) | NOMINAL POWER (mW) |
| SPDT | W172DIP-1 | 5 | 200 Ω | 125 |
| | W172DIP-3 | 12 | 500 Ω | 300 |
| | W172DIP-4 | 24 | 2200 Ω | 270 |
| SPDT WITH CLAMPING DIODE | W172DIP-5 | 5 | 200 Ω | 125 |
| | W172DIP-7 | 12 | 500 Ω | 300 |
| | W172DIP-8 | 24 | 2200 Ω | 270 |
| SPDT | W172DIP-31 | 5 | 200 Ω | 125 |
| | W172DIP-33 | 12 | 500 Ω | 290 |
| | W172DIP-34 | 24 | 2200 Ω | 270 |
| SPDT WITH CLAMPING DIODE | W172DIP-35 | 5 | 200 Ω | 125 |
| | W172DIP-37 | 12 | 500 Ω | 290 |
| | W172DIP-38 | 24 | 2200 Ω | 270 |
| SPDT | W172DIP-141 | 5 | 200 Ω | 125 |
| | W172DIP-145 | 12 | 1000 Ω | 144 |
| | W172DIP-146 | 24 | 3200 Ω | 180 |
| SPDT WITH CLAMPING DIODE | W172DIP-147 | 5 | 200 Ω | 125 |
| | W172DIP-149 | 12 | 1000 Ω | 144 |
| | W172DIP-150 | 24 | 3200 Ω | 180 |

SEE END OF SECTION 6 FOR CROSS REFERENCE



DPDT, 1.0 AMP

GENERAL SPECIFICATIONS

COIL

| | |
|-------------------|--------------------------------|
| Pull-in Voltage: | 85% of nominal voltage or less |
| Drop Out Voltage: | 10% of nominal voltage or more |
| Max. Voltage: | 110% of nominal voltage |
| Resistance: | ±10 % measured @ 25°C |
| Coil Power: | See chart |
| Duty: | Continuous |

CONTACTS

| | |
|---------------------|---|
| Contact Material: | Rhodium |
| Contact Resistance: | 200 milliohms max. |
| Contact Rating: | 0.25 amp 100 VDC (4 VA) 0.5 amps max continuous carry current. |

TIMING

| | |
|---------------|---------------------------------|
| Operate time: | 1 mS or less @ nominal voltage. |
| Release time: | 1 mS or less @ nominal Voltage. |

DIELECTRIC STRENGTH

| | |
|-------------------------------------|--------------------------------|
| Across Open Contacts: | 1000 V rms |
| Between Mutually Insulation Points: | 500 V rms |
| Insulation Resistance: | 1000 megohms min. @ 100 VDC |
| Capacitance: | 1.0 pf typical coil to contact |

TEMPERATURE

| | |
|------------|----------------------------------|
| Operating: | -40°C to +85°C @ rated operation |
| Storage: | -40°C to +105°C |

SHOCK RESISTANCE

| | |
|------------|--------|
| Operating: | 50 g's |
|------------|--------|

VIBRATION RESISTANCE

| | |
|------------|-------------------------|
| Operating: | 20 g's, 40 Hz to 200 Hz |
|------------|-------------------------|

LIFE EXPECTANCY

| | |
|-------------|------------------------------------|
| Electrical: | 50,000,000 operations @ rated load |
| Mechanical: | 100,000,000 operations low level |

MISCELLANEOUS

| | |
|---------------------|----------------|
| Operating Position: | Any |
| Enclosure: | Epoxy molded |
| Weight: | 1 gram approx. |

WHEN SPACING DUAL IN - LINE REED RELAYS, THE RELAYS REQUIRE 1/2 INCH SPACING FROM THE SIDE OF THE ADJACENT RELAYS.

OUTLINE DIMENSIONS

DIMENSIONS SHOWN IN INCHES & (MILLIMETERS).

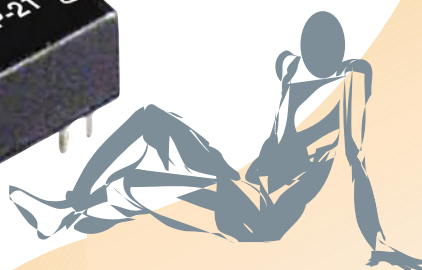
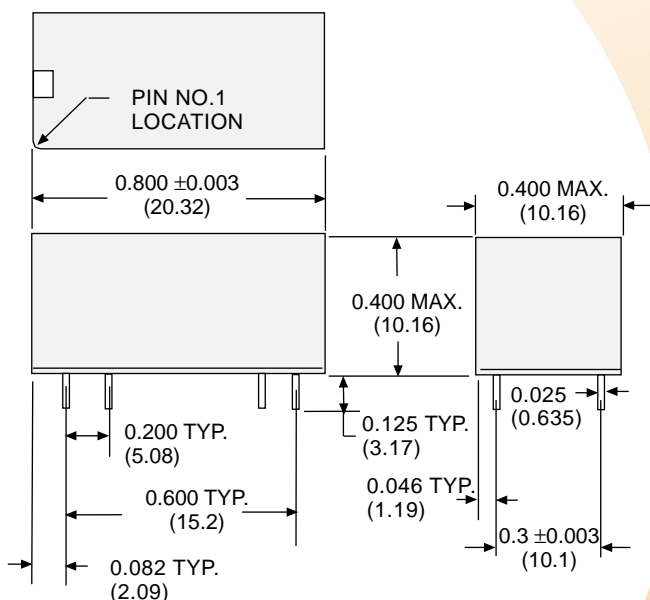

WIRING DIAGRAMS (TOP VIEWED)

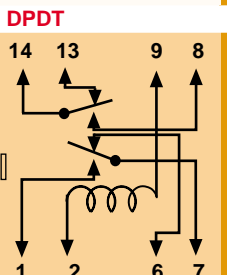

DPDT WITH CLAMPING DIODE

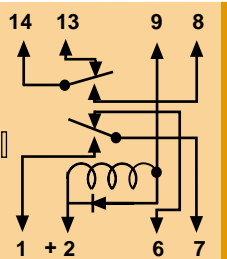

STANDARD PART NUMBERS

COIL MEASURED @ 25°C

| NOMINAL INPUT VOLTAGE | NOMINAL RESISTANCE (OHMS) | NOMINAL POWER (mW) |
|-----------------------|---------------------------|--------------------|
|-----------------------|---------------------------|--------------------|

W172DIP-17

5

46 Ω

540

W172DIP-19

12

266 Ω

540

W172DIP-20

24

1066 Ω

540

W172DIP-21

5

46 Ω

540

W172DIP-23

12

266 Ω

540

W172DIP-24

24

1066 Ω

540

SPDT - NO, SPDT, DPST-NO, DPDT, 0.5 AMP

PIN SPACING OF 0.100" IS STANDARD. PIN SPACING OF 0.150 IS AVAILABLE ON SPECIAL ORDER. ALSO AVAILABLE ARE MODELS WITH ELECTROSTATIC SHIELDS. CONSULT FACTORY FOR PART NUMBERS. NONSTANDARD SCHEMATICS AND PIN-OUTS CAN ALSO BE PRODUCED FOR SPECIFIC CUSTOMER REQUIREMENTS.

GENERAL SPECIFICATIONS

COIL

| | |
|-------------------|--------------------------------|
| Pull-in Voltage: | 85% of nominal voltage or less |
| Drop Out Voltage: | 10% of nominal voltage or more |
| Max. Voltage: | 110% of nominal voltage |
| Resistance: | ±10 % measured @ 25°C |
| Coil Power: | See chart |
| Duty: | Continuous |

CONTACTS

| | |
|---------------------|---|
| Contact Material: | Rhodium |
| Contact Resistance: | 200 milliohms max. |
| Contact Rating: | 10 VA -SPST - NO. & SPDT 4 VA -DPST - NO. & DPDT 0.5 amps max continuous carry current. |

TIMING

| | |
|---------------|---------------------------------|
| Operate time: | 1 mS or less @ nominal voltage. |
| Release time: | 1 mS or less @ nominal Voltage. |

DIELECTRIC STRENGTH

| | |
|-------------------------------------|------------------------------|
| Across Open Contacts: | 1000 VDC |
| Between Mutually Insulation Points: | 1000 VDC |
| Insulation Resistance: | 1000 megohms min. @ 100 VDC |
| Capacitance: | 3 pf typical coil to contact |

TEMPERATURE

| | |
|------------|----------------------------------|
| Operating: | -40°C to +85°C @ rated operation |
| Storage: | -40°C to +105°C |

SHOCK RESISTANCE

| | |
|------------|--------|
| Operating: | 50 g's |
|------------|--------|

VIBRATION RESISTANCE

| | |
|------------|-------------------------|
| Operating: | 20 g's, 40 Hz to 200 Hz |
|------------|-------------------------|

LIFE EXPECTANCY

| | |
|-------------|------------------------------------|
| Electrical: | 10,000,000 operations @ rated load |
| Mechanical: | 100,000,000 operations @ no load |

MISCELLANEOUS

| | |
|---------------------|--------------------|
| Operating Position: | Any |
| Enclosure: | Epoxy encapsulated |
| Weight: | 1 gram approx. |

SIZE I



SIZE II

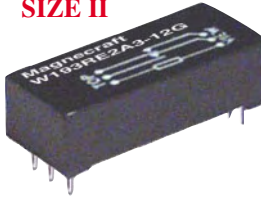

OUTLINE DIMENSIONS
DIMENSIONS SHOWN IN INCHES & (MILLIMETERS).

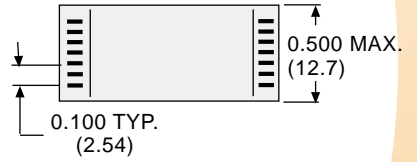
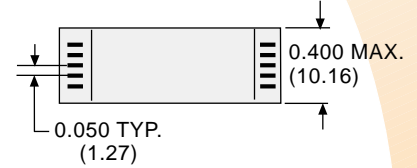
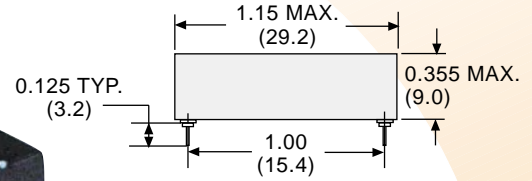

Spacing between filled in circles in schematics are on 0.100 grid patterns. Pin omitted on unfilled circles.

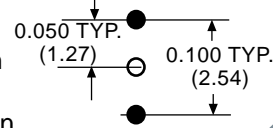

| CASE SIZE | WIRING DIAGRAMS (TOP VIEWED) | STANDARD PART NUMBERS | COIL MEASURED @ 25°C | | |
|---------------------|------------------------------|-----------------------|-----------------------|---------------------------|--------------------|
| | | | NOMINAL INPUT VOLTAGE | NOMINAL RESISTANCE (OHMS) | NOMINAL POWER (mW) |
| SPST - N. O. | | | | | |
| I | | W193RE1A3-12G | 12 | 420 Ω | 350 |
| | | W193RE1A3-24G | 24 | 2300 Ω | 250 |
| SPDT | | | | | |
| I | | W193RE1C3-12G | 12 | 420 Ω | 350 |
| | | W193RE1C3-24G | 24 | 2300 Ω | 250 |
| DPST - N. O. | | | | | |
| II | | W193RE2A3-12G | 12 | 280 Ω | 500 |
| | | W193RE2A3-24G | 24 | 1500 Ω | 390 |
| DPDT | | | | | |
| II | | W193RE2C3-12G | 12 | 280 Ω | 500 |
| | | W193RE2C3-24G | 24 | 1500 Ω | 390 |

3PST-N.O. 4PST-N.O.,
3PDT & 4PDT., 0.5 AMP

SIZE III

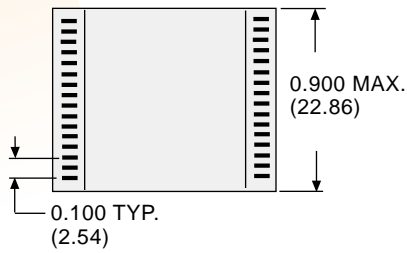
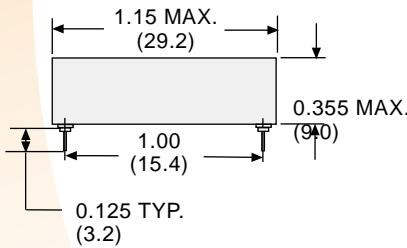
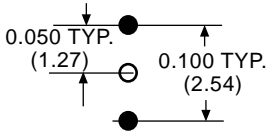
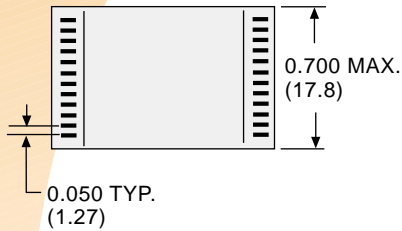

SIZE IV

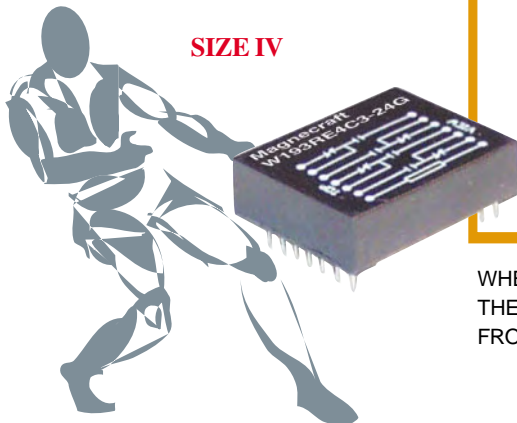

| CASE SIZE | WIRING DIAGRAMS (TOP VIEWED) | STANDARD PART NUMBERS | COIL MEASURED @ 25°C | | | |
|-----------|------------------------------|--------------------------------|-----------------------|---------------------------|--------------------|--|
| | | | NOMINAL INPUT VOLTAGE | NOMINAL RESISTANCE (OHMS) | NOMINAL POWER (mW) | |
| III | 3PST - N. O. | | | | | |
| | | W193RE3A3-12G W193RE3A3-24G | 12 24 | 210 Ω 1150 Ω | 690 500 | |
| III | 3PDT | | | | | |
| | | W193RE3C3-12G W193RE3C3-24G | 12 24 | 210 Ω 1150 Ω | 690 500 | |
| III | 4PST - N. O. | | | | | |
| | | W193RE4A3-12G W193RE4A3-24G | 12 24 | 210 Ω 1150 Ω | 690 500 | |
| IV | 4PDT | | | | | |
| | | W193RE4C3-12G W193RE4C3-24G | 12 24 | 140 Ω 770 Ω | 1030 750 | |

WHEN SPACING MINIATURE REED RELAYS, THE RELAYS REQUIRE 1/2 INCH SPACING FROM THE SIDE OF THE ADJACENT RELAYS.

SPDT & DPDT, 2 AMP

PIN SPACING OF 0.100" IS STANDARD. PIN SPACING OF 0.150 IS AVAILABLE ON SPECIAL ORDER. ALSO AVAILABLE ARE MODELS WITH ELECTROSTATIC SHIELDS. CONSULT FACTORY FOR PART NUMBERS. NONSTANDARD SCHEMATICS AND PIN-OUTS CAN ALSO BE PRODUCED FOR SPECIFIC CUSTOMER REQUIREMENTS.

GENERAL SPECIFICATIONS

| COIL | |
|-------------------|--------------------------------|
| Pull-in Voltage: | 85% of nominal voltage or less |
| Drop Out Voltage: | 10% of nominal voltage or more |
| Max. Voltage: | 110% of nominal voltage |
| Resistance: | ±10 % measured @ 25°C |
| Coil Power: | See chart |
| Duty: | Continuous |

| CONTACTS | |
|---------------------|--|
| Contact Material: | Rhodium/Mercury |
| Contact Resistance: | 100 milliohms max. |
| Contact Rating: | 2 amp 500 VDC (50VA) 3 amps max continuous carry current. |

| TIMING | |
|---------------|-----------------------------------|
| Operate time: | 2.0 mS or less @ nominal voltage. |
| Reset time: | 2.5 mS or less @ nominal Voltage. |

| DIELECTRIC STRENGTH | |
|------------------------|--------------------------------|
| Across Open Contacts: | 1000 VDC |
| Between Mutually | |
| Insulation Points: | 1000 VDC |
| Insulation Resistance: | 1000 megohms min. @ 100 VDC |
| Capacitance: | 2.0 pf typical coil to contact |

| TEMPERATURE | |
|-------------|----------------------------------|
| Operating: | -37°C to +85°C @ rated operation |
| Storage: | -40°C to +105°C |

| SHOCK RESISTANCE | |
|------------------|--------|
| Operating: | 50 g's |

| VIBRATION RESISTANCE | |
|----------------------|-------------------------|
| Operating: | 20 g's, 40 Hz to 200 Hz |

| LIFE EXPECTANCY | |
|-----------------|------------------------------------|
| Electrical: | 50,000,000 operations @ rated load |
| Mechanical: | 10,000,000 operations @ no load |

| MISCELLANEOUS | |
|---------------------|--------------------|
| Operating Position: | Vertical ±15% |
| Enclosure: | Epoxy encapsulated |
| Weight: | 1 gram approx. |

WHEN SPACING MINIATURE REED RELAYS, THE RELAYS REQUIRE 1/2 INCH SPACING FROM THE SIDE OF THE ADJACENT RELAYS.

OUTLINE DIMENSIONS

DIMENSIONS SHOWN IN INCHES & (MILLIMETERS).

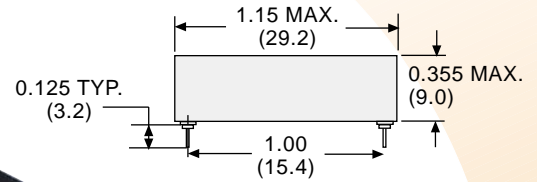

SIZE I

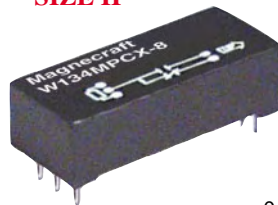
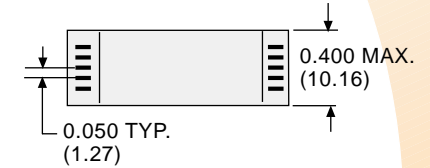

SIZE II

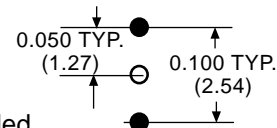
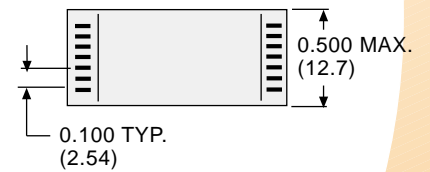

Spacing between filled in circles in schematics are on 0.100 grid patterns. Pin omitted on unfilled circles.

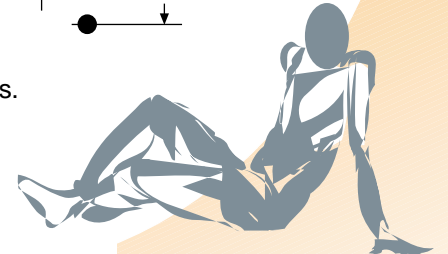

| CASE SIZE | WIRING DIAGRAMS (TOP VIEWED) | STANDARD PART NUMBERS | COIL MEASURED @ 25°C | | |
|-----------|------------------------------|-----------------------|-----------------------|---------------------------|--------------------|
| | | | NOMINAL INPUT VOLTAGE | NOMINAL RESISTANCE (OHMS) | NOMINAL POWER (mW) |
| I | | W134MPCX-2 | 12 | 330 Ω | 435 |
| | | W134MPCX-3 | 24 | 1400 Ω | 410 |
| II | | W134MPCX-8 | 12 | 230 Ω | 620 |
| | | W134MPCX-11 | 12 | 230 Ω | 620 |

**SPST - N.O.,
5 TO 10 MILLIAMPS**

**EPOXY ENCAPSULATED HIGH VOLTAGE REED.
SPST-NO TUNGSTEN CONTACTS
SWITCHES LOADS UP TO 10 MA @ 5000 VOLTS DC
CLASS 102HV SAME AS ABOVE EXCEPT:
SWITCHES 10,000 VOLTS WITH LOADS UP TO 5 mA DC**

GENERAL SPECIFICATIONS

COIL

| | |
|-------------------|--------------------------------|
| Pull-in Voltage: | 75% of nominal voltage or less |
| Drop Out Voltage: | 10% of nominal voltage or more |
| Max. Voltage: | 110% of nominal voltage |
| Resistance: | ±10 % measured @ 25°C |
| Coil Power: | See chart |
| Duty: | Continuous |

CONTACTS

| | |
|---------------------|-------------------------------------|
| Contact Material: | Tungsten |
| Contact Resistance: | 200 milliohms max |
| Contact Rating: | 10 ma 5000 VDC 5 ma @ 10,000 VDC |

TIMING

| | |
|---------------|--------------------------------|
| Operate time: | 1 mS or less @ nominal voltage |
| Release time: | 1 mS or less @ nominal Voltage |

DIELECTRIC STRENGTH

| | |
|--|------------------------------|
| Across Open Contacts: | 12,000 VDC |
| Between Mutually Insulation Points: | 12,000 VDC |
| Insulation Resistance: | 1000 megohms min. @ 500 VDC |
| Capacitance: | 5 pf typical coil to contact |

TEMPERATURE

| | |
|------------|----------------------------------|
| Operating: | -40°C to +85°C @ rated operation |
| Storage: | -40°C to +105°C |

SHOCK RESISTANCE

| | |
|------------|------------------------------|
| Operating: | 30 g's, 11 mS, 1/2 sine wave |
|------------|------------------------------|

VIBRATION RESISTANCE

| | |
|------------|--------------------------|
| Operating: | 10 g's, 10 Hz to 1000 Hz |
|------------|--------------------------|

LIFE EXPECTANCY

| | |
|-------------|-----------------------------------|
| Electrical: | 1,000,000 operations @ rated load |
| Mechanical: | 10,000,000 operations @ no load |

MISCELLANEOUS

| | |
|---------------------|--------------------|
| Operating Position: | Any |
| Enclosure: | Epoxy encapsulated |
| Weight: | 49 grams approx. |

OUTLINE DIMENSIONS
DIMENSIONS SHOWN IN INCHES & (MILLIMETERS).



Do not use wire heavier than #22 AWG. Excess stress on terminals could cause damage to internal components

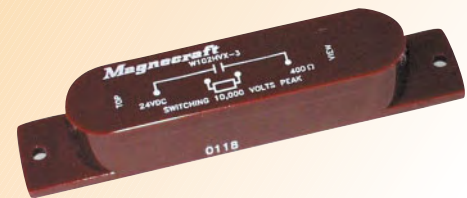

**WIRING
DIAGRAMS
(TOP VIEWED)**

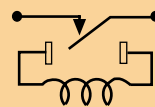

COIL MEASURED @ 25°C

| STANDARD PART NUMBERS | NOMINAL INPUT VOLTAGE | NOMINAL RESISTANCE (OHMS) | NOMINAL POWER (mW) |
|-----------------------------------|-----------------------|---------------------------|--------------------|
| 5,000 VOLTS NORMALLY OPEN | | | |
| W102VX-49 | 6 VDC | 70 Ω | 500 mW |
| W102VX-50 | 12 VDC | 250 Ω | 580 mW |
| W102VX-51 | 24 VDC | 1000 Ω | 580 mW |
| 10,000 VOLTS NORMALLY OPEN | | | |
| W102HVX-3 | 24 VDC | 400 Ω | 1.5 Watts |

SPDT, 150 WATTS

PANEL MOUNT WITH RG58C/U

CABLE (50 OHM)

SWITCHING 150 WATTS UP TO 470 MHZ

GENERAL SPECIFICATIONS

COIL

| | |
|-------------------|--------------------------------|
| Pull-in Voltage: | 75% of nominal voltage or less |
| Drop Out Voltage: | 10% of nominal voltage or more |
| Max. Voltage: | 110% of nominal voltage |
| Resistance: | ±10 % measured @ 25°C |
| Coil Power: | See chart |
| Duty: | Continuous |

CONTACTS

| | |
|---------------------|--------------------------------|
| Contact Material: | Silver alloy |
| Contact Resistance: | 50 milliohms max. & rated load |
| Contact Rating: | 150 watts 85 V rms |

TIMING

| | |
|---------------|----------------------------------|
| Operate time: | 15 mS or less @ nominal voltage. |
| Reset time: | 7 mS or less @ nominal voltage. |

DIELECTRIC STRENGTH

| | |
|------------------------|---------------------------------------|
| Across Open Contacts: | 500 V rms |
| Between Mutually | |
| Insulation Points: | 1000 V rms |
| Insulation Resistance: | 1000 megohms min. @ 500 VDC |
| Capacitance: | 30 pf maximum contact to open contact |

TEMPERATURE

| | |
|------------|----------------------------------|
| Operating: | -55°C to +65°C @ rated operation |
| Storage: | -55°C to +105°C |

LIFE EXPECTANCY

| | |
|-------------|-----------------------------------|
| Electrical: | 5,000,000 operations @ rated load |
| Mechanical: | 100,000 operations @ no load |

MISCELLANEOUS

| | |
|---------------------|------------------|
| Operating Position: | Any |
| Enclosure: | Metal |
| Weight: | 85 grams approx. |

OUTLINE DIMENSIONS
DIMENSIONS SHOWN IN INCHES & (MILLIMETERS).

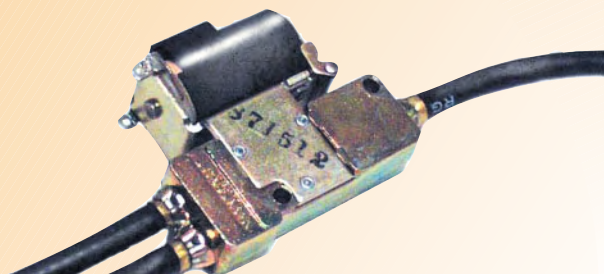

| WIRING DIAGRAMS (SIDE VIEW COIL DOWN) | STANDARD PART NUMBERS | COIL MEASURED @ 25°C | | |
|--|-----------------------|-----------------------|---------------------------|--------------------|
| | | NOMINAL INPUT VOLTAGE | NOMINAL RESISTANCE (OHMS) | NOMINAL POWER (mW) |
| <p>SPDT</p> | W120X-14 | 12 VDC | 500 Ω | 288 |



SECTION 6 CROSS REFERENCE GUIDE

| MAGNECRAFT & STRUTHERS-DUNN | POTTER & BRUMFIELD | CLARE | COTO | COTO SPARTIN | GORDOS | HAMLIN | MEDER |
|-----------------------------|--------------------|------------|----------|--------------|---------|-----------|----------------|
| W117SIP-1 | JWS-117-1 | DSS41A05 | 90010500 | | 741A-9 | 3621A0500 | SIL05-1A75-71L |
| W117SIP-3 | JWS-117-3 | DSS41A12 | 90011201 | | 741A-3 | 3621A1200 | SIL12-1A75-71L |
| W117SIP-5 | JWS-117-5 | DSS41A24 | | | 741A-7 | 3621A2400 | SIL24-1A75-71L |
| W117SIP-22 | JWS-117-12 | DSS41B05 | | | 741B-3 | | |
| W117SIP-23 | JWS-117-14 | DSS41B12 | | | 741B-5 | | |
| W117SIP-24 | JWS-117-15 | DSS41B24 | | | 741B-8 | | |
| W117SIP-6 | JWS-117-6 | DSS41A05B | | | 741B-10 | 3621A0510 | SIL05-1A75-71D |
| W117SIP-8 | JWS-117-8 | DSS41A12B | | | 741A-4 | 3621A1210 | SIL12-1A75-71D |
| W117SIP-10 | JWS-117-110 | DSS41A24B | | | 741A-8 | 3621A2410 | SIL24-1A75-71D |
| W117SIP-18 | JWS-117-17 | DSS41B05B | | | 741B-4 | | |
| W117SIP-25 | JWS-117-19 | DSS41B12B | | | 741B-6 | | |
| W117SIP-26 | JWS-117-30 | DSS41B24B | | | 741B-8 | | |
| MAGNECRAFT & STRUTHERS-DUNN | POTTER & BRUMFIELD | CLARE | COTO | COTO SPARTIN | GORDOS | HAMLIN | MEDER |
| W107DIP-1 | JWD-107-1 | PRMA10037 | | | 831A-3 | | DIP05-1A75-11L |
| W107DIP-3 | JWD-107-3 | PRMA10038 | | | 831A-5 | | DIP12-1A75-11L |
| W107DIP-4 | | PRMA10039 | | | 831A-7 | | DIP24-1A75-11L |
| W107DIP-5 | JWD-107-5 | PRMA10037B | | | 831A-4 | | DIP05-1A75-11D |
| W107DIP-7 | JWD-107-7 | PRMA10038B | | | 831A-6 | | DIP12-1A75-11D |
| W107DIP-8 | | PRMA10039B | | | 831A-8 | | DIP24-1A75-11D |
| MAGNECRAFT & STRUTHERS-DUNN | POTTER & BRUMFIELD | CLARE | COTO | COTO SPARTIN | GORDOS | HAMLIN | MEDER |
| W171DIP-2 | | PRMA1A05 | 80010500 | 8L01-05-001 | 831A-3 | 721A0500 | DIP05-1A75-11L |
| W171DIP-4 | | PRMA1A12 | 80011200 | 8L01-12-001 | 831A-5 | 721A1200 | DIP12-1A75-11L |
| W171DIP-5 | JWD-171-5 | PRMA1A24 | | 8L01-24-001 | 831A-7 | 721A2400 | DIP24-1A75-11L |
| W171DIP-7 | | PRMA1A05B | 80010510 | 8L01-05-011 | 831A-4 | 721A0510 | DIP05-1A75-11D |
| W171DIP-9 | | PRMA1A12B | 80011210 | 8L01-12-011 | 831A-6 | 721A1210 | DIP12-1A75-11D |
| W171DIP-10 | JWD-171-10 | PRMA1A24B | | 8L01-24-011 | 831A-8 | 721A2410 | DIP24-1A75-11D |
| W171DIP-12 | JWD-171-12 | PRMA1B05 | 80210500 | 8L21-05-001 | 831B-3 | 721B0500 | DIP05-1B75-11L |
| W171DIP-14 | JWD-171-14 | PRMA1B12 | 80211200 | 8L21-12-001 | 831B-5 | 721B1200 | DIP12-1B75-11L |
| W171DIP-15 | JWD-171-15 | PRMA1B24 | | 8L21-24-001 | 831B-7 | 721B2400 | DIP24-1B75-11L |
| W171DIP-17 | JWD-171-17 | PRMA1B05B | 80210510 | 8L21-05-011 | 831B-4 | 721B0510 | DIP05-1B75-11D |
| W171DIP-19 | JWD-171-19 | PRMA1B12B | 80211210 | 8L21-12-011 | 831B-6 | 721B1210 | DIP12-1B75-11D |
| W171DIP-20 | JWD-171-20 | PRMA1B24B | | 8L21-24-011 | 831B-8 | 721B2410 | DIP24-1B75-11D |
| W171DIP-21 | JWD-171-21 | PRMA2A05 | 80020500 | 8L02-05-001 | 832A-3 | 722A0500 | DIP05-2A75-21L |
| W171DIP-23 | JWD-171-23 | PRMA2A12 | 80021200 | 8L02-12-001 | 832B-5 | 722A1200 | DIP12-2A75-21L |
| W171DIP-24 | JWD-171-24 | PRMA2A24 | | 8L02-24-001 | 832B-7 | 722A2400 | DIP24-2A75-21L |
| W171DIP-25 | JWD-171-25 | PRMA2A05B | 80020510 | 8L02-05-011 | 832B-4 | 722A0510 | DIP05-2A75-21D |
| W171DIP-27 | JWD-171-27 | PRMA2A12B | 80021210 | 8L02-12-011 | 832B-6 | 722A1210 | DIP12-2A75-21D |
| W171DIP-28 | JWD-171-28 | PRMA2A24B | | 8L02-24-011 | 831B-8 | 722A2410 | DIP24-2A75-21D |
| MAGNECRAFT & STRUTHERS-DUNN | POTTER & BRUMFIELD | | | | GORDOS | | |
| W172DIP-1 | JWD-172-1 | | | | 836C-1 | 721R0500 | |
| W172DIP-3 | JWD-172-3 | | | | 836C-3 | 721R1200 | |
| W172DIP-4 | JWD-172-4 | | | | 836C-5 | 721R2400 | |
| W172DIP-5 | JWD-172-5 | | | | 836C-2 | 721R0510 | |
| W172DIP-7 | JWD-172-7 | | | | 836C-4 | 721R1210 | |
| W172DIP-8 | JWD-172-8 | | | | 836C-6 | 721R2410 | |

THE CROSS REFERENCE IS INTENDED TO MATCH FOOT PRINT, INTERNAL WIRING, AND CONTACT LOAD RATINGS. CONSTRUCTION FEATURES AND GENERAL SPECIFICATIONS SHOULD BE COMPARED IF EXACT REPLACEMENT IS REQUIRED.



SECTION 6 CROSS REFERENCE GUIDE

| MAGNECRAFT & STRUTHERS-DUNN | POTTER & BRUMFIELD | GORDOS | HAMLIN | MEDER | CLARE | COTO |
|-----------------------------|--------------------|--------|----------|----------------|-----------|----------|
| W172DIP-17 | | 835C-1 | | | | |
| W172DIP-19 | | 835C-3 | | | | |
| W172DIP-20 | | 835C-5 | | | | |
| W172DIP-21 | | 835C-2 | | | | |
| W172DIP-23 | | 835C-4 | | | | |
| W172DIP-24 | | 835C-6 | | | | |
| W172DIP-141 | JWD-172-155 | 831C-1 | 721C0500 | DIP05-1C75-51L | PRMA1C05 | 80410500 |
| W172DIP-145 | JWD-172-157 | 831C-3 | 721C1200 | DIP12-1C75-51L | PRMA1C12 | 80411200 |
| W172DIP-146 | JWD-172-158 | 831C-5 | 721C2400 | DIP24-1C75-51L | PRMA1C24 | |
| W172DIP-147 | JWD-172-159 | 831C-2 | 721C0510 | DIP05-1C75-51D | PRMA1C05B | 80410510 |
| W172DIP-149 | JWD-172-161 | 831C-4 | 721C1210 | DIP12-1C75-51D | PRMA1C12B | 80411210 |
| W172DIP-150 | JWD-172-162 | 831C-6 | 721C2410 | DIP24-1C75-51D | PRMA1C24B | |
| W172DIP-31 | | 831C-1 | 721E0500 | | | 80510500 |
| W172DIP-33 | | 831C-3 | 721E1200 | | | 80511200 |
| W172DIP-34 | | 831C-5 | 721E2400 | | | |
| W172DIP-35 | | | 721E0510 | | | 80510510 |
| W172DIP-37 | | | 721E1210 | | | 80511210 |
| W172DIP-38 | | | 721E2410 | | | |

THE CROSS REFERENCE IS INTENDED TO MATCH FOOT PRINT, INTERNAL WIRING, AND CONTACT LOAD RATINGS. CONSTRUCTION FEATURES AND GENERAL SPECIFICATIONS SHOULD BE COMPARED IF EXACT REPLACEMENT IS REQUIRED.

FOR REED RELAY APPLICATION ENGINEERING ASSISTANCE

Joseph Zintel, PRODUCT MANAGER

FAX: (843) 395-8530

EMAIL: jzintel@magnecraft.com

FAX ON DEMAND: 1-800-891-2957

DOCUMENT: 500

U. S. A.

TELEPHONE: (843) 393-5778

FAX: (843) 393-4123

WEBSITE: www.magnecraft.com

EMAIL: info@magnecraft.com

EUROPE

TELEPHONE: 4989 / 75080310

FAX: 4989 / 7559344

WEBSITE: www.magnecraft.com

EMAIL: renatesteinback@magnecraft.de



Компания «Океан Электроники» предлагает заключение долгосрочных отношений при поставках импортных электронных компонентов на взаимовыгодных условиях!

Наши преимущества:

- Поставка оригинальных импортных электронных компонентов напрямую с производств Америки, Европы и Азии, а так же с крупнейших складов мира;
- Широкая линейка поставок активных и пассивных импортных электронных компонентов (более 30 млн. наименований);
- Поставка сложных, дефицитных, либо снятых с производства позиций;
- Оперативные сроки поставки под заказ (от 5 рабочих дней);
- Экспресс доставка в любую точку России;
- Помощь Конструкторского Отдела и консультации квалифицированных инженеров;
- Техническая поддержка проекта, помощь в подборе аналогов, поставка прототипов;
- Поставка электронных компонентов под контролем ВП;
- Система менеджмента качества сертифицирована по Международному стандарту ISO 9001;
- При необходимости вся продукция военного и аэрокосмического назначения проходит испытания и сертификацию в лаборатории (по согласованию с заказчиком);
- Поставка специализированных компонентов военного и аэрокосмического уровня качества (Xilinx, Altera, Analog Devices, Intersil, Interpoint, Microsemi, Actel, Aeroflex, Peregrine, VPT, Syfer, Eurofarad, Texas Instruments, MS Kennedy, Miteq, Cobham, E2V, MA-COM, Hittite, Mini-Circuits, General Dynamics и др.);

Компания «Океан Электроники» является официальным дистрибьютором и эксклюзивным представителем в России одного из крупнейших производителей разъемов военного и аэрокосмического назначения «JONHON», а так же официальным дистрибьютором и эксклюзивным представителем в России производителя высокотехнологичных и надежных решений для передачи СВЧ сигналов «FORSTAR».



JONHON

«JONHON» (основан в 1970 г.)

Разъемы специального, военного и аэрокосмического назначения:

(Применяются в военной, авиационной, аэрокосмической, морской, железнодорожной, горно- и нефтедобывающей отраслях промышленности)

«FORSTAR» (основан в 1998 г.)

ВЧ соединители, коаксиальные кабели, кабельные сборки и микроволновые компоненты:

(Применяются в телекоммуникациях гражданского и специального назначения, в средствах связи, РЛС, а так же военной, авиационной и аэрокосмической отраслях промышленности).



Телефон: 8 (812) 309-75-97 (многоканальный)

Факс: 8 (812) 320-03-32

Электронная почта: ocean@oceanchips.ru

Web: <http://oceanchips.ru/>

Адрес: 198099, г. Санкт-Петербург, ул. Калинина, д. 2, корп. 4, лит. А