

# AVO50 Series DC/DC Converter

## Technical Reference Notes

Industry Standard Eighth Brick: 36~75V Input, 1.2V~12V Single Output



Industry standard eighth brick: 2.28" × 0.9" × 0.35"

### Options

- Choice of positive logic or negative logic for CNT function
- Choice of short pins or long pins

### Description

The AVO50 series DC/DC converter (for short, converter) is a new open frame DC/DC converter for optimum efficiency and power density. The converter provides up to 25A output current, which makes it an ideal choice for small space, high current and low voltage applications. The converter uses an industry standard eighth brick: 57.9mm × 22.9mm × 8.9mm (2.28" × 0.9" × 0.35") and standard pinout configuration, and provide CNT and trim functions. The converters can provide 1.2V to 12V single output. Outputs are isolated from inputs. The converter can achieve ultra high efficiency. For most applications, a heat sink is not required.

### Features

- Delivers up to 25A output current
- Industry standard eighth brick foot print 57.9mm × 22.9mm × 8.9mm (2.28" × 0.9" × 0.35")
- Basic isolation
- Ultra high efficiency: 91% at 5V full load (Vin = 48Vdc)
- Improved thermal performance: full load at 55°C at 1m/s (200LFM) for 5Vo
- High power density
- Low output noise
- 2:1 wide input voltage of 36V-75V
- CNT function
- Remote sense
- Trim function: +10%/-20%
- Input under-voltage lockout
- Output over-current protection
- Output over-voltage protection
- Over-temperature protection
- RoHS compliant

## Converter Numbering

**AVO 50 – 48 S 1V5 P - 4**

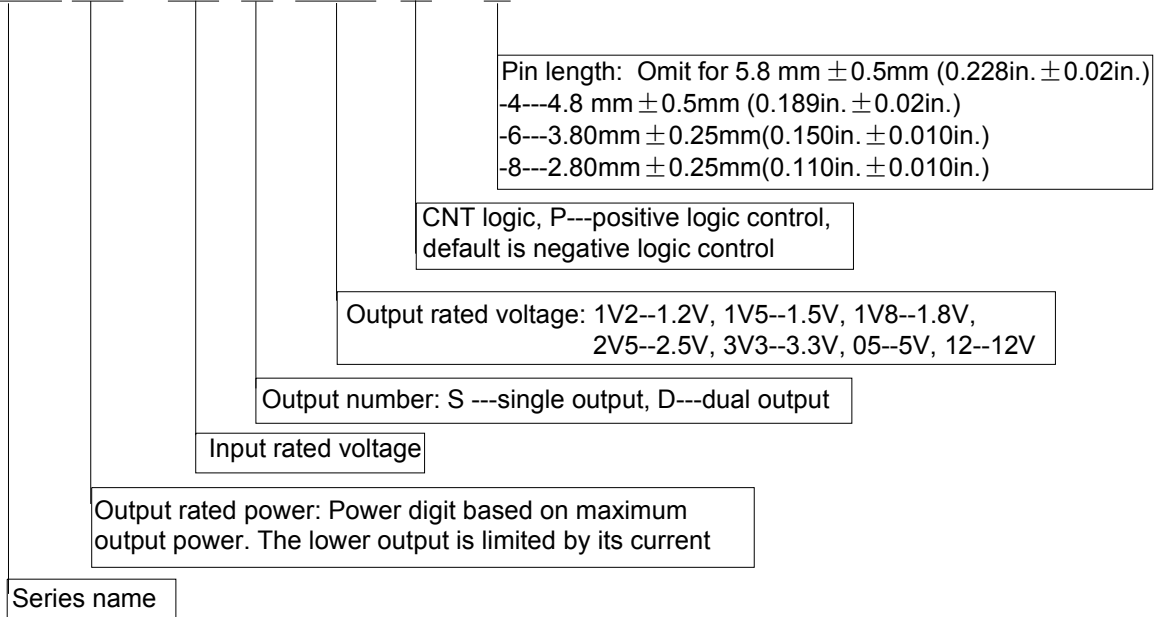

## Electrical Specifications

Unless otherwise indicated, specifications apply over all operating input voltage and temperature conditions. Standard test condition on a single converter is as follows:

Tc (board): 25 °C  
 +Vin: 48V ± 2%  
 -Vin: return pin for +Vin  
 CNT: connected to -Vin for negative logic  
       open for positive logic  
 +Vout: connected to load  
 -Vout: connected to load (return)  
 +Sense: connected to +Vout  
 -Sense: connect edto -Vout  
 Trim(Vadj): open

### Input Specifications

Parameter	Symbol	Min	Typ	Max	Unit
Operating Input Voltage	$V_I$	36	48	75	V <sub>DC</sub>
Maximum Input Current ( $V_I = 0$ to $V_{I,max}$ , $I_o = I_{o,max}$ )	$I_{I,max}$	-	-	2.5	A
Input Reflected-ripple Current (5Hz to 20MHz, 12uH source impedance, $T_A = 25$ °C)	$I_I$	-	-	20	mAp-p
Supply Voltage Rejection (1kHz)	-	50	60	-	dB

CAUTION: The converters have no internal fuse. An input line fuse must always be used.

## Absolute Maximum Ratings

Stresses in excess of the absolute maximum ratings can cause permanent damage to the device. These are absolute stress ratings only. Functional operation of the device is not implied at these or any other conditions in excess of those given in the operational sections of the IPS. Exposure to absolute maximum ratings for extended periods can adversely affect device reliability.

Parameter		Device	Symbol	Min	Typ	Max	Unit
Input Voltage	Continuous	All	$V_I$	0	-	75	Vdc
	Transient (100ms)	All	$V_{I,trans}$	0	-	100	Vdc
Operating Ambient Temperature (See Thermal Consideration)		All	$T_a$	-40	-	85	°C
Operating Board Temperature		All	$T_c$	-	-	100	°C
Storage Temperature		All	$T_{STG}$	-55	-	125	°C
Operating Humidity		All	-	-	-	85	%
Basic Input-Output Isolation (Conditions: 1mA for 60 sec, slew rate of 1500V/10sec)		All	-			2000	Vdc
Output Power	1.2V		$P_{o,max}$	0	-	24	W
	1.5V	30					
	1.8V	36					
	2.5V	50					
	3.3V	49.5					
	5V	50					
	12V	50					

## Output Specifications

Parameter	Device	Symbol	Min	Typ	Max	Unit
Output Ripple and Noise Peak-to-Peak (5Hz to 20 MHz) (Across 1 $\mu$ F @10V, X7R ceramic capacitor & 470 $\mu$ F @10V LOW ESR Aluminum capacitor)	1.2V			50		mVp-p
	1.5V			55		
	1.8V			45		
	2.5V	-	-	50	-	
	3.3V			50		
	5V			55		
	12V			55		
External Load Capacitance	1.2V				10,000	$\mu$ F
	1.5V				10,000	
	1.8V				10,000	
	2.5V	-	220	470	10,000	
	3.3V				10,000	
	5V				5000	
	12V				1000	
Output Voltage Setpoint (VI = VI,min to VI,max: Io = Io,max; Ta = 25 °C )	1.2V		1.18	1.2	1.22	Vdc
	1.5V		1.48	1.5	1.52	
	1.8V		1.77	1.8	1.83	
	2.5V	V <sub>o,set</sub>	2.46	2.5	2.54	
	3.3V		3.25	3.3	3.35	
	5V		4.95	5	5.05	
	12V		11.85	12	12.15	

Parameter		Device	Symbol	Min	Typ	Max	Unit	
Output Regulation	Line ( $V_{i,min}$ to $V_{i,max}$ )	1.2V			1		mV	
		1.5V			1			
		1.8V			1			
		2.5V	-	-	1	-		
		3.3V			1			
		5V			4			
	12V			9				
	Load ( $I_{o,min}$ to $I_{o,max}$ )	1.2V				1		mV
		1.5V				1		
1.8V					1			
2.5V		-	-	1	-			
3.3V				1				
5V				5				
12V			5					
Temperature ( $T_c = -40^{\circ}C$ to $+100^{\circ}C$ )		All	-	-	-	0.02	%Vo/°C	
Rated Output Current		1.2V, 1.5V 1.8V 2.5V 3.3V 5V 12V	$I_o$	0	-	20 20 20 20 15 10 4.2	A	
Output Current-limit Inception (Hiccup)		1.2V 1.5V 1.8V 2.5V 3.3V 5V 12V	$I_o$	22 22 22 22 16.5 11 4.6	-	28 28 28 28 21 14 7.0	A	

Parameter	Device	Symbol	Min	Typ	Max	Unit
Efficiency ( $V_I = V_{I,nom}$ ; $100\%I_{o,max}$ ; $T_A = 25^\circ C$ )	1.2V			88		%
	1.5V			87		
	1.8V			89		
	2.5V	-	-	90	-	
	3.3V			91		
	5V			91		
	12V			91		
Efficiency ( $V_I = V_{I,nom}$ ; $50\%I_{o,max}$ ; $T_A = 25^\circ C$ )	1.2V			86		%
	1.5V			86		
	1.8V			88		
	2.5V	-	-	88	-	
	3.3V			91		
	5V			90		
	12V			89		

### Output Specifications (Cont)

Parameter	Device	Symbol	Min	Typ	Max	Unit	
Dynamic Response ( $\Delta I_o/\Delta t = 1A/10\mu s$ , $V_I = V_{I,nom}$ ; $T_a = 25^\circ C$ )	1.2V			60		mV	
	1.5V			60			
	1.8V			40			
	2.5V	-	-	50	-		
	3.3V			95			
	5V			100			
	12V			150			
	Peak Deviation Settling Time (to $V_{o,nom}$ )	1.2V			300		μsec
		1.5V			110		
		1.8V			105		
		2.5V	-	-	60	-	
		3.3V			60		
		5V			120		
		12V			120		

Parameter		Device	Symbol	Min	Typ	Max	Unit	
Dynamic Response ( $\Delta I_o/\Delta t = 1A/1\mu s$ ; $V_I = V_{I,nom}$ ; $T_A = 25^\circ C$ , additional 220 $\mu F$ load capacitor)	Load Change from $I_o = 50\%$ to $75\%$ to $50\% I_{o,max}$	1.2V			130		mv	
		1.5V			130			
		1.8V			110			
		2.5V	-		150	-		
		3.3V			130			
		5V			130			
		12V			180			
	Peak Deviation Settling Time (to $V_{o,nom}$ )	1.2V				300		$\mu sec$
		1.5V				100		
		1.8V				110		
		2.5V	-		130	-		
		3.3V			80			
		5V			130			
		12V			300			
Turn-On Time ( $I_o = I_{o,max}$ ; $V_o$ within 1%)		All	-	-	-	20	msec	
Output Voltage Overshoot ( $I_o = I_{o,max}$ ; $T_A = 25^\circ C$ )		All	-	-	0		% $V_o$	
Switching Frequency		All	-		310		kHz	



## Feature Specifications

Parameter		Device	Symbol	Min	Typ	Max	Unit
Enable pin voltage	Logic Low	All		-0.7	-	1.2	V
	Logic High	All		3.5	-	12	V
Enable pin current (leakage current, @10V)	Logic Low	All		-	-	1.0	mA
	Logic High	All		-	-	-	μA
Output Voltage Adjustment Range		All*	-	80		110	%Vo
Output Over-voltage (Hiccup)		1.2V 1.5V 1.8V 2.5V 3.3V 5V 12V	V <sub>Oclamp</sub>	1.4 1.8 2.2 3.0 3.9 6.0 14.4	-	2.0 2.5 3.0 3.8 5.0 7.5 18	V
Over-temperature Protection (Auto-recovery)		All		110	120	135	C
Under-voltage Lockout	Turn-on Point	All	-	31	34	36	V
	Turn-off Point	All	-	30	33	35	V
Isolation Capacitance		All	-	-	1000	-	PF
Isolation Resistance		All	-	10	-	-	MΩ
Calculated MTBF (I <sub>o</sub> = I <sub>o,max</sub> ; T <sub>c</sub> = 25°C)		All	-	-	2,500,000	-	Hours
Weight		All	-	-	-	30	g(oz.)

Output Voltage Adjustment Rang of 12V converter is 90% to 110%.

## Characteristic Curves

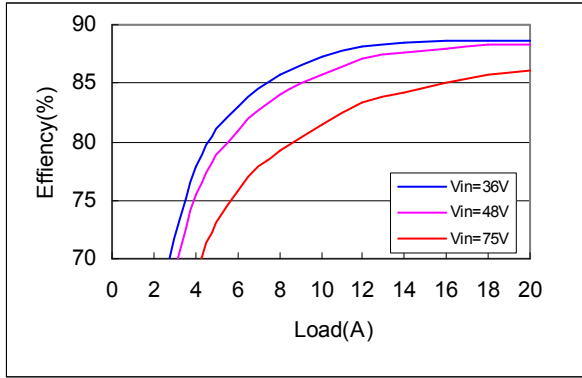

Fig.1 Typical efficiency of AVO50-48S1V2

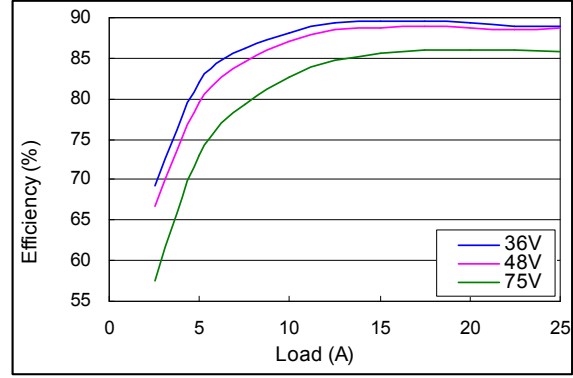

Fig.2 Typical efficiency of AVO50-48S1V5

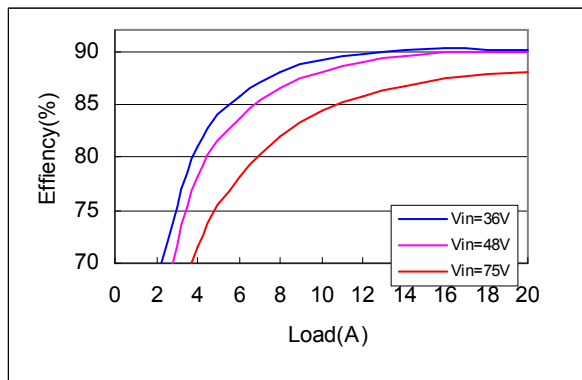

Fig.3 Typical efficiency of AVO50-48S1V8

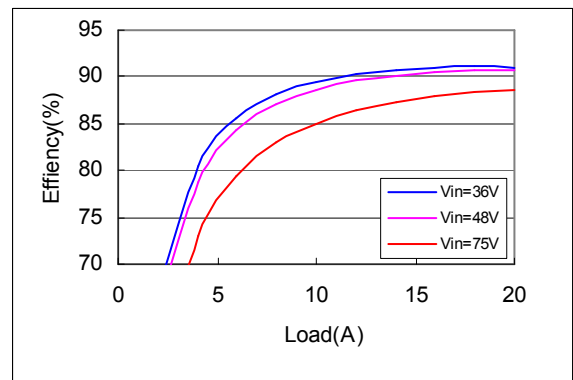

Fig.4 Typical efficiency of AVO50-48S2V5

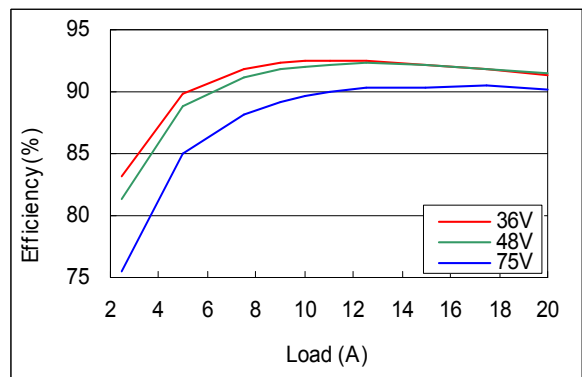

Fig.5 Typical efficiency of AVO50-48S3V3

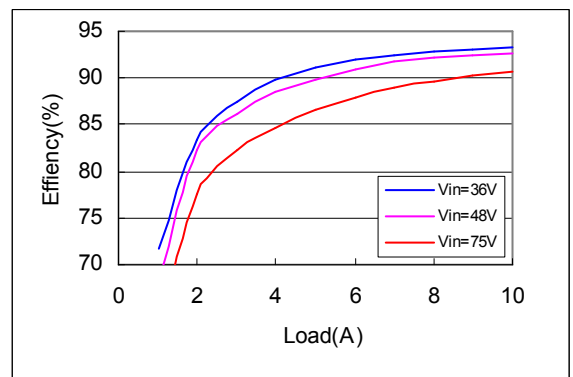

Fig.6 Typical efficiency of AVO50-48S05

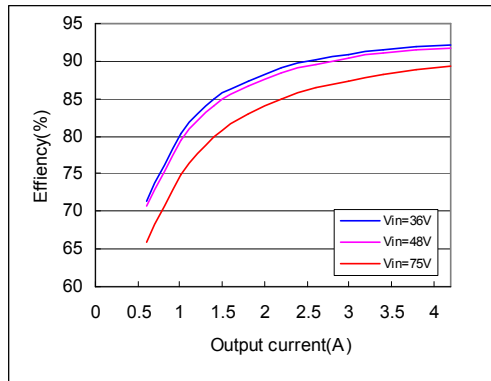

Fig.7 Typical efficiency of AVO50-48S12

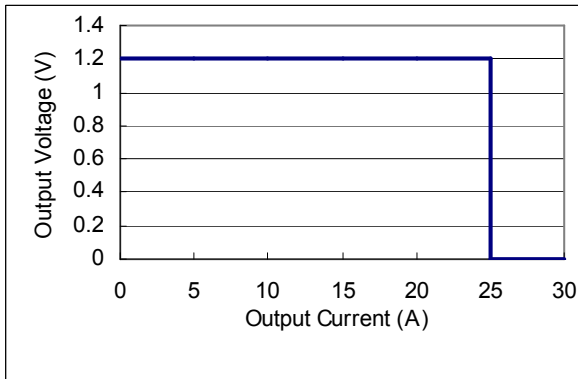

Fig.8 Typical output over-current of AVO50-48S1V2

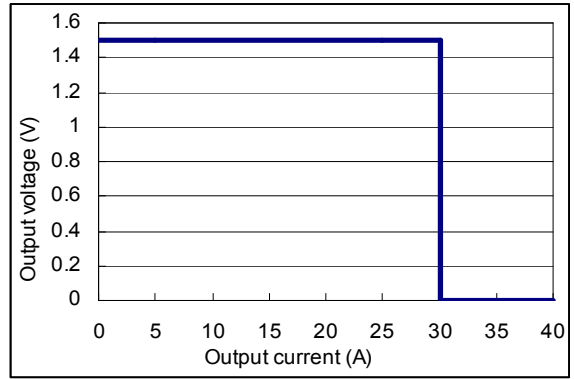

Fig.9 Typical output over-current of AVO50-48S1V5

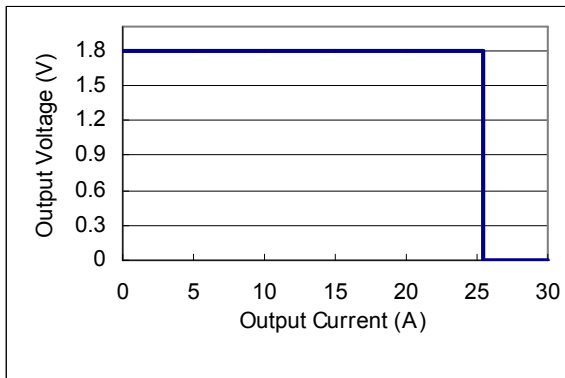

Fig.10 Typical output over-current of AVO50-48S1V8

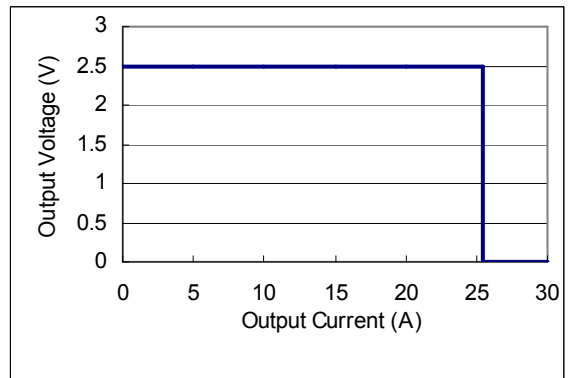

Fig.11 Typical output over-current of AVO50-48S2V5

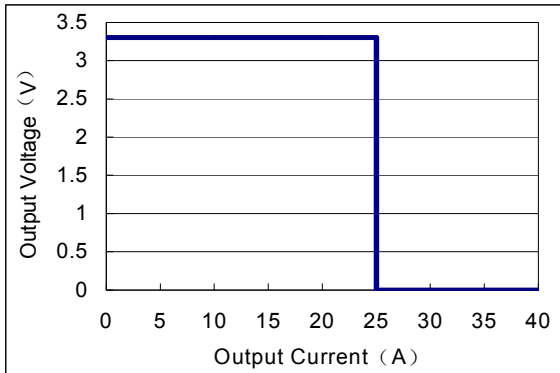

Fig.12 Typical output over-current of AVO50-48S3V3

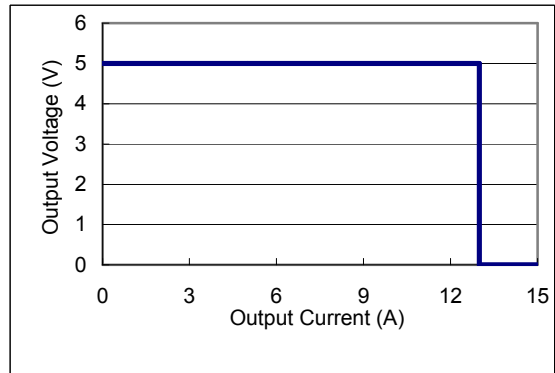

Fig.13 Typical output over-current of AVO50-48S05

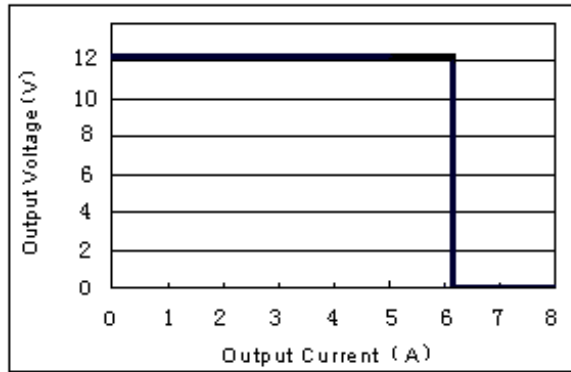

Fig.14 Typical output over-current of AVO50-48S12

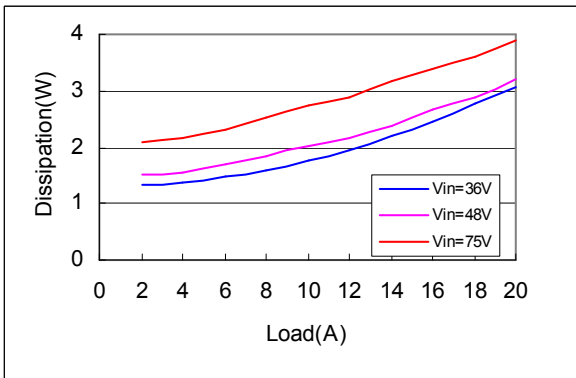

Fig.15 Typical power dissipation of AVO50-48S1V2

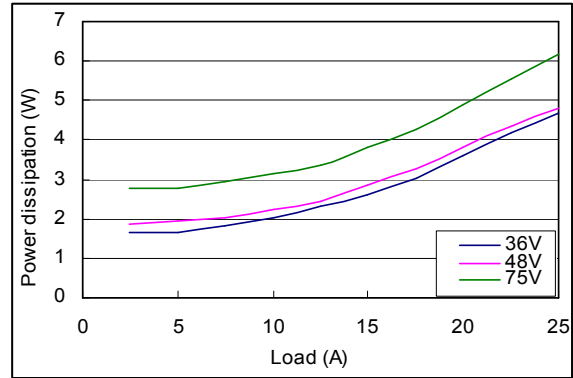

Fig.16 Typical power dissipation of AVO50-48S1V5

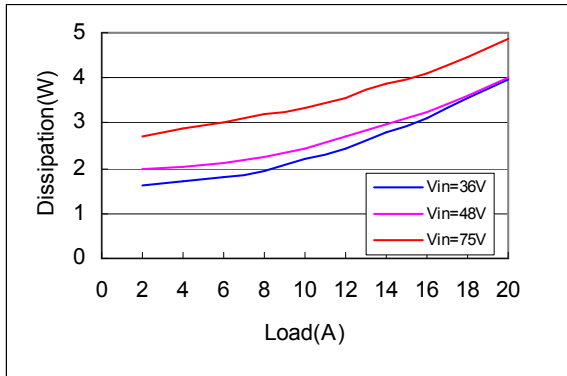

Fig.17 Typical power dissipation of AVO50-48S1V8

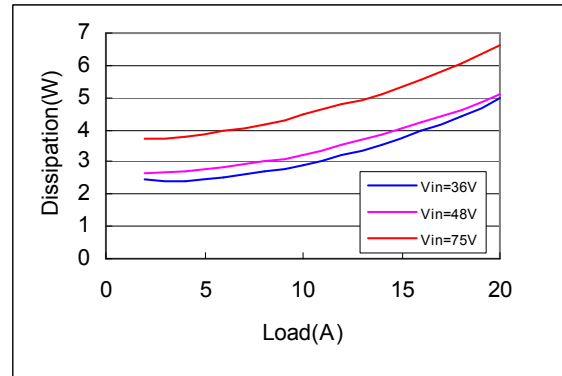

Fig.18 Typical power dissipation of AVO50-48S2V5

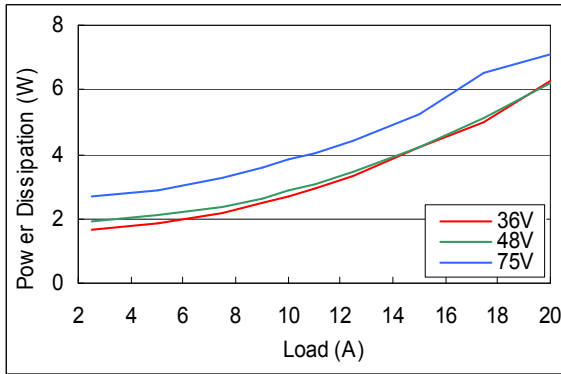

Fig.19 Typical power dissipation of AVO50-48S3V3

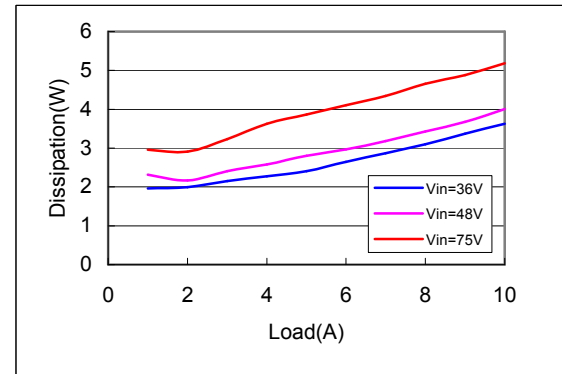

Fig.20 Typical power dissipation of AVO50-48S05

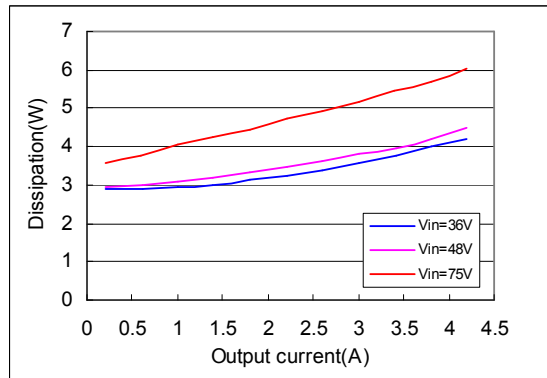

Fig.21 Typical power dissipation of AVO50-48S12

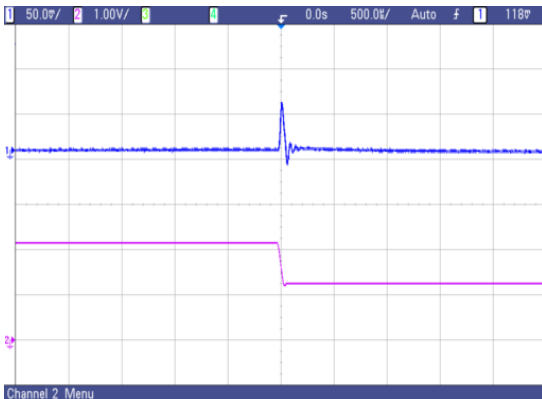

Fig.22 AVO50-48S1V2 typical transient response to step decrease in load from 50% to 25% of full load, room temperature, 48Vdc input ( $\Delta I_o/\Delta t = 0.1A/1\mu s$ )

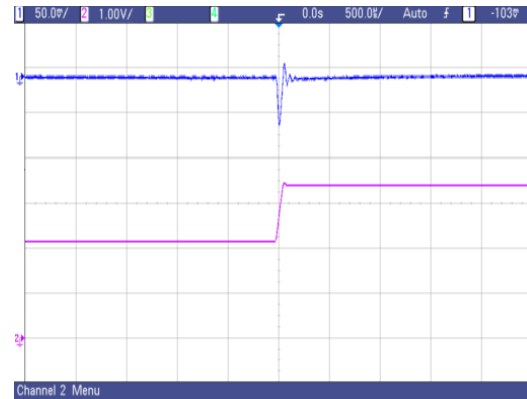

fig.23 AVO50-48s1V2 typical transient response to step increase in load from 50% to 75% of full load, room temperature, 48Vdc input ( $\Delta I_o/\Delta t = 0.1A/1\mu s$ )



Fig.24 AVO50-48S1V5 typical transient response to step decrease in load from 50% to 25% of full load, room temperature, 48Vdc input ( $\Delta I_o/\Delta t = 1A/1\mu s$ )

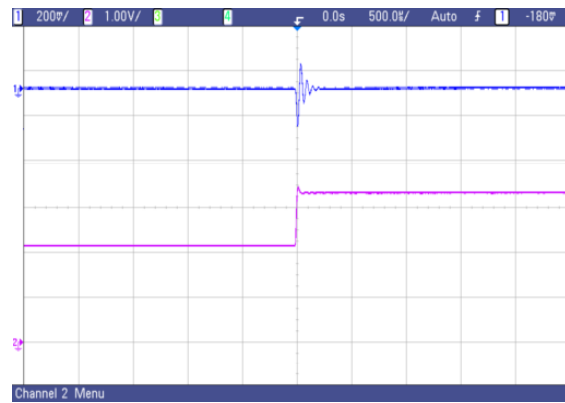

Fig.25 AVO50-48S1V5 typical transient response to step increase in load from 50% to 75% of full load, room temperature, 48Vdc input ( $\Delta I_o/\Delta t = 1A/1\mu s$ )

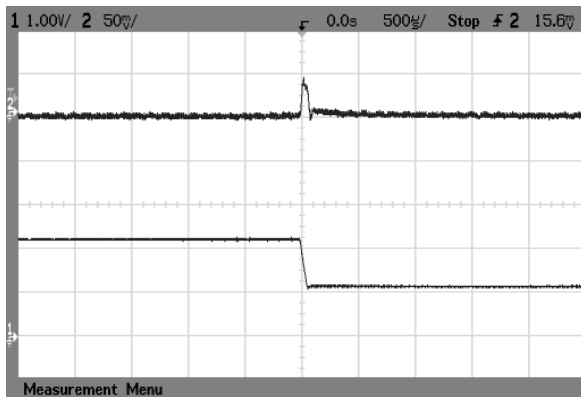

Fig.26 AVO50-48S1V5 typical transient response to step decrease in load from 50% to 25% of full load, room temperature, 48Vdc input ( $\Delta I_o/\Delta t = 0.1A/1\mu s$ )

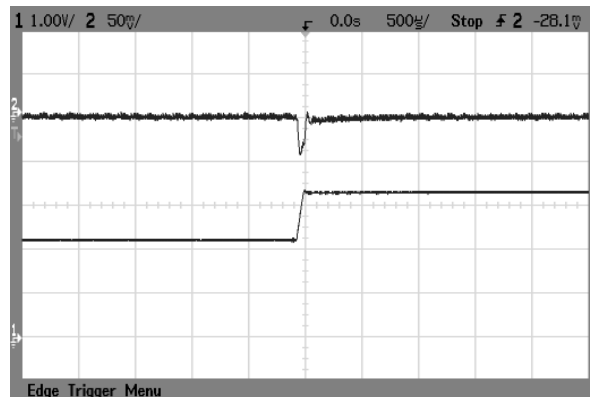

Fig.27 AVO50-48S1V5 typical transient response to step increase in load from 50% to 75% of full load, room temperature, 48Vdc input ( $\Delta I_o/\Delta t = 0.1A/1\mu s$ )

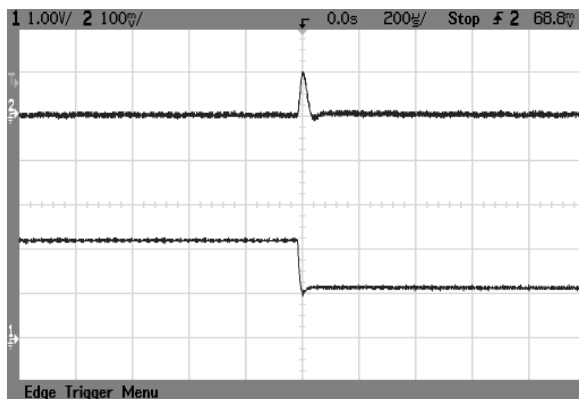

Fig.28 AVO50-48S1V5 typical transient response to step decrease in load from 50% to 25% of full load, room temperature, 48Vdc input ( $\Delta I_o/\Delta t = 1A/1\mu s$ )

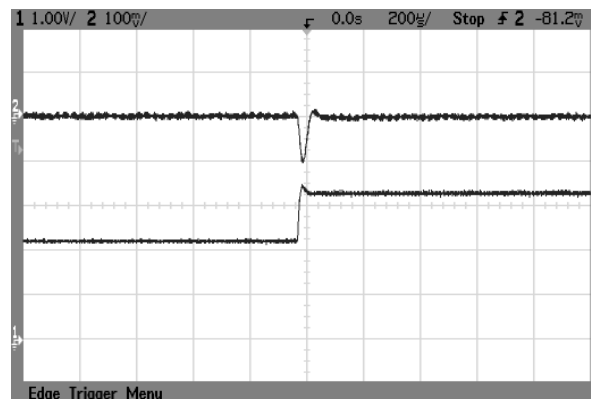

Fig.29 AVO50-48S1V5 typical transient response to step increase in load from 50% to 75% of full load, room temperature, 48Vdc input ( $\Delta I_o/\Delta t = 1A/1\mu s$ )

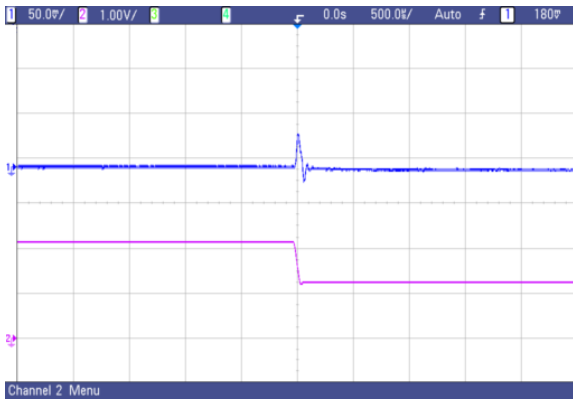

Fig.30 AVO50-48S1V8 typical transient response to step decrease in load from 50% to 25% of full load, room temperature, 48Vdc input ( $\Delta I_o/\Delta t = 0.1A/1\mu s$ )

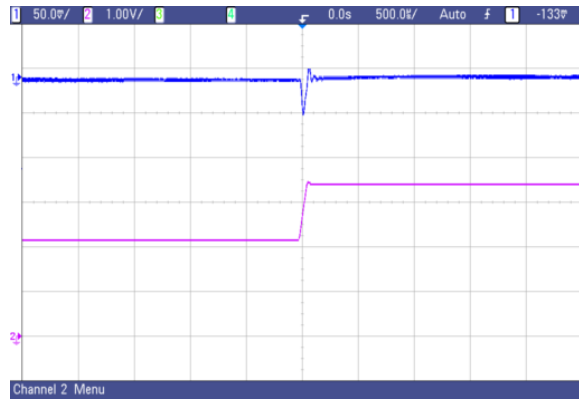

Fig. 31 AVO50-48S1V8 typical transient response to step increase in load from 50% to 75% of full load, room temperature, 48Vdc input ( $\Delta I_o/\Delta t = 0.1A/1\mu s$ )

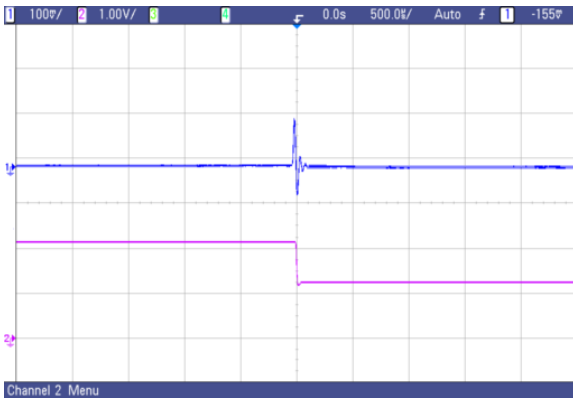

Fig.32 AVO50-48S1V8 typical transient response to step decrease in load from 50% to 25% of full load, room temperature, 48Vdc input ( $\Delta I_o/\Delta t = 1A/1\mu s$ )



Fig.33 AVO50-48S1V8 typical transient response to step increase in load from 50% to 75% of full load, room temperature, 48Vdc input ( $\Delta I_o/\Delta t = 1A/1\mu s$ )



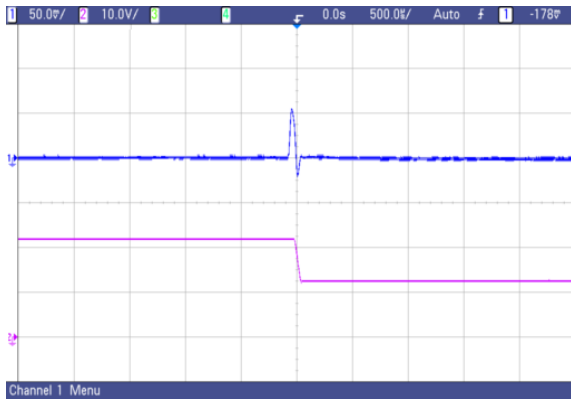

Fig.34 AVO505-48S2V5 typical transient response to step decrease in load from 50% to 25% of full load, room temperature, 48Vdc input ( $\Delta I_o/\Delta t = 0.1A/1\mu s$ )

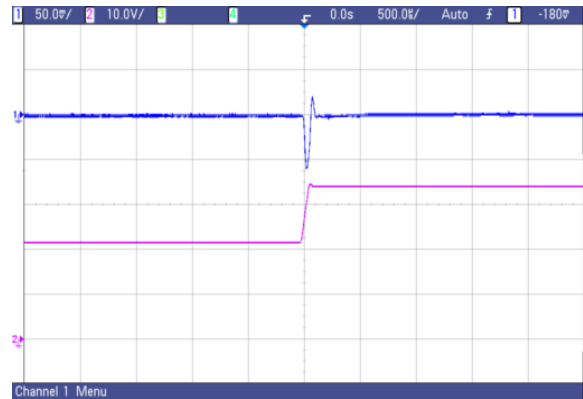

Fig. 35 AVO50-48S2V5 typical transient response to step increase in load from 50% to 75% of full load, room temperature, 48Vdc input ( $\Delta I_o/\Delta t = 0.1A/1\mu s$ )

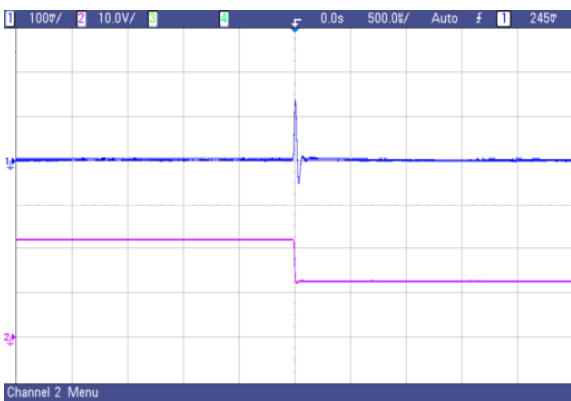

Fig.36 AVO505-48S2V5 typical transient response to step decrease in load from 50% to 25% of full load, room temperature, 48Vdc input ( $\Delta I_o/\Delta t = 1A/1\mu s$ )

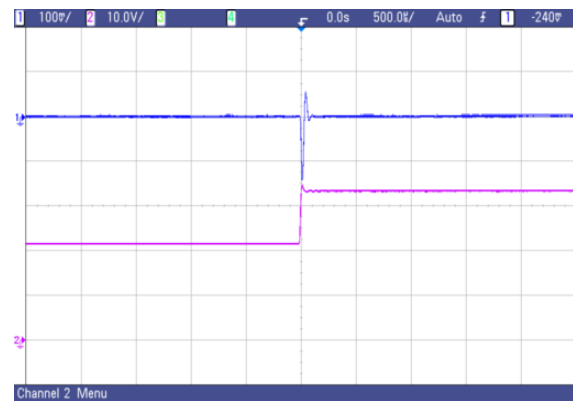

Fig.37 AVO50-48S2V5 typical transient response to step increase in load from 50% to 75% of full load, room temperature, 48Vdc input ( $\Delta I_o/\Delta t = 1A/1\mu s$ )

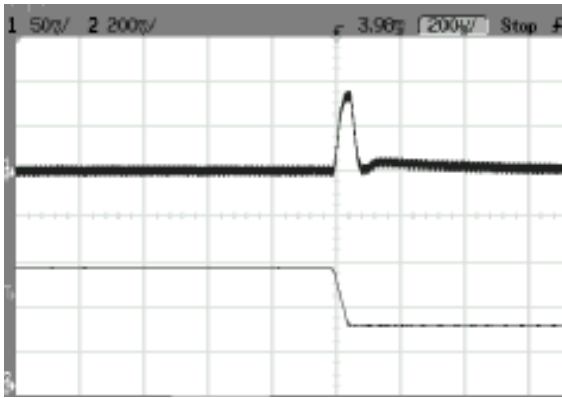

Fig.38 AVO50-48S3V3 typical transient response to step decrease in load from 50% to 25% of full load, room temperature, 48Vdc input ( $\Delta I_o/\Delta t = 0.1A/1\mu s$ )

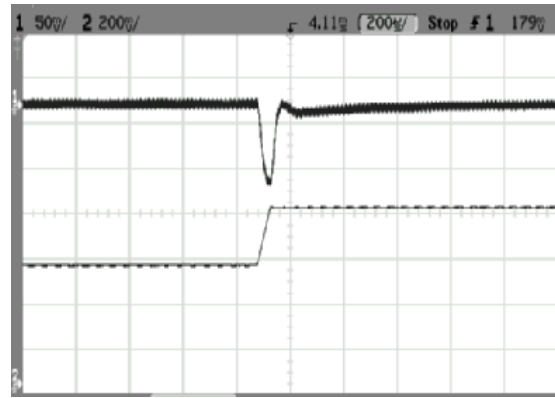

Fig. 39 AVO50-48S3V3 typical transient response to step increase in load from 50% to 75% of full load, room temperature, 48Vdc input ( $\Delta I_o/\Delta t = 0.1A/1\mu s$ )

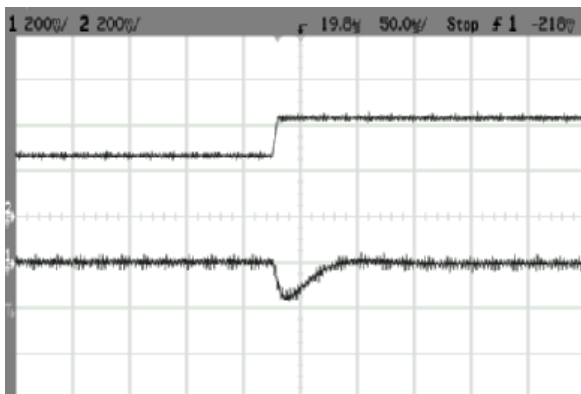

Fig.40 AVO50-48S3V3 typical transient response to step decrease in load from 50% to 25% of full load, room temperature, 48Vdc input ( $\Delta I_o/\Delta t = 1A/1\mu s$ )

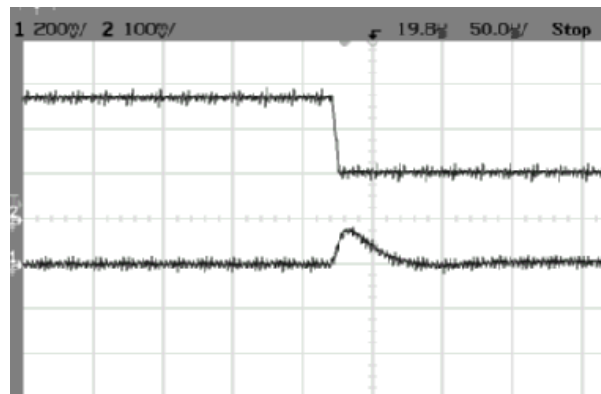

Fig.41 AVO50-48S3V3 typical transient response to step increase in load from 50% to 75% of full load, room temperature, 48Vdc input ( $\Delta I_o/\Delta t = 1A/1\mu s$ )

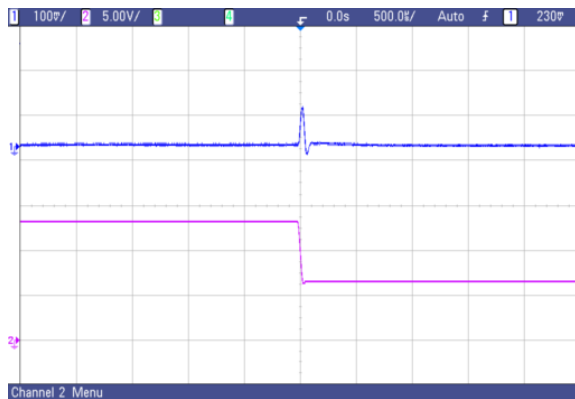

Fig.42 AVO50-48S05 typical transient response to step decrease in load from 50% to 25% of full load, room temperature, 48Vdc input ( $\Delta I_o/\Delta t = 0.1A/1\mu s$ )

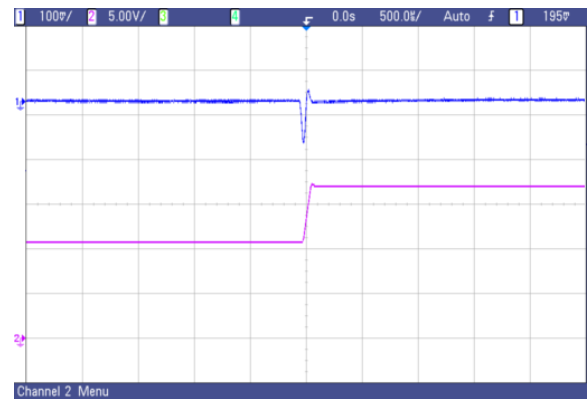

Fig. 43 AVO50-48S05 typical transient response to step increase in load from 50% to 75% of full load, room temperature, 48Vdc input ( $\Delta I_o/\Delta t = 0.1A/1\mu s$ )

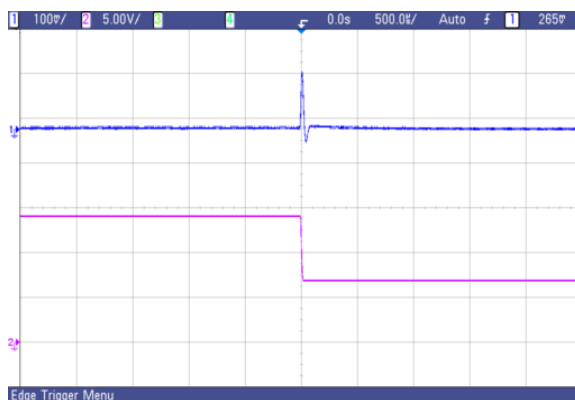

Fig.44 AVO50-48S05 typical transient response to step decrease in load from 50% to 25% of full load, room temperature, 48Vdc input ( $\Delta I_o/\Delta t = 1A/1\mu s$ )

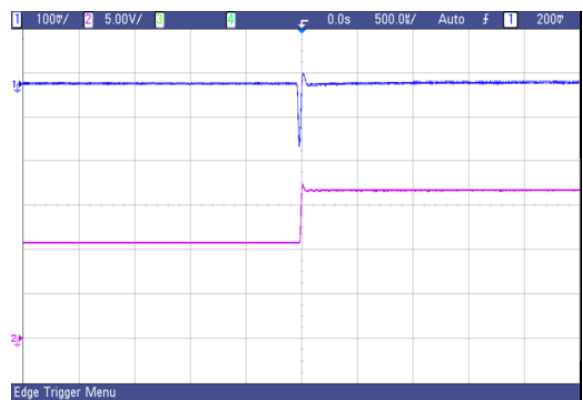

Fig.45 AVO50-48S05 typical transient response to step increase in load from 50% to 75% of full load, room temperature, 48Vdc input ( $\Delta I_o/\Delta t = 1A/1\mu s$ )

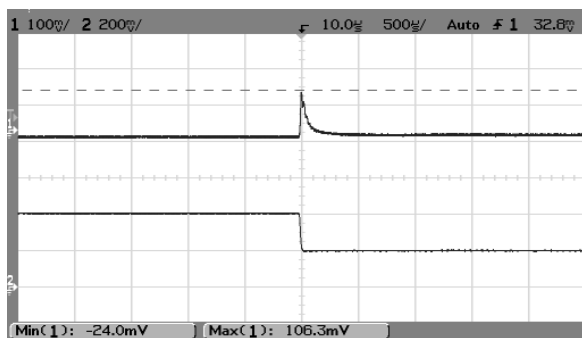

Fig.46 AVO50-48S12 typical transient response to step decrease in load from 50% to 25% of full load, room temperature, 48Vdc input ( $\Delta I_o/\Delta t = 0.1A/1\mu s$ )

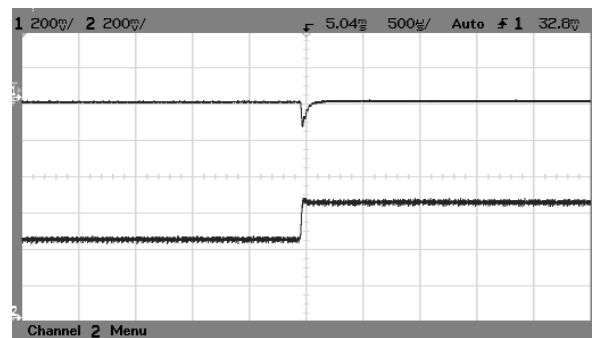

Fig. 47 AVO50-48S12 typical transient response to step increase in load from 50% to 75% of full load, room temperature, 48Vdc input ( $\Delta I_o/\Delta t = 0.1A/1\mu s$ )

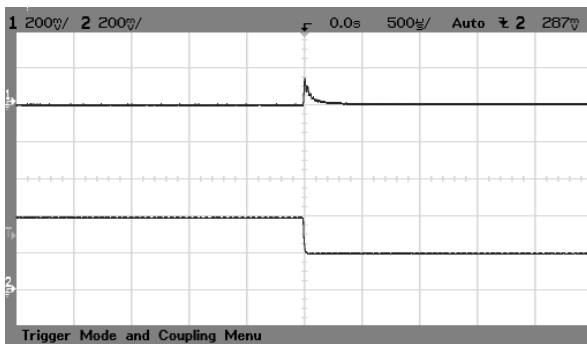

Fig.48 AVO50-48S12 typical transient response to step decrease in load from 50% to 25% of full load, room temperature, 48Vdc input ( $\Delta I_o/\Delta t = 1A/1\mu s$ )

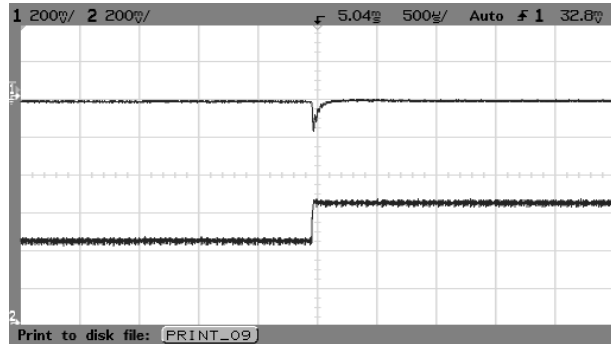

Fig.49 AVO50-48S12 typical transient response to step increase in load from 50% to 75% of full load, room temperature, 48Vdc input ( $\Delta I_o/\Delta t = 1A/1\mu s$ )

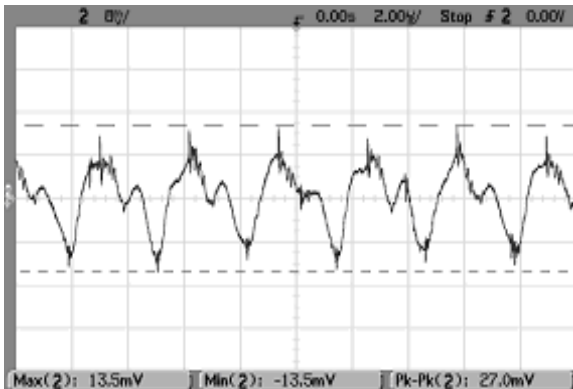

Fig.50 Typical output ripple voltage of AVO50-48S1V2 room temperature,  $I_o = I_{o,max}$

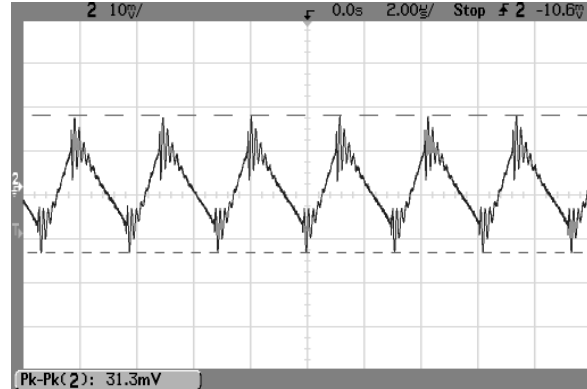

Fig.51 Typical output ripple voltage of AVO50-48S1V5 room temperature,  $I_o = I_{o,max}$

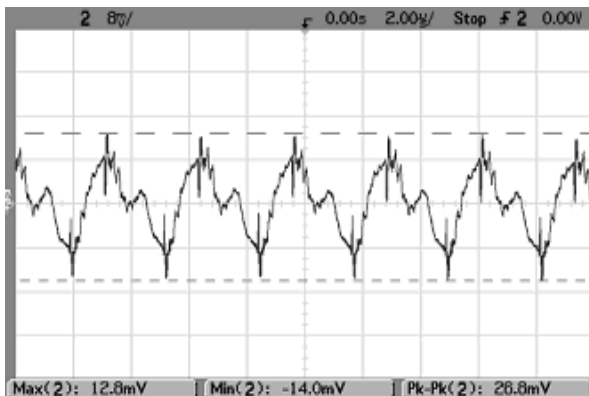

Fig.52 Typical output ripple voltage of AVO50-48S1V8 room temperature,  $I_o = I_{o,max}$

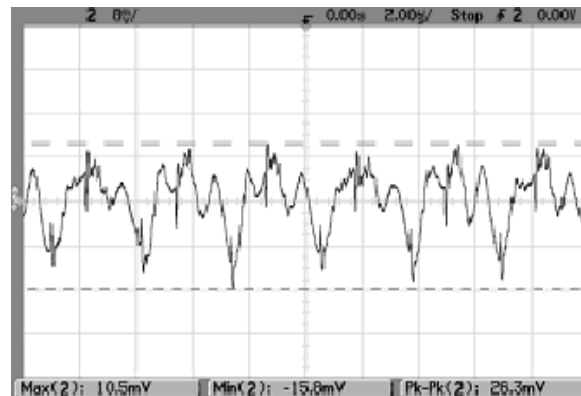

Fig.53 Typical output ripple voltage of AVO50-48S2V5 room temperature,  $I_o = I_{o,max}$

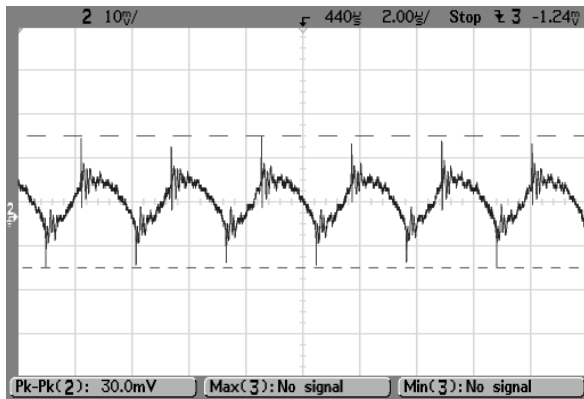

Fig.54 Typical output ripple voltage of AVO50-48S3V3  
room temperature,  $I_o = I_{o,max}$

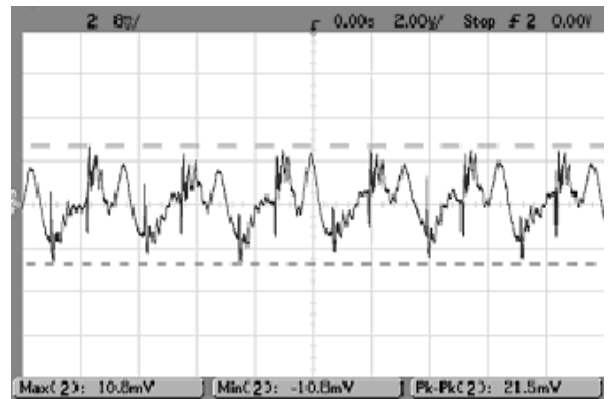

Fig.55 Typical output ripple voltage of AVO50-48S05  
room temperature,  $I_o = I_{o,max}$

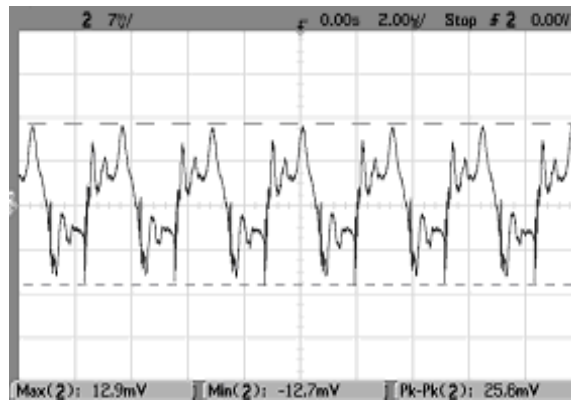

Fig.56 Typical output ripple voltage of AVO50-48S12  
room temperature,  $I_o = I_{o,max}$

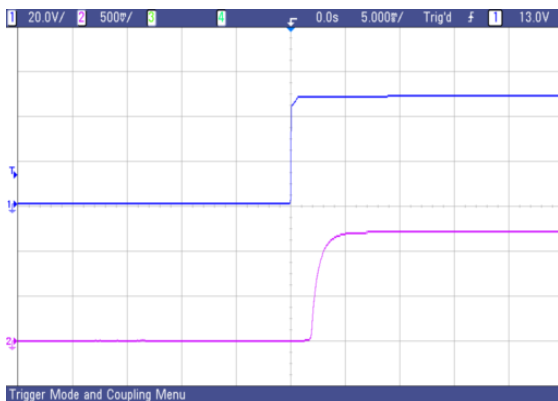

Fig.57 AVO50-48S1V2 typical start-up from power on

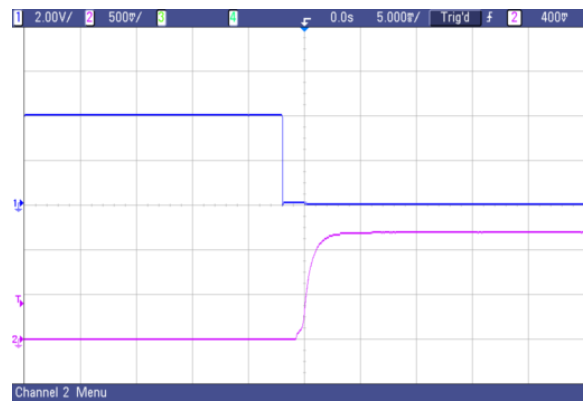

Fig.58 AVO50-48S1V2 typical start-up from CNT on

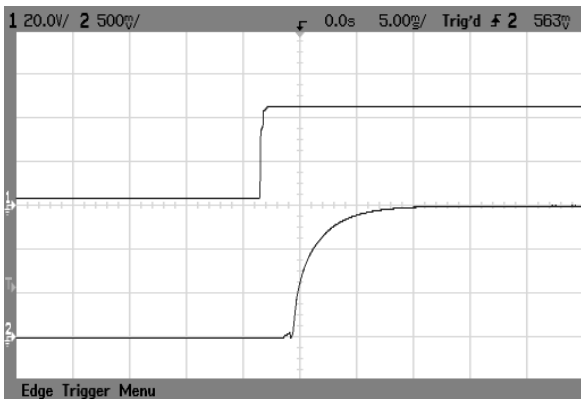

Fig.59 AVO50-48S1V5 typical start-up from power on

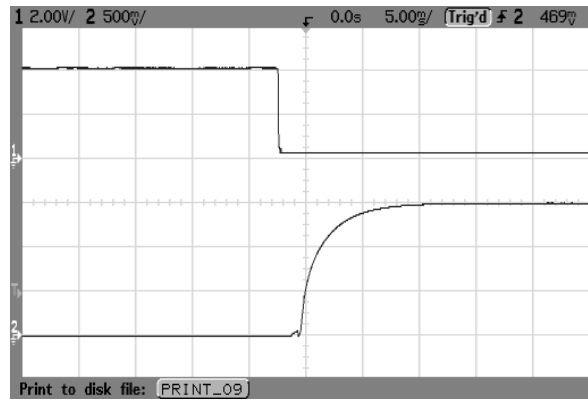

Fig.60 AVO50-48S1V5 typical start-up from CNT on



Fig.61 AVO50-48S1V8 typical start-up from power on



Fig.62 AVO50-48S1V8 typical start-up from CNT on

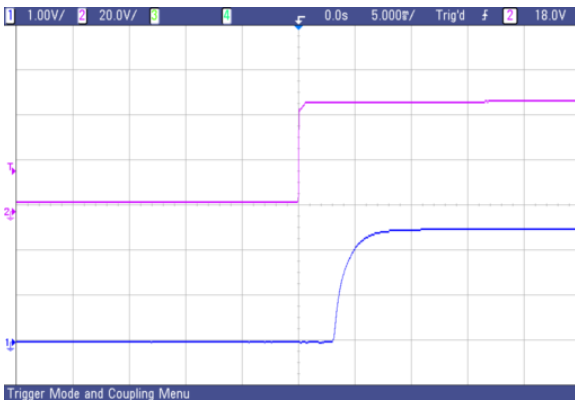

Fig.63 AVO50-48S2V5 typical start-up from power on



Fig.64 AVO50-48S2V5 typical start-up from CNT on

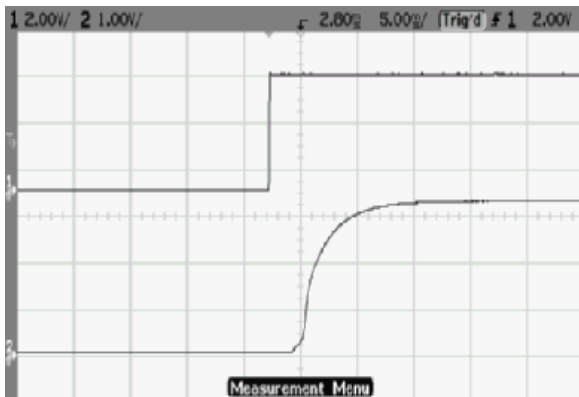

Fig.65 AVO50-48S3V3 typical start-up from power on

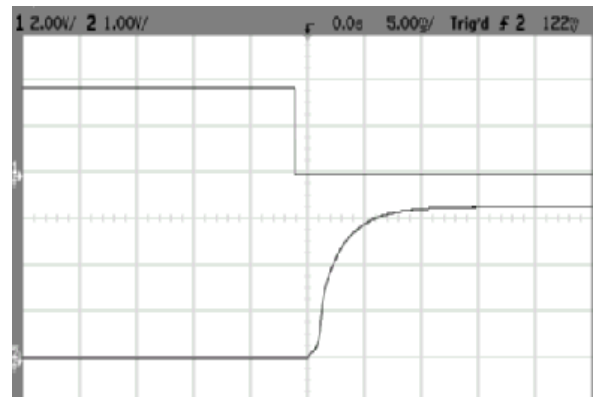

Fig.66 AVO50-48S3V3 typical start-up from CNT on

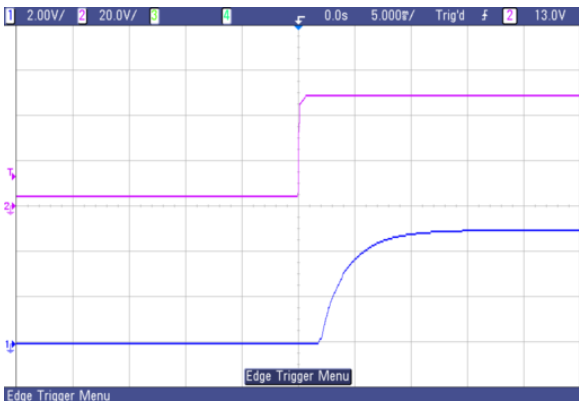

Fig.67 AVO50-48S05 typical start-up from power on

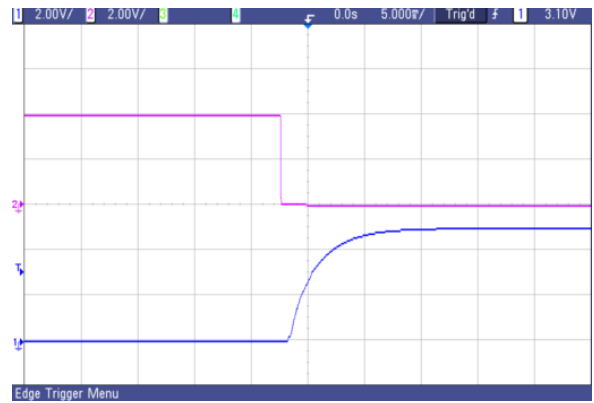

Fig.68 AVO50-48S05 typical start-up from CNT on

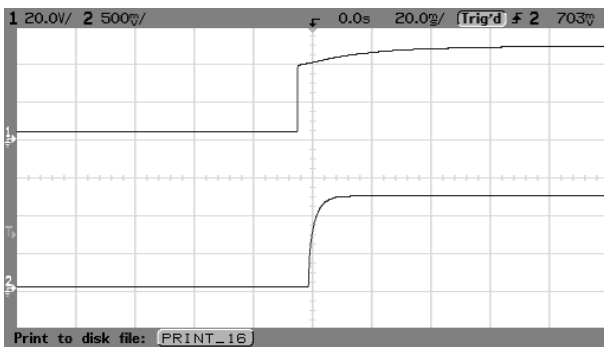

Fig.69 AVO50-48S12 typical start-up from power on

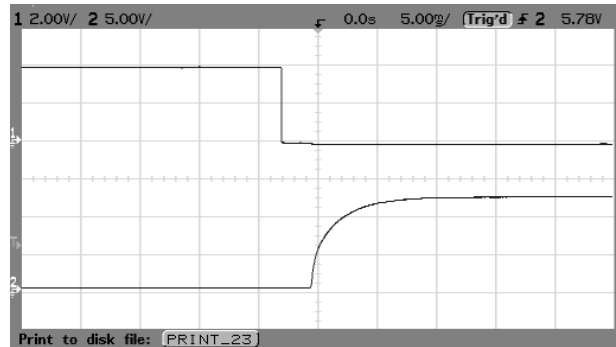

Fig.70 AVO50-48S12 typical start-up from CNT on

# Feature Description

## CNT Function

The converter is equipped with a primary ON/OFF pin used to remotely turn the converter on or off via a system signal. Two CNT logic options are available. For the positive logic model a system logic low signal will turn the converter off. For the negative logic model a system logic high signal will turn the converter off. For negative logic models where no control signal will be used the ON/OFF pin should be connected directly to  $-V_{in}$  to ensure proper operation. For positive logic models where no control signal will be used the ON/OFF pin should be left unconnected.

The following figure shows a few simple CNT circuits.

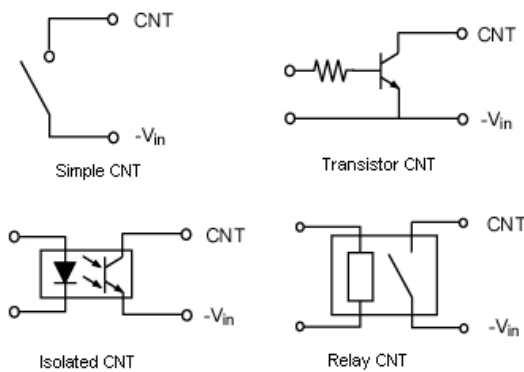

Fig.71 CNT circuits

## Remote Sense

The converter can remotely sense both lines of its output which moves the effective output voltage regulation point from the output terminals of the converter to the point of connection of the remote sense pins. This feature automatically adjusts the real output voltage of the converters in order to

compensate for voltage drops in distribution and maintain a regulated voltage at the point of load.

When the converter is supporting loads far away, or is used with undersized cabling, significant voltage drop can occur at the load. The best defense against such drops is to locate the load close to the converter and to ensure adequately sized cabling is used. When this is not possible, the converter can compensate for a drop of up to 10% $V_o$ , through use of the sense leads.

When used, the + Sense and - Sense leads should be connected from the converter to the point of load as shown in Fig.72, using twisted pair wire, or parallel pattern to reduce noise effect. The converter will then regulate its output voltage at the point where the leads are connected. Care should be taken not to reverse the sense leads. If reversed, the converter will trigger OVP protection.

When not used, the +Sense lead must be connected with  $+V_o$ , and -Sense with  $-V_o$ . Although the output voltage can be increased by both the remote sense and by the trim, the maximum increase for the output voltage is not the sum of both.

The maximum increase is the larger of either the remote sense or the trim.

Note that at elevated output voltages the maximum power rating of the converter remains the same, and the output current capability will decrease correspondingly.

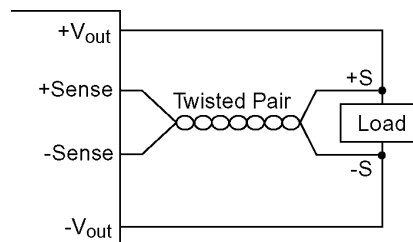

Fig.72 Sense connections



## Trim

The +Vo output voltage of the converter can be trimmed with the trim pin provided. Applying a resistor to the trim pin through a voltage divider from the output will cause the +Vo output to increase by up to 10% or decrease by up to 20%. Trimming up by more than 10% of the nominal output may activate the OVP circuit or damage the converter. Trimming down more than 20% can cause the converter to regulate improperly. If the trim pin is not needed, it should be left open.

### Trim up

With an external resistor connected between the TRIM and +SENSE pins, the output voltage set point increases (see Fig.73).

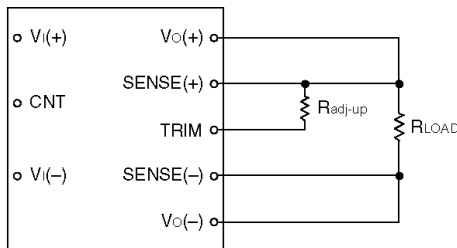

Fig.73 Trim up circuit

The following equation determines the required external-resistor value to obtain a percentage output voltage change of 1%.

For Output Voltage: 1.5V ~ 12V

$$R_{adj-up} = \frac{5.1 \times V_{nom} \times (100 + \Delta\%)}{1.225 \times \Delta\%} - \frac{510}{\Delta\%} - 10.2(K\Omega)$$

For Output Voltage: 1.2V

$$R_{adj-up} = \frac{5.1 \times V_{nom} \times (100 + \Delta\%)}{0.6 \times \Delta\%} - \frac{510}{\Delta\%} - 10.2(K\Omega)$$

**Note:**  $\Delta = (V_{nom} - V_o) \times 100 / V_{nom}$

V<sub>trim</sub> tolerance: <math>\pm 2\%</math>

R<sub>adj</sub> tolerance :  $\pm 1\%$

For example: to trim up the output of AVO75-48S1V8 to 1.98V:

$$\Delta = (1.98 - 1.8) \times 100 / 1.8 = 10$$

$$R_{adj-up} = \frac{5.1 \times 1.8 \times (100 + 10)}{1.225 \times 10} - \frac{510}{10} - 10.2(K\Omega)$$

$$R_{adj-up} = 21.23(K\Omega)$$

### Trim down

With an external resistor between the TRIM and -SENSE pins, the output voltage set point decreases (see Fig.74).

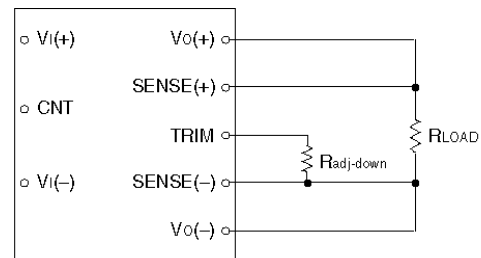

Fig.74 Trim down circuit

The following equation determines the required external-resistor value to obtain a percentage output voltage change of 1%.

For Output Voltage: 1.2V ~ 12V

$$R_{adj-down} = \frac{510}{\Delta\%} - 10.2(K\Omega)$$

**Note:**  $\Delta = (V_{nom} - V_o) \times 100 / V_{nom}$

V<sub>trim</sub> tolerance: <math>\pm 2\%</math>

R<sub>adj</sub> tolerance:  $\pm 1\%$

For example: to trim down the output to 1.62V,

$$\Delta = (1.8 - 1.62) \times 100 / 1.8 = 10$$

$$R_{adj-down} = \frac{510}{10} - 10.2(K\Omega)$$

$$R_{adj-down} = 40.8(K\Omega)$$

Although the output voltage can be increased by both the remote sense and by the trim, the maximum increase for the output voltage is not the sum of both. The maximum increase is the larger of either the remote sense or the trim.

Note that at elevated output voltages the maximum power rating of the converter

remains the same, and the output current capability will decrease correspondingly.

## Minimum Load Requirements

There is no minimum load requirement for the converter.

## Output Capacitance

High output current transient rate (high  $di/dt$ ) of change loads might require high values of output capacitance to supply the instantaneous energy requirement to the load. To minimize the output voltage transient drop during this transient, low Equivalent Series Resistance (ESR) capacitors may be required, since a high ESR will produce a correspondingly higher voltage drop during the current transient.

When the load is sensitive to ripple and noise, an output filter can be added to minimize the effects. A simple output filter to reduce output ripple and noise can be made by connecting a capacitor  $C_1$  across the output as shown in Fig.75. The recommended value for the output capacitor  $C_1$  is  $470\mu\text{F}$ .

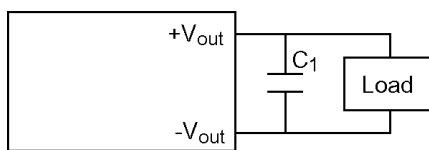

Fig.75 Output ripple filter

Extra care should be taken when long leads or traces are used to provide power to the load. Long lead lengths increase the chance for noise to appear on the lines. Under these conditions  $C_1$  can be added across the load, with a  $1\mu\text{F}$  ceramic capacitor  $C_2$  in parallel generally as shown in Fig.76.

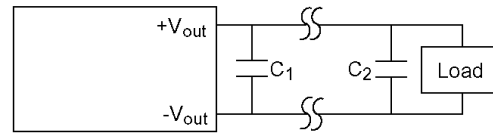

Fig.76 Output ripple filter for a distant load

## Decoupling

Noise on the power distribution system is not always created by the converter. High-speed analog or digital loads with dynamic power demands can cause noise to cross the power inductor back onto the input lines. Noise can be reduced by decoupling the load. In most cases, connecting a  $10\mu\text{F}$  tantalum or ceramic capacitor in parallel with a  $0.1\mu\text{F}$  ceramic capacitor across the load will decouple it. The capacitors should be connected as close to the load as possible.

## Ground Loops

Ground loops occur when different circuits are given multiple paths to common or earth ground, as shown in Fig.77. Multiple ground points can have slightly different potentials and cause current flow through the circuit from one point to another. This can result in additional noise in all the circuits. To eliminate the problem, circuits should be designed with a single ground connection as shown in Fig.78.

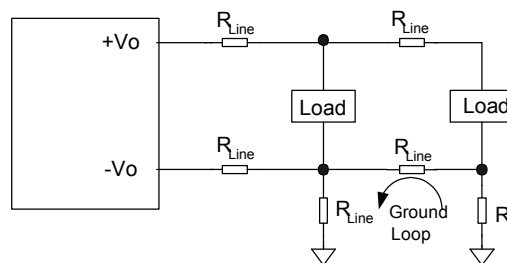

Fig.77 Ground loops

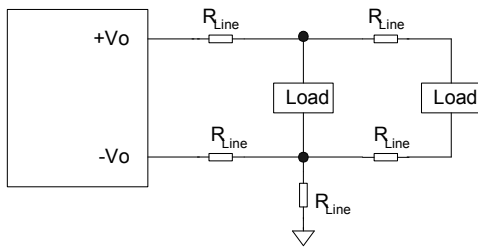

Fig.78 Single point ground

## Output Over-current Protection

The converter feature foldback current limiting as part of their Over-current Protection (OCP) circuits. When output current exceeds 110 to 140% of rated current, such as during a short circuit condition, the converter will work on intermittent mode, also can tolerate short circuit conditions indefinitely. When the over-current condition is removed, the converter will automatically restart.

## Output Over-Voltage Protection

The output over-voltage protection consists of circuitry that monitors the voltage on the output terminals. If the voltage on the output terminals exceeds the over voltage protection threshold, then the converter will work on intermittent mode. When the over-voltage condition is removed, the converter will automatically restart.

The protection mechanism is such that the converter can continue in this condition until the fault is cleared.

## Over-Temperature Protection

The converter features an over-temperature protection circuit to safeguard against thermal damage. The converter will work on intermittent mode when the maximum device reference temperature is exceeded. When the

over-temperature condition is removed, the converter will automatically restart.

# Design Consideration

## Typical Application

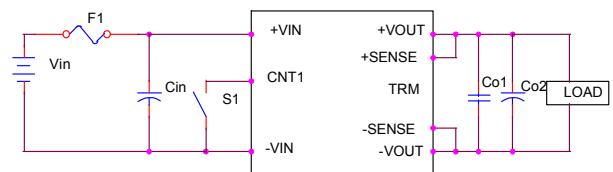

Fig.79 Typical application

F1: Fuse. Use external fuse with a rating of 5A (fast blow type) for each converter.

Cin: Recommended input capacitor. Use 47 $\mu$ F/100V high frequency low ESR electrolytic type capacitor.

Co1: Recommended 1 $\mu$ F /10V ceramic capacitor

Co2: Recommended output capacitor

Use 470 $\mu$ F/10V high frequency low ESR electrolytic type capacitor.

If  $T_a < -5^\circ\text{C}$ , use 220 $\mu$ F tantalum capacitor parallel with a 470 $\mu$ F/ 10V high frequency low ESR electrolytic capacitor.

Note: The converter cannot be used in parallel mode directly!

## Fusing

The converter has no internal fuse. An external fuse must always be employed! To meet international safety requirements, a 250 Volt rated fuse should be used. If one of the input lines is connected to chassis ground, then the fuse must be placed in the other input line.

Standard safety agency regulations require input fusing. Recommended fuse ratings is 5A.

Note: the fuse is fast blow type.

## Input Reverse Voltage Protection

Under installation and cabling conditions where reverse polarity across the input may occur, reverse polarity protection is recommended. Protection can easily be provided as shown in Fig.80. In both cases the diode used is rated for 10A/100V. Placing the diode across the inputs rather than in-line with the input offers an

advantage in that the diode only conducts in a reverse polarity condition, which increases circuit efficiency and thermal performance.

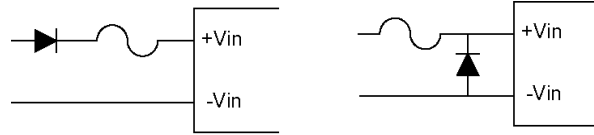

Fig.80 Reverse polarity protection circuit

## EMC

a filter designed to reduce EMI effects. The converter can meet EN55022 CLASSA.

For conditions where EMI is a concern, a different input filter can be used. Fig.81 shows

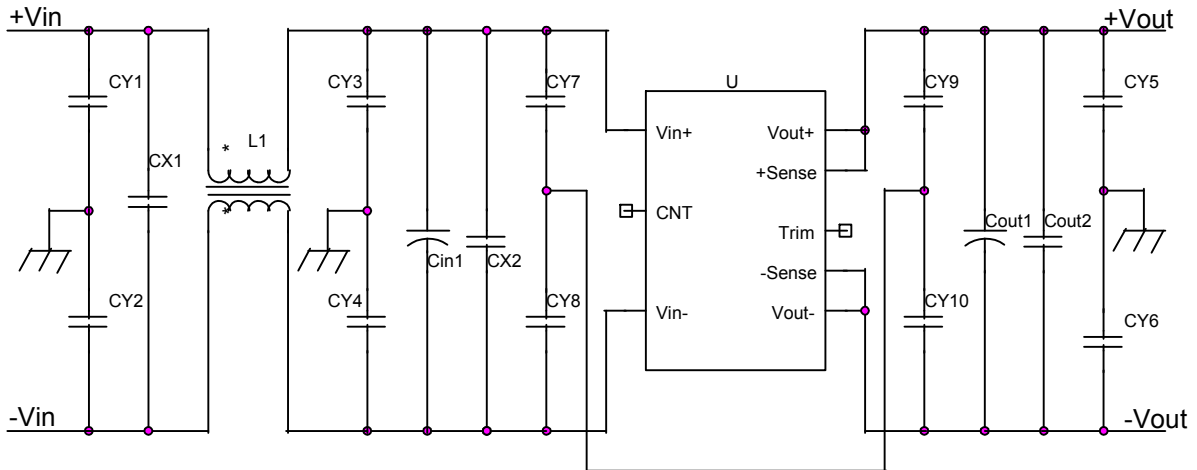

Fig.81 EMI reduction filter

Recommended values:

Component	Value/Rating
CY1, CY2, CY5, CY6	4700PF/250VAC
CX1	2.2 $\mu$ /100V
CY7, CY8, CY9, CY10	1000PF/250VAC
CY3, CY4	0.47 $\mu$
Cin1	47 $\mu$ /100V
CX2	1 $\mu$ /100V
Cout1	470 $\mu$ /10V (low ESR capacitor)
Cout2	1 $\mu$ /10V
L1	1.8mH

## Safety Consideration

For safety-agency approval of the system in which the converter is used, the converter must

be installed in compliance with the spacing and separation requirements of the end-use safety agency standard, i.e., UL1950, CSA C22.2 No. 950-95, and EN60950. The input-to-output isolation is a basic insulation. The converter should be installed in end-use equipment, in compliance with the requirements of the ultimate application, and is intended to be supplied by an isolated secondary circuit. When the supply to the converter meets all the requirements for SELV (<60Vdc), the output is considered to remain within SELV limits (level 3). If connected to a 60Vdc power system, double or reinforced insulation must be provided in the converter that isolates the input from any hazardous voltages, including the AC mains. One input pin and one output pin are to be grounded or both the input and output pins are to be kept floating. Single fault testing in the converter must be performed in combination with the converter to demonstrate that the output meets the requirement for SELV. The input pins of the converter are not operator accessible.

Note: Do not ground either of the input pins of the converter, without grounding one of the output pins. This may allow a non-SELV voltage to appear between the output pin and ground.

Note:

To comply with the published safety standards, the following must be observed when using this built-in converter.

1. The converter is intended for use as a component part of other equipment. When installing the converter and marking input and output connections, the relevant safety standards e.g. UL 60950-1; IEC 60950-1/VDE 0805;EN60950-1; CAN/CSA-22.2NO.60950-1-03 must be complied with, especially the requirements for creepage distances, clearances and distance through insulation between primary and earth or primary and secondary.
2. The output power taken from the built-in converter must not exceed the rating given on the converter.
3. The converter is not intended to be repaired by service personnel in case of failure or component defect.
4. The maximum ambient temperature around the converter must not exceed 55°C.
5. An external forced air cooling (CFM: 80.2, Speed: 1m/s, distance from the converter: 20cm) shall be used for converter operates with full load and ambient up to 55°C.
6. The converter has no in-line fuse. For safety purpose, a fast acting UL listed fuse or UL recognized fuse rated 5A/250V needs to be connected to the input side as external protection.

## Thermal Consideration

Thermal management is an important part of the system design. The converter has ultra high efficiency at full load, and the converter exhibit good performance during pro-longed exposure to high temperatures. However, to ensure proper and reliable operation, sufficient cooling of the converter and power derating is needed over the entire temperature range of the converter. Considerations includes ambient temperature, airflow and converter power derating.

Measuring thermal reference point of the converter as the method shown in Fig.82 can verify the proper cooling.

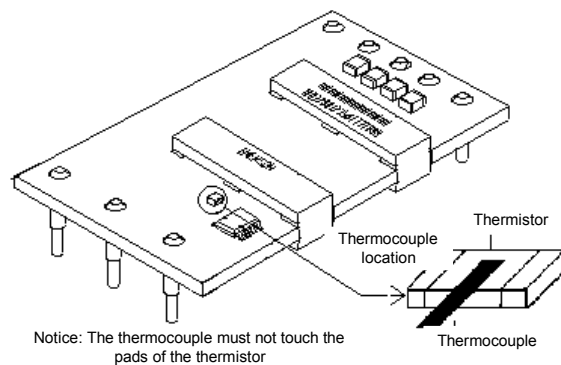

Fig.82 Temperature measurement location

## Converter Derating

With 48V input, 55°C ambient temperature, and 200LFM airflow, the converter is rated for full power. For operation above ambient temperature of 55°C, the output power must be derated as shown in Fig.83 to Fig.89,. Meantime, airflow at least 200LFM over the converter must be provided to make the converter working properly.

It is recommended that the temperature of the thermal reference point be measured using a thermocouple. Temperature on the PCB at the thermocouple location shown in Fig. 82 should

not exceed 125°C in order to operate inside the derating curves as shown Fig. 83 to Fig.89. The use of output power derating curve is shown in the following example.

Example

What is the minimum airflow necessary for AVO50-48S3V3 operating at VI = 48V, an output current of 20A, and a maximum ambient temperature of 55°C?

Solution

Given: VI = 48V, Io = 20A, Ta = 55°C

Determine airflow (v) (use Fig.83 to 89): v = 1m/sec. (200ft./min.)

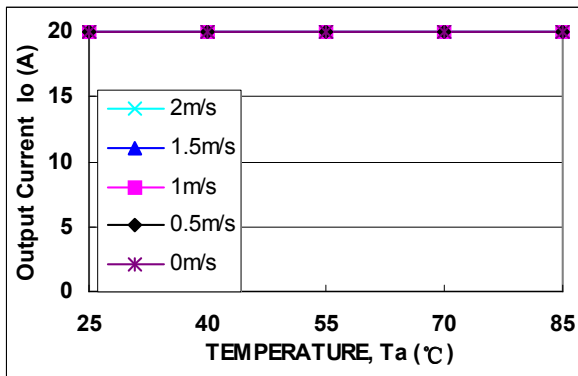

Fig.83 AVO50-48S1V2 output power derating  
Airflow direction from -VIN to +VIN; VIN = 48V

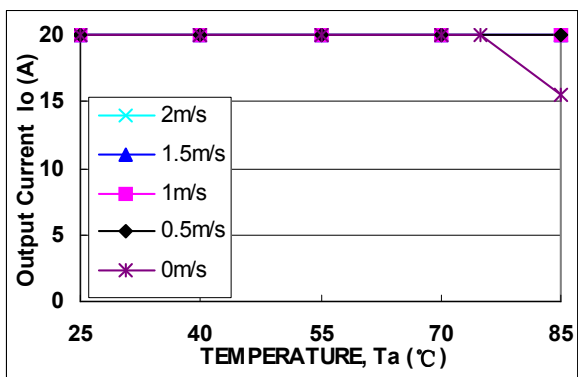

Fig.84 AVO50-48S1V5 output power derating  
Airflow direction from -VIN to +VIN; VIN = 48V

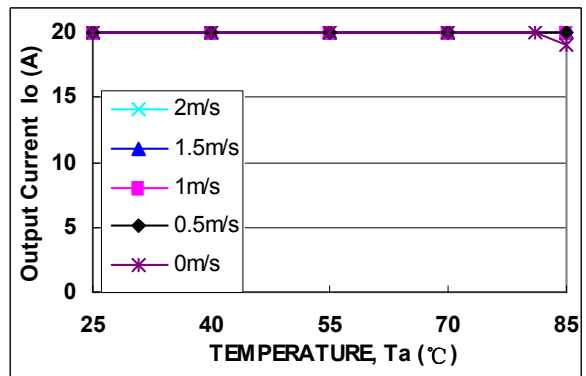

Fig.85 AVO50-48S1V8 output power derating  
Airflow direction from -VIN to +VIN; VIN = 48V

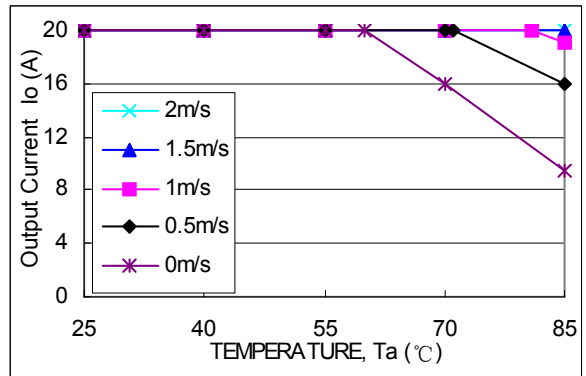

Fig.86 AVO50-48S2V5 output power derating  
Airflow direction from -VIN to +VIN; VIN = 48V

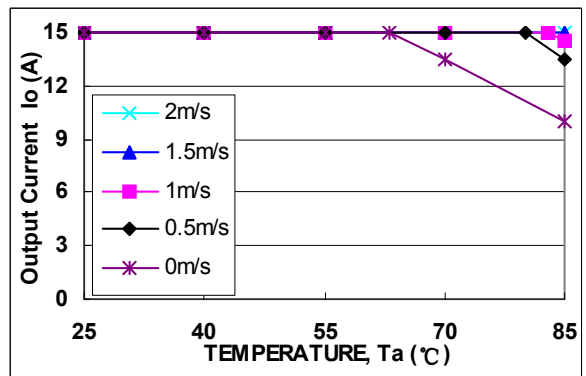

Fig.87 AVO50-48S3V3 output power derating  
Airflow direction from -VIN to +VIN; VIN = 48V

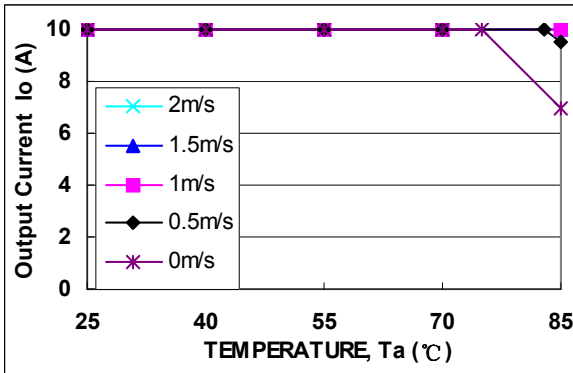

Fig.88 AVO50-48S05 output power derating  
Airflow direction from -VIN to +VIN; VIN = 48V

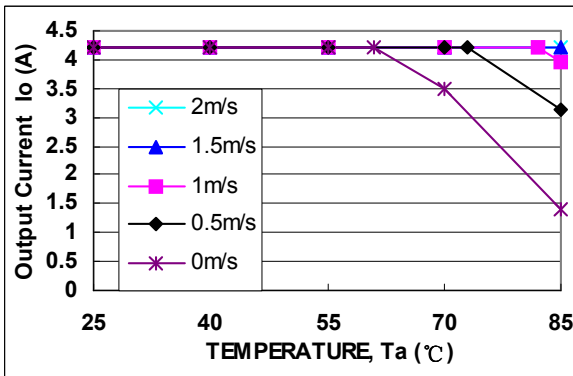

Fig.89 AVO50-48S12 output power derating  
Airflow direction from -VIN to +VIN; VIN = 48V

## MTBF

The MTBF, calculated in accordance with Bellcore TR-NWT-000332, is 2,500,000 hours. Obtaining this MTBF in practice is entirely possible. If the board temperature is expected to exceed +25°C, then we also advise an oriented for the best possible cooling in the air stream.

Emerson can supply replacements for converters from other manufacturers, or offer custom solutions. Please contact the factory for details.

## Mechanical Considerations

### Installation

Although the converters can be mounted in any orientation, free air flowing must be taken. Normally power components are always put at the end of the airflow path or have the separate airflow paths. This can keep other system equipment cooler and increase component life spans.

### Soldering

The converter is compatible with standard wave soldering techniques. When wave soldering, the converter pins should be preheated for 20~30 seconds at 110°C, and wave soldered at 260°C for less than 10 seconds.

When hand soldering, the iron temperature should be maintained at 425°C and applied to the converter pins for less than 5 seconds. Longer exposure can cause internal damage to the converter. Cleaning can be performed with cleaning solvent IPA or with water.



## Mechanical Chart (Top & pin side view)

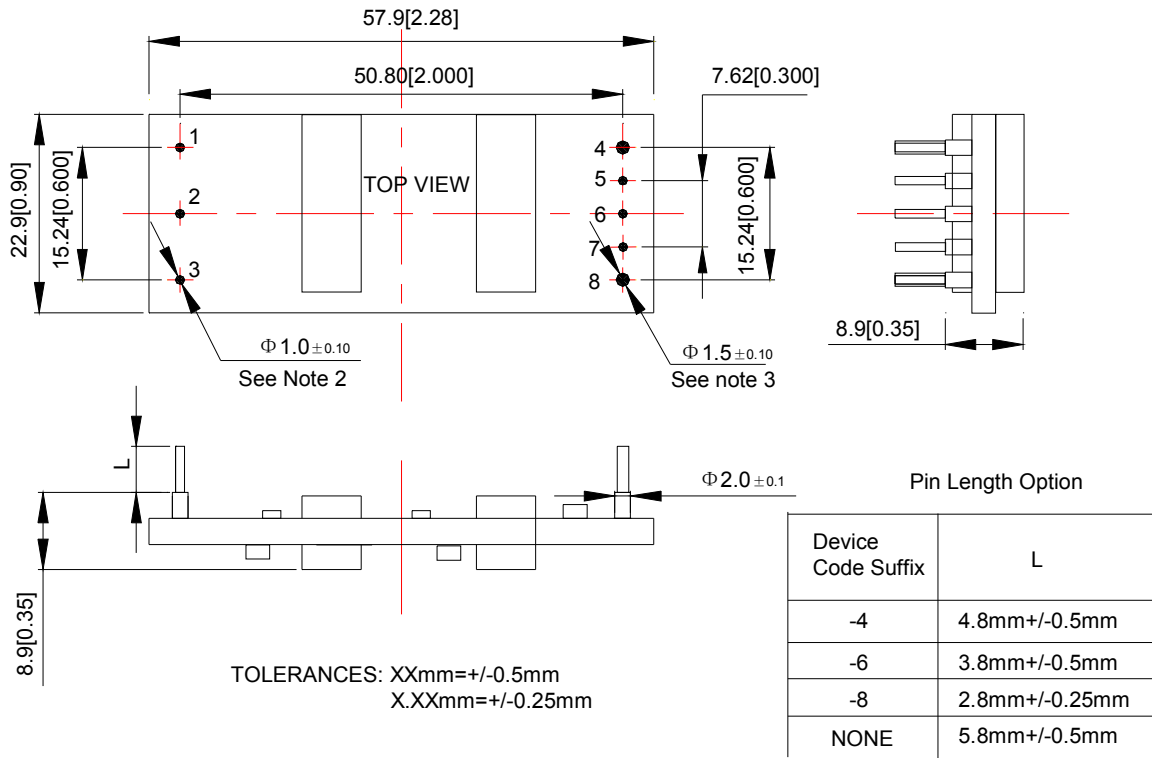

**Notes:**

1. Un-dimensioned components are for visual reference only.
2. Pins 1~3, 5~7 are 1.0mm diameter with 2.0mm diameter standoff shoulders.
3. Pin 4 and pin 8 are 1.5mm diameter with no standoff shoulders.

Pin No.	Function	Pin No.	Function
1	+Vin	4	+Vo
2	CNT	5	+Sense
3	-Vin	6	Trim
		7	-Sense
		8	-Vo

## Ordering Information

Model Number	Input Voltage (V)	Output Voltage (V)	Output Current (A)	Ripple and Noise (mV pp)	Efficiency (%) Typ.
				Typ.	
AVO50-48S1V2	36~75	1.2	20	0	86
AVO50-48S1V5	36~75	1.5	20	0	88
AVO50-48S1V8	36~75	1.8	20	0	88.5
AVO50-48S2V5	36~75	2.5	20	60	89.5
AVO50-48S3V3	36~75	3.3	15	0	91
AVO50-48S05	36~75	5	10	0	91
AVO50-48S12	36~75	12	4.2	90	91

### 有毒有害物质或元素标识表

部件名称	有毒有害物质或元素					
	铅	汞	镉	六价铬	多溴联苯	多溴联苯醚
	Pb	Hg	Cd	Cr6+	PBB	PBDE
制成板	○	○	○	○	○	○
<p>○：表示该有毒有害物质在该部件所有均质材料中的含量在 SJ/T-11363-2006 规定的限量要求以下。</p> <p>×：表示该有毒有害物质至少在该部件的某一均质材料中的含量超出 SJ/T-11363-2006 规定的限量要求</p> <p>艾默生网络能源有限公司一直致力于设计和制造环保的产品，我们会通过持续的研究来减少和消除产品中的有毒有害物质。以下部件或应用中含有有毒有害物质是限于目前的技术水平无法实现可靠的替代或者没有成熟的解决方案：</p> <ol style="list-style-type: none"> <li>1. 焊料（含器件的高温焊料）中含有铅。</li> <li>2. 电子器件的玻璃中含有铅。</li> <li>3. 插针的铜合金中含有铅</li> </ol> <p>适用范围：AVO50 系列</p>						

Компания «Океан Электроники» предлагает заключение долгосрочных отношений при поставках импортных электронных компонентов на взаимовыгодных условиях!

Наши преимущества:

- Поставка оригинальных импортных электронных компонентов напрямую с производств Америки, Европы и Азии, а так же с крупнейших складов мира;
- Широкая линейка поставок активных и пассивных импортных электронных компонентов (более 30 млн. наименований);
- Поставка сложных, дефицитных, либо снятых с производства позиций;
- Оперативные сроки поставки под заказ (от 5 рабочих дней);
- Экспресс доставка в любую точку России;
- Помощь Конструкторского Отдела и консультации квалифицированных инженеров;
- Техническая поддержка проекта, помощь в подборе аналогов, поставка прототипов;
- Поставка электронных компонентов под контролем ВП;
- Система менеджмента качества сертифицирована по Международному стандарту ISO 9001;
- При необходимости вся продукция военного и аэрокосмического назначения проходит испытания и сертификацию в лаборатории (по согласованию с заказчиком);
- Поставка специализированных компонентов военного и аэрокосмического уровня качества (Xilinx, Altera, Analog Devices, Intersil, Interpoint, Microsemi, Actel, Aeroflex, Peregrine, VPT, Syfer, Eurofarad, Texas Instruments, MS Kennedy, Miteq, Cobham, E2V, MA-COM, Hittite, Mini-Circuits, General Dynamics и др.);

Компания «Океан Электроники» является официальным дистрибьютором и эксклюзивным представителем в России одного из крупнейших производителей разъемов военного и аэрокосмического назначения «JONHON», а так же официальным дистрибьютором и эксклюзивным представителем в России производителя высокотехнологичных и надежных решений для передачи СВЧ сигналов «FORSTAR».



## JONHON

«JONHON» (основан в 1970 г.)

Разъемы специального, военного и аэрокосмического назначения:

(Применяются в военной, авиационной, аэрокосмической, морской, железнодорожной, горно- и нефтедобывающей отраслях промышленности)

«FORSTAR» (основан в 1998 г.)

ВЧ соединители, коаксиальные кабели, кабельные сборки и микроволновые компоненты:

(Применяются в телекоммуникациях гражданского и специального назначения, в средствах связи, РЛС, а так же военной, авиационной и аэрокосмической отраслях промышленности).



Телефон: 8 (812) 309-75-97 (многоканальный)

Факс: 8 (812) 320-03-32

Электронная почта: [ocean@oceanchips.ru](mailto:ocean@oceanchips.ru)

Web: <http://oceanchips.ru/>

Адрес: 198099, г. Санкт-Петербург, ул. Калинина, д. 2, корп. 4, лит. А