

NCS2003/A, NCV2003, NCS20032, NCV20032, NCS20034, NCV20034



ON Semiconductor®

www.onsemi.com

Operational Amplifiers, High Slew Rate, Low Voltage, Rail-to-Rail Output

The NCS2003 family of op amps features high slew rate, low voltage operation with rail-to-rail output drive capability. The 1.8 V operation allows high performance operation in low voltage, low power applications. The fast slew rate and wide unity-gain bandwidth (5 MHz at 1.8 V) make these op amps suited for high speed applications. The low input offset voltage (4 mV max) allows the op amp to be used for current shunt monitoring. Additional features include no output phase reversal with overdriven inputs and ultra low input bias current of 1 pA.

The NCS2003 family is the ideal solution for a wide range of applications and products. The single channel NCS2003, dual channel NCS20032, and quad channel NCS20034 are available in a variety of compact and space-saving packages. The NCV prefix denotes that the device is AEC-Q100 Qualified and PPAP Capable.

Features

- Unity Gain Bandwidth: 7 MHz at $V_S = 5\text{ V}$
- Fast Slew Rate: 8 V/ μs rising, 12.5 V/ μs falling at $V_S = 5\text{ V}$
- Rail-to-Rail Output
- No Output Phase Reversal for Over-Driven Input Signals
- Low Offset Voltage: 0.5 mV typical
- Low Input Bias Current: 1 pA typical
- NCV Prefix for Automotive and Other Applications Requiring Unique Site and Control Change Requirements; AEC-Q100 Qualified and PPAP Capable
- These Devices are Pb-Free, Halogen Free/BFR Free and are RoHS Compliant

Applications

- Current Shunt Monitor
- Signal Conditioning
- Active Filter
- Sensor Buffer

End Products

- Motor Control Drives
- Hard Drives
- Medical Devices
- White Goods and Air Conditioners

MARKING DIAGRAMS



SOT23-5
CASE 483
(NCS/NCV2003)

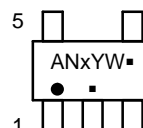

SOT553, 5 LEAD
CASE 463B
(NCS2003)



Micro8™
DM SUFFIX
CASE 846A

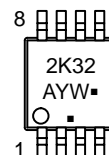

SOIC-8
CASE 751

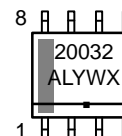

TSSOP-8
T SUFFIX
CASE 948S

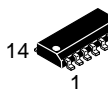
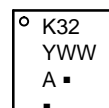

SOIC-14 NB
CASE 751A

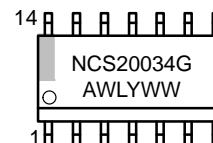

A = Assembly Location
WL, L = Wafer Lot
Y = Year
WW, W = Work Week
G or ■ = Pb-Free Package

(Note: Microdot may be in either location)

ORDERING INFORMATION

See detailed ordering, marking and shipping information on page 2 of this data sheet.

NCS2003/A, NCV2003, NCS20032, NCV20032, NCS20034, NCV20034

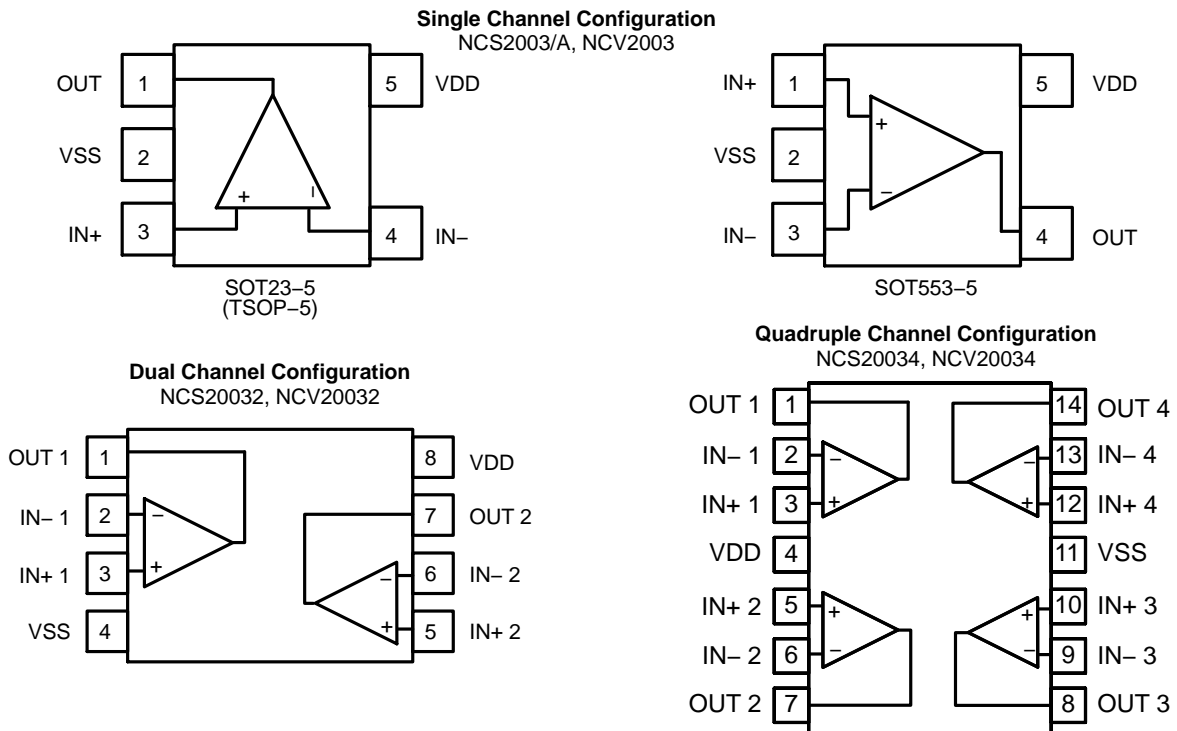

Figure 1. Pin Connections

ORDERING INFORMATION

Device	Configuration	Automotive	Marking	Package	Shipping†
NCS2003SN2T1G	Single	No	AN3	SOT23-5 (Pb-Free)	3000 / Tape and Reel
NCS2003ASN2T1G		No	AN4	SOT23-5 (Pb-Free)	3000 / Tape and Reel
NCS2003XV53T2G		No	A3	SOT553-5 (Pb-Free)	4000 / Tape and Reel
NCV2003SN2T1G*		Yes	AN3	SOT23-5 (Pb-Free)	3000 / Tape and Reel
NCS20032DMR2G (In Development)**	Dual	No	2K32	Micro8 (Pb-Free)	4000 / Tape and Reel
NCS20032DR2G			20032	SOIC-8 (Pb-Free)	2500 / Tape and Reel
NCS20032DTBR2G (In Development)**			K32	TSSOP-8 (Pb-Free)	3000 / Tape and Reel
NCV20032DMR2G* (In Development)**		Yes	2K32	Micro8 (Pb-Free)	4000 / Tape and Reel
NCV20032DR2G*			20032	SOIC-8 (Pb-Free)	2500 / Tape and Reel
NCV20032DTBR2G*			K32	TSSOP-8 (Pb-Free)	3000 / Tape and Reel
NCS20034DR2G	Quad	No	NCS20034G	SOIC-14 (Pb-Free)	2500 / Tape and Reel
NCV20034DR2G*		Yes	NCS20034G	SOIC-14 (Pb-Free)	2500 / Tape and Reel

†For information on tape and reel specifications, including part orientation and tape sizes, please refer to our Tape and Reel Packaging Specifications Brochure, BRD8011/D

*NCV Prefix for Automotive and Other Applications Requiring Unique Site and Control Change Requirements; AEC-Q100 Qualified and PPAP Capable.

**Contact local sales office for more information.

NCS2003/A, NCV2003, NCS20032, NCV20032, NCS20034, NCV20034

ABSOLUTE MAXIMUM RATINGS

Over operating free-air temperature, unless otherwise stated

Parameter	Symbol	Limit	Unit
Supply Voltage ($V_{DD} - V_{SS}$)	V_S	7.0	V

INPUT AND OUTPUT PINS

Input Voltage (Note 1)	V_{IN}	$V_{SS} - 0.3$ to 7.0	V
Input Current	I_{IN}	10	mA
Output Short Current (Note 2)	I_O	100	mA

TEMPERATURE

Storage Temperature	T_{STG}	-65 to 150	°C
Junction Temperature	T_J	150	°C

ESD RATINGS (Note 3)

Human Body Model	NCx2003, A NCx20032 NCx20034	HBM	3000 2000 3000	V
Machine Model	NCx2003, A NCx20032 NCx20034	MM	200 100 150	V
Charged Device Model	NCx2003, A NCx2003x	CDM	1000 2000	V

OTHER PARAMETERS

Moisture Sensitivity Level (Note 5)	MSL	Level 1	
Latch-up Current (Note 4)	I_{LU}	100	mA

Stresses exceeding those listed in the Maximum Ratings table may damage the device. If any of these limits are exceeded, device functionality should not be assumed, damage may occur and reliability may be affected.

- Neither input should exceed the range of $V_{SS} - 300$ mV to 7.0 V. This device contains internal protection diodes between the input pins and V_{DD} . When V_{IN} exceeds V_{DD} , the input current should be limited to the specified value.
- Indefinite duration; however, maximum package power dissipation limits must be observed to ensure that the maximum junction temperature is not exceeded.
- This device series incorporates ESD protection and is tested by the following methods:
ESD Human Body Model tested per AEC-Q100-002 and JESD22-A114
ESD Machine Model tested per AEC-Q100-003 and JESD22-A115
ESD Charged Device Model tested per AEC-Q100-011 and ANSI/ESD S5.3.1-2009
- Latch-up current tested per JEDEC Standard JESD78.
- Moisture Sensitivity Level tested per IPC/JEDEC standard J-STD-020A.

THERMAL INFORMATION

Thermal Metric	Symbol	Package	Single Layer Board (Note 6)	Multi Layer Board (Note 7)	Unit
Junction to Ambient Thermal Resistance	θ_{JA}	SOT23-5/TSOP-5	408	355	°C/W
		SOT553-5	428	406	
		Micro8/MSOP8	235	163	
		SOIC-8	240	179	
		TSSOP-8	300	238	
		SOIC-14	167	123	

6. Values based on a 1S standard PCB according to JEDEC51-3 with 1.0 oz copper and a 300 mm² copper area

7. Values based on a 1S2P standard PCB according to JEDEC51-7 with 1.0 oz copper and a 100 mm² copper area

RECOMMENDED OPERATING CONDITIONS

Parameter	Symbol	Min	Max	Unit
Operating Supply Voltage ($V_{DD} - V_{SS}$)	V_S	1.7	5.5	V
Specified Operating Range	NCS2003, A NCV2003, NCx20032, NCx20034 T_A	-40 -40	+85 +125	°C
Input Common Mode Range	V_{CM}	V_{SS}	$V_{DD}-0.6$	V

Functional operation above the stresses listed in the Recommended Operating Ranges is not implied. Extended exposure to stresses beyond the Recommended Operating Ranges limits may affect device reliability.

NCS2003/A, NCV2003, NCS20032, NCV20032, NCS20034, NCV20034

ELECTRICAL CHARACTERISTICS: $V_S = +1.8\text{ V}$

At $T_A = +25^\circ\text{C}$, $R_L = 10\text{ k}\Omega$ connected to midsupply, $V_{CM} = V_{OUT} = \text{midsupply}$, unless otherwise noted. **Boldface** limits apply over the specified temperature range. Guaranteed by design and/or characterization.

Parameter	Symbol	Conditions	Min	Typ	Max	Unit
INPUT CHARACTERISTICS						
Input Offset Voltage	V_{OS}	NCS2003A		0.5	3.0	mV
		NCx2003, NCx20032, NCx20034		0.5	4.0	mV
Offset Voltage Drift	$\Delta V_{OS}/\Delta T$			2.0		$\mu\text{V}/^\circ\text{C}$
		NCS2003A (Note 8)			6.0	$\mu\text{V}/^\circ\text{C}$
Input Bias Current	I_{IB}			1		pA
Input Offset Current	I_{OS}			1		pA
Channel Separation	XTLK	DC, NCx20032, NCx20034		100		dB
Input Resistance	R_{IN}			1		$\text{T}\Omega$
Input Capacitance	C_{IN}			1.2		pF
Common Mode Rejection Ratio	CMRR	$V_{IN} = V_{SS}$ to $V_{DD} - 0.6\text{ V}$	70	80		dB
		$V_{IN} = V_{SS} + 0.2\text{ V}$ to $V_{DD} - 0.6\text{ V}$	65			

OUTPUT CHARACTERISTICS

Open Loop Voltage Gain	A_{VOL}	$R_L = 10\text{ k}\Omega$		80	92	dB	
				75			
		$R_L = 2\text{ k}\Omega$			92		
				70			
Output Current Capability (Note 8)	I_{SC}	Sourcing		5	8	mA	
		Sinking		10	14		
Output Voltage High	V_{OH}	$R_L = 10\text{ k}\Omega$		1.75	1.798	V	
		$R_L = 2\text{ k}\Omega$		1.7	1.78		
Output Voltage Low	VOL	$R_L = 10\text{ k}\Omega$	NCx2003, A		7	50	mV
			NCx2003x		7	100	
		$R_L = 2\text{ k}\Omega$				20	

NOISE PERFORMANCE

Voltage Noise Density	e_N	$f = 1\text{ kHz}$		20		$\text{nV}/\sqrt{\text{Hz}}$
Current Noise Density	i_N	$f = 1\text{ kHz}$		0.1		$\text{pA}/\sqrt{\text{Hz}}$

DYNAMIC PERFORMANCE

Gain Bandwidth Product	GBWP			5		MHz
Slew Rate at Unity Gain	SR	Rising Edge, $R_L = 2\text{ k}\Omega$, $A_V = +1$		6		$\text{V}/\mu\text{s}$
		Falling Edge, $R_L = 2\text{ k}\Omega$, $A_V = +1$		9		
Phase Margin	ψ_m	$R_L = 10\text{ k}\Omega$, $C_L = 5\text{ pF}$		53		$^\circ$
Gain Margin	A_m	$R_L = 10\text{ k}\Omega$, $C_L = 5\text{ pF}$	NCx2003, A	12		dB
			NCx2003x	8		
Settling Time	t_s	$V_O = 1\text{ V}_{pp}$, Gain = 1, $C_L = 20\text{ pF}$	Settling time to 0.1%	1.8		μs

Product parametric performance is indicated in the Electrical Characteristics for the listed test conditions, unless otherwise noted. Product performance may not be indicated by the Electrical Characteristics if operated under different conditions.

8. Guaranteed by design and/or characterization.

NCS2003/A, NCV2003, NCS20032, NCV20032, NCS20034, NCV20034

ELECTRICAL CHARACTERISTICS: $V_S = +1.8\text{ V}$

At $T_A = +25^\circ\text{C}$, $R_L = 10\text{ k}\Omega$ connected to midsupply, $V_{CM} = V_{OUT} = \text{midsupply}$, unless otherwise noted. **Boldface** limits apply over the specified temperature range. Guaranteed by design and/or characterization.

Parameter	Symbol	Conditions	Min	Typ	Max	Unit
DYNAMIC PERFORMANCE						
Total Harmonics Distortion + Noise	THD+N	$V_O = 1\text{ V}_{pp}$, $R_L = 2\text{ k}\Omega$, $A_V = +1$, $f = 1\text{ kHz}$		0.005		%
		$V_O = 1\text{ V}_{pp}$, $R_L = 2\text{ k}\Omega$, $A_V = +1$, $f = 10\text{ kHz}$		0.025		

POWER SUPPLY

Power Supply Rejection Ratio	PSRR	NCx2003		72	80		dB
				65			
		NCx20032, NCx20034		80	100		
Quiescent Current	I_{DD}	No load, per channel	NCx2003, A		230	560	μA
						1000	
		NCx20032, NCx20034		275	375		
					575		

Product parametric performance is indicated in the Electrical Characteristics for the listed test conditions, unless otherwise noted. Product performance may not be indicated by the Electrical Characteristics if operated under different conditions.

8. Guaranteed by design and/or characterization.

ELECTRICAL CHARACTERISTICS: $V_S = +5.0\text{ V}$

At $T_A = +25^\circ\text{C}$, $R_L = 10\text{ k}\Omega$ connected to midsupply, $V_{CM} = V_{OUT} = \text{midsupply}$, unless otherwise noted. **Boldface** limits apply over the specified temperature range. Guaranteed by design and/or characterization.

Parameter	Symbol	Conditions	Min	Typ	Max	Unit
INPUT CHARACTERISTICS						
Input Offset Voltage	V_{OS}	NCS2003A		0.5	3.0	mV
		NCx2003		0.5	4.0	mV
		NCx20032, NCx20034			5.0	mV
Offset Voltage Drift	$\Delta V_{OS}/\Delta T$			2.0		$\mu\text{V}/^\circ\text{C}$
		NCS2003A (Note 9)			6.0	$\mu\text{V}/^\circ\text{C}$
Input Bias Current	I_{IB}			1		pA
Input Offset Current	I_{OS}			1		pA
Channel Separation	XTLK	DC, NCx20032, NCx20034		100		dB
Input Resistance	R_{IN}			1		$\text{T}\Omega$
Input Capacitance	C_{IN}			1.2		pF

Product parametric performance is indicated in the Electrical Characteristics for the listed test conditions, unless otherwise noted. Product performance may not be indicated by the Electrical Characteristics if operated under different conditions.

9. Guaranteed by design and/or characterization.

NCS2003/A, NCV2003, NCS20032, NCV20032, NCS20034, NCV20034

ELECTRICAL CHARACTERISTICS: $V_S = +5.0\text{ V}$

At $T_A = +25^\circ\text{C}$, $R_L = 10\text{ k}\Omega$ connected to midsupply, $V_{CM} = V_{OUT} = \text{midsupply}$, unless otherwise noted. **Boldface** limits apply over the specified temperature range. Guaranteed by design and/or characterization.

Parameter	Symbol	Conditions	Min	Typ	Max	Unit
-----------	--------	------------	-----	-----	-----	------

INPUT CHARACTERISTICS

Common Mode Rejection Ratio	CMRR	NCx2003, A	$V_{IN} = V_{SS}$ to $V_{DD} - 0.6\text{ V}$	65	90		dB
			$V_{IN} = V_{SS} + 0.2\text{ V}$ to $V_{DD} - 0.6\text{ V}$	63			
		NCx20032, NCx20034	$V_{IN} = V_{SS}$ to $V_{DD} - 0.6\text{ V}$	70	90		
			$V_{IN} = V_{SS} + 0.2\text{ V}$ to $V_{DD} - 0.6\text{ V}$	65			

OUTPUT CHARACTERISTICS

Open Loop Voltage Gain	A_{VOL}	$R_L = 10\text{ k}\Omega$		86	92		dB
				78			
		$R_L = 2\text{ k}\Omega$		83	92		
				78			
Output Current Capability (Note 9)	I_{SC}	Sourcing		40	76		mA
		Sinking		50	96		
Output Voltage High	V_{OH}	$R_L = 10\text{ k}\Omega$		4.95	4.99		V
		$R_L = 2\text{ k}\Omega$		4.9	4.97		
Output Voltage Low	V_{OL}	$R_L = 10\text{ k}\Omega$	NCx2003, A		8	50	mV
			NCx2003x		8	100	
		$R_L = 2\text{ k}\Omega$			24	100	

NOISE PERFORMANCE

Voltage Noise Density	e_N	$f = 1\text{ kHz}$		20		$\text{nV}/\sqrt{\text{Hz}}$
Current Noise Density	i_N	$f = 1\text{ kHz}$		0.1		$\text{pA}/\sqrt{\text{Hz}}$

DYNAMIC PERFORMANCE

Gain Bandwidth Product	GBWP			7		MHz
Slew Rate at Unity Gain	SR	Rising Edge, $R_L = 2\text{ k}\Omega$, $A_V = +1$		8		$\text{V}/\mu\text{s}$
		Falling Edge, $R_L = 2\text{ k}\Omega$, $A_V = +1$		12.5		
Phase Margin	ψ_m	$R_L = 10\text{ k}\Omega$, $C_L = 5\text{ pF}$	NCx2003, A	64		$^\circ$
			NCx2003x	56		
Gain Margin	A_m	$R_L = 10\text{ k}\Omega$, $C_L = 5\text{ pF}$		9		dB
Settling Time	t_S	$V_O = 1\text{ V}_{pp}$, Gain = 1, $C_L = 20\text{ pF}$	Settling time to 0.1%	0.6		μs
Total Harmonics Distortion + Noise	THD+N	$V_O = 4\text{ V}_{pp}$, $R_L = 2\text{ k}\Omega$, $A_V = +1$, $f = 1\text{ kHz}$		0.002		%
		$V_O = 4\text{ V}_{pp}$, $R_L = 2\text{ k}\Omega$, $A_V = +1$, $f = 10\text{ kHz}$		0.01		

Product parametric performance is indicated in the Electrical Characteristics for the listed test conditions, unless otherwise noted. Product performance may not be indicated by the Electrical Characteristics if operated under different conditions.

9. Guaranteed by design and/or characterization.

NCS2003/A, NCV2003, NCS20032, NCV20032, NCS20034, NCV20034

ELECTRICAL CHARACTERISTICS: $V_S = +5.0\text{ V}$

At $T_A = +25^\circ\text{C}$, $R_L = 10\text{ k}\Omega$ connected to midsupply, $V_{CM} = V_{OUT} = \text{midsupply}$, unless otherwise noted. **Boldface** limits apply over the specified temperature range. Guaranteed by design and/or characterization.

Parameter	Symbol	Conditions	Min	Typ	Max	Unit		
POWER SUPPLY								
Power Supply Rejection Ratio	PSRR	NCx2003, A		72	80		dB	
				65				
		NCx20032, NCx20034		80	100			
Quiescent Current	I_{DD}	No load, per channel	NCx2003, A			300	660	μA
							1000	
			NCx20032, NCx20034			325	450	
						675		

Product parametric performance is indicated in the Electrical Characteristics for the listed test conditions, unless otherwise noted. Product performance may not be indicated by the Electrical Characteristics if operated under different conditions.

9. Guaranteed by design and/or characterization.

TYPICAL CHARACTERISTICS

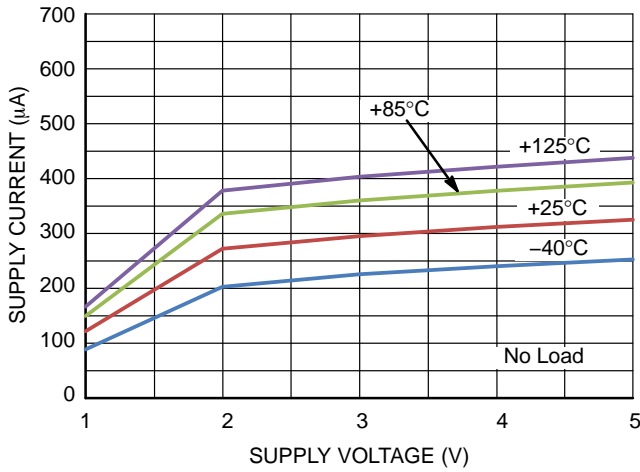

Figure 2. Quiescent Supply Current vs. Supply Voltage

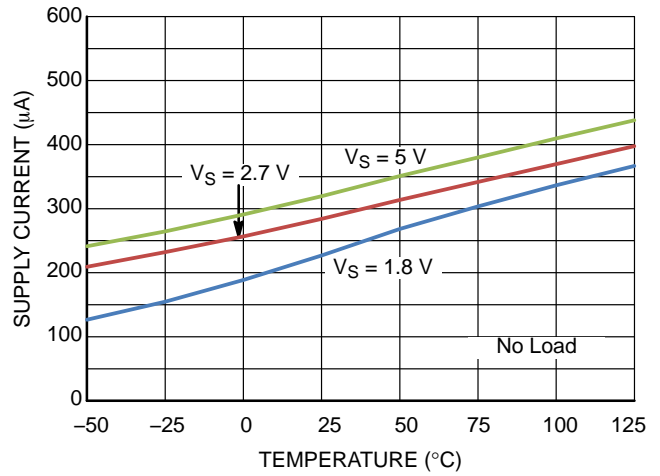

Figure 3. Quiescent Supply Current vs. Temperature

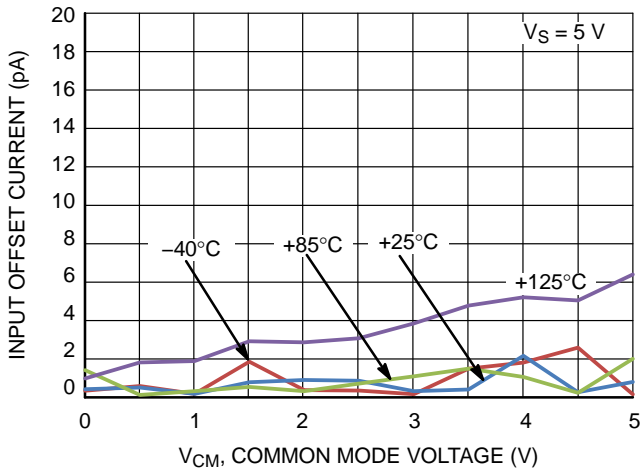

Figure 4. Input Offset Current vs. V_{CM}

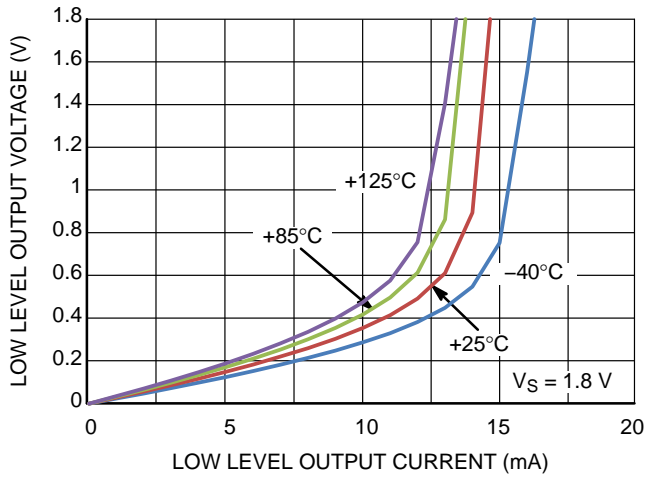

Figure 5. Low Level Output Voltage vs. Output Current @ $V_S = 1.8 V$

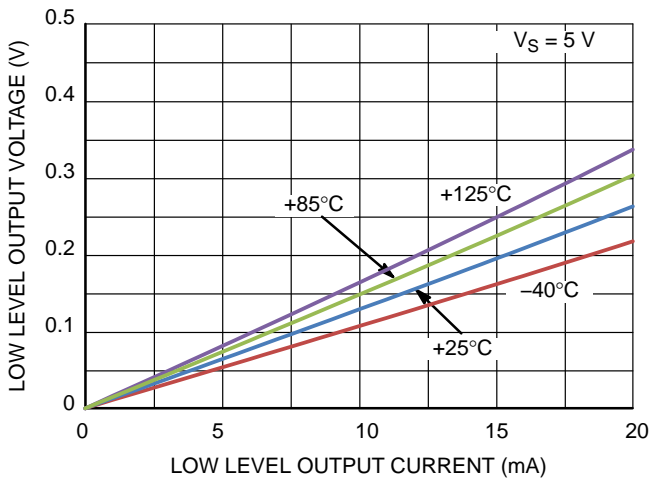

Figure 6. Low Level Output Voltage vs. Output Current @ $V_S = 5 V$

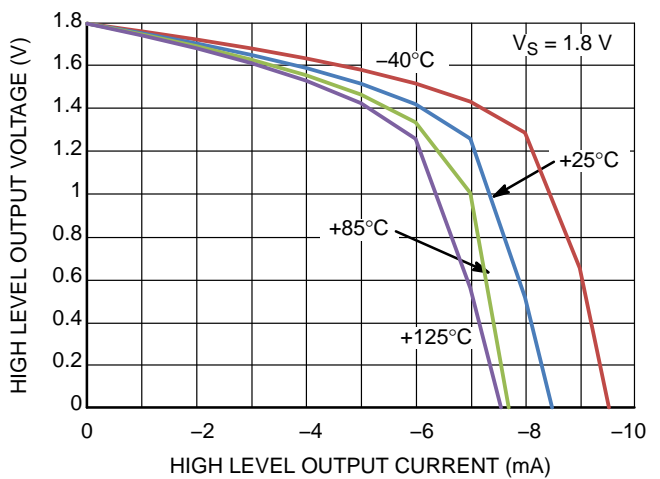

Figure 7. High Level Output Voltage vs. Output Current @ $V_S = 1.8 V$

TYPICAL CHARACTERISTICS

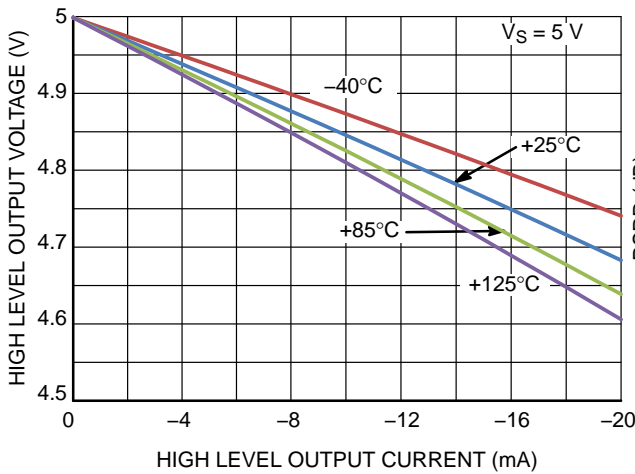

Figure 8. High Level Output Voltage vs. Output Current @ $V_S = 5\text{ V}$

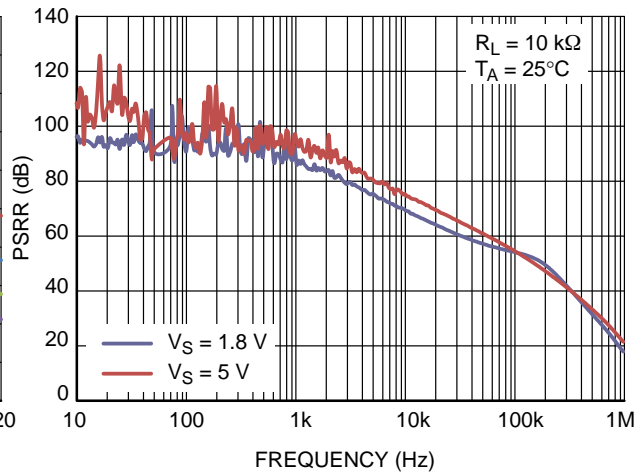

Figure 9. PSRR vs. Frequency

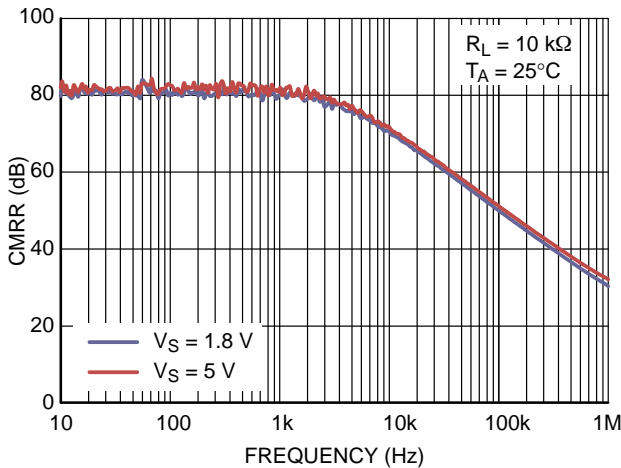

Figure 10. CMRR vs. Frequency

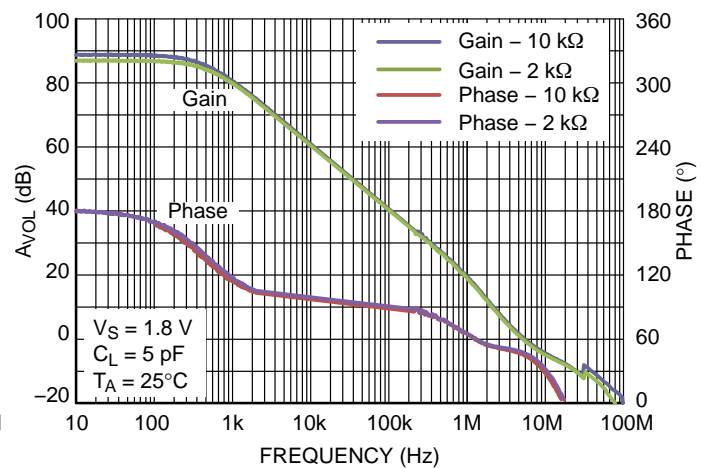

Figure 11. Open Loop Gain and Phase vs. Frequency @ $V_S = 1.8\text{ V}$

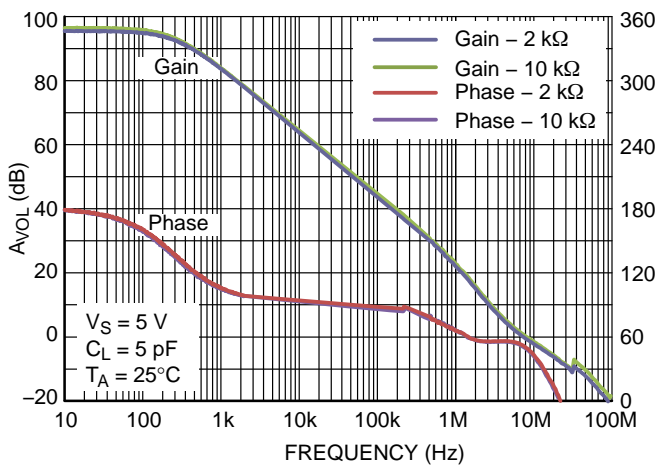

Figure 12. Open Loop Gain and Phase vs. Frequency @ $V_S = 5\text{ V}$

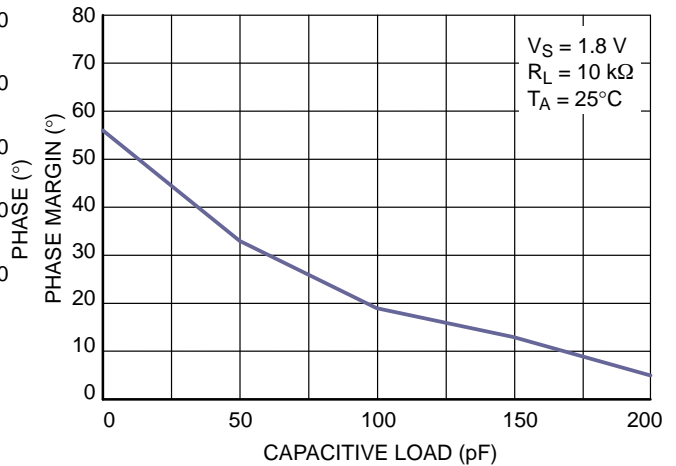

Figure 13. Phase Margin vs. Capacitive Load

TYPICAL CHARACTERISTICS

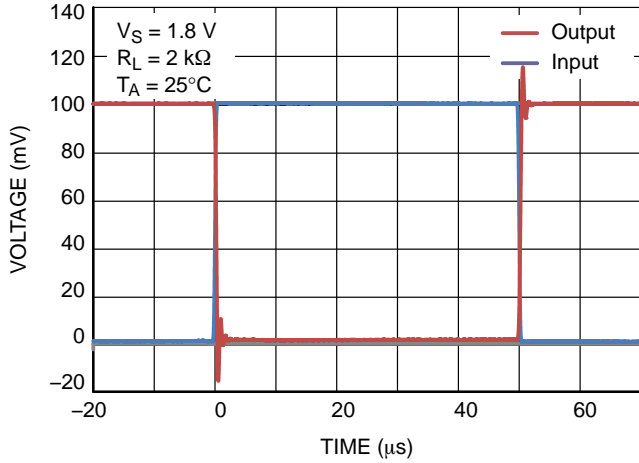

Figure 14. Inverting Small Signal Transient Response

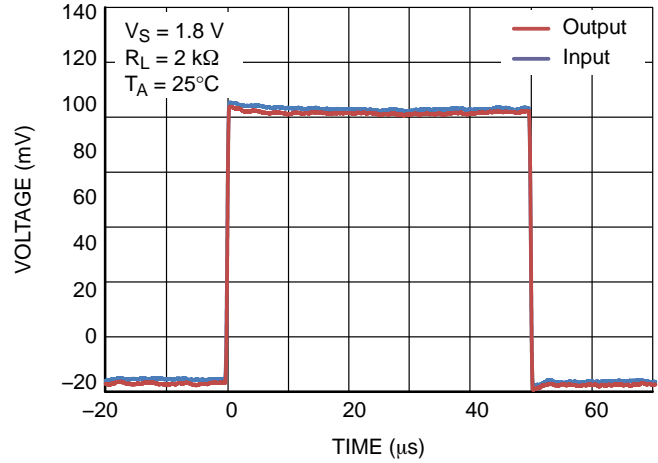

Figure 15. Non-Inverting Small Signal Transient Response

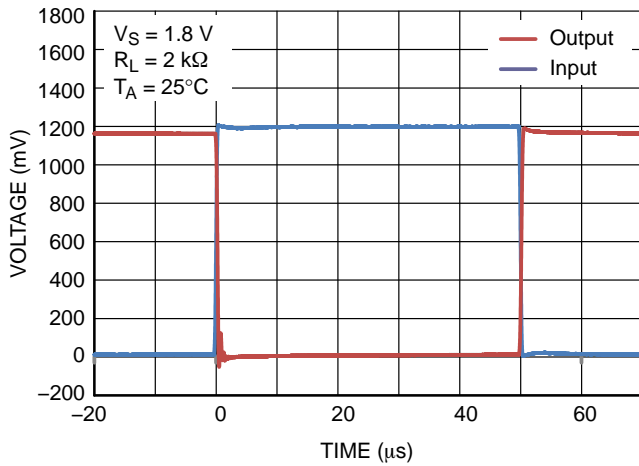

Figure 16. Inverting Large Signal Transient Response

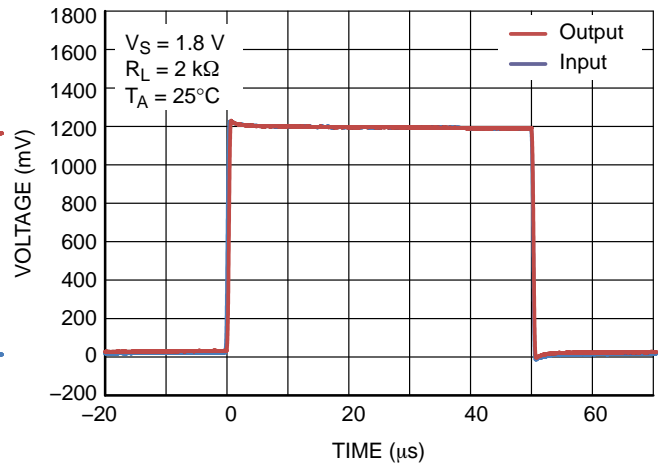

Figure 17. Non-Inverting Large Signal Transient Response

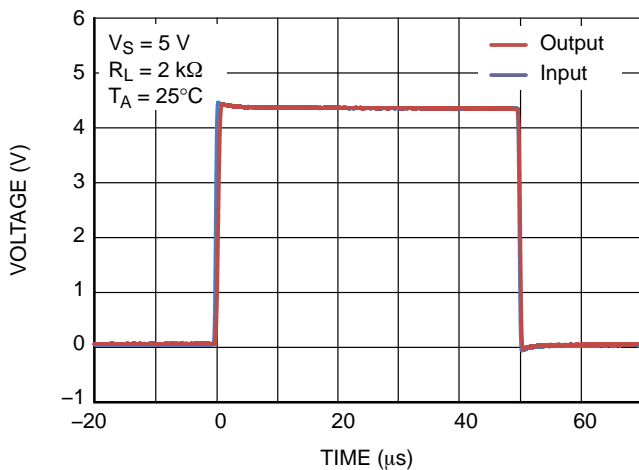

Figure 18. Non-Inverting Large Signal Transient Response

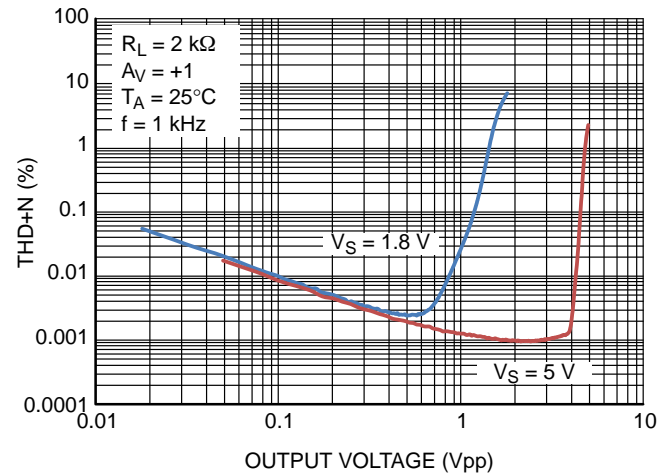

Figure 19. THD+N vs. Output Voltage

TYPICAL CHARACTERISTICS

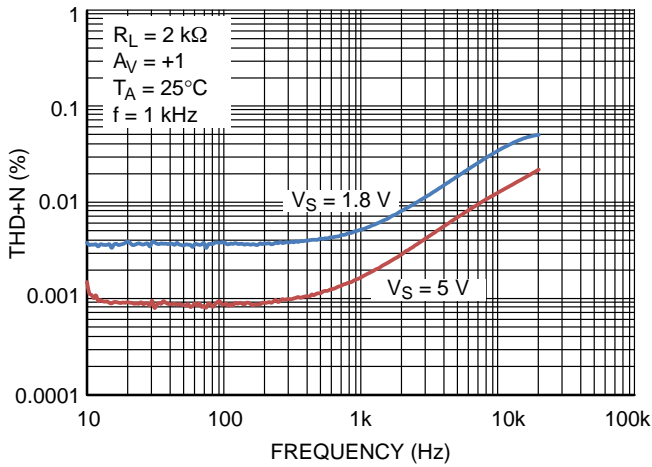

Figure 20. THD+N vs. Frequency

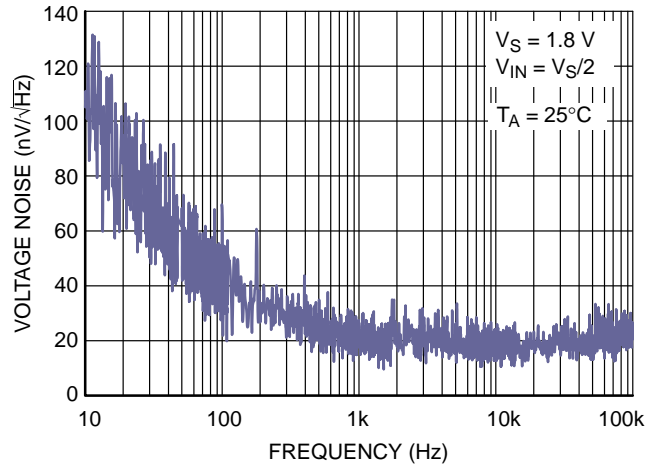

Figure 21. Input Voltage Noise vs. Frequency

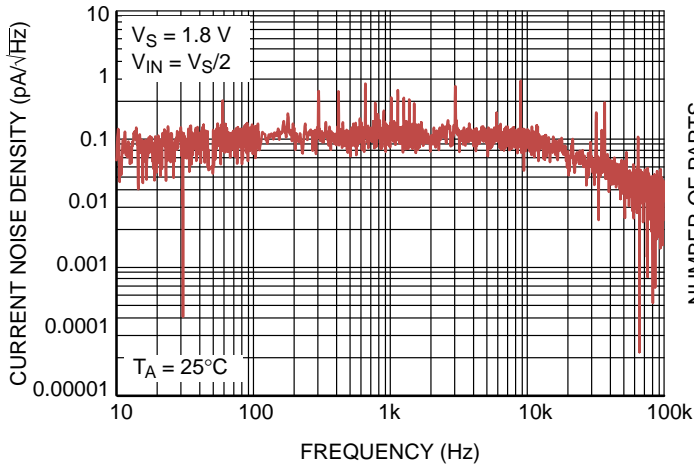

Figure 22. Noise Density vs. Frequency

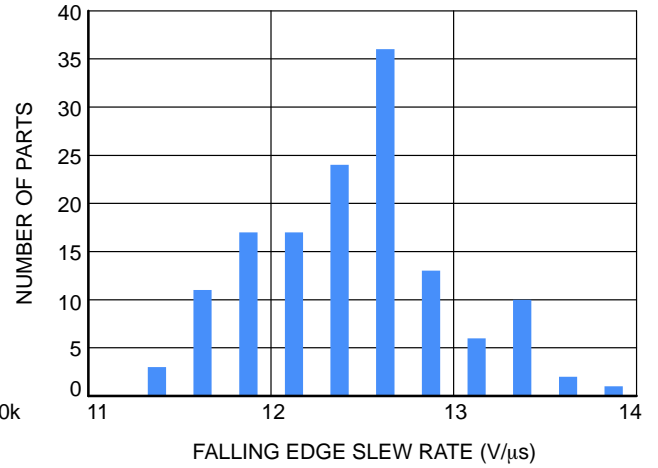

Figure 23. Falling Edge Slew Rate @ Vs = 5 V

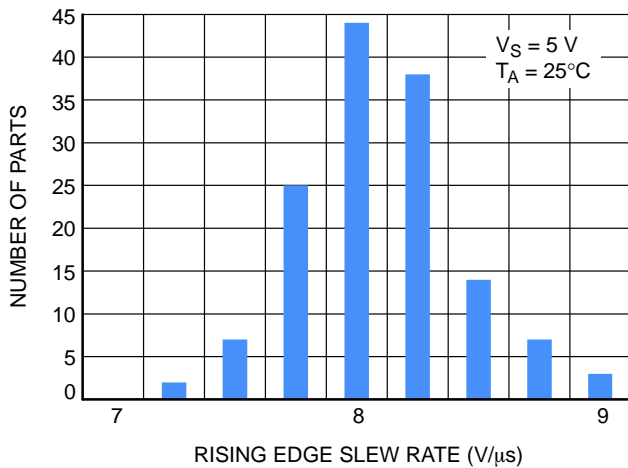

Figure 24. Rising Edge Slew Rate @ Vs = 5 V

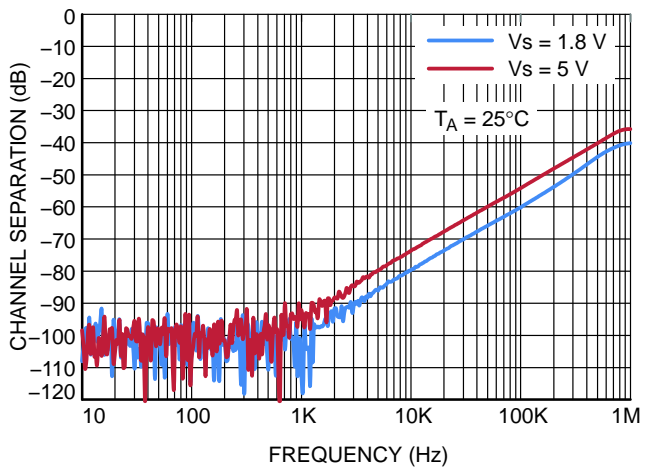
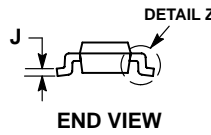
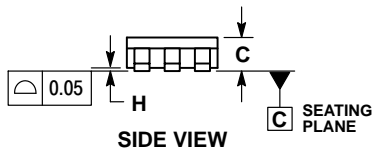
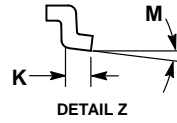
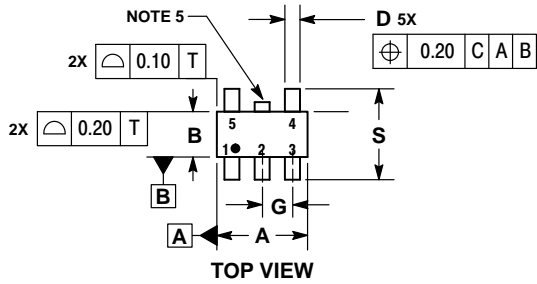

Figure 25. Channel Separation

PACKAGE DIMENSIONS

TSOP-5
CASE 483-02
ISSUE K



NOTES:

1. DIMENSIONING AND TOLERANCING PER ASME Y14.5M, 1994.
2. CONTROLLING DIMENSION: MILLIMETERS.
3. MAXIMUM LEAD THICKNESS INCLUDES LEAD FINISH THICKNESS. MINIMUM LEAD THICKNESS IS THE MINIMUM THICKNESS OF BASE MATERIAL.
4. DIMENSIONS A AND B DO NOT INCLUDE MOLD FLASH, PROTRUSIONS, OR GATE BURRS. MOLD FLASH, PROTRUSIONS, OR GATE BURRS SHALL NOT EXCEED 0.15 PER SIDE. DIMENSION A.
5. OPTIONAL CONSTRUCTION: AN ADDITIONAL TRIMMED LEAD IS ALLOWED IN THIS LOCATION. TRIMMED LEAD NOT TO EXTEND MORE THAN 0.2 FROM BODY.

DIM	MILLIMETERS	
	MIN	MAX
A	3.00	BSC
B	1.50	BSC
C	0.90	1.10
D	0.25	0.50
G	0.95	BSC
H	0.01	0.10
J	0.10	0.26
K	0.20	0.60
M	0°	10°
S	2.50	3.00

SOLDERING FOOTPRINT*

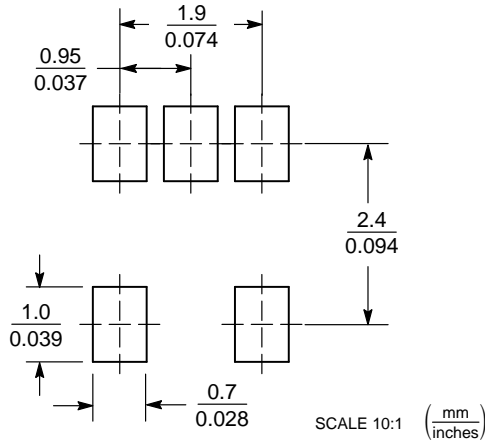

*For additional information on our Pb-Free strategy and soldering details, please download the ON Semiconductor Soldering and Mounting Techniques Reference Manual, SOLDERRM/D.

PACKAGE DIMENSIONS

SOT-553, 5 LEAD
CASE 463B
ISSUE C

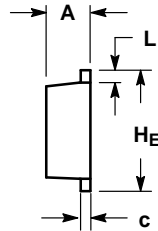
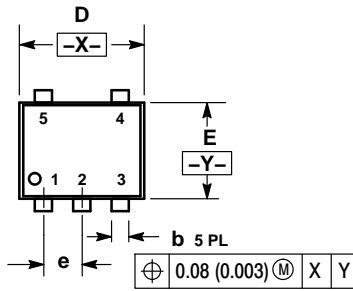

NOTES:

1. DIMENSIONING AND TOLERANCING PER ANSI Y14.5M, 1982.
2. CONTROLLING DIMENSION: MILLIMETERS
3. MAXIMUM LEAD THICKNESS INCLUDES LEAD FINISH THICKNESS. MINIMUM LEAD THICKNESS IS THE MINIMUM THICKNESS OF BASE MATERIAL.

DIM	MILLIMETERS			INCHES		
	MIN	NOM	MAX	MIN	NOM	MAX
A	0.50	0.55	0.60	0.020	0.022	0.024
b	0.17	0.22	0.27	0.007	0.009	0.011
c	0.08	0.13	0.18	0.003	0.005	0.007
D	1.55	1.60	1.65	0.061	0.063	0.065
E	1.15	1.20	1.25	0.045	0.047	0.049
e	0.50 BSC			0.020 BSC		
L	0.10	0.20	0.30	0.004	0.008	0.012
HE	1.55	1.60	1.65	0.061	0.063	0.065

RECOMMENDED
SOLDERING FOOTPRINT*

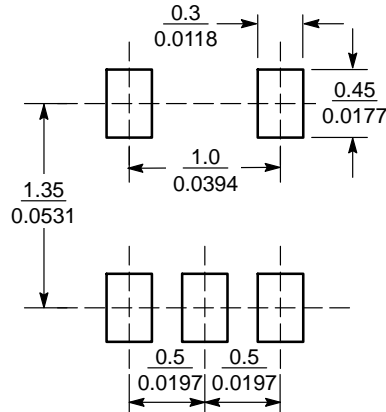

SCALE 20:1 (mm/inches)

*For additional information on our Pb-Free strategy and soldering details, please download the ON Semiconductor Soldering and Mounting Techniques Reference Manual, SOLDERRM/D.

PACKAGE DIMENSIONS

Micro8™
CASE 846A-02
ISSUE J

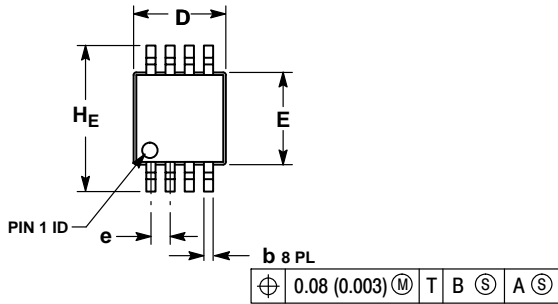

NOTES:

1. DIMENSIONING AND TOLERANCING PER ANSI Y14.5M, 1982.
2. CONTROLLING DIMENSION: MILLIMETER.
3. DIMENSION A DOES NOT INCLUDE MOLD FLASH, PROTRUSIONS OR GATE BURRS. MOLD FLASH, PROTRUSIONS OR GATE BURRS SHALL NOT EXCEED 0.15 (0.006) PER SIDE.
4. DIMENSION B DOES NOT INCLUDE INTERLEAD FLASH OR PROTRUSION. INTERLEAD FLASH OR PROTRUSION SHALL NOT EXCEED 0.25 (0.010) PER SIDE.
5. 846A-01 OBSOLETE, NEW STANDARD 846A-02.

DIM	MILLIMETERS			INCHES		
	MIN	NOM	MAX	MIN	NOM	MAX
A	—	—	1.10	—	—	0.043
A1	0.05	0.08	0.15	0.002	0.003	0.006
b	0.25	0.33	0.40	0.010	0.013	0.016
c	0.13	0.18	0.23	0.005	0.007	0.009
D	2.90	3.00	3.10	0.114	0.118	0.122
E	2.90	3.00	3.10	0.114	0.118	0.122
e	0.65 BSC			0.026 BSC		
L	0.40	0.55	0.70	0.016	0.021	0.028
HE	4.75	4.90	5.05	0.187	0.193	0.199

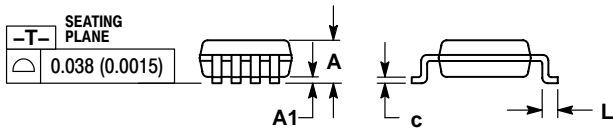

RECOMMENDED
SOLDERING FOOTPRINT*

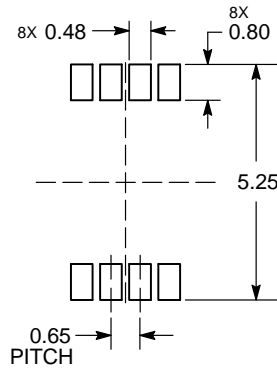

DIMENSION: MILLIMETERS

*For additional information on our Pb-Free strategy and soldering details, please download the ON Semiconductor Soldering and Mounting Techniques Reference Manual, SOLDERRM/D.

PACKAGE DIMENSIONS

SOIC-8 NB
CASE 751-07
ISSUE AK

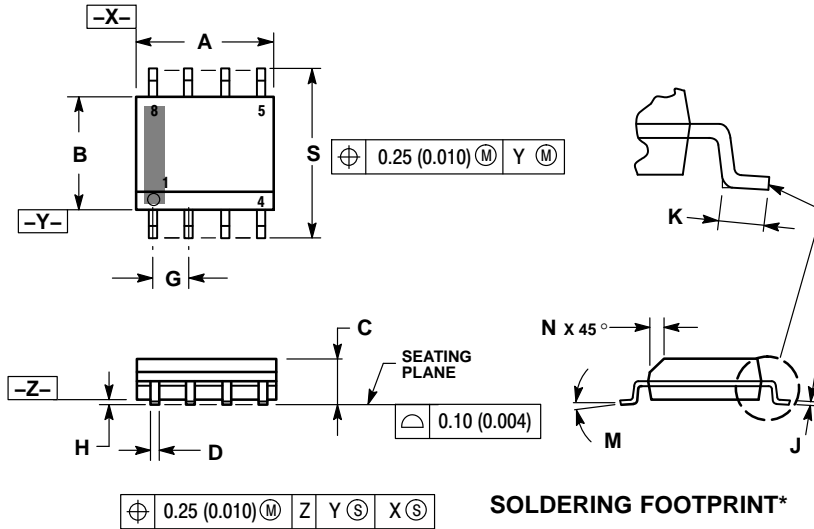

NOTES:

1. DIMENSIONING AND TOLERANCING PER ANSI Y14.5M, 1982.
2. CONTROLLING DIMENSION: MILLIMETER.
3. DIMENSION A AND B DO NOT INCLUDE MOLD PROTRUSION.
4. MAXIMUM MOLD PROTRUSION 0.15 (0.006) PER SIDE.
5. DIMENSION D DOES NOT INCLUDE DAMBAR PROTRUSION. ALLOWABLE DAMBAR PROTRUSION SHALL BE 0.127 (0.005) TOTAL IN EXCESS OF THE D DIMENSION AT MAXIMUM MATERIAL CONDITION.
6. 751-01 THRU 751-06 ARE OBSOLETE. NEW STANDARD IS 751-07.

DIM	MILLIMETERS		INCHES	
	MIN	MAX	MIN	MAX
A	4.80	5.00	0.189	0.197
B	3.80	4.00	0.150	0.157
C	1.35	1.75	0.053	0.069
D	0.33	0.51	0.013	0.020
G	1.27 BSC		0.050 BSC	
H	0.10	0.25	0.004	0.010
J	0.19	0.25	0.007	0.010
K	0.40	1.27	0.016	0.050
M	0° - 8°		0° - 8°	
N	0.25	0.50	0.010	0.020
S	5.80	6.20	0.228	0.244

SOLDERING FOOTPRINT*

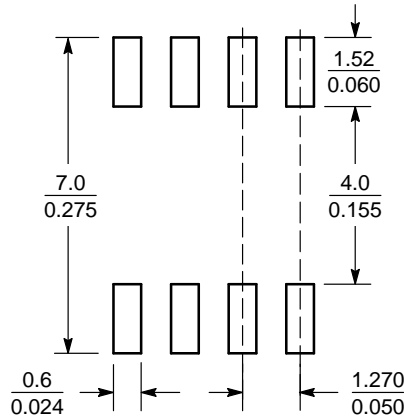

SCALE 6:1 $\left(\frac{\text{mm}}{\text{inches}}\right)$

*For additional information on our Pb-Free strategy and soldering details, please download the ON Semiconductor Soldering and Mounting Techniques Reference Manual, SOLDERRM/D.

PACKAGE DIMENSIONS

TSSOP-8
CASE 948S
ISSUE C

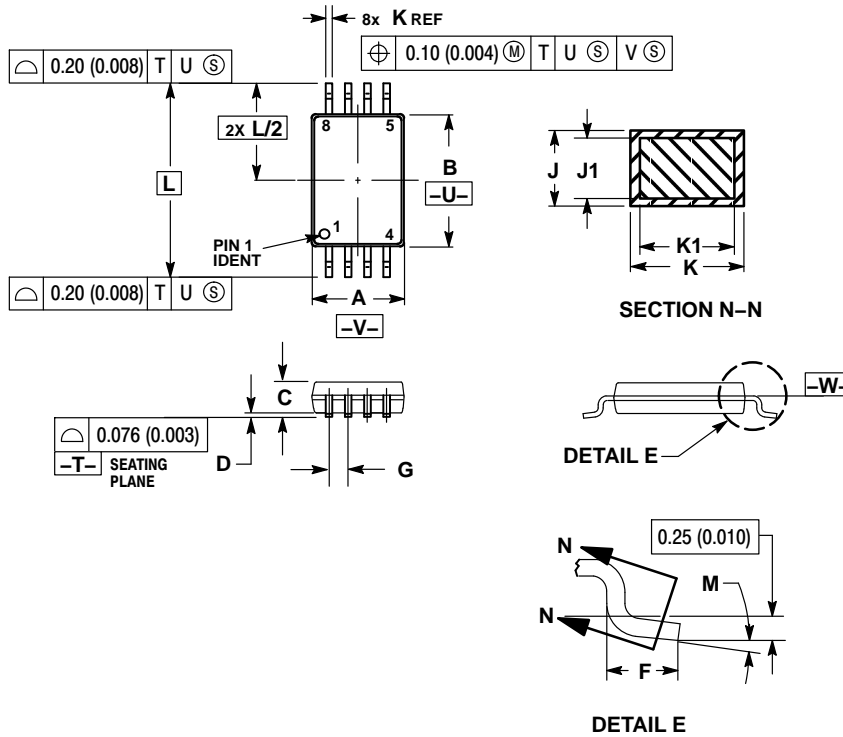

- NOTES:
1. DIMENSIONING AND TOLERANCING PER ANSI Y14.5M, 1982.
 2. CONTROLLING DIMENSION: MILLIMETER.
 3. DIMENSION A DOES NOT INCLUDE MOLD FLASH. PROTRUSIONS OR GATE BURRS. MOLD FLASH OR GATE BURRS SHALL NOT EXCEED 0.15 (0.006) PER SIDE.
 4. DIMENSION B DOES NOT INCLUDE INTERLEAD FLASH OR PROTRUSION. INTERLEAD FLASH OR PROTRUSION SHALL NOT EXCEED 0.25 (0.010) PER SIDE.
 5. TERMINAL NUMBERS ARE SHOWN FOR REFERENCE ONLY.
 6. DIMENSION A AND B ARE TO BE DETERMINED AT DATUM PLANE -W-.

DIM	MILLIMETERS		INCHES	
	MIN	MAX	MIN	MAX
A	2.90	3.10	0.114	0.122
B	4.30	4.50	0.169	0.177
C	---	1.10	---	0.043
D	0.05	0.15	0.002	0.006
F	0.50	0.70	0.020	0.028
G	0.65 BSC		0.026 BSC	
J	0.09	0.20	0.004	0.008
J1	0.09	0.16	0.004	0.006
K	0.19	0.30	0.007	0.012
K1	0.19	0.25	0.007	0.010
L	6.40 BSC		0.252 BSC	
M	0°	8°	0°	8°

PACKAGE DIMENSIONS

SOIC-14 NB
CASE 751A-03
ISSUE K

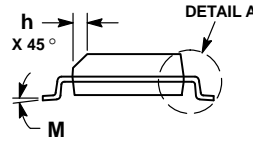
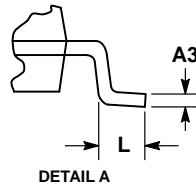
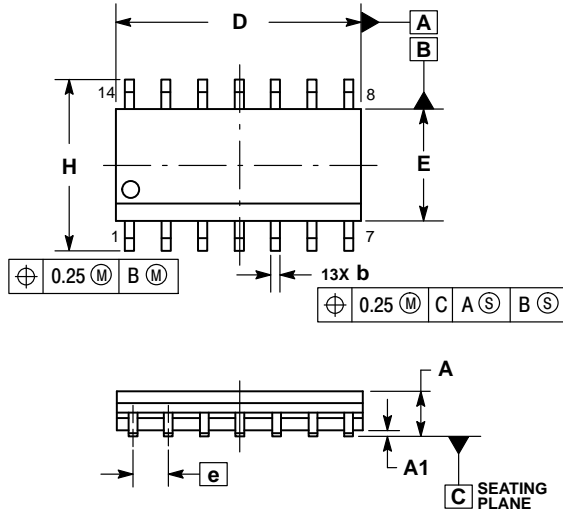

NOTES:

1. DIMENSIONING AND TOLERANCING PER ASME Y14.5M, 1994.
2. CONTROLLING DIMENSION: MILLIMETERS.
3. DIMENSION b DOES NOT INCLUDE DAMBAR PROTRUSION. ALLOWABLE PROTRUSION SHALL BE 0.13 TOTAL IN EXCESS OF AT MAXIMUM MATERIAL CONDITION.
4. DIMENSIONS D AND E DO NOT INCLUDE MOLD PROTRUSIONS.
5. MAXIMUM MOLD PROTRUSION 0.15 PER SIDE.

DIM	MILLIMETERS		INCHES	
	MIN	MAX	MIN	MAX
A	1.35	1.75	0.054	0.068
A1	0.10	0.25	0.004	0.010
A3	0.19	0.25	0.008	0.010
b	0.35	0.49	0.014	0.019
D	8.55	8.75	0.337	0.344
E	3.80	4.00	0.150	0.157
e	1.27 BSC		0.050 BSC	
H	5.80	6.20	0.228	0.244
h	0.25	0.50	0.010	0.019
L	0.40	1.25	0.016	0.049
M	0°	7°	0°	7°

SOLDERING FOOTPRINT*

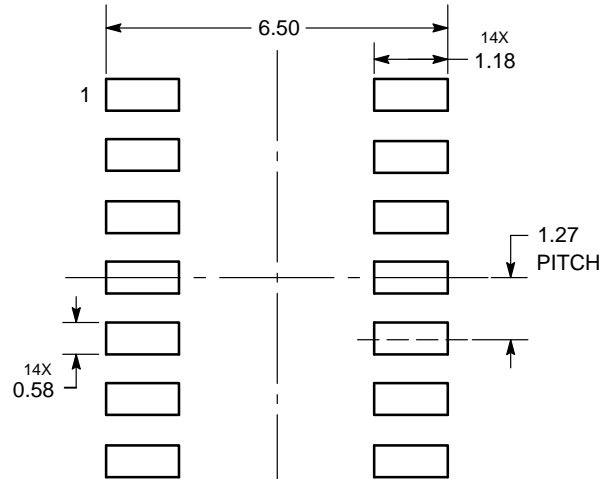

DIMENSIONS: MILLIMETERS

*For additional information on our Pb-Free strategy and soldering details, please download the ON Semiconductor Soldering and Mounting Techniques Reference Manual, SOLDERRM/D.

Micro8 is a trademark of International Rectifier.

ON Semiconductor and the are registered trademarks of Semiconductor Components Industries, LLC (SCILLC) or its subsidiaries in the United States and/or other countries. SCILLC owns the rights to a number of patents, trademarks, copyrights, trade secrets, and other intellectual property. A listing of SCILLC's product/patent coverage may be accessed at www.onsemi.com/site/pdf/Patent-Marking.pdf. SCILLC reserves the right to make changes without further notice to any products herein. SCILLC makes no warranty, representation or guarantee regarding the suitability of its products for any particular purpose, nor does SCILLC assume any liability arising out of the application or use of any product or circuit, and specifically disclaims any and all liability, including without limitation special, consequential or incidental damages. "Typical" parameters which may be provided in SCILLC data sheets and/or specifications can and do vary in different applications and actual performance may vary over time. All operating parameters, including "Typicals" must be validated for each customer application by customer's technical experts. SCILLC does not convey any license under its patent rights nor the rights of others. SCILLC products are not designed, intended, or authorized for use as components in systems intended for surgical implant into the body, or other applications intended to support or sustain life, or for any other application in which the failure of the SCILLC product could create a situation where personal injury or death may occur. Should Buyer purchase or use SCILLC products for any such unintended or unauthorized application, Buyer shall indemnify and hold SCILLC and its officers, employees, subsidiaries, affiliates, and distributors harmless against all claims, costs, damages, and expenses, and reasonable attorney fees arising out of, directly or indirectly, any claim of personal injury or death associated with such unintended or unauthorized use, even if such claim alleges that SCILLC was negligent regarding the design or manufacture of the part. SCILLC is an Equal Opportunity/Affirmative Action Employer. This literature is subject to all applicable copyright laws and is not for resale in any manner.

PUBLICATION ORDERING INFORMATION

LITERATURE FULFILLMENT:
Literature Distribution Center for ON Semiconductor
P.O. Box 5163, Denver, Colorado 80217 USA
Phone: 303-675-2175 or 800-344-3860 Toll Free USA/Canada
Fax: 303-675-2176 or 800-344-3867 Toll Free USA/Canada
Email: orderlit@onsemi.com

N. American Technical Support: 800-282-9855 Toll Free USA/Canada
Europe, Middle East and Africa Technical Support:
Phone: 421 33 790 2910
Japan Customer Focus Center
Phone: 81-3-5817-1050

ON Semiconductor Website: www.onsemi.com
Order Literature: <http://www.onsemi.com/orderlit>
For additional information, please contact your local Sales Representative

Компания «Океан Электроники» предлагает заключение долгосрочных отношений при поставках импортных электронных компонентов на взаимовыгодных условиях!

Наши преимущества:

- Поставка оригинальных импортных электронных компонентов напрямую с производств Америки, Европы и Азии, а так же с крупнейших складов мира;
- Широкая линейка поставок активных и пассивных импортных электронных компонентов (более 30 млн. наименований);
- Поставка сложных, дефицитных, либо снятых с производства позиций;
- Оперативные сроки поставки под заказ (от 5 рабочих дней);
- Экспресс доставка в любую точку России;
- Помощь Конструкторского Отдела и консультации квалифицированных инженеров;
- Техническая поддержка проекта, помощь в подборе аналогов, поставка прототипов;
- Поставка электронных компонентов под контролем ВП;
- Система менеджмента качества сертифицирована по Международному стандарту ISO 9001;
- При необходимости вся продукция военного и аэрокосмического назначения проходит испытания и сертификацию в лаборатории (по согласованию с заказчиком);
- Поставка специализированных компонентов военного и аэрокосмического уровня качества (Xilinx, Altera, Analog Devices, Intersil, Interpoint, Microsemi, Actel, Aeroflex, Peregrine, VPT, Syfer, Eurofarad, Texas Instruments, MS Kennedy, Miteq, Cobham, E2V, MA-COM, Hittite, Mini-Circuits, General Dynamics и др.);

Компания «Океан Электроники» является официальным дистрибьютором и эксклюзивным представителем в России одного из крупнейших производителей разъемов военного и аэрокосмического назначения «JONHON», а так же официальным дистрибьютором и эксклюзивным представителем в России производителя высокотехнологичных и надежных решений для передачи СВЧ сигналов «FORSTAR».



JONHON

«JONHON» (основан в 1970 г.)

Разъемы специального, военного и аэрокосмического назначения:

(Применяются в военной, авиационной, аэрокосмической, морской, железнодорожной, горно- и нефтедобывающей отраслях промышленности)

«FORSTAR» (основан в 1998 г.)

ВЧ соединители, коаксиальные кабели, кабельные сборки и микроволновые компоненты:

(Применяются в телекоммуникациях гражданского и специального назначения, в средствах связи, РЛС, а так же военной, авиационной и аэрокосмической отраслях промышленности).



Телефон: 8 (812) 309-75-97 (многоканальный)

Факс: 8 (812) 320-03-32

Электронная почта: ocean@oceanchips.ru

Web: <http://oceanchips.ru/>

Адрес: 198099, г. Санкт-Петербург, ул. Калинина, д. 2, корп. 4, лит. А