

Power MOSFET, 190 A



SOT-227

FEATURES

- Fully isolated package
- Very low on-resistance
- Fully avalanche rated
- Dynamic dV/dt rating
- Low drain to case capacitance
- Low internal inductance
- Optimized for SMPS applications
- Easy to use and parallel
- Industry standard outline
- Designed and qualified for industrial level
- UL approved file E78996
- Material categorization: For definitions of compliance please see www.vishay.com/doc?99912

RoHS
COMPLIANT

PRODUCT SUMMARY	
V_{DSS}	100 V
I_D DC	190 A
$R_{DS(on)}$	0.0065 Ω
Type	Modules - MOSFET
Package	SOT-227

DESCRIPTION

High current density power MOSFETs are paralleled into a compact, high power module providing the best combination of switching, ruggedized design, very low on-resistance and cost effectiveness.

The isolated SOT-227 package is preferred for all commercial-industrial applications at power dissipation levels to approximately higher than 500 W. The low thermal resistance and easy connection to the SOT-227 package contribute to its universal acceptance throughout the industry.

ABSOLUTE MAXIMUM RATINGS				
PARAMETER	SYMBOL	TEST CONDITIONS	MAX.	UNITS
Continuous drain current at V_{GS} 10 V	I_D	$T_C = 40\text{ }^\circ\text{C}$	190	A
		$T_C = 100\text{ }^\circ\text{C}$	130	
Pulsed drain current	I_{DM}		720	
Power dissipation	P_D	$T_C = 25\text{ }^\circ\text{C}$	568	W
Linear derating factor			2.7	W/ $^\circ\text{C}$
Gate to source voltage	V_{GS}		± 20	V
Single pulse avalanche energy	E_{AS} ⁽²⁾		700	mJ
Avalanche current	I_{AR} ⁽¹⁾		180	A
Repetitive avalanche energy	E_{AR} ⁽¹⁾		48	mJ
Peak diode recovery dV/dt	dV/dt ⁽³⁾		5.7	V/ns
Operating junction and storage temperature range	T_J, T_{Stg}		- 55 to + 150	$^\circ\text{C}$
Insulation withstand voltage (AC-RMS)	V_{ISO}		2.5	kV
Mounting torque		M4 screw	1.3	Nm

Notes

- (1) Repetitive rating; pulse width limited by maximum junction temperature.
- (2) Starting $T_J = 25\text{ }^\circ\text{C}$, $L = 43\text{ }\mu\text{H}$, $R_g = 25\text{ }\Omega$, $I_{AS} = 180\text{ A}$.
- (3) $I_{SD} \leq 180\text{ A}$, $dI/dt \leq 83\text{ A}/\mu\text{s}$, $V_{DD} \leq V_{(BR)DSS}$, $T_J \leq 150\text{ }^\circ\text{C}$.



THERMAL - MECHANICAL SPECIFICATIONS						
PARAMETER	SYMBOL	TEST CONDITIONS	MIN.	TYP.	MAX.	UNITS
Junction and storage temperature range	T_J, T_{Stg}		- 55	-	150	°C
Junction to case	R_{thJC}		-	-	0.22	°C/W
Case to heatsink	R_{thCS}	Flat, greased surface	-	0.05	-	
Weight			-	30	-	g
Mounting torque			-	-	1.3	Nm
Case style			SOT-227			

ELECTRICAL CHARACTERISTICS ($T_J = 25\text{ °C}$ unless otherwise noted)						
PARAMETER	SYMBOL	TEST CONDITIONS	MIN.	TYP.	MAX.	UNITS
Drain to source breakdown voltage	$V_{(BR)DSS}$	$V_{GS} = 0\text{ V}, I_D = 250\text{ }\mu\text{A}$	100	-	-	V
Breakdown voltage temperature coefficient	$\Delta V_{(BR)DSS}/\Delta T_J$	Reference to $25\text{ °C}, I_D = 1\text{ mA}$	-	0.093	-	V/°C
Static drain to source on-resistance	$R_{DS(on)}$	$V_{GS} = 10\text{ V}, I_D = 180\text{ A}$	-	0.0054	0.0065	Ω
Gate threshold voltage	$V_{GS(th)}$	$V_{DS} = V_{GS}, I_D = 250\text{ }\mu\text{A}$	2.0	3.3	4.35	V
Forward transconductance	g_{fs}	$V_{DS} = 25\text{ V}, I_D = 180\text{ A}$	93	-	-	S
Drain to source leakage current	I_{DSS}	$V_{DS} = 100\text{ V}, V_{GS} = 0\text{ V}$	-	-	50	μA
		$V_{DS} = 80\text{ V}, V_{GS} = 0\text{ V}, T_J = 125\text{ °C}$	-	-	500	
Gate to source forward leakage	I_{GSS}	$V_{GS} = 20\text{ V}$	-	-	200	nA
		$V_{GS} = -20\text{ V}$	-	-	- 200	
Total gate charge	Q_g	$I_D = 180\text{ A}$	-	250	-	nC
Gate to source charge	Q_{gs}	$V_{DS} = 80\text{ V}$	-	40	-	
Gate to drain ("Miller") charge	Q_{gd}	$V_{GS} = 10\text{ V}$	-	110	-	
Turn-on delay time	$t_{d(on)}$	$V_{DD} = 50\text{ V}$ $I_D = 180\text{ A}$ $R_g = 2.0\text{ }\Omega$ (internal) $R_D = 0.27\text{ }\Omega$	-	45	-	ns
Rise time	t_r		-	351	-	
Turn-off delay time	$t_{d(off)}$		-	181	-	
Fall time	t_f		-	335	-	
Internal source inductance	L_S	Between lead, and center of die contact	-	5.0	-	nH
Input capacitance	C_{iss}	$V_{GS} = 0\text{ V}$ $V_{DS} = 25\text{ V}$ $f = 1.0\text{ MHz}$	-	10 700	-	pF
Output capacitance	C_{oss}		-	2800	-	
Reverse transfer capacitance	C_{rss}		-	1300	-	

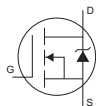
SOURCE-DRAIN RATINGS AND CHARACTERISTICS						
PARAMETER	SYMBOL	TEST CONDITIONS	MIN.	TYP.	MAX.	UNITS
Continuous source current (body diode)	I_S	MOSFET symbol showing the integral reverse p-n junction diode. 	-	-	190	A
Pulsed source current (body diode)	I_{SM}		-	-	740	
Diode forward voltage	V_{SD}	$T_J = 25\text{ °C}, I_S = 180\text{ A}, V_{GS} = 0\text{ V}$	-	1.0	1.3	V
Reverse recovery time	t_{rr}	$T_J = 25\text{ °C}, I_F = 180\text{ A}, di/dt = 100\text{ A}/\mu\text{s}$	-	300	-	ns
Reverse recovery charge	Q_{rr}		-	2.6	-	μC
Forward turn-on time	t_{on}	Intrinsic turn-on time is negligible (turn-on is dominated by $L_S + L_D$)				

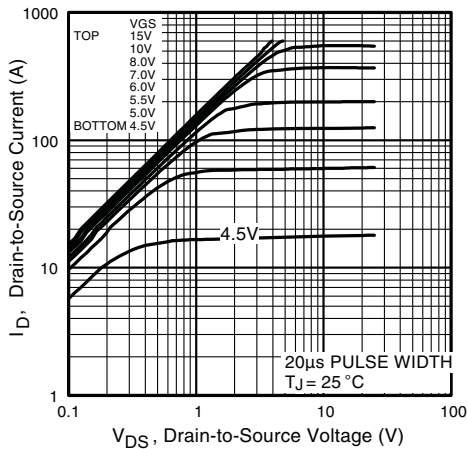

Fig. 1 - Typical Output Characteristics

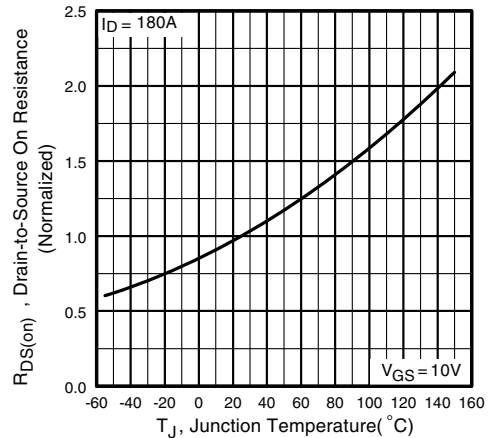

Fig. 4 - Normalized On-Resistance vs. Temperature

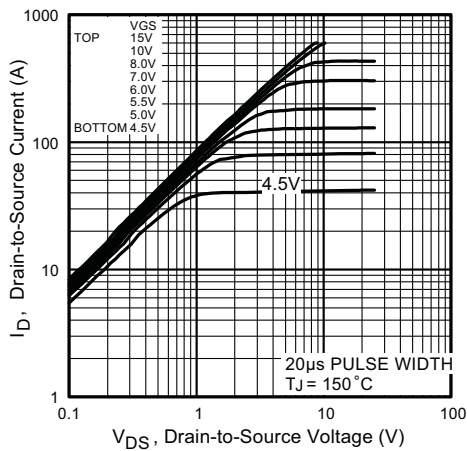

Fig. 2 - Typical Output Characteristics

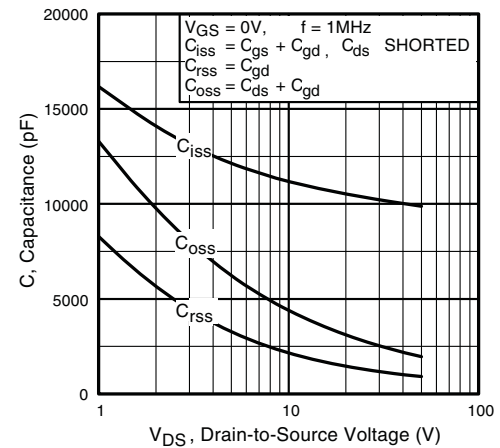

Fig. 5 - Typical Capacitance vs. Drain to Source Voltage

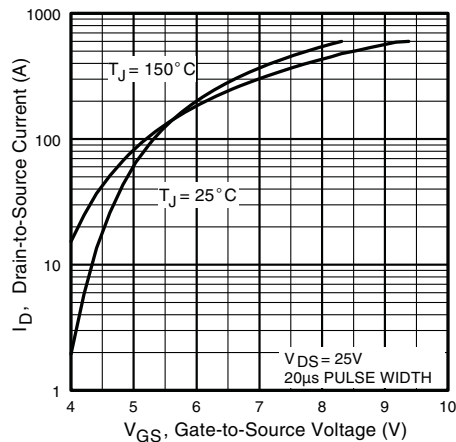

Fig. 3 - Typical Transfer Characteristics

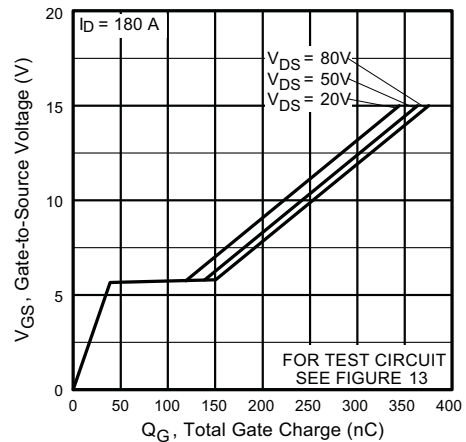

Fig. 6 - Typical Gate Charge vs. Gate to Source Voltage

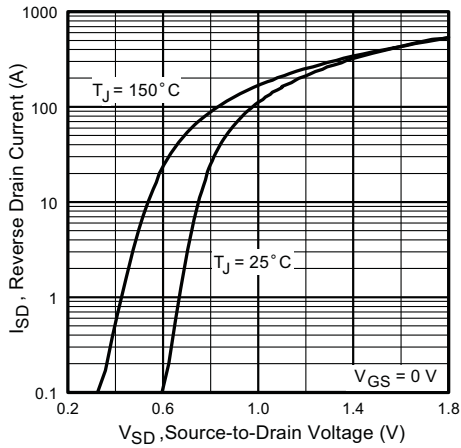

Fig. 7 - Typical Source Drain Diode Forward Voltage

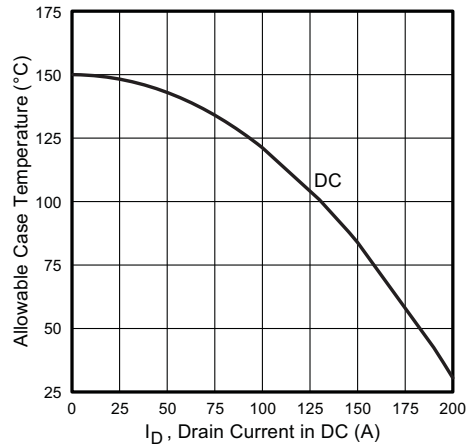

Fig. 9 - Maximum Drain Current vs. Case Temperature

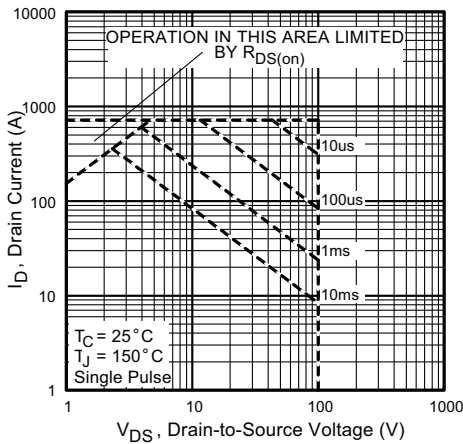

Fig. 8 - Maximum Safe Operating Area

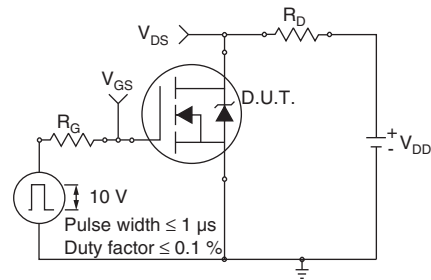

Fig. 10a - Switching Time Test Circuit

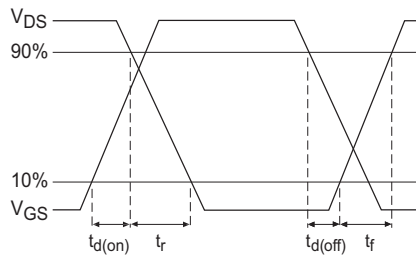

Fig. 10b - Switching Time Waveforms

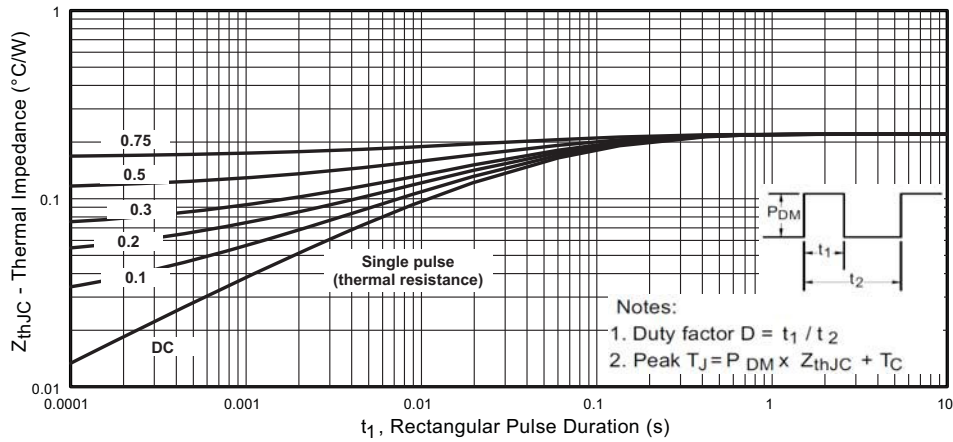

Fig. 11 - Maximum Effective Transient Thermal Impedance, Junction to Case

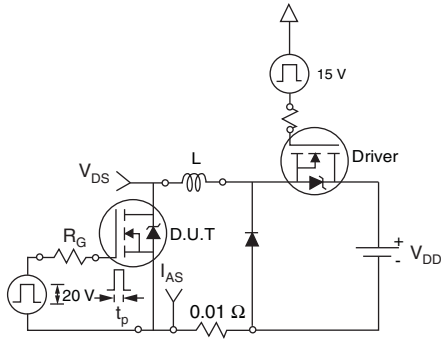

Fig. 12a - Unclamped Inductive Test Circuit

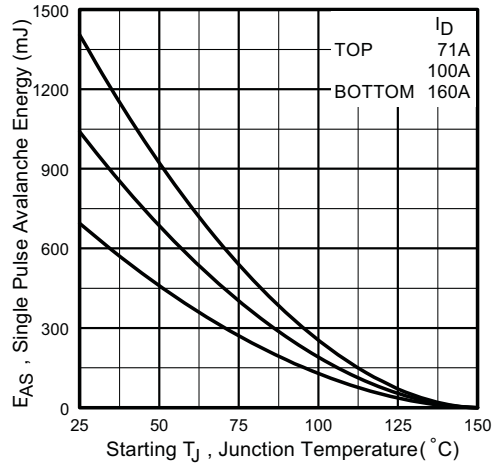

Fig. 12c - Maximum Avalanche Energy vs. Drain Current

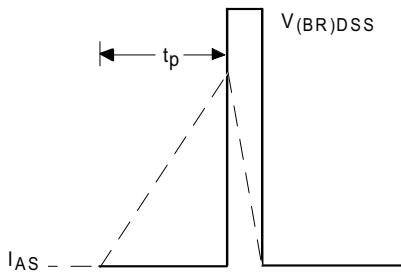

Fig. 12b - Unclamped Inductive Waveforms

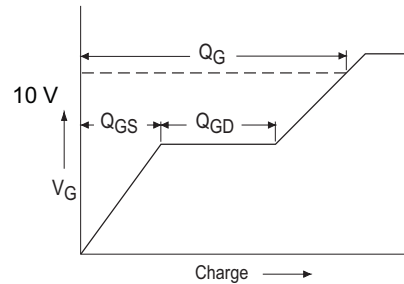

Fig. 13a - Basic Gate Charge Waveform

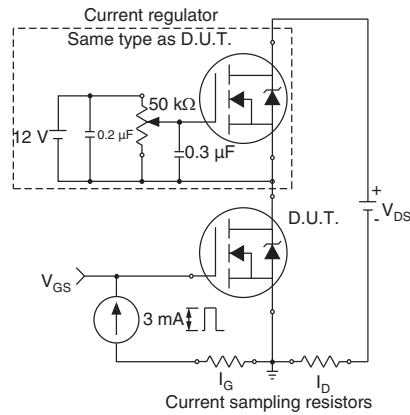

Fig. 13b - Gate Charge Test Circuit

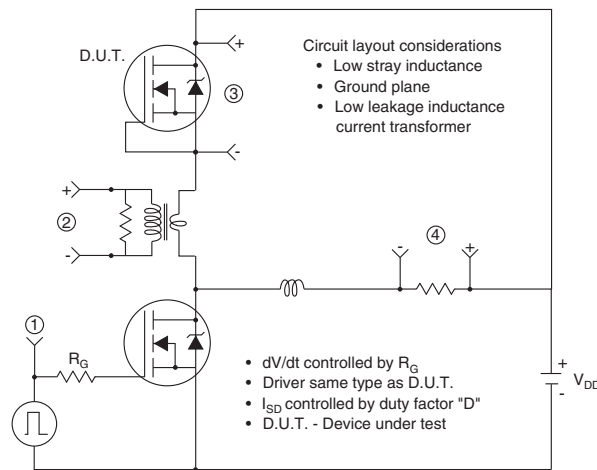
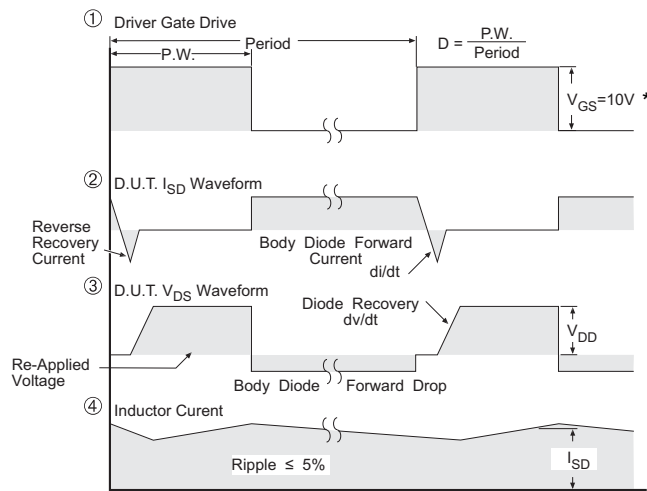

Fig. 13c - Peak Diode Recovery dV/dt Test Circuit



* $V_{GS} = 5V$ for Logic Level Devices

Fig. 14 - For N-Channel Power MOSFETs

ORDERING INFORMATION TABLE

Device code	VS-	F	B	190	S	A	10		
	①	②	③	④	⑤	⑥	⑦		
	1	-	Vishay Semiconductors product	2	-	Power MOSFET	3	-	Generation 5 MOSFET
	4	-	Current rating (190 = 190 A)	5	-	Single switch	6	-	Package indicator (SOT-227)
	7	-	Voltage rating (10 = 100 V)						

CIRCUIT CONFIGURATION		
CIRCUIT	CIRCUIT CONFIGURATION CODE	CIRCUIT DRAWING
Single switch	S	

LINKS TO RELATED DOCUMENTS	
Dimensions	www.vishay.com/doc?95423
Packaging information	www.vishay.com/doc?95425



SOT-227 Generation II

DIMENSIONS in millimeters (inches)

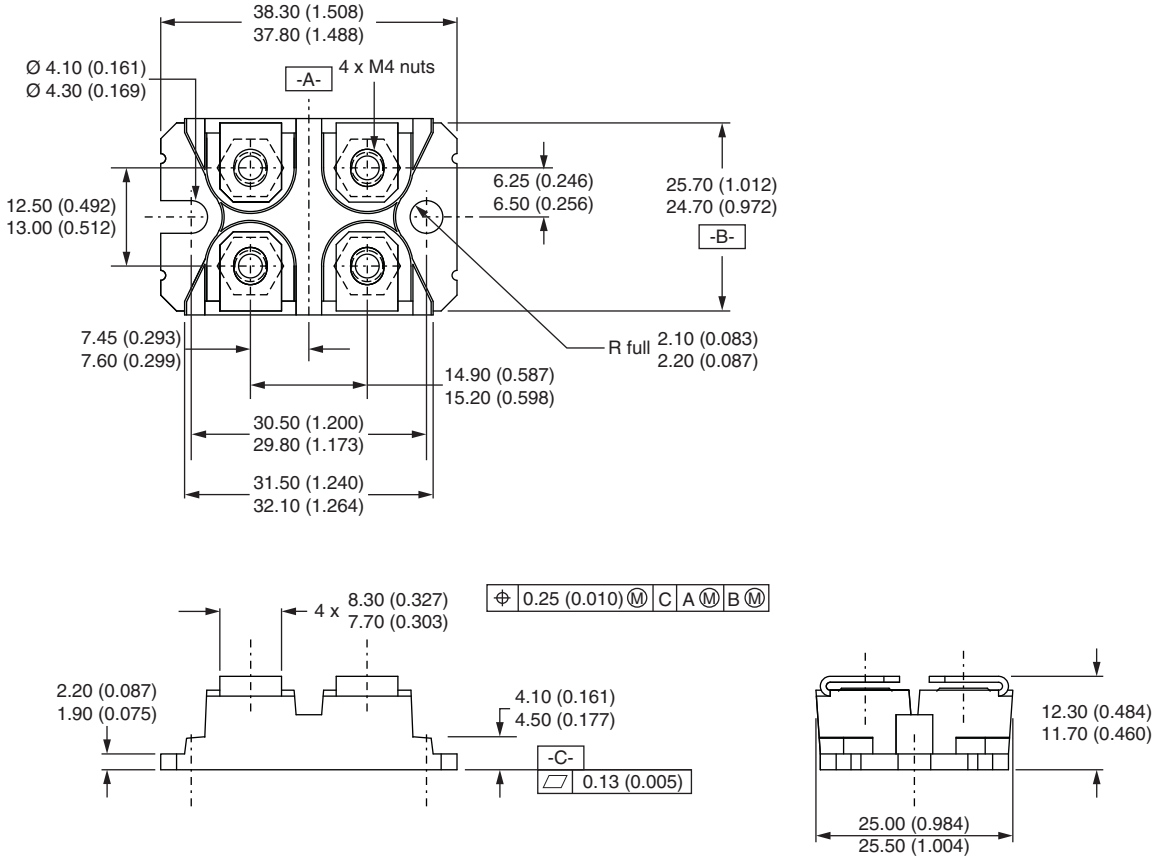

Note

- Controlling dimension: millimeter



Disclaimer

ALL PRODUCT, PRODUCT SPECIFICATIONS AND DATA ARE SUBJECT TO CHANGE WITHOUT NOTICE TO IMPROVE RELIABILITY, FUNCTION OR DESIGN OR OTHERWISE.

Vishay Intertechnology, Inc., its affiliates, agents, and employees, and all persons acting on its or their behalf (collectively, "Vishay"), disclaim any and all liability for any errors, inaccuracies or incompleteness contained in any datasheet or in any other disclosure relating to any product.

Vishay makes no warranty, representation or guarantee regarding the suitability of the products for any particular purpose or the continuing production of any product. To the maximum extent permitted by applicable law, Vishay disclaims (i) any and all liability arising out of the application or use of any product, (ii) any and all liability, including without limitation special, consequential or incidental damages, and (iii) any and all implied warranties, including warranties of fitness for particular purpose, non-infringement and merchantability.

Statements regarding the suitability of products for certain types of applications are based on Vishay's knowledge of typical requirements that are often placed on Vishay products in generic applications. Such statements are not binding statements about the suitability of products for a particular application. It is the customer's responsibility to validate that a particular product with the properties described in the product specification is suitable for use in a particular application. Parameters provided in datasheets and/or specifications may vary in different applications and performance may vary over time. All operating parameters, including typical parameters, must be validated for each customer application by the customer's technical experts. Product specifications do not expand or otherwise modify Vishay's terms and conditions of purchase, including but not limited to the warranty expressed therein.

Except as expressly indicated in writing, Vishay products are not designed for use in medical, life-saving, or life-sustaining applications or for any other application in which the failure of the Vishay product could result in personal injury or death. Customers using or selling Vishay products not expressly indicated for use in such applications do so at their own risk. Please contact authorized Vishay personnel to obtain written terms and conditions regarding products designed for such applications.

No license, express or implied, by estoppel or otherwise, to any intellectual property rights is granted by this document or by any conduct of Vishay. Product names and markings noted herein may be trademarks of their respective owners.

Material Category Policy

Vishay Intertechnology, Inc. hereby certifies that all its products that are identified as RoHS-Compliant fulfill the definitions and restrictions defined under Directive 2011/65/EU of The European Parliament and of the Council of June 8, 2011 on the restriction of the use of certain hazardous substances in electrical and electronic equipment (EEE) - recast, unless otherwise specified as non-compliant.

Please note that some Vishay documentation may still make reference to RoHS Directive 2002/95/EC. We confirm that all the products identified as being compliant to Directive 2002/95/EC conform to Directive 2011/65/EU.

Vishay Intertechnology, Inc. hereby certifies that all its products that are identified as Halogen-Free follow Halogen-Free requirements as per JEDEC JS709A standards. Please note that some Vishay documentation may still make reference to the IEC 61249-2-21 definition. We confirm that all the products identified as being compliant to IEC 61249-2-21 conform to JEDEC JS709A standards.

Компания «Океан Электроники» предлагает заключение долгосрочных отношений при поставках импортных электронных компонентов на взаимовыгодных условиях!

Наши преимущества:

- Поставка оригинальных импортных электронных компонентов напрямую с производств Америки, Европы и Азии, а так же с крупнейших складов мира;
- Широкая линейка поставок активных и пассивных импортных электронных компонентов (более 30 млн. наименований);
- Поставка сложных, дефицитных, либо снятых с производства позиций;
- Оперативные сроки поставки под заказ (от 5 рабочих дней);
- Экспресс доставка в любую точку России;
- Помощь Конструкторского Отдела и консультации квалифицированных инженеров;
- Техническая поддержка проекта, помощь в подборе аналогов, поставка прототипов;
- Поставка электронных компонентов под контролем ВП;
- Система менеджмента качества сертифицирована по Международному стандарту ISO 9001;
- При необходимости вся продукция военного и аэрокосмического назначения проходит испытания и сертификацию в лаборатории (по согласованию с заказчиком);
- Поставка специализированных компонентов военного и аэрокосмического уровня качества (Xilinx, Altera, Analog Devices, Intersil, Interpoint, Microsemi, Actel, Aeroflex, Peregrine, VPT, Syfer, Eurofarad, Texas Instruments, MS Kennedy, Miteq, Cobham, E2V, MA-COM, Hittite, Mini-Circuits, General Dynamics и др.);

Компания «Океан Электроники» является официальным дистрибьютором и эксклюзивным представителем в России одного из крупнейших производителей разъемов военного и аэрокосмического назначения «JONHON», а так же официальным дистрибьютором и эксклюзивным представителем в России производителя высокотехнологичных и надежных решений для передачи СВЧ сигналов «FORSTAR».



JONHON

«JONHON» (основан в 1970 г.)

Разъемы специального, военного и аэрокосмического назначения:

(Применяются в военной, авиационной, аэрокосмической, морской, железнодорожной, горно- и нефтедобывающей отраслях промышленности)

«FORSTAR» (основан в 1998 г.)

ВЧ соединители, коаксиальные кабели, кабельные сборки и микроволновые компоненты:

(Применяются в телекоммуникациях гражданского и специального назначения, в средствах связи, РЛС, а так же военной, авиационной и аэрокосмической отраслях промышленности).



Телефон: 8 (812) 309-75-97 (многоканальный)

Факс: 8 (812) 320-03-32

Электронная почта: ocean@oceanchips.ru

Web: <http://oceanchips.ru/>

Адрес: 198099, г. Санкт-Петербург, ул. Калинина, д. 2, корп. 4, лит. А