

PI-7302-061214

Figure 2. Functional Block Diagram.

Pin Functional Description

DRAIN (D) Pin:

Power MOSFET drain connection. It also provides internal operating current during start-up and in steady-state operation.

BYPASS (BP) Pin:

Connection point for the external 1 μ F bypass capacitor connected to the internally generated 6 V supply.

FEEDBACK (FB) Pin:

Controls switching of the power MOSFET during normal operation. This pin senses the AC voltage on the bias winding. Input is used to regulate both the output voltage in CV mode and output current in CC mode based on voltage across the bias winding in the flyback portion of the switching cycle. The internal inductance correction circuit uses voltage on the bias winding during forward part of the switching cycle to sense the bulk capacitor voltage.

SOURCE (S) Pin:

Connected to the MOSFET source and is used for high-voltage power and control circuit common returns.

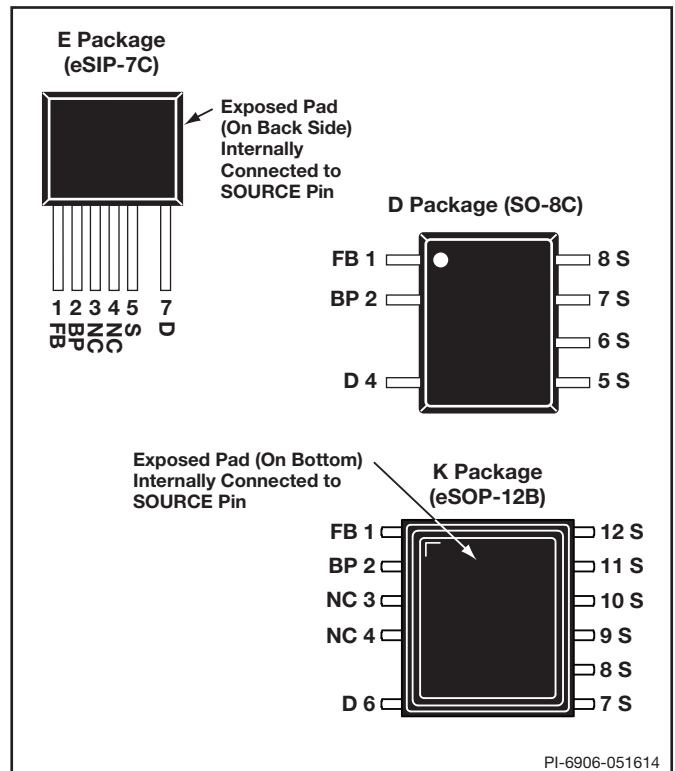

PI-6906-051614

Figure 3. Pin Configuration.

LYTSwitch-2 Functional Description

The LYTSwitch-2 IC combines a high-voltage power MOSFET switch with a power supply controller in one device. Similar to the LinkSwitch-LP and TinySwitch-III ICs it uses an ON/OFF control to regulate the output voltage. In addition, the switching frequency is modulated to regulate the output current to provide a constant current characteristic. The LYTSwitch-2 controller consists of an oscillator, feedback (sense and logic) circuit, 6 V regulator, over-temperature protection, frequency jittering, current limit circuit, leading-edge blanking, inductance correction circuitry, frequency control for constant current regulation and ON/OFF state-machine for CV control.

Inductance Correction Circuitry

If the primary magnetizing inductance is either too high or low the converter will automatically compensate for this by adjusting the oscillator frequency. Since this controller is designed to operate in discontinuous-conduction mode the output power is directly proportional to the set primary inductance and its tolerance can be completely compensated with adjustments to the switching frequency.

Constant Current (CC) Operation

As the output voltage and therefore the flyback voltage across the bias winding ramps up, the FEEDBACK pin voltage increases. The switching frequency is adjusted as the FEEDBACK pin voltage increases to provide a constant output current regulation. The constant current circuit and the inductance correction circuit are designed to operate concurrently in the CC region.

Constant Voltage (CV) Operation

As the FEEDBACK pin approaches 2 V from the constant current regulation mode, the power supply transitions into CV operation. The switching frequency at this point is at its maximum value, corresponding to the peak power point of the CV/CC characteristic. The controller regulates the FEEDBACK pin voltage to remain at FEEDBACK pin threshold (V_{FBTH}) using an ON/OFF state-machine. The FEEDBACK pin voltage is sampled 2.5 μ s after the turn-off of the high-voltage switch. At light loads the current limit is also reduced to decrease the transformer flux density and the FEEDBACK pin sampling is done earlier.

Auto-Restart and Open-Loop Protection

In the event of a fault condition such as an output short or an open-loop condition the LYTSwitch-2 IC enters into an appropriate protection mode.

In the event the FEEDBACK pin voltage during the flyback period falls below 0.7 V before the FEEDBACK pin sampling delay ($\sim 2.5 \mu$ s) for a duration in excess of ~ 450 ms (auto-restart on-time (t_{AR-ON})) the converter enters into auto-restart, wherein the power MOSFET is disabled for 1.2 seconds. The auto-restart alternately enables and disables the switching of the power MOSFET until the fault condition is removed.

In addition to the conditions for auto-restart described above, if the sensed FEEDBACK pin current during the forward period of the conduction cycle (switch "on" time) falls below 120 μ A, the converter annunciates this as an open-loop condition (top resistor in potential divider is open or missing) and reduces the auto-restart time from 450 ms to approximately 6 clock cycles (90 μ s), whilst keeping the disable period of 2 seconds.

Over-Temperature Protection

The thermal shutdown circuitry senses the die temperature. The threshold is set at 142 $^{\circ}$ C typical with a 60 $^{\circ}$ C hysteresis. When the die temperature rises above this threshold (142 $^{\circ}$ C) the power MOSFET is disabled and remains disabled until the die temperature falls by 60 $^{\circ}$ C, at which point the MOSFET is re-enabled.

Current Limit

The current limit circuit senses the current in the power MOSFET. When this current exceeds the internal threshold (I_{LIMIT}), the power MOSFET is turned off for the remainder of that cycle. The leading edge blanking circuit inhibits the current limit comparator for a short time (t_{LEB}) after the power MOSFET is turned on. This leading edge blanking time has been set so that current spikes caused by capacitance and rectifier reverse recovery time will not cause premature termination of the MOSFET conduction. The LYTSwitch-2 IC also contains a "di/dt" correction feature to minimize CC variation across the input line range.

6 V Regulator

The 6 V regulator charges the bypass capacitor connected to the BYPASS pin to 6 V by drawing a current from the voltage on the DRAIN pin, whenever the MOSFET is off. The BYPASS pin is the internal supply voltage node. When the MOSFET is on, the device runs off of the energy stored in the bypass capacitor. Extremely low power consumption of the internal circuitry allows the LYTSwitch-2 IC to operate continuously from the current drawn from the DRAIN pin. A bypass capacitor value of 1 μ F is sufficient for both high frequency decoupling and energy storage.

Output Rectification

The output from the transformer is rectified by D3, a 1 A, 400 V ultrafast recovery type diode (for higher efficiency), and filtered by C6. In this application C6 was sized to meet a (typical) ripple requirement of less than 10% without the need for an additional LC post filter.

A pre-load resistor R10 was employed to discharge the output capacitor and extinguish the LED light immediately after turn-off. The resistor will also keep the output from rising higher than the permitted maximum output voltage (usually determined by the output capacitor voltage rating) when the load is disconnected.

Output Regulation

The LYTSwitch-2 family regulates the output using ON/OFF control in the constant voltage (CV) regulation region of the output characteristic and frequency control for the constant current (CC) region. The feedback resistors (R7 and R8) were selected using standard 1% resistors to center both the nominal output voltage and constant current regulation thresholds. Resistor R6 acts as filter to limit the voltage spike (caused by the coupling of the bias winding to the primary winding), improving regulation.

Key Application Considerations

Output Power Table

The data sheet maximum output power table (Table 1) represents the maximum practical continuous output power that can be obtained under the following assumed conditions:

1. The minimum DC bus voltage is 100 V at 90 VAC input. The value of the input capacitance should be made large enough to meet this requirement for AC input designs – typically 2-3 $\mu\text{F}/\text{W}$ for low-line or universal input designs and 1-2 $\mu\text{F}/\text{W}$ for high-line input designs.
2. The secondary output rectifier diode should withstand peak inverse voltage (PIV) for 55 V output voltage for open load condition.
3. Assume efficiency of >80%.
4. Discontinuous mode operation ($K_p > 1.3$).
5. The LYTSwitch-2 part is either board mounted with SOURCE pins soldered to a sufficient area of copper to keep the SOURCE pin temperature at or below 100 °C, or (in the case of the E package) attached to a sufficiently sized heat sink to limit device temperature to below 110 °C.
6. Ambient temperature of less than 50 °C for open frame designs and an internal enclosure temperature of 60 °C for enclosed ballast-type designs.

Note: Higher output powers are achievable if an output CC tolerance > $\pm 10\%$ is acceptable, and allowing the device to be operated at a higher SOURCE pin temperature.

Output Tolerance

LYTSwitch-2 K and E package parts provides an overall CC mode output current tolerance of $\pm 5\%$ including line voltage, normal board-to-board component variation and across a temperature range of 0 °C to 110 °C. For the D package (SO-8) additional CC variance may occur due to stress caused by

manufacturing (i.e. solder-wave immersion or I_R reflow). A sample power supply build is recommended to verify production tolerances for each design.

BYPASS Pin Capacitor Selection

A 1 μF BYPASS pin capacitor is recommended. The capacitor voltage rating should be greater than 7 V. The capacitor can be ceramic or electrolytic but tolerance of capacitor should be $\leq \pm 50\%$. The capacitor must be physically located close to the LYTSwitch-2 BYPASS pin for effective noise decoupling.

LYTSwitch-2 Layout Considerations

Circuit Board Layout

The LYTSwitch-2 family of ICs present a highly integrated power supply solution that integrates, both, the controller and the high-voltage power MOSFET onto a single die. The presence of high switching currents and voltages together with analog signals makes it especially important to follow good PCB design practice to ensure stable and trouble free operation of the power supply. See Figures 5 and 6 for a recommended circuit board layout for LYTSwitch-2.

When designing a printed circuit board layout for the LYTSwitch-2 based power supply, it is important to follow these guidelines:

Single Point Grounding

Use a single point (Kelvin) connection at the negative terminal of the input filter capacitor for the LYTSwitch-2 SOURCE pin and bias winding return. This improves surge capabilities by returning surge currents from the bias winding directly to the input filter capacitor.

Bypass Capacitor

The BYPASS pin capacitor should be located as close as possible to the SOURCE and BYPASS pins for effective noise decoupling.

Feedback Resistors

Place the feedback resistors (R7 and R8) very close to the FEEDBACK pin of the LYTSwitch-2 device. This minimizes noise coupling.

Thermal Considerations (D and K Package)

The copper area connected to the SOURCE pins provides heat sinking. A good estimate of expected power dissipation is to assume that the LYTSwitch-2 will dissipate 5% of the output power. Provide enough copper area to keep the SOURCE pin temperature below 100 °C. Higher temperatures are allowable but output current (CC) tolerance will increase. In this case a maximum SOURCE pin temperature below 100 °C is recommended to provide margin for part-to-part $R_{DS(ON)}$ variation.

Secondary Loop Area

To minimize leakage inductance and EMI the area of the loop contained within the connections between the secondary winding (T1), the output diode (D3) and the output filter capacitor (C6) should be minimized. In addition, sufficient copper area should be to the rectifier diode for heat sinking preferably connected to the quiet cathode terminal. A large anode area can increase high frequency radiated EMI.

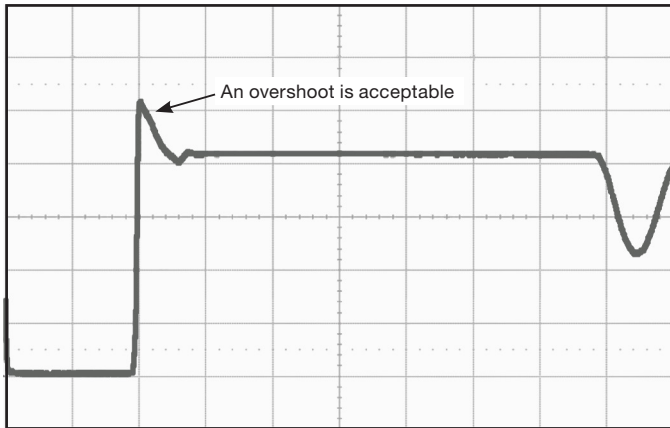

Figure 7. Desired Drain Voltage Waveform with Minimal Leakage Ringing Undershoot.

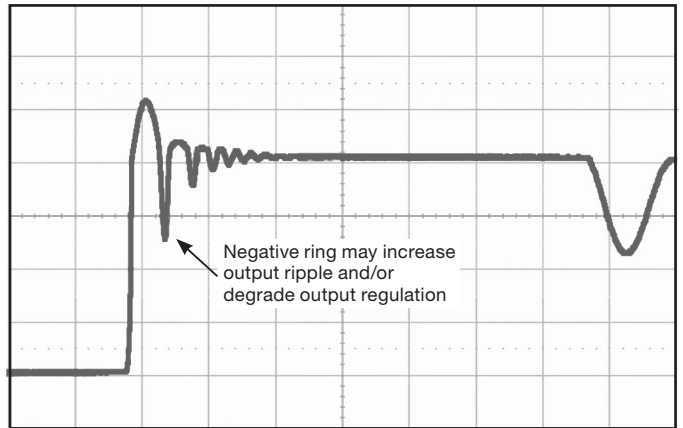

Figure 8. Undesirable Drain Voltage Waveform with Large Leakage Ring Undershoot.

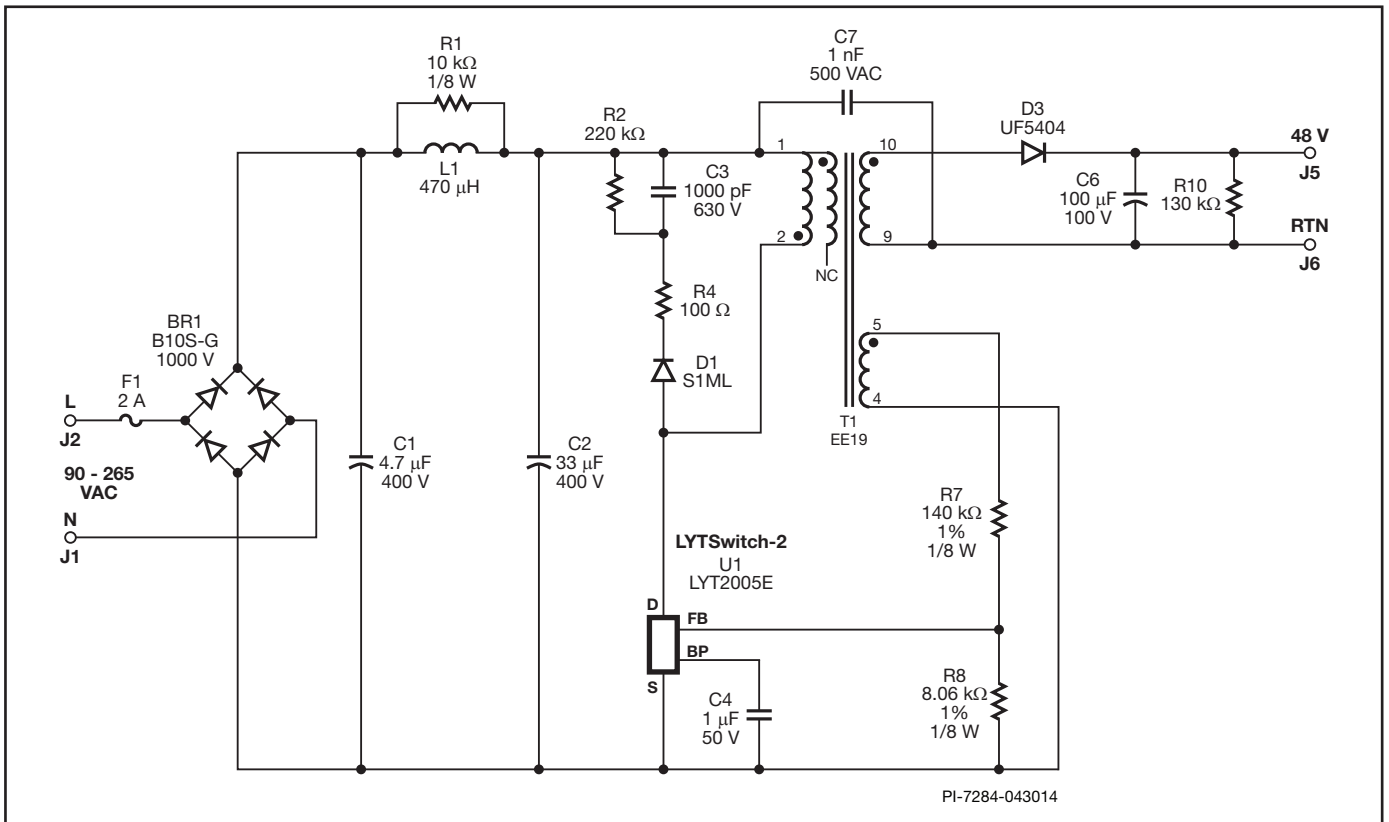

Figure 9. Example Schematic of LYTSwitch-2 Flyback Power Supply without Bias Supply.

Quick Design Checklist

As with any power supply design, all LYTSwitch-2 family designs should be verified on the bench to make sure that component specifications are not exceeded under worst-case conditions. The following set of tests is strongly recommended:

1. Maximum drain voltage – Verify that the peak V_{DS} does not exceed 680 V at the highest input voltage and maximum output power.
2. Drain current – At maximum ambient temperature, maximum and minimum input voltage and maximum output load, review drain current waveforms at start-up for any signs of transformer saturation or excessive leading edge current spikes. LYTSwitch-2 devices have a leading edge blanking time to prevent premature termination of the ON-cycle, but limit leading edge spikes to less than the maximum time as specified in the data sheet.
3. Thermal check – At maximum output power, for both minimum and maximum input voltage and maximum ambient temperature; verify that temperature limits are not exceeded for LYTSwitch-2, transformer, output diodes and output capacitors. Thermal margin should be provided to allow for part-to-part variation in the $R_{DS(ON)}$ of the LYTSwitch-2 device. For optimum regulation, a SOURCE pin temperature of 90 °C is recommended.

Design Tools

Up-to-date information on design tools can be found at the Power Integrations web site: www.power.com

Absolute Maximum Ratings^(1,6)

DRAIN Voltage	-0.3 V to 725 V
DRAIN Pin Peak Current ⁽⁵⁾ : LYT2001	400 (600) mA ⁽²⁾
LYT2002	504 (750) mA ⁽²⁾
LYT2003	654 (980) mA ⁽²⁾
LYT2004	686 (1029) mA ⁽²⁾
LYT2005	784 (1176) mA ⁽²⁾
Peak Negative Pulsed Drain Current	-100 mA ⁽³⁾
FEEDBACK Pin Voltage	-0.3 to 9 V
FEEDBACK Pin Current.....	100 mA
BYPASS Pin Voltage	-0.3 to 9 V
Storage Temperature	-65 to 150 °C
Operating Junction Temperature ⁽⁴⁾	-40 to 150 °C
Lead Temperature ⁽⁵⁾	260 °C

Notes:

1. All voltages referenced to SOURCE, T_A = 25 °C.
2. Higher peak Drain current allowed while Drain to Source voltage does not exceed 400 V.
3. Duration not to exceed 2 ms.
4. Normally limited by internal circuitry.
5. 1/16 in. from case for 5 seconds.
6. Absolute Maximum Ratings specified may be applied, one at a time without causing permanent damage to the product. Exposure to Absolute Maximum Ratings for extended periods of time may affect product reliability.

Thermal Resistance

Thermal Resistance: D Package:

(θ _{JA})	100 °C/W ⁽²⁾ , 80 °C/W ⁽³⁾
(θ _{JC}) ⁽¹⁾	30 °C/W
E Package	
(θ _{JA})	105 °C/W ⁽⁴⁾
(θ _{JC})	2 °C/W ⁽⁵⁾
K Package	
(θ _{JA})	45 °C/W ⁽⁶⁾ , 38 °C/W ⁽⁷⁾
(θ _{JC})	2 °C/W ⁽⁵⁾

Notes:

1. Measured on pin 8 (SOURCE) close to plastic interface.
2. Soldered to 0.36 sq. in. (232 mm²), 2 oz. (610 g/m²) copper clad.
3. Soldered to 1 sq. in. (645 mm²), 2 oz. (610 g/m²) copper clad.
4. Free standing with no heat sink.
5. Measured at the back surface of tab.
6. Soldered (including exposed pad for K package) to typical application PCB with a heat sinking area of 0.36 sq. in. (232 mm²), 2 oz. (610 g/m²) copper clad.
7. Soldered (including exposed pad for K package) to typical application PCB with a heat sinking area of 1 sq. in. (645 mm²), 2 oz. (610 g/m²) copper clad.

Parameter	Symbol	Conditions		Min	Typ	Max	Units
		SOURCE = 0 V; T _J = 0 to 100 °C (Unless Otherwise Specified)					
Control Functions							
Programmable Maximum Frequency	f _{OSC}	T _J = 25 °C t _{ON} × I _{FB} = 1.4 mA-μs See Note A	V _{FB} = V _{FBth}			85	kHz
Minimum Operation Frequency	f _{OSC(MIN)}	T _J = 25 °C V _{FB} = V _{FBth}	LYT2001-2003	300	330	365	Hz
			LYT2004D/E/K	775	850	930	
			LYT2005	510	580	645	
Frequency Ratio (Constant Current)	f _{RATIO(CC)}	T _J = 25 °C Between V _{FB} = 1.0 V and V _{FB} = 1.6 V		1.550	1.593	1.635	
Frequency Ratio (Inductance Correction)	f _{RATIO(IC)}	Between t _{ON} × I _{FB} = 1.4 mA and t _{ON} × I _{FB} = 2 mA-μs		1.160	1.210	1.260	
Frequency Jitter		Peak-to-Peak Jitter Compared to Average Frequency, T _J = 25 °C			±7		%

Parameter	Symbol	Conditions		Min	Typ	Max	Units
		SOURCE = 0 V; T _J = 0 to 100 °C (Unless Otherwise Specified)					
Control Functions (cont.)							
Maximum Duty Cycle	DC _{MAX}	See Notes D, E			55		%
FEEDBACK Pin Voltage	V _{FB(TH)}	C _{BP} = 1 μF	T _J = 25 °C	1.915	1.940	1.965	V
			T _J = 100 °C See Note E	1.90	1.94	1.98	
FEEDBACK Pin Voltage at Turn-Off Threshold	V _{FB(AR)}			0.69	0.75	0.81	V
Minimum Switch ON-Time	t _{ON(MIN)}	See Note E			700		ns
FEEDBACK Pin Sampling Delay	t _{FB}	T _J = 25 °C		2.35	2.55	2.75	μs
DRAIN Pin Supply Current	I _{S1}	FB Voltage > V _{FBth} (MOSFET Not Switching)			320	370	μA
	I _{S2}	FB Voltage = V _{FBth} -0.1 V, Switch ON-Time = t _{ON} (MOSFET Switching at f _{OSC})	LYT2001		440		μA
			LYT2002		500	560	
			LYT2003		550	600	
			LYT2004		600	680	
		LYT2005		700	800		
BYPASS Pin Charge Current	I _{CH1}	V _{BP} = 0 V	LYT2001		-3.4		mA
			LYT2002	-7.0	-4.8	-2.5	
			LYT2003	-7.2	-5.8	-3.2	
			LYT2004	-8.5	-6.3	-3.2	
			LYT2005	-8.5	-6.3	-3.2	
	I _{CH2}	V _{BP} = 4 V	LYT2001		-2.3		
			LYT2002	-5.6	-3.2	-1.4	
			LYT2003	-5.6	-4.0	-2.0	
			LYT2004	-6.0	-4.4	-2.0	
			LYT2005	-6.0	-4.4	-2.0	
BYPASS Pin Voltage	V _{BP}			5.65	5.9	6.25	V
BYPASS Pin Voltage Hysteresis	V _{BPH}			0.70	0.95	1.20	V
BYPASS Pin Shunt Voltage	V _{SHUNT}			6.2	6.4	6.8	V

Parameter	Symbol	Conditions SOURCE = 0 V; $T_J = 0$ to $100\text{ }^\circ\text{C}$ (Unless Otherwise Specified)	Min	Typ	Max	Units
Circuit Protection						
Current Limit	I_{LIMIT}	$V_{BP} = 5.9\text{ V}$ $T_J = 25\text{ }^\circ\text{C}$	LYT2001D $di/dt = 60\text{ mA}/\mu\text{s}$		250	
			LYT2002D $di/dt = 80\text{ mA}/\mu\text{s}$	293	315	337
			LYT2003D $di/dt = 100\text{ mA}/\mu\text{s}$	363	390	417
			LYT2004D $di/dt = 105\text{ mA}/\mu\text{s}$	390	420	450
			LYT2004E/K $di/dt = 125\text{ mA}/\mu\text{s}$	460	495	530
			LYT2005E/K $di/dt = 135\text{ mA}/\mu\text{s}$	511	550	589
Minimum Current Limit Scale Factor	$I_{LIMIT(MIN)}$	$T_J = 25\text{ }^\circ\text{C}$	0.28	0.32	0.39	
Normalized Output Current	I_O	$T_J = 25\text{ }^\circ\text{C}$	0.975	1.000	1.025	
Leading Edge Blanking Time	t_{LED}	$T_J = 25\text{ }^\circ\text{C}$ See Note E	170	215		ns
Thermal Shutdown Temperature	T_{SD}	See Note E	135	142	150	$^\circ\text{C}$
Thermal Shutdown Hysteresis	T_{SDH}	See Note E		60		$^\circ\text{C}$
Output						
ON-State Resistance	$R_{DS(ON)}$	LYT2001D $I_D = 50\text{ mA}$	$T_J = 25\text{ }^\circ\text{C}$		24	
			$T_J = 100\text{ }^\circ\text{C}$		36	
		LYT2002D $I_D = 63\text{ mA}$	$T_J = 25\text{ }^\circ\text{C}$		13	15.5
			$T_J = 100\text{ }^\circ\text{C}$		20	23.5
		LYT2003D $I_D = 78\text{ mA}$	$T_J = 25\text{ }^\circ\text{C}$		8	9.2
			$T_J = 100\text{ }^\circ\text{C}$		12	14
		LYT2004D $I_D = 84\text{ mA}$	$T_J = 25\text{ }^\circ\text{C}$		5	5.9
			$T_J = 100\text{ }^\circ\text{C}$		7.5	8.60
		LYT2004E/K $I_D = 99\text{ mA}$	$T_J = 25\text{ }^\circ\text{C}$		5	5.9
			$T_J = 100\text{ }^\circ\text{C}$		7.5	8.60
		LYT2005E/K $I_D = 110\text{ mA}$	$T_J = 25\text{ }^\circ\text{C}$		3.2	3.8
			$T_J = 100\text{ }^\circ\text{C}$		4.6	5.40

Parameter	Symbol	Conditions SOURCE = 0 V; $T_J = 0$ to $100\text{ }^\circ\text{C}$ (Unless Otherwise Specified)	Min	Typ	Max	Units
Output (cont.)						
OFF-State Leakage	I_{DSS1}	$V_{DS} = 560\text{ V}$ $T_J = 125\text{ }^\circ\text{C}$, See Note C			50	μA
	I_{DSS2}	$V_{DS} = 375\text{ V}$ $T_J = 50\text{ }^\circ\text{C}$		15		
Breakdown Voltage	BV_{DSS}	$T_J = 25\text{ }^\circ\text{C}$	725			V
DRAIN Pin Supply Voltage			50			V
Auto-Restart ON-Time	t_{AR-ON}	$t_{ON} \times I_{FB} = 1.4\text{ mA}\mu\text{s}$ $f_{OSC} = 12\text{ kHz}$ $V_{FB} = 0$ See Notes A, E	100			ms
Auto-Restart OFF-Time	t_{AR-OFF}	See Note E	0.32			s
Open-Loop FEEDBACK Pin Current Threshold	I_{OL}	See Note E		-45		μA
Open-Loop ON-Time		See Note E		1.4		ms

NOTES:

- A. Auto-restart on-time is a function of switching frequency programmed by $t_{on} \times I_{FB}$ and minimum frequency in CC mode.
- B. The current limit threshold is compensated to cancel the effect of current limit delay. As a result the output current stays constant across the input line range.
- C. I_{DSS1} is the worst-case off-state leakage specification at 80% of BV_{DSS} and maximum operating junction temperature. I_{DSS2} is a typical specification under worst-case application conditions (rectified 265 VAC) for no-load consumption calculations.
- D. When the duty cycle exceeds DC_{MAX} the LYTSwitch-2 operates in on-time extension mode.
- E. This parameter is derived from characterization.

Typical Performance Characteristics

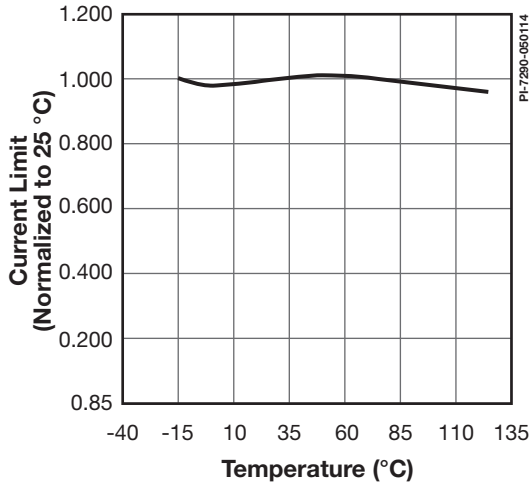

Figure 10. Current Limit vs. Temperature.

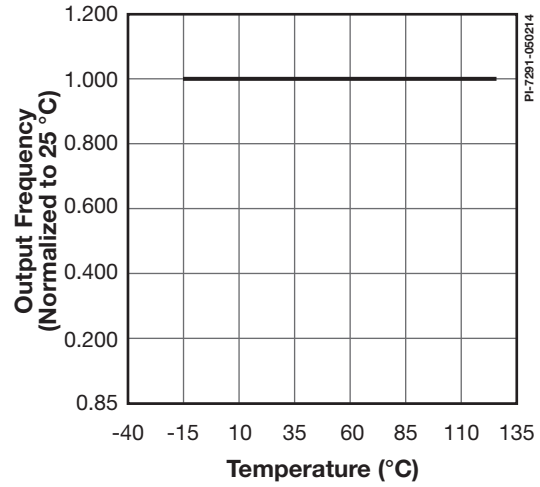

Figure 11. Output Frequency vs. Temperature.

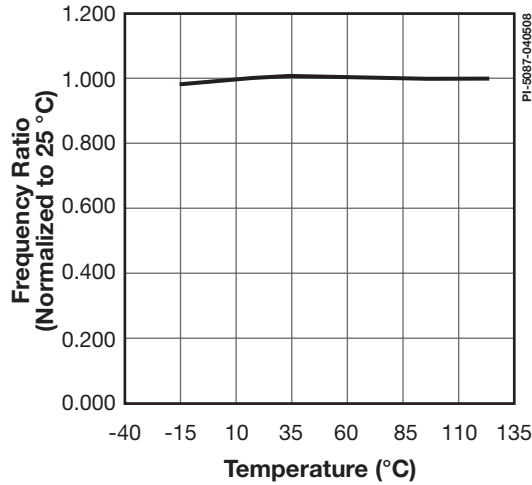

Figure 12. Frequency Ratio vs. Temperature (Constant Current).

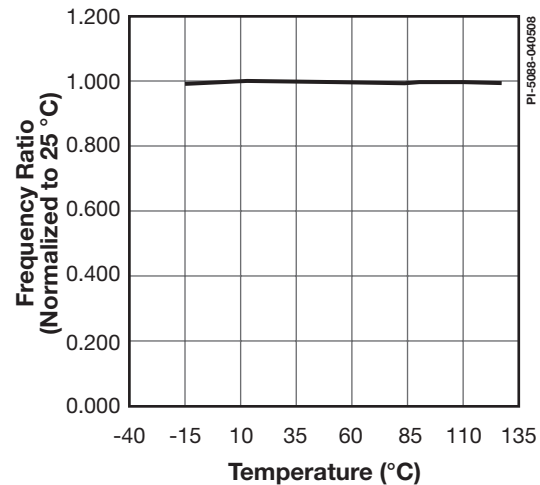

Figure 13. Frequency Ratio vs. Temperature (Inductor Current).

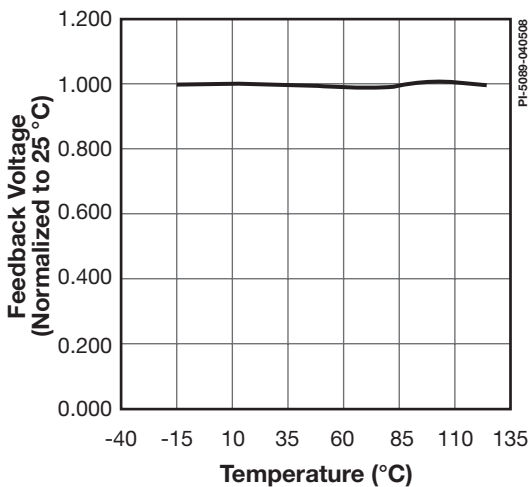

Figure 14. Feedback Voltage vs. Temperature.

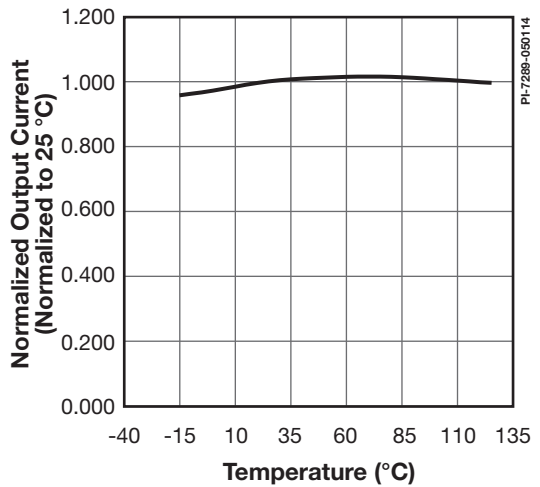

Figure 15. Normalized Output Current vs. Temperature.

Typical Performance Characteristics

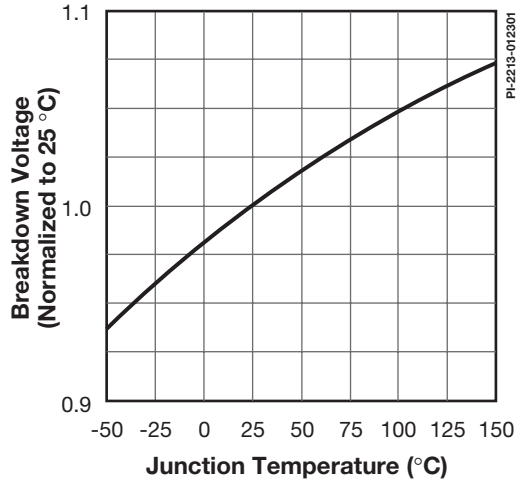

Figure 16. Breakdown vs. Temperature.

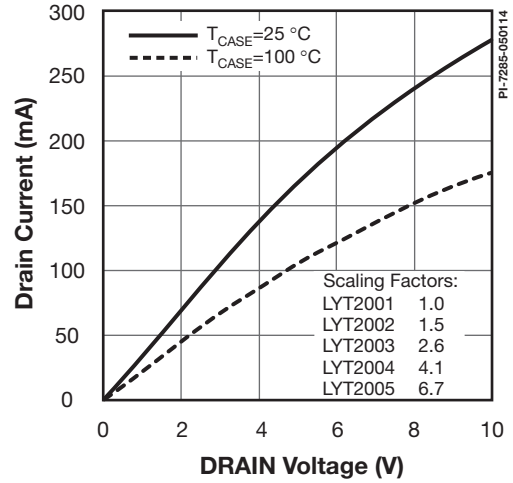

Figure 17. Output Characteristic.

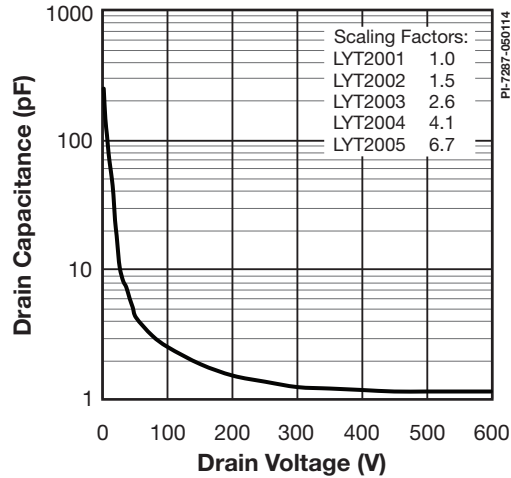

Figure 18. C_{oss} vs. Drain Voltage.

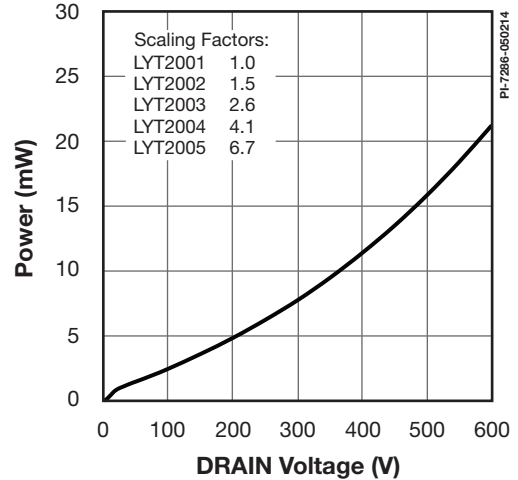
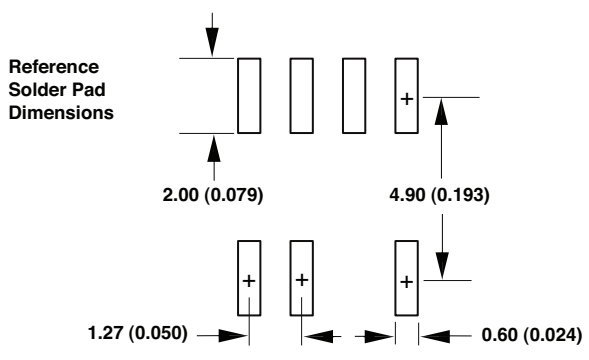
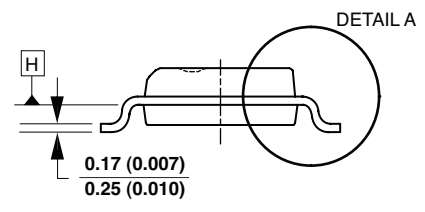
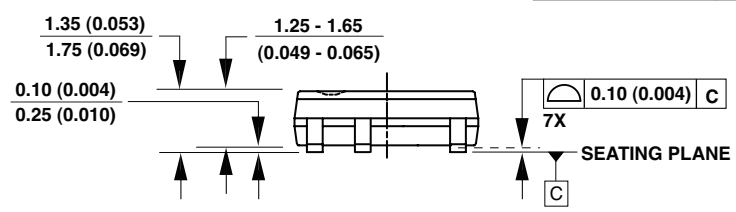
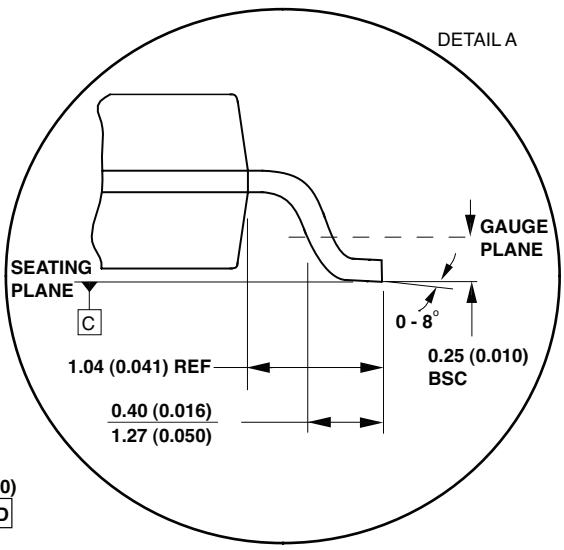
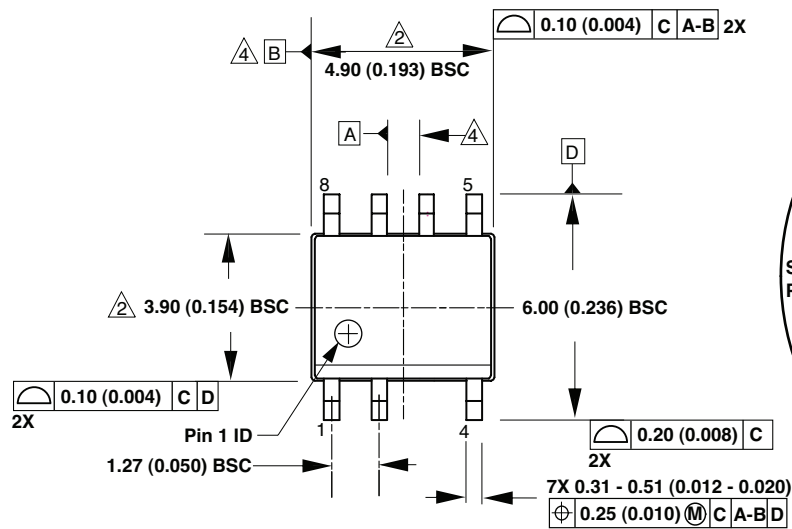

Figure 19. Drain Capacitance Power.

SO-8C (D Package)



- Notes:
1. JEDEC reference: MS-012.
 2. Package outline exclusive of mold flash and metal burr.
 3. Package outline inclusive of plating thickness.
 4. Datums A and B to be determined at datum plane H.
 5. Controlling dimensions are in millimeters. Inch dimensions are shown in parenthesis. Angles in degrees.

D07C

PI-4526-040110

eSIP-7C (E Package)

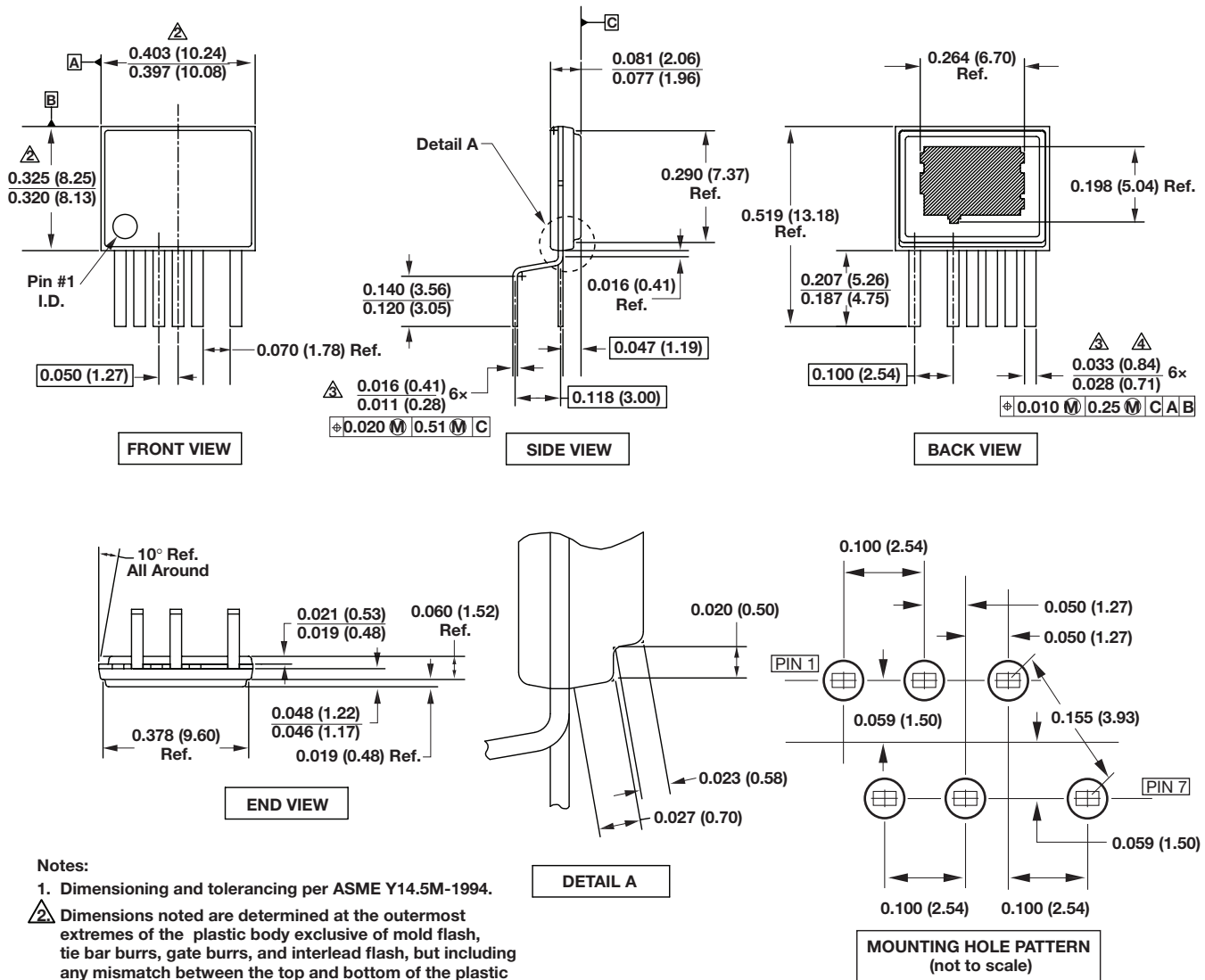

- Notes:
1. Dimensioning and tolerancing per ASME Y14.5M-1994.
 2. Dimensions noted are determined at the outermost extremes of the plastic body exclusive of mold flash, tie bar burrs, gate burrs, and interlead flash, but including any mismatch between the top and bottom of the plastic body. Maximum mold protrusion is 0.007 [0.18] per side.
 3. Dimensions noted are inclusive of plating thickness.
 4. Does not include inter-lead flash or protrusions.
 5. Controlling dimensions in inches (mm).

PI-4917-061510

eSOP-12B (K Package)

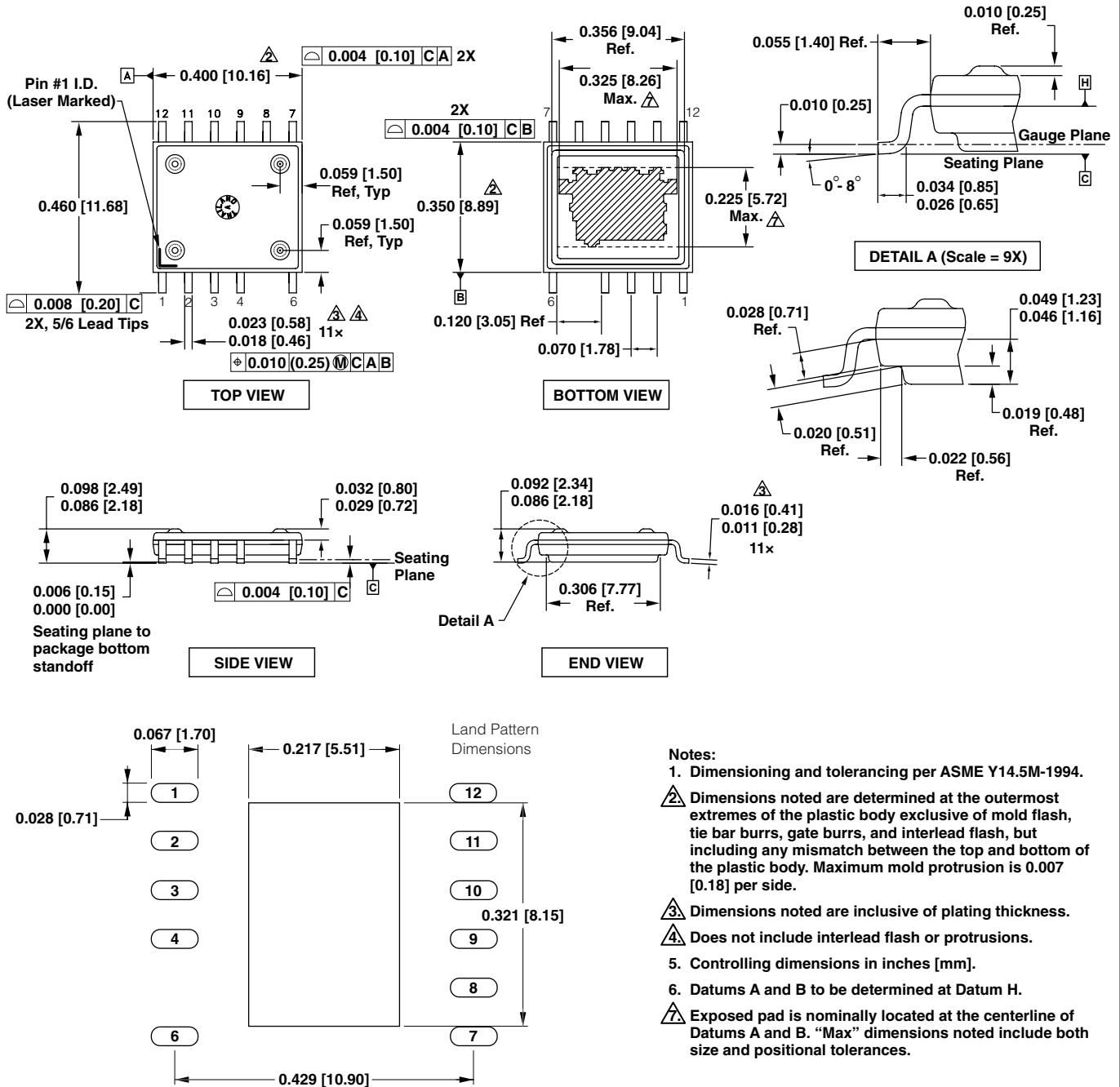

- Notes:**
1. Dimensioning and tolerancing per ASME Y14.5M-1994.
 2. Dimensions noted are determined at the outermost extremes of the plastic body exclusive of mold flash, tie bar burrs, gate burrs, and interlead flash, but including any mismatch between the top and bottom of the plastic body. Maximum mold protrusion is 0.007 [0.18] per side.
 3. Dimensions noted are inclusive of plating thickness.
 4. Does not include interlead flash or protrusions.
 5. Controlling dimensions in inches [mm].
 6. Datums A and B to be determined at Datum H.
 7. Exposed pad is nominally located at the centerline of Datums A and B. "Max" dimensions noted include both size and positional tolerances.

PI-5748a-100311

Part Ordering Information

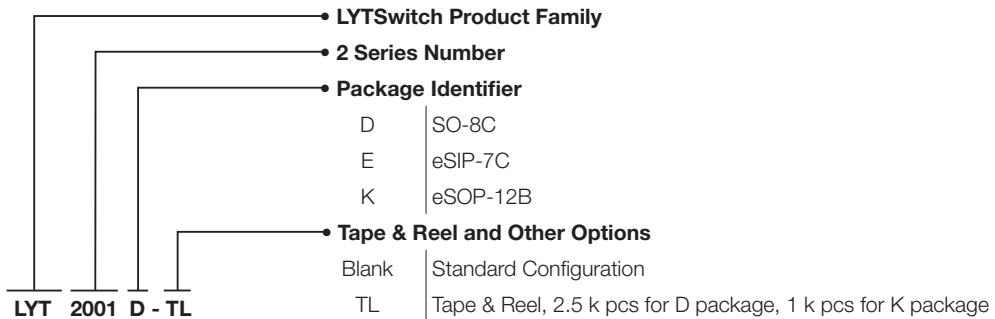

Revision	Notes	Date
A	Code A.	05/19/14
A	Updated Figure 2.	06/12/14
A	Updated $V_{FB(TH)}$ parameter table information.	12/08/14

For the latest updates, visit our website: www.power.com

Power Integrations reserves the right to make changes to its products at any time to improve reliability or manufacturability. Power Integrations does not assume any liability arising from the use of any device or circuit described herein. POWER INTEGRATIONS MAKES NO WARRANTY HEREIN AND SPECIFICALLY DISCLAIMS ALL WARRANTIES INCLUDING, WITHOUT LIMITATION, THE IMPLIED WARRANTIES OF MERCHANTABILITY, FITNESS FOR A PARTICULAR PURPOSE, AND NON-INFRINGEMENT OF THIRD PARTY RIGHTS.

Patent Information

The products and applications illustrated herein (including transformer construction and circuits external to the products) may be covered by one or more U.S. and foreign patents, or potentially by pending U.S. and foreign patent applications assigned to Power Integrations. A complete list of Power Integrations patents may be found at www.power.com. Power Integrations grants its customers a license under certain patent rights as set forth at <http://www.power.com/ip.htm>.

Life Support Policy

POWER INTEGRATIONS PRODUCTS ARE NOT AUTHORIZED FOR USE AS CRITICAL COMPONENTS IN LIFE SUPPORT DEVICES OR SYSTEMS WITHOUT THE EXPRESS WRITTEN APPROVAL OF THE PRESIDENT OF POWER INTEGRATIONS. As used herein:

1. A Life support device or system is one which, (i) is intended for surgical implant into the body, or (ii) supports or sustains life, and (iii) whose failure to perform, when properly used in accordance with instructions for use, can be reasonably expected to result in significant injury or death to the user.
2. A critical component is any component of a life support device or system whose failure to perform can be reasonably expected to cause the failure of the life support device or system, or to affect its safety or effectiveness.

The PI logo, TOPSwitch, TinySwitch, LinkSwitch, LYTSwitch, InnoSwitch, DPA-Switch, PeakSwitch, CAPZero, SENZero, LinkZero, HiperPFS, HiperTFS, HiperLCS, Qspeed, EcoSmart, Clampless, E-Shield, Filterfuse, FluxLink, StakFET, PI Expert and PI FACTS are trademarks of Power Integrations, Inc. Other trademarks are property of their respective companies. ©2014, Power Integrations, Inc.

Power Integrations Worldwide Sales Support Locations

World Headquarters

5245 Hellyer Avenue
San Jose, CA 95138, USA.
Main: +1-408-414-9200
Customer Service:
Phone: +1-408-414-9665
Fax: +1-408-414-9765
e-mail: usasales@powerint.com

China (Shanghai)

Rm 2410, Charity Plaza, No. 88
North Caoxi Road
Shanghai, PRC 200030
Phone: +86-21-6354-6323
Fax: +86-21-6354-6325
e-mail: chinasales@powerint.com

China (Shenzhen)

17/F, Hivac Building, No. 2, Keji
Nan 8th Road, Nanshan District,
Shenzhen, China, 518057
Phone: +86-755-8672-8689
Fax: +86-755-8672-8690
e-mail: chinasales@powerint.com

Germany

Lindwurmstrasse 114
80337 Munich
Germany
Phone: +49-895-527-39110
Fax: +49-895-527-39200
e-mail: eurosales@powerint.com

India

#1, 14th Main Road
Vasanthanagar
Bangalore-560052 India
Phone: +91-80-4113-8020
Fax: +91-80-4113-8023
e-mail: indiasales@powerint.com

Italy

Via Milanese 20, 3rd. Fl.
20099 Sesto San Giovanni (MI)
Italy
Phone: +39-024-550-8701
Fax: +39-028-928-6009
e-mail: eurosales@powerint.com

Japan

Kosei Dai-3 Bldg.
2-12-11, Shin-Yokohama,
Kohoku-ku
Yokohama-shi Kanagawan
222-0033 Japan
Phone: +81-45-471-1021
Fax: +81-45-471-3717
e-mail: japansales@powerint.com

Korea

RM 602, 6FL
Korea City Air Terminal B/D, 159-6
Samsung-Dong, Kangnam-Gu,
Seoul, 135-728, Korea
Phone: +82-2-2016-6610
Fax: +82-2-2016-6630
e-mail: koreasales@powerint.com

Singapore

51 Newton Road
#19-01/05 Goldhill Plaza
Singapore, 308900
Phone: +65-6358-2160
Fax: +65-6358-2015
e-mail: singaporesales@powerint.com

Taiwan

5F, No. 318, Nei Hu Rd., Sec. 1
Nei Hu Dist.
Taipei 11493, Taiwan R.O.C.
Phone: +886-2-2659-4570
Fax: +886-2-2659-4550
e-mail: taiwansales@powerint.com

UK

First Floor, Unit 15, Meadway
Court, Rutherford Close,
Stevenage, Herts. SG1 2EF
United Kingdom
Phone: +44 (0) 1252-730-141
Fax: +44 (0) 1252-727-689
e-mail: eurosales@powerint.com

Applications Hotline

World Wide +1-408-414-9660

Applications Fax

World Wide +1-408-414-9760

Компания «Океан Электроники» предлагает заключение долгосрочных отношений при поставках импортных электронных компонентов на взаимовыгодных условиях!

Наши преимущества:

- Поставка оригинальных импортных электронных компонентов напрямую с производств Америки, Европы и Азии, а так же с крупнейших складов мира;
- Широкая линейка поставок активных и пассивных импортных электронных компонентов (более 30 млн. наименований);
- Поставка сложных, дефицитных, либо снятых с производства позиций;
- Оперативные сроки поставки под заказ (от 5 рабочих дней);
- Экспресс доставка в любую точку России;
- Помощь Конструкторского Отдела и консультации квалифицированных инженеров;
- Техническая поддержка проекта, помощь в подборе аналогов, поставка прототипов;
- Поставка электронных компонентов под контролем ВП;
- Система менеджмента качества сертифицирована по Международному стандарту ISO 9001;
- При необходимости вся продукция военного и аэрокосмического назначения проходит испытания и сертификацию в лаборатории (по согласованию с заказчиком);
- Поставка специализированных компонентов военного и аэрокосмического уровня качества (Xilinx, Altera, Analog Devices, Intersil, Interpoint, Microsemi, Actel, Aeroflex, Peregrine, VPT, Syfer, Eurofarad, Texas Instruments, MS Kennedy, Miteq, Cobham, E2V, MA-COM, Hittite, Mini-Circuits, General Dynamics и др.);

Компания «Океан Электроники» является официальным дистрибьютором и эксклюзивным представителем в России одного из крупнейших производителей разъемов военного и аэрокосмического назначения «**JONHON**», а так же официальным дистрибьютором и эксклюзивным представителем в России производителя высокотехнологичных и надежных решений для передачи СВЧ сигналов «**FORSTAR**».



JONHON

«**JONHON**» (основан в 1970 г.)

Разъемы специального, военного и аэрокосмического назначения:

(Применяются в военной, авиационной, аэрокосмической, морской, железнодорожной, горно- и нефтедобывающей отраслях промышленности)

«**FORSTAR**» (основан в 1998 г.)

ВЧ соединители, коаксиальные кабели, кабельные сборки и микроволновые компоненты:

(Применяются в телекоммуникациях гражданского и специального назначения, в средствах связи, РЛС, а так же военной, авиационной и аэрокосмической отраслях промышленности).



Телефон: 8 (812) 309-75-97 (многоканальный)

Факс: 8 (812) 320-03-32

Электронная почта: ocean@oceanchips.ru

Web: <http://oceanchips.ru/>

Адрес: 198099, г. Санкт-Петербург, ул. Калинина, д. 2, корп. 4, лит. А