

Long-distance Proximity Sensor

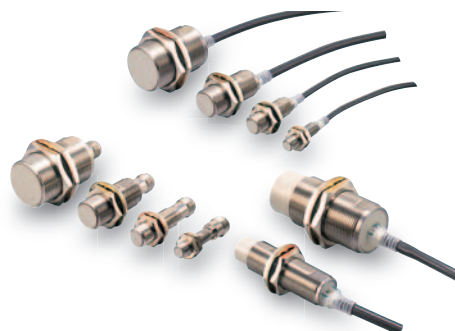

- Long-distance detection at up to 30 mm enables secure mounting with reduced problems due to workpiece collisions.
- No polarity for easy wiring with DC 2-wire models.
- Cable protector provided as a standard feature.



For the most recent information on models that have been certified for safety standards, refer to your OMRON website.





Be sure to read *Safety Precautions* on page 6.

Ordering Information

Sensors [Refer to *Dimensions* on page 7.]

DC 2-Wire, Pre-wired Models

| Appearance | Sensing distance | Model | | |
|--|------------------|-------|------------------|----------------|
| | | NO | NC | |
| Shielded  *1 | M12 | 4 mm | E2EM-X4X1 2M *2 | E2EM-X4X2 2M |
| | M18 | 8 mm | E2EM-X8X1 2M *2 | E2EM-X8X2 2M |
| | M30 | 15 mm | E2EM-X15X1 2M *2 | E2EM-X15X2 2M |
| Unshielded  | M18 | 16 mm | E2EM-X16MX1 2M | E2EM-X16MX2 2M |
| | M30 | 30 mm | E2EM-X30MX1 2M | E2EM-X30MX2 2M |

*1. There are installation restrictions that apply to Shielded Sensors. Refer to Reference *Influence of Surrounding Metal* in *Safety Precautions* on page 6.

*2. Pre-wired M12 Connector Models with a cable length of 300 mm are also available. Add -M1J to the end of the model number (example: E2EM-X4X1-M1J).

DC 3-Wire, Pre-wired Models

| Appearance | Sensing distance | Model | | |
|---|------------------|------------------------------|------------------------------|---------------|
| | | Output configuration: NPN NO | Output configuration: NPN NC | |
| Shielded  * | M8 | 2 mm | E2EM-X2C1 2M | E2EM-X2C2 2M |
| | M12 | 4 mm | E2EM-X4C1 2M | E2EM-X4C2 2M |
| | M18 | 8 mm | E2EM-X8C1 2M | E2EM-X8C2 2M |
| | M30 | 15 mm | E2EM-X15C1 2M | E2EM-X15C2 2M |

* There are installation restrictions that apply to Shielded Sensors. Refer to Reference *Influence of Surrounding Metal* in *Safety Precautions* on page 6.

DC 3-Wire, M12 Connector Models



| Appearance | Sensing distance | Model | | |
|---|------------------|------------------------------|------------------------------|---------------|
| | | Output configuration: NPN NO | Output configuration: NPN NC | |
| Shielded  * | M8 | 2 mm | E2EM-X2C1-M1 | E2EM-X2C2-M1 |
| | M12 | 4 mm | E2EM-X4C1-M1 | E2EM-X4C2-M1 |
| | M18 | 8 mm | E2EM-X8C1-M1 | E2EM-X8C2-M1 |
| | M30 | 15 mm | E2EM-X15C1-M1 | E2EM-X15C2-M1 |

* There are installation restrictions that apply to Shielded Sensors. Refer to Reference *Influence of Surrounding Metal* in *Safety Precautions* on page 6.

Accessories (Order Separately)

Sensor I/O Connectors (M12, Sockets on One Cable End)

(Models for Connectors and with Pre-wired Connectors: A Connector is not provided with the Sensor. Be sure to order a Connector separately.) [Refer to XS2.]

| Appearance | Cable length | Sensor I/O Connector model number | Applicable Proximity Sensor model number |
|--|--------------|-----------------------------------|--|
|  Straight | 2 m | XS2F-D421-DC0-F | E2EM-X□C1-M1 |
| | 5 m | XS2F-D421-GC0-F | |
| | 2 m | XS2F-D421-D80-F | E2EM-X□C□-M1 |
| | 5 m | XS2F-D421-G80-F | |
|  L-shape | 2 m | XS2F-D422-DC0-F | E2EM-X□C1-M1 |
| | 5 m | XS2F-D422-GC0-F | |
| | 2 m | XS2F-D422-D80-F | E2EM-X□C□-M1 |
| | 5 m | XS2F-D422-G80-F | |

Note: Refer to *Introduction to Sensor I/O Connectors/Sensor Controllers* for details.

Use the XS2F-D42□-□CO-A for the E2EM-X□X1-M1J. (Terminal 3: 0 V (+V), Terminal 4: +V (0 V))

Ratings and Specifications

E2EM-X□X□ DC 2-Wire Models

| Item | Size Shielded Model | M12 | | M18 | | M30 | |
|---|----------------------------|--|----------------------|----------------------|----------------------|----------------------|------------|
| | | Shielded | Shielded | Shielded | Unshielded | Shielded | Unshielded |
| | | E2EM-X4X□ | E2EM-X8X□ | E2EM-X16MX□ | E2EM-X15X□ | E2EM-X30MX□ | |
| Sensing distance | | 4 mm ±10% | 8 mm ±10% | 16 mm ±10% | 15 mm ±10% | 30 mm ±10% | |
| Set distance *1 | | 0 to 3.2 mm | 0 to 6.4 mm | 0 to 12.8 mm | 0 to 12 mm | 0 to 24 mm | |
| Differential travel | | 15% max. of sensing distance | | | | | |
| Detectable object | | Ferrous metal (The sensing distance decreases with non-ferrous metal. Refer to <i>Engineering Data</i> on page 4.) | | | | | |
| Standard sensing object | | Iron, 12 × 12 × 1 mm | Iron, 18 × 18 × 1 mm | Iron, 45 × 45 × 1 mm | Iron, 30 × 30 × 1 mm | Iron, 70 × 70 × 1 mm | |
| Response frequency *2 | | 1 kHz | 0.5 kHz | 0.4 kHz | 0.25 kHz | 0.1 kHz | |
| Power supply voltage (operating voltage range) | | 12 to 24 VDC (10 to 30 VDC), ripple (p-p): 10% max. | | | | | |
| Leakage current | | 0.8 mA max. | | | | | |
| Control output | Load current | 3 to 100 mA | | | | | |
| | Residual voltage *3 | 5 V max. (Load current: 100 mA, Cable length: 2 m) | | | | | |
| Indicators | | X1 Models: Operation indicator (red), Setting indicator (green) X2 Models: Operation indicator (red) | | | | | |
| Operation mode (with sensing object approaching) | | X1 Models: NO Refer to the timing charts under <i>I/O Circuit Diagrams</i> on page 5 for details. X2 Models: NC | | | | | |
| Protection circuits | | Surge suppressor, Load short-circuit protection | | | | | |
| Ambient temperature range | | Operating: -25 to 70°C, Storage: -40 to 85°C (with no icing or condensation) | | | | | |
| Ambient humidity range | | Operating/Storage: 35% to 95% (with no condensation) | | | | | |
| Temperature influence | | ±15% max. of sensing distance at 23°C in the temperature range of -25 to 70°C | | | | | |
| Voltage influence | | ±1% max. of sensing distance at rated voltage in the rated voltage ±15% range | | | | | |
| Insulation resistance | | 50 MΩ min. (at 500 VDC) between current-carrying parts and case | | | | | |
| Dielectric strength | | 1,000 VAC, 50/60 Hz for 1 minute between current-carrying parts and case | | | | | |
| Vibration resistance | | Destruction: 10 to 55 Hz, 1.5-mm double amplitude for 2 hours each in X, Y, and Z directions | | | | | |
| Shock resistance | | Destruction: 1,000 m/s ² 10 times each in X, Y, and Z directions | | | | | |
| Degree of protection | | IEC 60529 IP67, in-house standards: oil-resistant | | | | | |
| Connection method | | Pre-wired Models (Standard cable length: 2 m) | | | | | |
| Weight (packed state) | | Approx. 60 g | Approx. 130 g | Approx. 150 g | Approx. 180 g | Approx. 210 g | |
| Materials | Case | Nickel-plated brass | | | | | |
| | Sensing surface | PBT | | | | | |
| | Clamping nuts | Nickel-plated brass | | | | | |
| | Toothed washer | Zinc-plated iron | | | | | |
| Accessories | | Instruction manual | | | | | |

*1. Use the Sensor within the range in which the setting indicator (green LED) is ON (except X2 Models).

*2. The response frequency is an average value.

Measurement conditions are as follows: standard sensing object, a distance of twice the standard sensing object, and a set distance of half the sensing distance.

*3. The residual voltage is 5 V. Make sure that the device connected to the Sensor can withstand the residual voltage. (Refer to page 6 for details.)

E2EM-X□C□ DC 3-Wire Models

| Item | Size Shielded Model | M8 | M12 | M18 | M30 |
|---|---------------------------|--|---|----------------------|--|
| | | Shielded | Shielded | Shielded | Shielded |
| | | E2EM-X2C□(-M1) | E2EM-X4C□(-M1) | E2EM-X8C□(-M1) | E2EM-X15C□(-M1) |
| Sensing distance | | 2 mm ±10% | 4 mm ±10% | 8 mm ±10% | 15 mm ±10% |
| Set distance | | 0 to 1.6 mm | 0 to 3.2 mm | 0 to 6.4 mm | 0 to 12 mm |
| Differential travel | | 10% max. of sensing distance | | | |
| Detectable object | | Ferrous metal (The sensing distance decreases with non-ferrous metal. Refer to <i>Engineering Data</i> on page 4.) | | | |
| Standard sensing object | | Iron, 8 × 8 × 1 mm | Iron, 12 × 12 × 1 mm | Iron, 18 × 18 × 1 mm | Iron, 30 × 30 × 1 mm |
| Response frequency *1 | | 1.5 kHz | 0.5 kHz | 0.3 kHz | 0.1 kHz |
| Power supply voltage (operating voltage range) *2 | | 12 to 24 VDC (10 to 40 VDC), ripple (p-p): 10% max. | | | |
| Current consumption | | 13 mA max. | | | |
| Control output | Load current *2 | 200 mA max. | | | |
| | Residual voltage | 2 V max. (Load current: 200 mA, Cable length: 2 m) | | | |
| Indicators | | Operation indicator (yellow) | | | |
| Operation mode (with sens- ing object approaching) | | C1 Models: NO C2 Models: NC Refer to the timing charts under <i>I/O Circuit Diagrams</i> on page 5 for details. | | | |
| Protection circuits | | Reverse polarity protection, Load short-circuit protection, Surge suppressor | | | |
| Ambient temperature range *1 | | Operating/Storage: -40 to 85°C (with no icing or condensation) | | | Operating: -25 to 70°C Storage: -40 to 85°C (with no icing or condensation) |
| Ambient humidity range | | Operating/Storage: 35% to 95% (with no condensation) | | | |
| Temperature influence | | ±15% max. of sensing distance at 23°C in the temperature range of -40 to 85°C ±10% max. of sensing distance at 23°C in the temperature range of -25 to 70°C | | | ±15% max. of sensing dis- tance at 23°C in the tem- perature range of -25 to 70°C |
| Voltage influence | | ±1% max. of sensing distance at rated voltage in the rated voltage ±15% range | | | |
| Insulation resistance | | 50 MΩ min. (at 500 VDC) between current-carrying parts and case | | | |
| Dielectric strength | | 1,000 VAC, 50/60 Hz for 1 minute between current-carrying parts and case | | | |
| Vibration resistance | | Destruction: 10 to 55 Hz, 1.5-mm double amplitude for 2 hours each in X, Y, and Z directions | | | |
| Shock resistance | | Destruction: 500 m/s ² 10 times each in X, Y, and Z directions | Destruction: 1,000 m/s ² 10 times each in X, Y, and Z directions | | |
| Degree of protection | | Pre-wired Models: IEC 60529 IP67, in-house standards: oil-resistant Connector Models: IEC 60529 IP67 | | | |
| Connection method | | Pre-wired Models (Standard cable length: 2 m) Connector Models | | | |
| Weight (packed state) | Pre-wired Models | Approx. 65 g | Approx. 75 g | Approx. 150 g | Approx. 195 g |
| | Connector Mod- els | Approx. 15 g | Approx. 25 g | Approx. 40 g | Approx. 90 g |
| Materials | Case | Stainless steel (SUS303) | Nickel-plated brass | | |
| | Sensing surface | PBT | | | |
| | Clamping nuts | Nickel-plated brass | | | |
| | Toothed washer | Zinc-plated iron | | | |
| Accessories | | Instruction manual | | | |

*1. The response frequency is an average value.

Measurement conditions are as follows: standard sensing object, a distance of twice the standard sensing object, and a set distance of half the sensing distance.

*2. When using an M8 Model at an ambient temperature between 70 and 85°C, supply 10 to 30 VDC to the Sensor and make sure that the Sensor has a control output of 100 mA maximum.

Engineering Data (Reference Value)

Sensing Area

Unshielded Models

E2EM-X□MX□

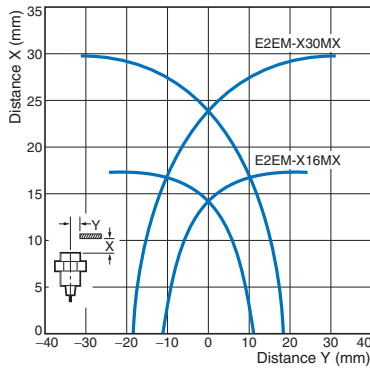

Shielded Models

E2EM-X□X□

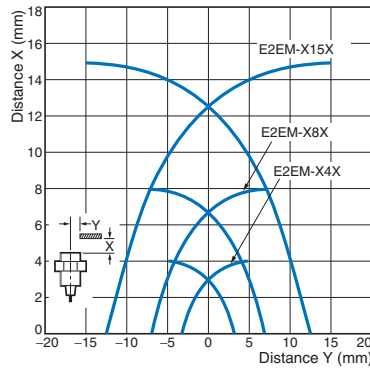

E2EM-X□C□

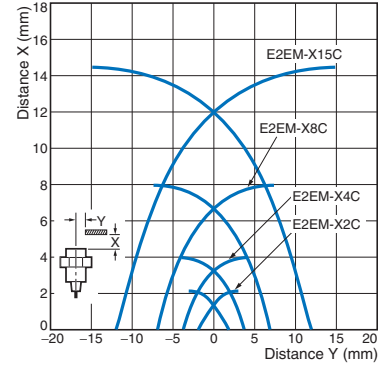

Influence of Sensing Object Size and Material

E2EM-X2□□(-M1)

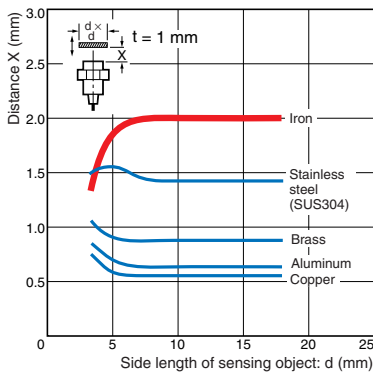

E2EM-X4□□(-M1)

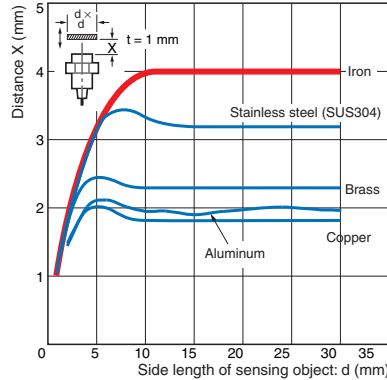

E2EM-X8□□(-M1)

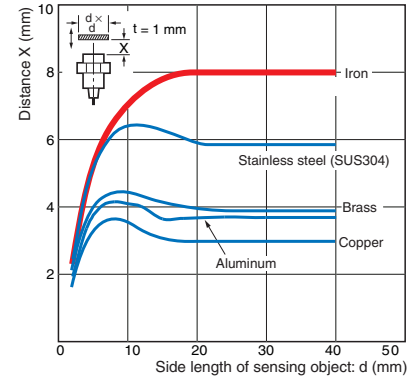

E2EM-X15□□(-M1)

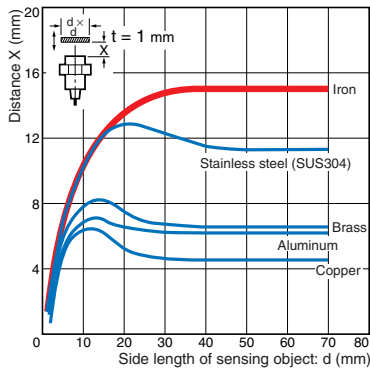

E2EM-X16MX□

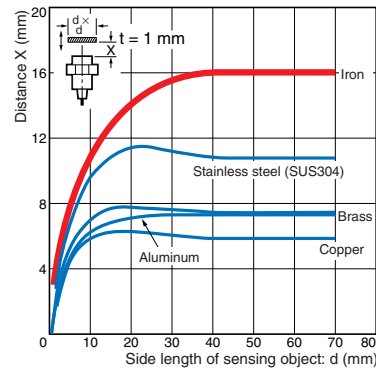

E2EM-X30MX□

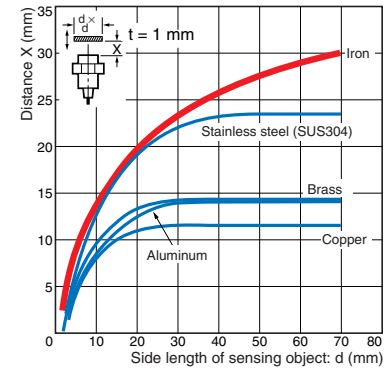

Residual Output Voltage

E2EM-X□X□

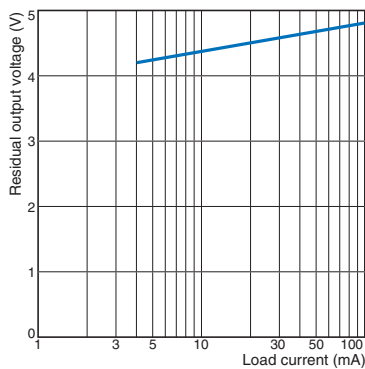

I/O Circuit Diagrams

E2EM-X□X□ DC 2-Wire Models

| Operation mode | Model | Timing chart | Output circuit |
|----------------|--|--------------|--|
| NO | E2EM-X4X1 E2EM-X8X1 E2EM-X15X1 E2EM-X16MX1 E2EM-X30MX1 | | |
| NC | E2EM-X4X2 E2EM-X8X2 E2EM-X15X2 E2EM-X16MX2 E2EM-X30MX2 | | <p>Note 1. The load can be connected to either the +V or 0 V side.</p> <p>Note 2. There is no polarity. Therefore, the brown and blue lines have no polarity.</p> <p>Note 3. Use pins 4 and 3 for NO. Use pins 1 and 2 for NC.</p> |

E2EM-X□C□(-M1) DC 3-Wire Models

| Operation mode | Output specifications | Model | Timing chart | Output circuit |
|----------------|------------------------------|---|--------------|--|
| NO | NPN Open-collector output | E2EM-X2C1 (-M1) E2EM-X4C□ 1-M1 E2EM-X8C1 (-M1) E2EM-X15C1 (-M1) | | <p>Note: Use pin 4 for NO. Use pin 2 for NC.</p> |
| NC | | E2EM-X2C2 (-M1) E2EM-X4C2 (-M1) E2EM-X8C2 (-M1) E2EM-X15C2 (-M1) | | |

Connections for Sensor I/O Connectors

| Type | Proximity Sensor | | Sensor I/O Connector model | Connections |
|-----------|------------------|---------------|--|-------------|
| | Operation mode | Model | | |
| DC 2-wire | NO | E2EM-X□X1-M1J | XS2F-D42□-□C0-F 1: Straight 2: L-shape D: 2-m cable G: 5-m cable | |
| | NC | E2EM-X□X2-M1J | XS2F-D42□-□80-F 1: Straight 2: L-shape D: 2-m cable G: 5-m cable | |
| DC 3-wire | NO | E2EM-X□C1-M1 | XS2F-D42□-□C0-F 1: Straight 2: L-shape D: 2-m cable G: 5-m cable | |
| | NC | E2EM-X□C2-M1 | XS2F-D42□-□80-F 1: Straight 2: L-shape D: 2-m cable G: 5-m cable | |

Refer to *Introduction to Sensor I/O Connectors/Sensor Controllers* for details.

Safety Precautions

Refer to *Warranty and Limitations of Liability*.

⚠ WARNING

This product is not designed or rated for ensuring safety of persons either directly or indirectly. Do not use it for such purposes.



Precautions for Correct Use

Do not use this product under ambient conditions that exceed the ratings.

● Design

Influence of Surrounding Metal

When mounting the Sensor within a metal panel, ensure that the clearances given in the following table are maintained. Failure to maintain these distances may cause deterioration in the performance of the Sensor.

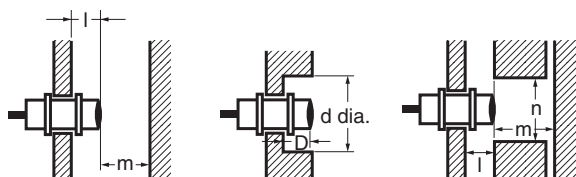

Influence of Surrounding Metal (Unit: mm)

| Type | Item | M8 | M12 | M18 | M30 | |
|------------------------|------------|----|-----|-----|-----|-----|
| DC 2-wire E2EM-X□X□ | Shielded | l | | 2.4 | 3.6 | 6 |
| | | d | | 18 | 27 | 45 |
| | | D | --- | 2.4 | 3.6 | 6 |
| | | m | | 12 | 24 | 45 |
| | | n | | 18 | 27 | 45 |
| | Unshielded | l | | | 25 | 45 |
| | | d | | | 70 | 120 |
| | | D | --- | --- | 25 | 45 |
| | | m | | | 48 | 90 |
| | | n | | | 70 | 120 |
| DC 3-wire E2EM-X□C□ | Shielded | l | 0 | 2.4 | 3.6 | 6 |
| | | d | 8 | 18 | 27 | 45 |
| | | D | 0 | 2.4 | 3.6 | 6 |
| | | m | 4.5 | 12 | 24 | 45 |
| | | n | 12 | 18 | 27 | 45 |
| | | | | | | |

AND/OR Connections

Error pulses and leakage current may prevent application in AND or OR circuits. Always confirm operation in advance to confirm if there are any problems in operation.

Mutual Interference

When installing Sensors face-to-face or side-by-side, ensure that the minimum distances given in the following table are maintained.

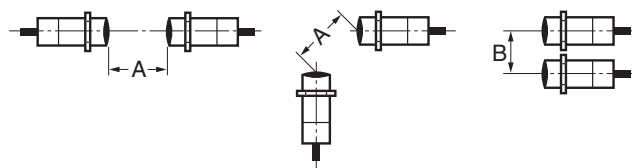

Mutual Interference (Unit: mm)

| Type | Item | M8 | M12 | M18 | M30 | |
|------------------------|------------|----|-----|-----|-----|-----|
| DC 2-wire E2EM-X□X□ | Shielded | A | | 30 | 60 | 110 |
| | | B | | 20 | 35 | 90 |
| | Unshielded | A | --- | | 200 | 350 |
| | | B | | | 120 | 300 |
| DC 3-wire E2EM-X□C□ | Shielded | A | 20 | 30 | 60 | 110 |
| | | B | 15 | 20 | 35 | 90 |

Connecting a DC 2-wire Proximity Sensor to a PLC (Programmable Controller)

Required Conditions

Connection to a PLC is possible if the specifications of the PLC and the Proximity Sensor satisfy the following conditions. (The meanings of the symbols are given below.)

- The ON voltage of the PLC and the residual voltage of the Proximity Sensor must satisfy the following.
 $V_{ON} \leq V_{CC} - V_R$
- The OFF current of the PLC and the leakage current of the Proximity Sensor must satisfy the following.
 $I_{OFF} \geq I_{leak}$
 (If the OFF current is not listed in the specifications, take it to be **1.3 mA**.)
- The ON current of the PLC and the control output (I_{OUT}) of the Proximity Sensor must satisfy the following.
 $I_{OUT}(\min.) \leq I_{ON} \leq I_{OUT}(\max.)$
 The ON current of the PLC will vary, however, with the power supply voltage and the input impedance, as shown in the following equation.
 $I_{ON} = (V_{CC} - V_R - V_{PC})/R_{IN}$

Example

In this example, the above conditions are checked when the PLC Unit is the C200H-ID212, the Proximity Sensor is the E2EM-X8X1, and the power supply voltage is 24 V.

- $V_{ON} (14.4 \text{ V}) \leq V_{CC} (20.4 \text{ V}) - V_R (5 \text{ V}) = 15.4 \text{ V}$: OK
- $I_{OFF} (1.3 \text{ mA}) \geq I_{leak} (0.8 \text{ mA})$: OK
- $I_{ON} = [V_{CC} (20.4 \text{ V}) - V_R (5 \text{ V}) - V_{PC} (4 \text{ V})]/R_{IN} (3 \text{ k}\Omega) = \text{Approx. } 3.8 \text{ mA}$
 Therefore, $I_{OUT}(\min.) (3 \text{ mA}) \leq I_{ON} (3.8 \text{ mA})$: OK

| | |
|--|---|
| V_{ON} : | ON voltage of PLC (14.4 V) |
| I_{ON} : | ON current of PLC (typ. 7 mA) |
| I_{OFF} : | OFF current of PLC (1.3 mA) |
| R_{IN} : | Input impedance of PLC (3 k Ω) |
| V_{PC} : | Internal residual voltage of PLC (4 V) |
| V_R : | Output residual voltage of Proximity Sensor (5 V) |
| I_{leak} : | Leakage current of Proximity Sensor (0.8 mA) |
| I_{OUT} : | Control output of Proximity Sensor (3 to 100 mA) |
| V_{CC} : | Power supply voltage (PLC: 20.4 to 26.4 V) |
| Values in parentheses apply to the following PLC model and Proximity Sensor model. | |
| PLC: C200H-ID212 | |
| Sensor: E2EM-X8X1 | |

● **Mounting**

Tightening Force

Do not tighten the nut with excessive force.
A washer must be used with the nut.

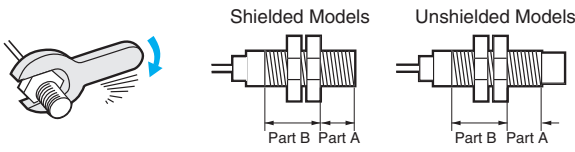

Note: 1. The allowable tightening strength depends on the distance from the edge of the head, as shown in the following table. (A is the distance from the edge of the head. B includes the nut on the head side. If the edge of the nut is in part A, the tightening torque for part A applies instead.)
2. The following strengths assume washers are being used.

| Torque | | Part A | | Part B |
|--------|----------|----------------|---------|--------|
| Model | | Dimension (mm) | Torque | Torque |
| M8 | Shielded | 9 | 9 N·m | 12 N·m |
| M12 | | | 30 N·m | |
| M18 | | | 70 N·m | |
| M30 | | | 180 N·m | |

Dimensions

(Unit: mm)
Tolerance class IT16 applies to dimensions in this data sheet unless otherwise specified.

Pre-wired Models (Shielded)

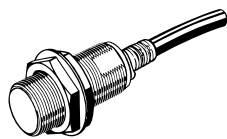

Mounting Hole Dimensions



| Dimensions | M8 | M12 | M18 | M30 |
|------------|---------------------------------------|--|--|--|
| F (mm) | 8.5 ^{+0.5} ₀ dia. | 12.5 ^{+0.5} ₀ dia. | 18.5 ^{+0.5} ₀ dia. | 30.5 ^{+0.5} ₀ dia. |

E2EM-X2C

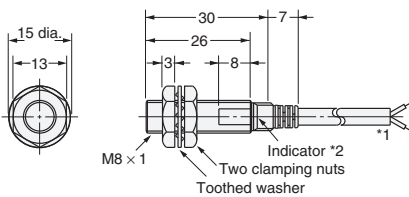

- 4-dia. vinyl-insulated round cable with 2/3 conductors (Conductor cross section: 0.3 mm², Insulator diameter: 1.3 mm), Standard length: 2 m
The cable can be extended up to 200 m (separate metal conduit).
- Operation indicator (yellow)

E2EM-X4

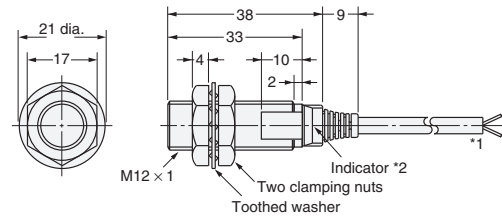

- 4-dia. vinyl-insulated round cable with 2/3 conductors (Conductor cross section: 0.3 mm², Insulator diameter: 1.3 mm), Standard length: 2 m
- X1 Models: Operation indicator (red)
Setting indicator (green)
X2 Models: Operation indicator (red)
C Models: Operation indicator (yellow)

E2EM-X8

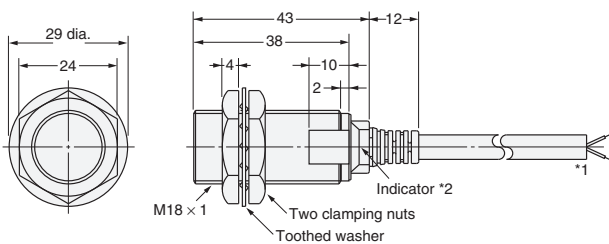

- 6-dia. vinyl-insulated round cable with 2/3 conductors (Conductor cross section: 0.5 mm², Insulator diameter: 1.9 mm), Standard length: 2 m
- X1 Models: Operation indicator (red) Setting indicator (green)
X2 Models: Operation indicator (red)
C Models: Operation indicator (yellow)

E2EM-X15

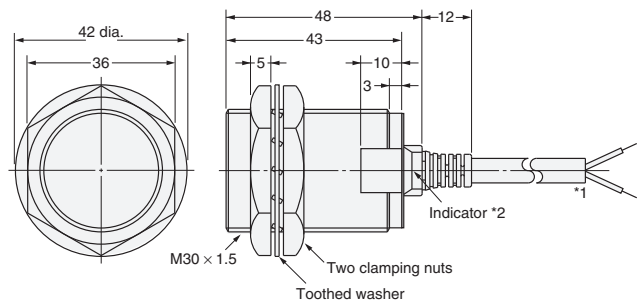

- 6-dia. vinyl-insulated round cable with 2/3 conductors (Conductor cross section: 0.5 mm², Insulator diameter: 1.9 mm), Standard length: 2 m
- X1 Models: Operation indicator (red) Setting indicator (green)
X2 Models: Operation indicator (red)
C Models: Operation indicator (yellow)

Pre-wired Models
(Unshielded)

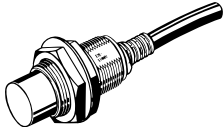

E2EM-X16MX□

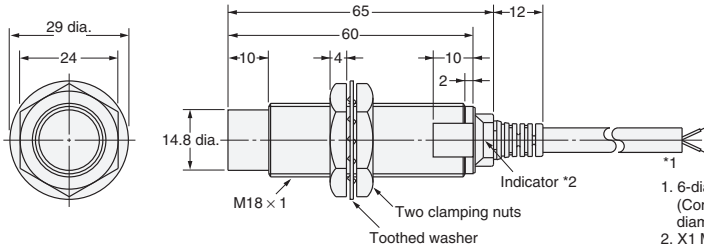

- 6-dia. vinyl-insulated round cable with 2 conductors (Conductor cross section: 0.5 mm², Insulator diameter: 1.9 mm), Standard length: 2 m
- X1 Models: Operation indicator (red), Setting indicator (green)
X2 Models: Operation indicator (red)

E2EM-X30MX□

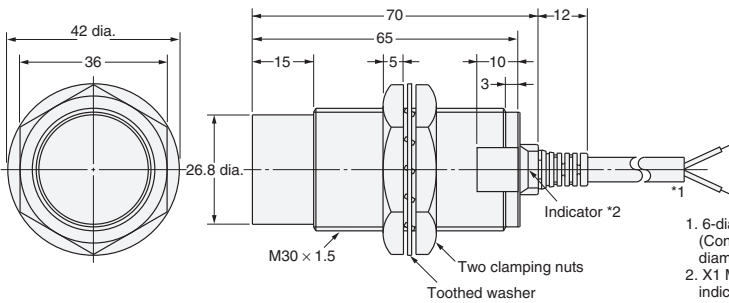

- 6-dia. vinyl-insulated round cable with 2 conductors (Conductor cross section: 0.5 mm², Insulator diameter: 1.9 mm), Standard length: 2 m
- X1 Models: Operation indicator (red), Setting indicator (green)
X2 Models: Operation indicator (red)

Connector Models
(Shielded)

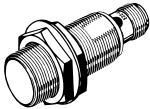

Mounting Hole Dimensions



| Dimensions | M8 | M12 | M18 | M30 |
|------------|---------------------------------------|--|--|--|
| F (mm) | 8.5 ^{+0.5} ₀ dia. | 12.5 ^{+0.5} ₀ dia. | 18.5 ^{+0.5} ₀ dia. | 30.5 ^{+0.5} ₀ dia. |

E2EM-X2C□-M1

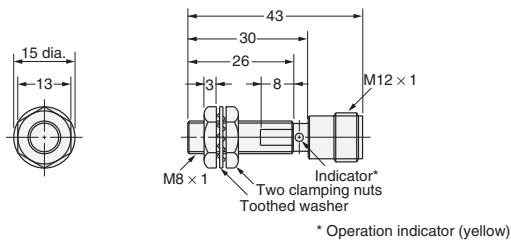

E2EM-X4C□-M1

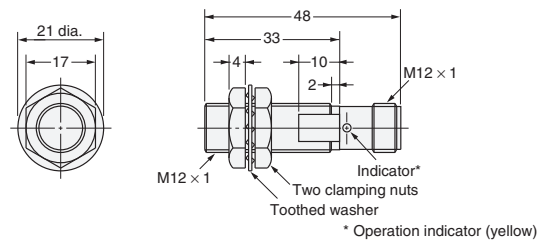

E2EM-X8C□-M1

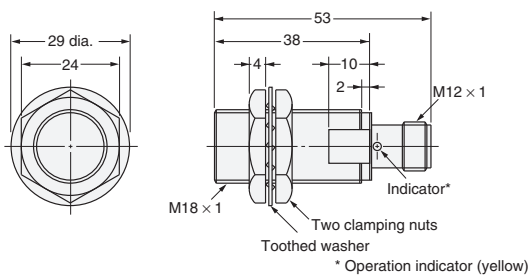

E2EM-X15C□-M1

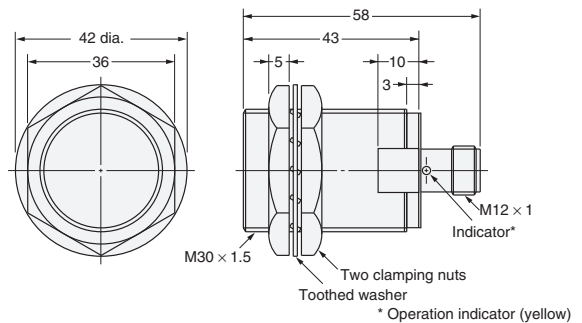

Terms and Conditions Agreement

Read and understand this catalog.

Please read and understand this catalog before purchasing the products. Please consult your OMRON representative if you have any questions or comments.

Warranties.

(a) Exclusive Warranty. Omron's exclusive warranty is that the Products will be free from defects in materials and workmanship for a period of twelve months from the date of sale by Omron (or such other period expressed in writing by Omron). Omron disclaims all other warranties, express or implied.

(b) Limitations. OMRON MAKES NO WARRANTY OR REPRESENTATION, EXPRESS OR IMPLIED, ABOUT NON-INFRINGEMENT, MERCHANTABILITY OR FITNESS FOR A PARTICULAR PURPOSE OF THE PRODUCTS. BUYER ACKNOWLEDGES THAT IT ALONE HAS DETERMINED THAT THE PRODUCTS WILL SUITABLY MEET THE REQUIREMENTS OF THEIR INTENDED USE.

Omron further disclaims all warranties and responsibility of any type for claims or expenses based on infringement by the Products or otherwise of any intellectual property right. (c) Buyer Remedy. Omron's sole obligation hereunder shall be, at Omron's election, to (i) replace (in the form originally shipped with Buyer responsible for labor charges for removal or replacement thereof) the non-complying Product, (ii) repair the non-complying Product, or (iii) repay or credit Buyer an amount equal to the purchase price of the non-complying Product; provided that in no event shall Omron be responsible for warranty, repair, indemnity or any other claims or expenses regarding the Products unless Omron's analysis confirms that the Products were properly handled, stored, installed and maintained and not subject to contamination, abuse, misuse or inappropriate modification. Return of any Products by Buyer must be approved in writing by Omron before shipment. Omron Companies shall not be liable for the suitability or unsuitability or the results from the use of Products in combination with any electrical or electronic components, circuits, system assemblies or any other materials or substances or environments. Any advice, recommendations or information given orally or in writing, are not to be construed as an amendment or addition to the above warranty.

See <http://www.omron.com/global/> or contact your Omron representative for published information.

Limitation on Liability; Etc.

OMRON COMPANIES SHALL NOT BE LIABLE FOR SPECIAL, INDIRECT, INCIDENTAL, OR CONSEQUENTIAL DAMAGES, LOSS OF PROFITS OR PRODUCTION OR COMMERCIAL LOSS IN ANY WAY CONNECTED WITH THE PRODUCTS, WHETHER SUCH CLAIM IS BASED IN CONTRACT, WARRANTY, NEGLIGENCE OR STRICT LIABILITY.

Further, in no event shall liability of Omron Companies exceed the individual price of the Product on which liability is asserted.

Suitability of Use.

Omron Companies shall not be responsible for conformity with any standards, codes or regulations which apply to the combination of the Product in the Buyer's application or use of the Product. At Buyer's request, Omron will provide applicable third party certification documents identifying ratings and limitations of use which apply to the Product. This information by itself is not sufficient for a complete determination of the suitability of the Product in combination with the end product, machine, system, or other application or use. Buyer shall be solely responsible for determining appropriateness of the particular Product with respect to Buyer's application, product or system. Buyer shall take application responsibility in all cases.

NEVER USE THE PRODUCT FOR AN APPLICATION INVOLVING SERIOUS RISK TO LIFE OR PROPERTY OR IN LARGE QUANTITIES WITHOUT ENSURING THAT THE SYSTEM AS A WHOLE HAS BEEN DESIGNED TO ADDRESS THE RISKS, AND THAT THE OMRON PRODUCT(S) IS PROPERLY RATED AND INSTALLED FOR THE INTENDED USE WITHIN THE OVERALL EQUIPMENT OR SYSTEM.

Programmable Products.

Omron Companies shall not be responsible for the user's programming of a programmable Product, or any consequence thereof.

Performance Data.

Data presented in Omron Company websites, catalogs and other materials is provided as a guide for the user in determining suitability and does not constitute a warranty. It may represent the result of Omron's test conditions, and the user must correlate it to actual application requirements. Actual performance is subject to the Omron's Warranty and Limitations of Liability.

Change in Specifications.

Product specifications and accessories may be changed at any time based on improvements and other reasons. It is our practice to change part numbers when published ratings or features are changed, or when significant construction changes are made. However, some specifications of the Product may be changed without any notice. When in doubt, special part numbers may be assigned to fix or establish key specifications for your application. Please consult with your Omron's representative at any time to confirm actual specifications of purchased Product.

Errors and Omissions.

Information presented by Omron Companies has been checked and is believed to be accurate; however, no responsibility is assumed for clerical, typographical or proofreading errors or omissions.

Mouser Electronics

Authorized Distributor

Click to View Pricing, Inventory, Delivery & Lifecycle Information:

Omron:

[E2EM-X8X1-2M](#) [E2EM-X15X1-2M](#) [E2EM-X4X1-2M](#) [E2EM-X30MX1-2M](#) [E2EM-C30X1-M1GJ-1 0.3M](#) [E2EM-X15B1-M1J 0.3M](#) [E2EM-X15X1-M1J 0.3M](#) [E2EM-C30X15-M1GJ-1 0.3M](#) [E2EM-X15C2 2M](#) [E2EM-X4C2 2M](#) [E2EM-X15X2 2M](#) [E2EM-X8X1 5M](#) [E2EM-X15B1-2M](#) [E2EM-X4C1-2M](#) [E2EM-X2B1-2M](#) [E2EM-X16MX1-2M](#) [E2EM-X8C1-2M](#) [E2EM-X30MX2-2M](#) [E2EM-X8B1-2M](#) [E2EM-X16MX2-2M](#) [E2EM-X15C1-2M](#) [E2EM-X4B1-2M](#) [E2EM-X2C1-2M](#) [E2EM-X15C2-M1](#) [E2EM-X2B1-M1](#) [E2EM-X8B1-M1](#) [E2EM-X15B2-M1](#) [E2EM-X4B1-M1](#) [E2EM-X8X2 2M](#) [E2EM-X15B1-M1](#) [E2EM-X2C2 2M](#) [E2EM-X8C2 2M](#) [E2EM-X4X2 2M](#) [E2EM-X2B2-M1](#) [E2EM-X4B2-M1](#) [E2EM-X2C1-M1](#) [E2EM-X2B2 2M](#) [E2EM-X4B2 2M](#) [E2EM-X4C1-M1](#) [E2EM-X8B2-M1](#) [E2EM-X4C2-M1](#) [E2EM-X2C2-M1](#) [E2EM-X8B2 2M](#) [E2EM-X15C1-M1](#) [E2EM-X30MX1-M1J 0.3M](#) [E2EM-X8C2-M1](#) [E2EM-X15B2 2M](#) [E2EM-X8C1-M1](#)

Компания «Океан Электроники» предлагает заключение долгосрочных отношений при поставках импортных электронных компонентов на взаимовыгодных условиях!

Наши преимущества:

- Поставка оригинальных импортных электронных компонентов напрямую с производств Америки, Европы и Азии, а так же с крупнейших складов мира;
- Широкая линейка поставок активных и пассивных импортных электронных компонентов (более 30 млн. наименований);
- Поставка сложных, дефицитных, либо снятых с производства позиций;
- Оперативные сроки поставки под заказ (от 5 рабочих дней);
- Экспресс доставка в любую точку России;
- Помощь Конструкторского Отдела и консультации квалифицированных инженеров;
- Техническая поддержка проекта, помощь в подборе аналогов, поставка прототипов;
- Поставка электронных компонентов под контролем ВП;
- Система менеджмента качества сертифицирована по Международному стандарту ISO 9001;
- При необходимости вся продукция военного и аэрокосмического назначения проходит испытания и сертификацию в лаборатории (по согласованию с заказчиком);
- Поставка специализированных компонентов военного и аэрокосмического уровня качества (Xilinx, Altera, Analog Devices, Intersil, Interpoint, Microsemi, Actel, Aeroflex, Peregrine, VPT, Syfer, Eurofarad, Texas Instruments, MS Kennedy, Miteq, Cobham, E2V, MA-COM, Hittite, Mini-Circuits, General Dynamics и др.);

Компания «Океан Электроники» является официальным дистрибьютором и эксклюзивным представителем в России одного из крупнейших производителей разъемов военного и аэрокосмического назначения «**JONHON**», а так же официальным дистрибьютором и эксклюзивным представителем в России производителя высокотехнологичных и надежных решений для передачи СВЧ сигналов «**FORSTAR**».



JONHON

«**JONHON**» (основан в 1970 г.)

Разъемы специального, военного и аэрокосмического назначения:

(Применяются в военной, авиационной, аэрокосмической, морской, железнодорожной, горно- и нефтедобывающей отраслях промышленности)

«**FORSTAR**» (основан в 1998 г.)

ВЧ соединители, коаксиальные кабели,
кабельные сборки и микроволновые компоненты:

(Применяются в телекоммуникациях гражданского и специального назначения, в средствах связи, РЛС, а так же военной, авиационной и аэрокосмической отраслях промышленности).



Телефон: 8 (812) 309-75-97 (многоканальный)

Факс: 8 (812) 320-03-32

Электронная почта: ocean@oceanchips.ru

Web: <http://oceanchips.ru/>

Адрес: 198099, г. Санкт-Петербург, ул. Калинина, д. 2, корп. 4, лит. А