

EL7535

Monolithic 350mA Step-Down Regulator

FN7003  
 Rev 7.00  
 December 9, 2015

The EL7535 is a synchronous, integrated FET 350mA step-down regulator in a 10 Ld MSOP package. The regulator is internally compensated, which makes it possible to use just five tiny external components to form a complete DC/DC converter. The regulator operates with an input voltage range from 2.5V to 6V, which accommodates supplies of 3.3V, 5V, or a Li-Ion battery source. The output can be externally set from 0.8V to  $V_{IN}$  with a resistive divider.

The EL7535 features PWM mode control. The operating frequency is typically 1.4MHz. Additional features include <math>1\mu A</math> shut-down current, short-circuit protection, and over-temperature protection.

The EL7535 is available in the 10 Ld MSOP package and is specified for operation over the full  $-40^{\circ}C$  to  $+85^{\circ}C$  temperature range.

Ordering Information

PART NUMBER	PART MARKING	PACKAGE	PKG. DWG. #
EL7535IYZ* (Note)	BAACA	10 Ld MSOP (Pb-free)	MDP0043

\*Add "-T7" or "-T13" suffix for tape and reel. Please refer to TB347 for details on reel specifications.

NOTE: These Intersil Pb-free plastic packaged products employ special Pb-free material sets; molding compounds/die attach materials and 100% matte tin plate PLUS ANNEAL - e3 termination finish, which is RoHS compliant and compatible with both SnPb and Pb-free soldering operations. Intersil Pb-free products are MSL classified at Pb-free peak reflow temperatures that meet or exceed the Pb-free requirements of IPC/JEDEC J STD-020.

Pinout

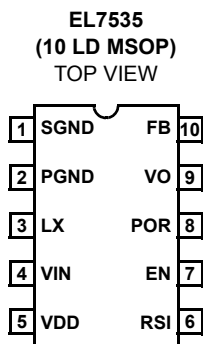

Features

- Extremely Small 350mA DC/DC Converter
- Max Height 1.1mm 10 Ld MSOP Package
- Possibly Uses Only Five Tiny External Components with Fixed Output
- Power-On-Reset Output (POR)
- Internally-Compensated Voltage Mode Controller
- Up to 94% Efficiency
- <math>1\mu A</math> Shut-Down Current
- Overcurrent and Over-Temperature Protection
- Pb-free Available (RoHS compliant)

Applications

- PDA and Pocket PC Computers
- Bar Code Readers
- Cellular Phones
- Portable Test Equipment
- Li-Ion Battery Powered Devices
- Small Form Factor (SFP) Modules

Typical Application Diagram

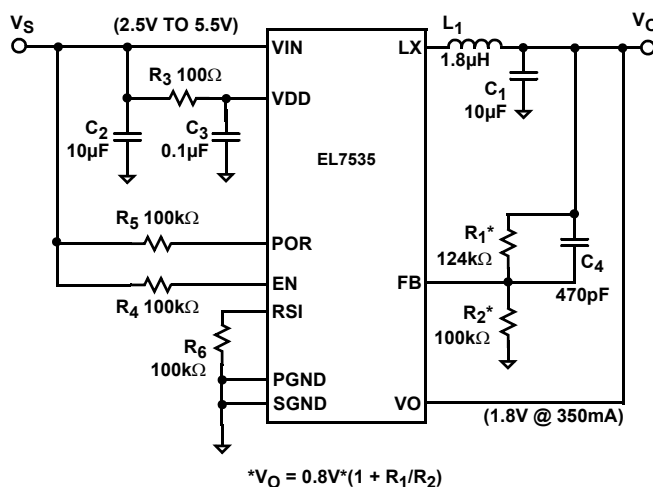

**Absolute Maximum Ratings** ( $T_A = +25^\circ\text{C}$ )

$V_{IN}, V_{DD}$ , POR to SGND	-0.3V to +6.5V
LX to PGND	-0.3V to ( $V_{IN} + 0.3\text{V}$ )
RSI, EN, $V_O$ , FB to SGND	-0.3V to ( $V_{IN} + 0.3\text{V}$ )
PGND to SGND	-0.3V to +0.3V
Peak Output Current	500mA

**Thermal Information**

Operating Ambient Temperature	-40°C to +85°C
Storage Temperature	-65°C to +150°C
Junction Temperature	+125°C
Pb-free reflow profile	see link below
	<a href="http://www.intersil.com/pbfree/Pb-FreeReflow.asp">http://www.intersil.com/pbfree/Pb-FreeReflow.asp</a>

**CAUTION:** Do not operate at or near the maximum ratings listed for extended periods of time. Exposure to such conditions may adversely impact product reliability and result in failures not covered by warranty.

**IMPORTANT NOTE:** All parameters having Min/Max specifications are guaranteed. Typ values are for information purposes only. Unless otherwise noted, all tests are at the specified temperature and are pulsed tests, therefore:  $T_J = T_C = T_A$

**Electrical Specifications**  $V_{DD} = V_{IN} = V_{EN} = 3.3\text{V}$ ,  $C_1 = C_2 = 10\mu\text{F}$ ,  $L = 1.8\mu\text{H}$ ,  $V_O = 1.8\text{V}$ , unless otherwise specified.

PARAMETER	DESCRIPTION	CONDITIONS	MIN	TYP	MAX	UNIT
<b>DC CHARACTERISTICS</b>						
$V_{FB}$	Feedback Input Voltage		780	800	820	mV
$I_{FB}$	Feedback Input Current				250	nA
$V_{IN}, V_{DD}$	Input Voltage		2.5		6	V
$V_{IN,ON}$	Maximum Voltage for Startup	$V_{IN}$ rising	2.19		2.42	V
		Hysteresis	100		300	mV
$I_{DD}$	Supply Current	PWM, $V_{IN} = V_{DD} = 5\text{V}$		400	850	$\mu\text{A}$
		EN = 0, $V_{IN} = V_{DD} = 5\text{V}$		0.1	1.5	$\mu\text{A}$
$r_{DS(ON)-PMOS}$	PMOS FET Resistance	$V_{DD} = 5\text{V}$ , wafer test only		70	100	$\text{m}\Omega$
$r_{DS(ON)-NMOS}$	NMOS FET Resistance	$V_{DD} = 5\text{V}$ , wafer test only		45	75	$\text{m}\Omega$
$I_{LMAX}$	Current Limit			1.5		A
$T_{OT,OFF}$	Over-temperature Threshold	T rising		145		$^\circ\text{C}$
$T_{OT,ON}$	Over-temperature Hysteresis	T falling		130		$^\circ\text{C}$
$I_{EN}, I_{RSI}$	EN, RSI Current	$V_{EN}, V_{RSI} = 0\text{V}$ and 3.3V	-1		1	$\mu\text{A}$
$V_{EN1}, V_{RSI1}$	EN, RSI Rising Threshold	$V_{DD} = 3.3\text{V}$			2.4	V
$V_{EN2}, V_{RSI2}$	EN, RSI Falling Threshold	$V_{DD} = 3.3\text{V}$	0.8			V
$V_{POR}$	Minimum $V_{FB}$ for POR, WRT Targeted $V_{FB}$ Value	$V_{FB}$ rising			97	%
		$V_{FB}$ falling	86			%
$V_{OLPOR}$	POR Voltage Drop	$I_{SINK} = 5\text{mA}$		35	70	mV
<b>AC CHARACTERISTICS</b>						
$f_{PWM}$	PWM Switching Frequency		1.1	1.4	1.6	MHz
$t_{RSI}$	Minimum RSI Pulse Width	Limits established by characterization and are not production tested		25	50	ns
$t_{SS}$	Soft-start Time			650		$\mu\text{s}$
$t_{POR}$	Power-On Reset Delay Time			100		ms

## Pin Descriptions

PIN NUMBER	PIN NAME	PIN FUNCTION
1	SGND	Negative supply for the controller stage
2	PGND	Negative supply for the power stage
3	LX	Inductor drive pin; high current digital output with average voltage equal to the regulator output voltage
4	VIN	Positive supply for the power stage
5	VDD	Power supply for the controller stage
6	RSI	Resets POR timer
7	EN	Enable
8	POR	Power on reset open drain output
9	VO	Output voltage sense
10	FB	Voltage feedback input; connected to an external resistor divider between $V_O$ and SGND for variable output

## Timing Diagram

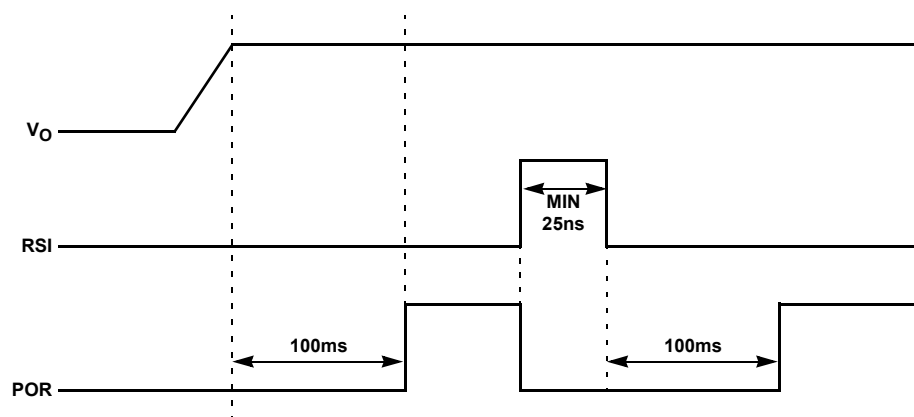

### Block Diagram

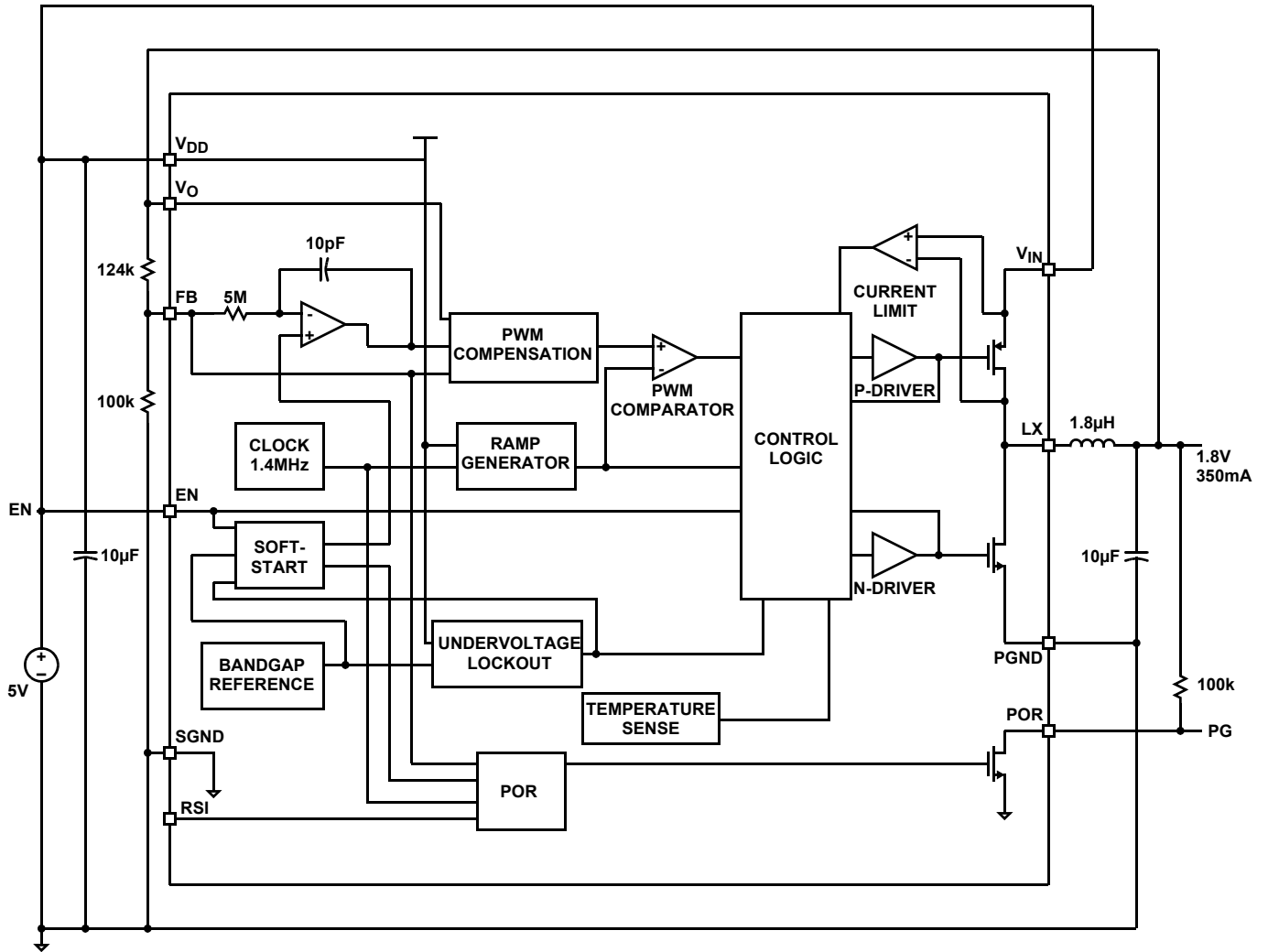

**Typical Performance Curves**

All waveforms are taken at  $V_{IN} = 3.3V$ ,  $V_O = 1.8V$ ,  $I_O = 350mA$  with component values shown on page 1, unless otherwise noted.

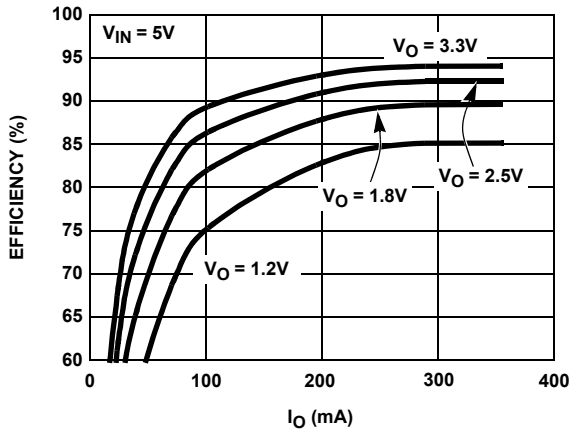

FIGURE 1. EFFICIENCY

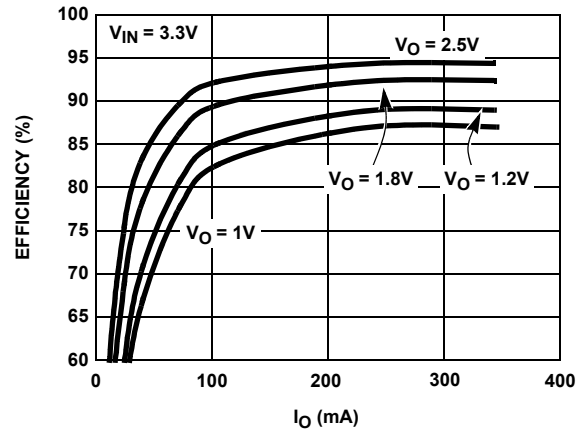

FIGURE 2. EFFICIENCY

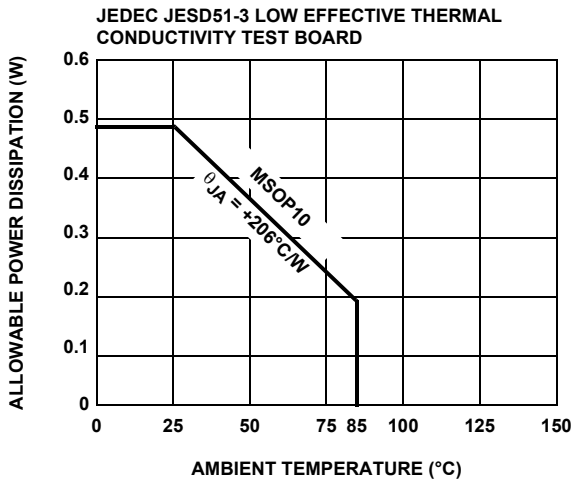

FIGURE 3. PACKAGE POWER DISSIPATION vs AMBIENT TEMPERATURE

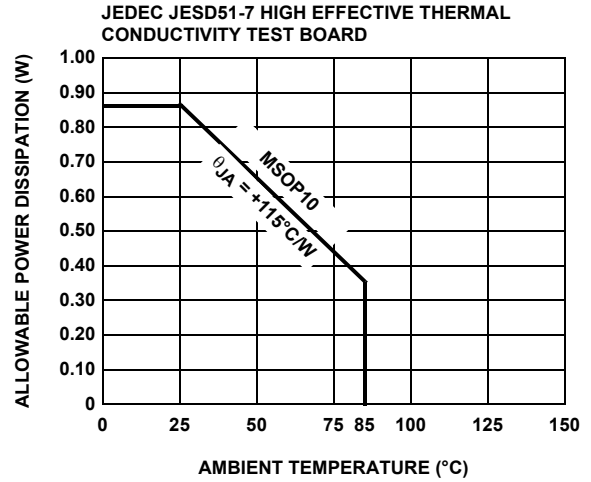

FIGURE 4. PACKAGE POWER DISSIPATION vs AMBIENT TEMPERATURE

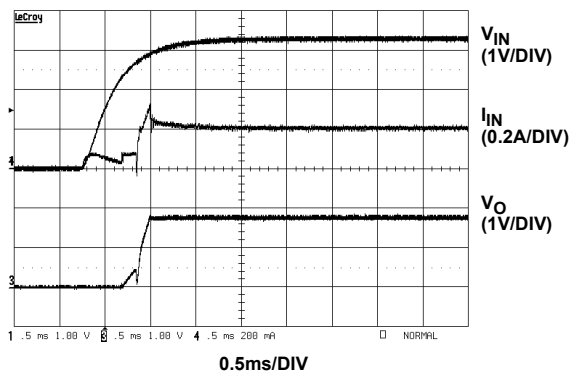

FIGURE 5. START-UP 1

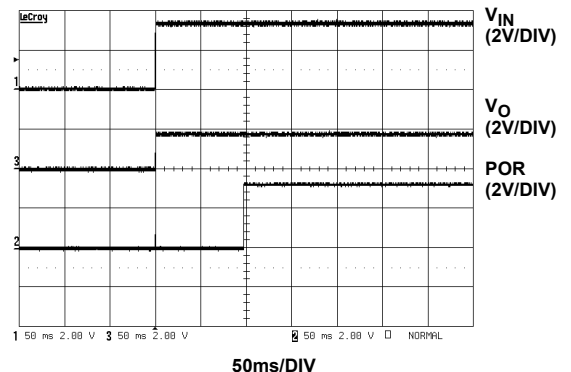
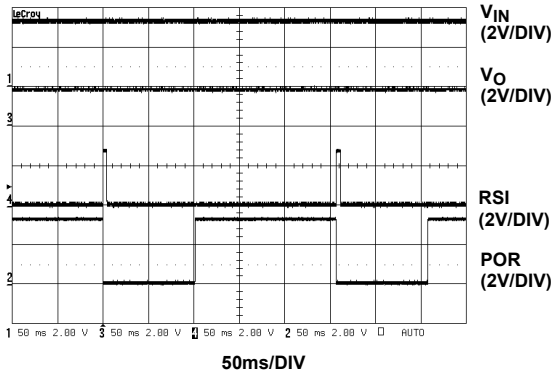

FIGURE 6. START-UP 2

**Typical Performance Curves**

All waveforms are taken at  $V_{IN} = 3.3V$ ,  $V_O = 1.8V$ ,  $I_O = 350mA$  with component values shown on page 1, unless otherwise noted. **(Continued)**



**FIGURE 7. POR FUNCTION**

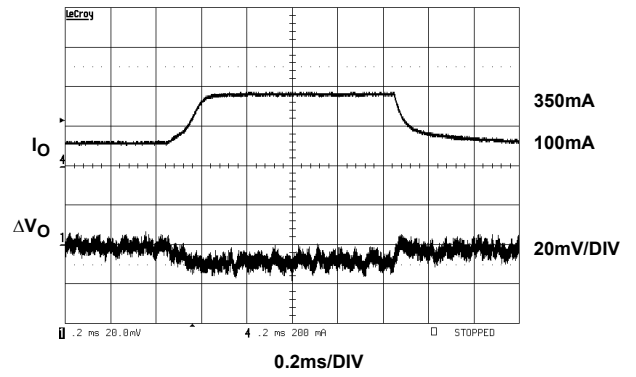

**FIGURE 8. TRANSIENT RESPONSE**

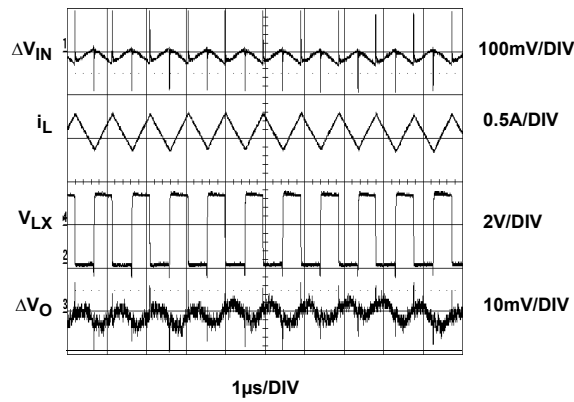

**FIGURE 9. STEADY-STATE**

## Applications Information

### Product Description

The EL7535 is a synchronous, integrated FET 350mA step-down regulator which operates from an input of 2.5V to 6V. The output voltage is user-adjustable with a pair of external resistors.

The internally-compensated controller makes it possible to use only two ceramic capacitors and one inductor to form a complete, very small footprint 350mA DC/DC converter.

### PWM Operation

In the PWM mode, the P-Channel MOSFET and N-Channel MOSFET always operate complementary. When the PMOSFET is on and the NMOSFET off, the inductor current increases linearly. The input energy is transferred to the output and also stored in the inductor. When the P-Channel MOSFET is off and the N-Channel MOSFET on, the inductor current decreases linearly and energy is transferred from the inductor to the output. Hence, the average current through the inductor is the output current. Since the inductor and the output capacitor act as a low pass filter, the duty cycle ratio is approximately equal to  $V_O$  divided by  $V_{IN}$ .

The output LC filter has a second order effect. To maintain the stability of the converter, the overall controller must be compensated. This is done with the fixed internally compensated error amplifier and the PWM compensator. Because the compensations are fixed, the values of input and output capacitors are 10 $\mu$ F to 22 $\mu$ F ceramic. The inductor is nominally 1.8 $\mu$ H, though 1.5 $\mu$ A to 2.2 $\mu$ H can be used.

### Start-Up and Shut-Down

When the EN pin is tied to  $V_{IN}$ , and  $V_{IN}$  reaches approximately 2.4V, the regulator begins to switch. The output voltage is gradually increased to ensure proper soft-start operation.

When the EN pin is connected to a logic low, the EL7535 is in the shut-down mode. All the control circuitry and both MOSFETs are off, and  $V_{OUT}$  falls to zero. In this mode, the total input current is less than 1 $\mu$ A.

When the EN reaches logic HI, the regulator repeats the start-up procedure, including the soft-start function.

### RSI/POR Function

When powering up, the open-collector Power-On-Reset output holds low for about 100ms after  $V_O$  reaches the preset voltage. When the active-HI reset signal RSI is issued, POR goes to low immediately and holds for the same period of time after RSI comes back to LOW. The output voltage is unaffected. (Please refer to "Timing Diagram" on page 3). When the function is not used, connect RSI to ground and leave open the pull-up resistor  $R_4$  at POR pin.

The POR output also serves as a 100ms delayed Power Good signal when the pull-up resistor  $R_4$  is installed. The RSI pin needs to be directly (or indirectly through a resistor  $R_6$ ) connected to Ground for this to function properly.

### Output Voltage Selection

Users can set the output voltage of the converter with a resistor divider, which can be chosen based on Equation 1:

$$V_O = 0.8 \times \left( 1 + \frac{R_1}{R_2} \right) \quad (\text{EQ. 1})$$

### Component Selection

Because of the fixed internal compensation, the component choice is relatively narrow. For a regulator with fixed output voltage, only two capacitors and one inductor are required. We recommend 10 $\mu$ F to 22 $\mu$ F multi-layer ceramic capacitors with X5R or X7R rating for both the input and output capacitors, and 1.5 $\mu$ H to 2.2 $\mu$ H inductance for the inductor.

The RMS current present at the input capacitor is decided by Equation 2:

$$I_{INRMS} = \frac{\sqrt{V_{IN} \times (V_{IN} - V_O)}}{V_{IN}} \times I_O \quad (\text{EQ. 2})$$

This is about half of the output current  $I_O$  for all the  $V_O$ . This input capacitor must be able to handle this current.

The inductor peak-to-peak ripple current is given as Equation 3:

$$\Delta I_{IL} = \frac{(V_{IN} - V_O) \times V_O}{L \times V_{IN} \times f_S} \quad (\text{EQ. 3})$$

- L is the inductance
- $f_S$  is the switching frequency (nominally 1.4MHz)

The inductor must be able to handle  $I_O$  for the RMS load current, and to assure that the inductor is reliable, it must handle the 1.5A surge current that can occur during a current limit condition.

In addition to decoupling capacitors and inductor value, it is important to properly size the phase-lead capacitor  $C_4$  (Refer to the Typical Application Diagram). The phase-lead capacitor creates additional phase margin in the control loop by generating a zero and a pole in the transfer function. As a general rule of thumb,  $C_4$  should be sized to start the phase-lead at a frequency of ~2.5kHz. The zero will always appear at lower frequency than the pole and follow Equation 4:

$$f_z = \frac{1}{2\pi R_2 C_4} \quad (\text{EQ. 4})$$

Over a normal range of  $R_2$  (~10k $\Omega$  to 100k $\Omega$ ),  $C_4$  will range from ~470pF to 4700pF. The pole frequency cannot be set once the zero frequency is chosen as it is dictated by the ratio of  $R_1$  and  $R_2$ , which is solely determined by the desired

output set point. Equation 5 shows the pole frequency relationship:

$$f_P = \frac{1}{2\pi(R_1 \parallel R_2)C_4} \quad (\text{EQ. 5})$$

### **Current Limit and Short-Circuit Protection**

The current limit is set at about 1.5A for the PMOS. When a short-circuit occurs in the load, the preset current limit restricts the amount of current available to the output, which causes the output voltage to drop below the preset voltage. In the meantime, the excessive current heats up the regulator until it reaches the thermal shut-down point.

### **Thermal Shut-Down**

Once the junction reaches about +145°C, the regulator shuts down. Both the P-Channel and the N-Channel MOSFETs turn off. The output voltage will drop to zero. With the output MOSFETs turned off, the regulator will soon cool down. Once the junction temperature drops to about +130°C, the regulator will restart again in the same manner as EN pin connects to logic HI.

### **Thermal Performance**

The EL7535 is in a fused-lead 10 Ld MSOP package. Compared with regular 10 Ld MSOP package, the fused-lead package provides lower thermal resistance. The  $\theta_{JA}$  is +100°C/W on a 4-layer board and +125°C/W on 2-layer board. Maximizing the copper area around the pins will further improve the thermal performance.

### **Layout Considerations**

The layout is very important for the converter to function properly. The following PC layout guidelines should be followed:

- Separate the Power Ground ( $\downarrow$ ) and Signal Ground ( $\frac{\perp}{\perp}$ ); connect them only at one point right at the pins
- Place the input capacitor as close to  $V_{IN}$  and PGND pins as possible
- Make the following PC traces as small as possible:
  - from  $L_X$  pin to L
  - from  $C_O$  to PGND
- If used, connect the trace from the FB pin to  $R_1$  and  $R_2$  as close as possible
- Maximize the copper area around the PGND pin
- Place several via holes under the chip to additional ground plane to improve heat dissipation

The demo board is a good example of layout based on this outline. Please refer to the EL7535 Application Note.



---

## Revision History

The revision history provided is for informational purposes only and is believed to be accurate, but not warranted. Please go to the web to make sure that you have the latest revision.

DATE	REVISION	CHANGE
December 9, 2015	FN7003.7	Updated the Ordering Information table on page 1. Added Revision History and About Intersil sections.

---

## About Intersil

Intersil Corporation is a leading provider of innovative power management and precision analog solutions. The company's products address some of the largest markets within the industrial and infrastructure, mobile computing and high-end consumer markets.

For the most updated datasheet, application notes, related documentation and related parts, please see the respective product information page found at [www.intersil.com](http://www.intersil.com).

You may report errors or suggestions for improving this datasheet by visiting [www.intersil.com/ask](http://www.intersil.com/ask).

Reliability reports are also available from our website at [www.intersil.com/support](http://www.intersil.com/support).

## Mini SO Package Family (MSOP)

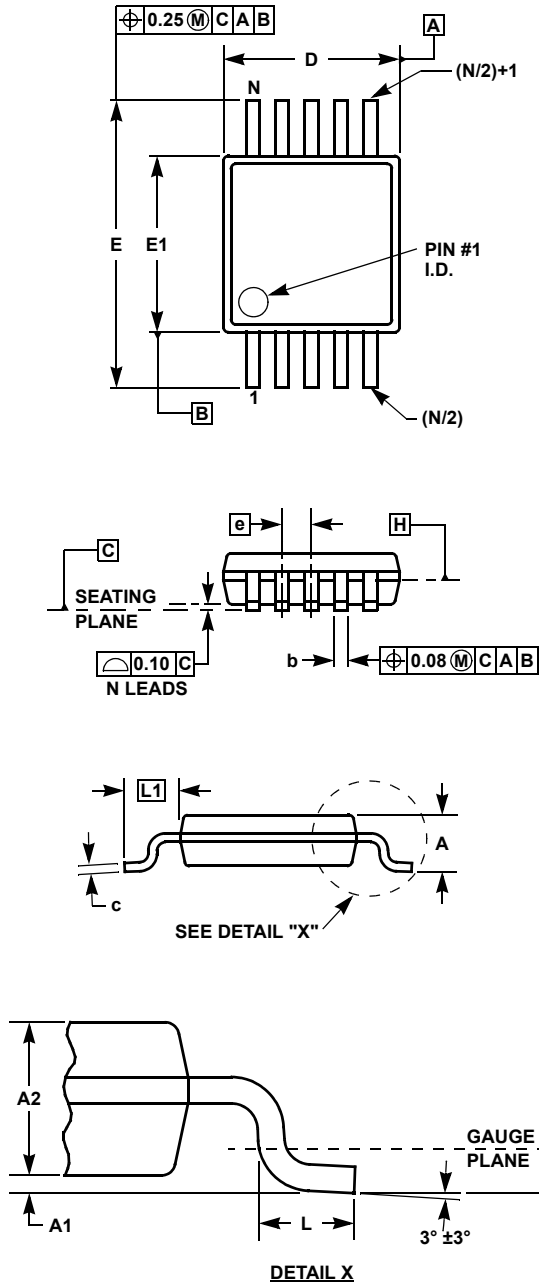

### MDP0043 MINI SO PACKAGE FAMILY

SYMBOL	MILLIMETERS		TOLERANCE	NOTES
	MSOP8	MSOP10		
A	1.10	1.10	Max.	-
A1	0.10	0.10	±0.05	-
A2	0.86	0.86	±0.09	-
b	0.33	0.23	+0.07/-0.08	-
c	0.18	0.18	±0.05	-
D	3.00	3.00	±0.10	1, 3
E	4.90	4.90	±0.15	-
E1	3.00	3.00	±0.10	2, 3
e	0.65	0.50	Basic	-
L	0.55	0.55	±0.15	-
L1	0.95	0.95	Basic	-
N	8	10	Reference	-

Rev. D 2/07

**NOTES:**

1. Plastic or metal protrusions of 0.15mm maximum per side are not included.
2. Plastic interlead protrusions of 0.25mm maximum per side are not included.
3. Dimensions "D" and "E1" are measured at Datum Plane "H".
4. Dimensioning and tolerancing per ASME Y14.5M-1994.

© Copyright Intersil Americas LLC 2004-2015. All Rights Reserved.  
All trademarks and registered trademarks are the property of their respective owners.

For additional products, see [www.intersil.com/en/products.html](http://www.intersil.com/en/products.html)

Intersil products are manufactured, assembled and tested utilizing ISO9001 quality systems as noted in the quality certifications found at [www.intersil.com/en/support/qualandreliability.html](http://www.intersil.com/en/support/qualandreliability.html)

Intersil products are sold by description only. Intersil may modify the circuit design and/or specifications of products at any time without notice, provided that such modification does not, in Intersil's sole judgment, affect the form, fit or function of the product. Accordingly, the reader is cautioned to verify that datasheets are current before placing orders. Information furnished by Intersil is believed to be accurate and reliable. However, no responsibility is assumed by Intersil or its subsidiaries for its use; nor for any infringements of patents or other rights of third parties which may result from its use. No license is granted by implication or otherwise under any patent or patent rights of Intersil or its subsidiaries.

For information regarding Intersil Corporation and its products, see [www.intersil.com](http://www.intersil.com)

Компания «Океан Электроники» предлагает заключение долгосрочных отношений при поставках импортных электронных компонентов на взаимовыгодных условиях!

Наши преимущества:

- Поставка оригинальных импортных электронных компонентов напрямую с производств Америки, Европы и Азии, а так же с крупнейших складов мира;
- Широкая линейка поставок активных и пассивных импортных электронных компонентов (более 30 млн. наименований);
- Поставка сложных, дефицитных, либо снятых с производства позиций;
- Оперативные сроки поставки под заказ (от 5 рабочих дней);
- Экспресс доставка в любую точку России;
- Помощь Конструкторского Отдела и консультации квалифицированных инженеров;
- Техническая поддержка проекта, помощь в подборе аналогов, поставка прототипов;
- Поставка электронных компонентов под контролем ВП;
- Система менеджмента качества сертифицирована по Международному стандарту ISO 9001;
- При необходимости вся продукция военного и аэрокосмического назначения проходит испытания и сертификацию в лаборатории (по согласованию с заказчиком);
- Поставка специализированных компонентов военного и аэрокосмического уровня качества (Xilinx, Altera, Analog Devices, Intersil, Interpoint, Microsemi, Actel, Aeroflex, Peregrine, VPT, Syfer, Eurofarad, Texas Instruments, MS Kennedy, Miteq, Cobham, E2V, MA-COM, Hittite, Mini-Circuits, General Dynamics и др.);

Компания «Океан Электроники» является официальным дистрибьютором и эксклюзивным представителем в России одного из крупнейших производителей разъемов военного и аэрокосмического назначения «JONHON», а так же официальным дистрибьютором и эксклюзивным представителем в России производителя высокотехнологичных и надежных решений для передачи СВЧ сигналов «FORSTAR».



## JONHON

«JONHON» (основан в 1970 г.)

Разъемы специального, военного и аэрокосмического назначения:

(Применяются в военной, авиационной, аэрокосмической, морской, железнодорожной, горно- и нефтедобывающей отраслях промышленности)

«FORSTAR» (основан в 1998 г.)

ВЧ соединители, коаксиальные кабели,  
кабельные сборки и микроволновые компоненты:

(Применяются в телекоммуникациях гражданского и специального назначения, в средствах связи, РЛС, а так же военной, авиационной и аэрокосмической отраслях промышленности).



Телефон: 8 (812) 309-75-97 (многоканальный)

Факс: 8 (812) 320-03-32

Электронная почта: [ocean@oceanchips.ru](mailto:ocean@oceanchips.ru)

Web: <http://oceanchips.ru/>

Адрес: 198099, г. Санкт-Петербург, ул. Калинина, д. 2, корп. 4, лит. А