



User Guide

UG000424

AS6500-DK

Development Kit

Hardware and Graphical User Interface

v1-00 • 2019-Mar-14

Content Guide

1	Introduction.....	3	4.1	Main Window.....	9
1.1	Kit Content & Ordering Information	3	4.2	Menu & Support Windows	11
2	Quick Start Guide	4	5	Schematics, Layers and BOM	14
2.1	Manual Driver Installation.....	5	6	Revision Information.....	17
3	Hardware Description.....	7	7	Legal Information	18
3.1	Introduction.....	7			
3.2	Communication Interface	8			
4	Software Description.....	9			

1 Introduction

1.1 Kit Content & Ordering Information

Figure 1:
Kit Content

AS6500-QF_DK_RB (Based on AS6500 in QFN40 package)



PICOPROG V3.0 (Programmer and interface)



Cable connecting board and PICOPROG



USB cable (Connects PICOPROG V3.0 to PC)



Please download the latest software for the kit from
<https://download.ams.com/SPECIALTY-SENSORS/AS6500>

Ordering Code	Part Number	Description
AS6500-QF_DK	221050003	AS6500 Demo Kit including PICOProg and cables
AS6500-QF_DK_RB	221050002	AS6500 Reference board

2 Quick Start Guide

This section describes how to quickly set up the AS6500-DK, establish basic operation and make measurements.

- It is crucial to install the software before connecting the development kit to your computer:
<https://download.ams.com/SPECIALTY-SENSORS/AS6500>
- Unzip the package to the desired directory, open “setup.exe” and follow the instructions on the screen
- Connect the PICOPROG V3.0 to the computer using the USB cable and connect the board to the PICOPROG using the DB15 connector cable.
- Quick Start for Initial Measurements

From the “Start” menu, go to “All Programs” and then to the “ams AG” directory. Click the “AS6500 Evaluation Software” icon to begin execution of the evaluation software. The following screen should appear:

Figure 2 :
Opening Page

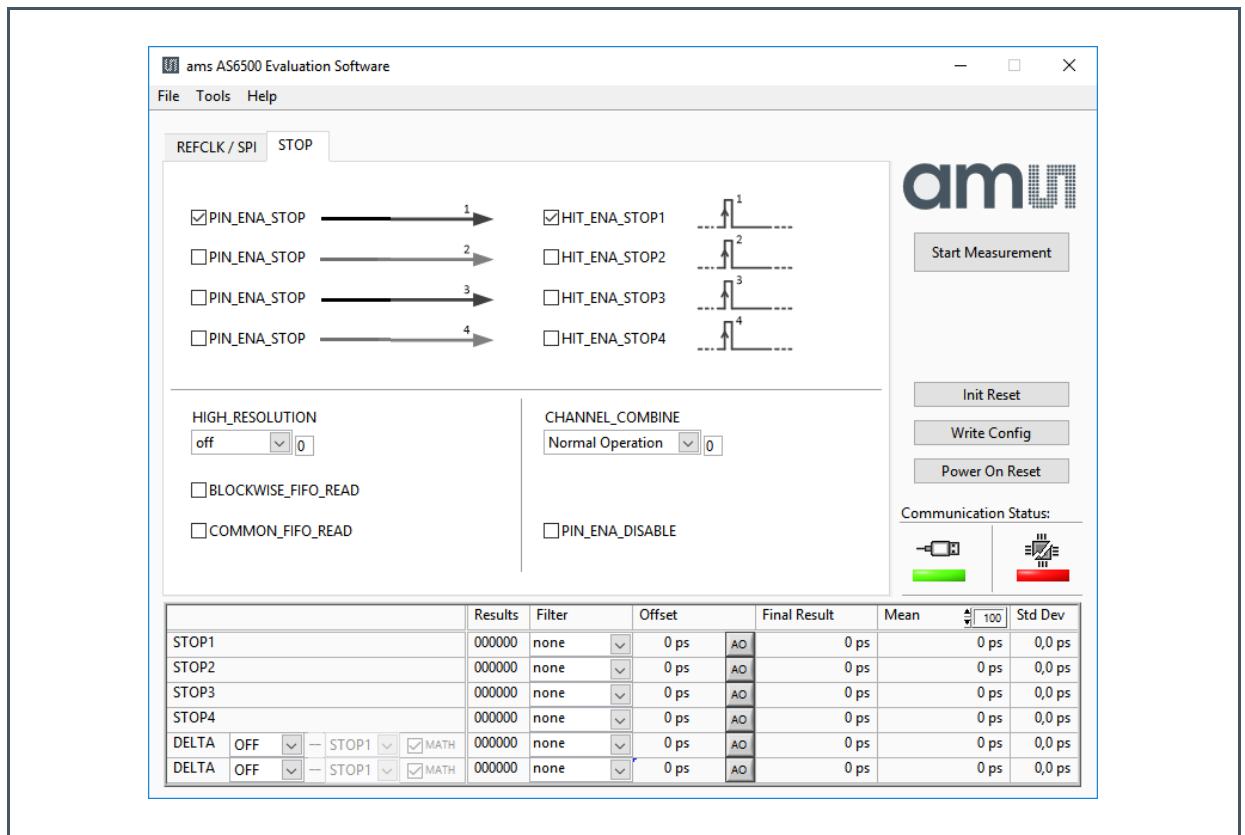

- First click **“Power On Reset”**, **“Write Config”** and **“Init Reset”**.
The lights for the communication status should both become green.
- Enable the channels that are used.
- Check the REFCLK/SPI page settings
- Connect your signal source
- Press **“Start Measurement”**

At this point, after successful completion of the above steps, a basic operation of the development kit should be possible.

Figure 3:
Setup Window

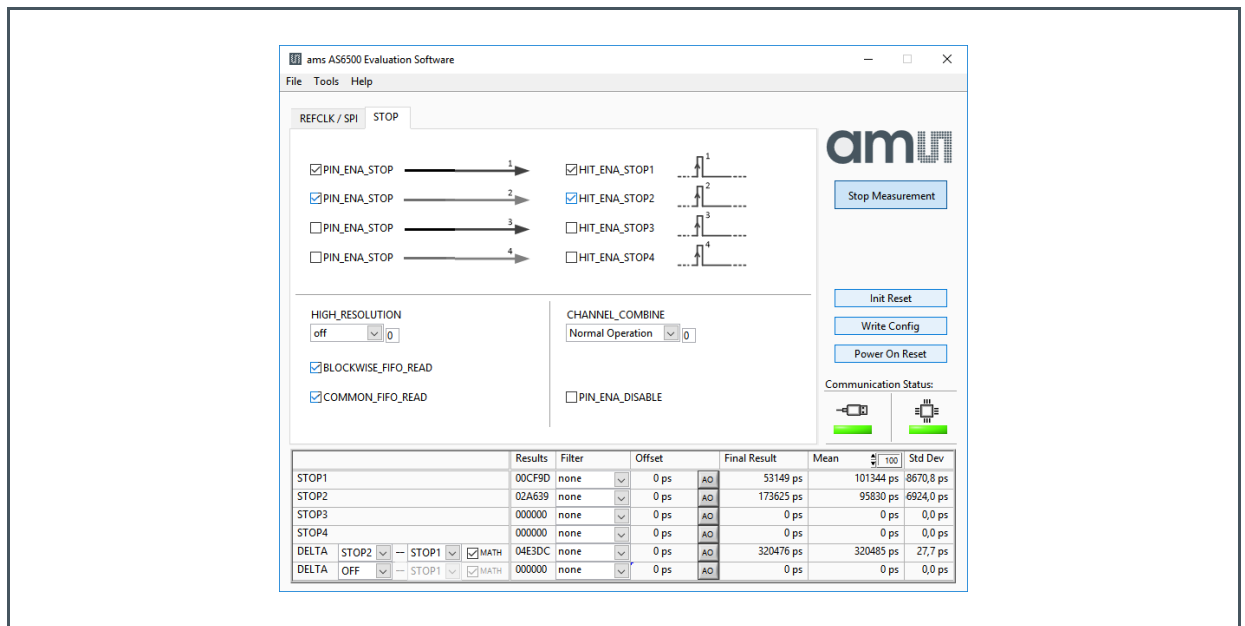

2.1 Manual Driver Installation

If PICOPROG is not displayed correctly then go to the drivers folder, e.g. *C:\Program Files\ams AG\AS6500 Evaluation Software* and install the driver for your operating system manually.

Figure 4:
Device Manager

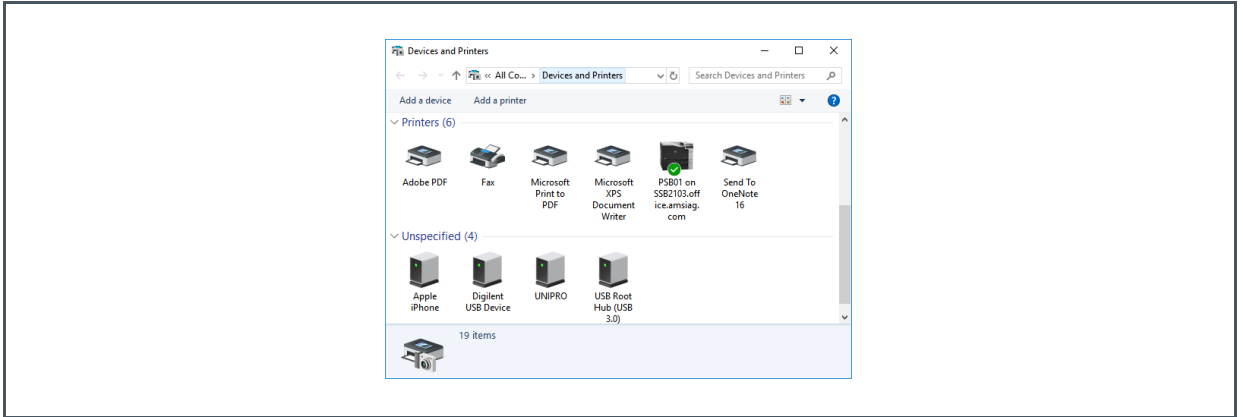

3 Hardware Description

3.1 Introduction

The AS6500-QF_DK_RB board, shown in Figure 5, is a basic board for the 4-channel time-to-digital converter AS6500. The reference clock can be applied from external via pin or from the on-board 4 MHz quartz oscillator (X1).

Figure 5:
AS6500-QF_DK_RB

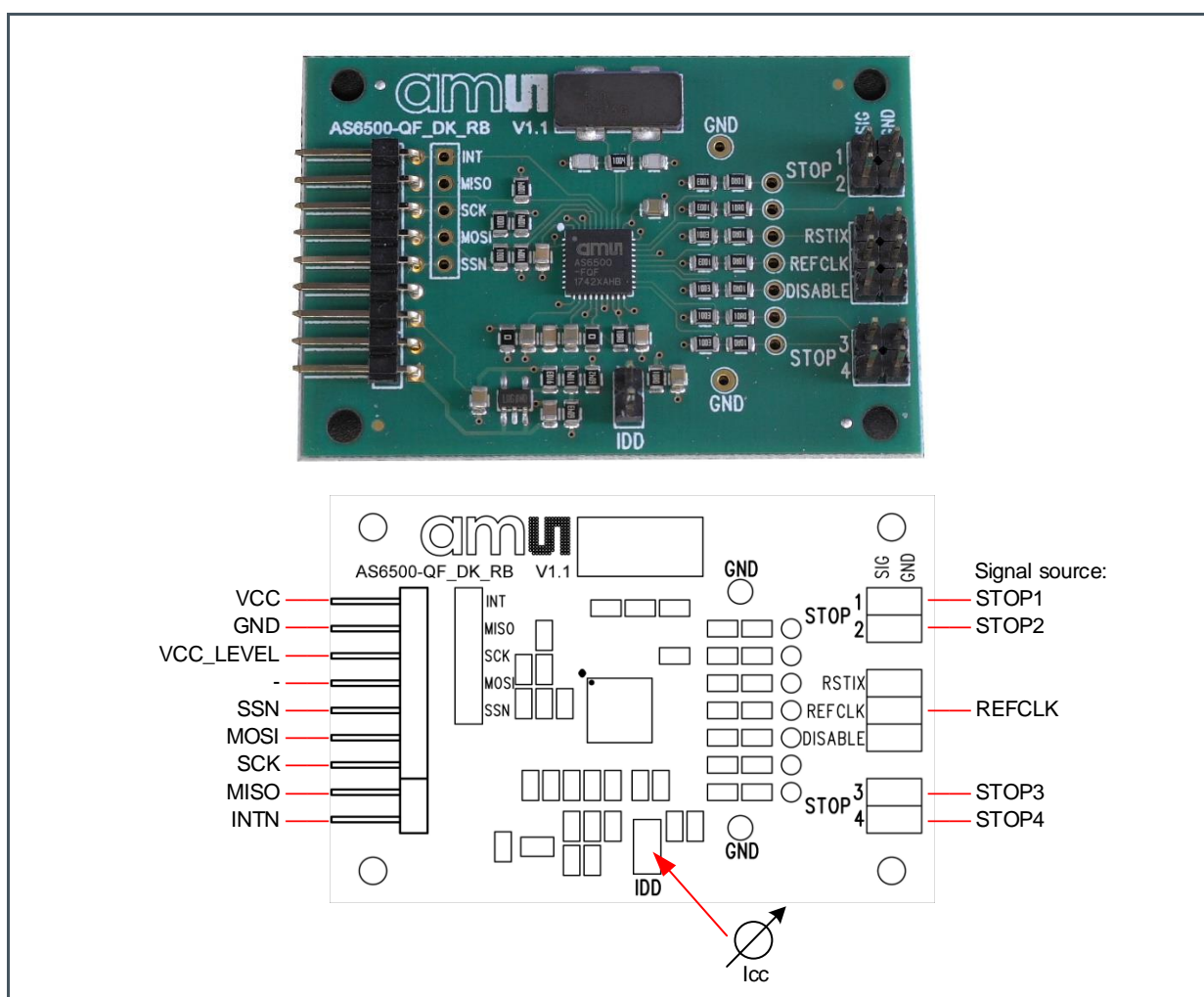

3.2 Communication Interface

The PICOPROG device is a USB-to-SPI converter box that interfaces all UFC evaluation systems. The PICOPROG is registered by the operating system initially as “PICOPROG v2.0 unprogrammed”. As soon as the AS6500-QF_DK_RB evaluation software starts, a special firmware is written into the PICOPROG to handle the SPI communication with the AS6500-DK. The PICOPROG is now listed as “UNIPRO” in the device manager. For SPI communication only, PICOPROG version 2.0 is sufficient.

The flat connector connecting the PICOPROG and the AS6500-QF_DK_RB. includes the power lines and the SPI communication lines. VCC_LEVEL is the voltage feedback for the PICOPROG level shifters.

4 Software Description

4.1 Main Window

The main windows shows two pages for configuration and result display:

4.1.1 Stop Page

On this window major settings are made:

1. Selects the input pins that are used in the application
2. Enable the internal measurement channels. Each pin refers to minimum one internal channel. Two will be needed in case of channel combination.
3. Select the resolution. High resolution achieves a better single-shot rms noise, but at the cost of pulse-pair resolution.
4. Selects optional channel combination
This can be for better pulse-pair resolution or for pulse width measurement. Both options demand internally two channels per stop pin.
5. Having done the settings, download the configuration and initialize the chip.
6. Start the measurement.
7. At the bottom the results for the four stop channels are displayed.
8. In many cases the differences between the channels are of interest. This can be activated here.

Figure 6:
Stop Page

	Results	Filter	Offset	Final Result	Mean	Std Dev					
STOP1	000000	none	0 ps	AO	74418 ps	103995 ps 3055,9 ps					
STOP2	000000	none	0 ps	AO	194953 ps	88495 ps 8833,7 ps					
STOP3	000000	none	0 ps	AO	0 ps	0 ps 0,0 ps					
STOP4	000000	none	0 ps	AO	0 ps	0 ps 0,0 ps					
DELTA	STOP2	---	STOP1	MATH	000000	none	0 ps	AO	320535 ps	320500 ps	34,4 ps
DELTA	OFF	---	STOP1	MATH	000000	none	0 ps	AO	0 ps	0 ps	0,0 ps

4.1.2 REFCLK/SPI Page

Figure 7:
REFCLK/SPI Page

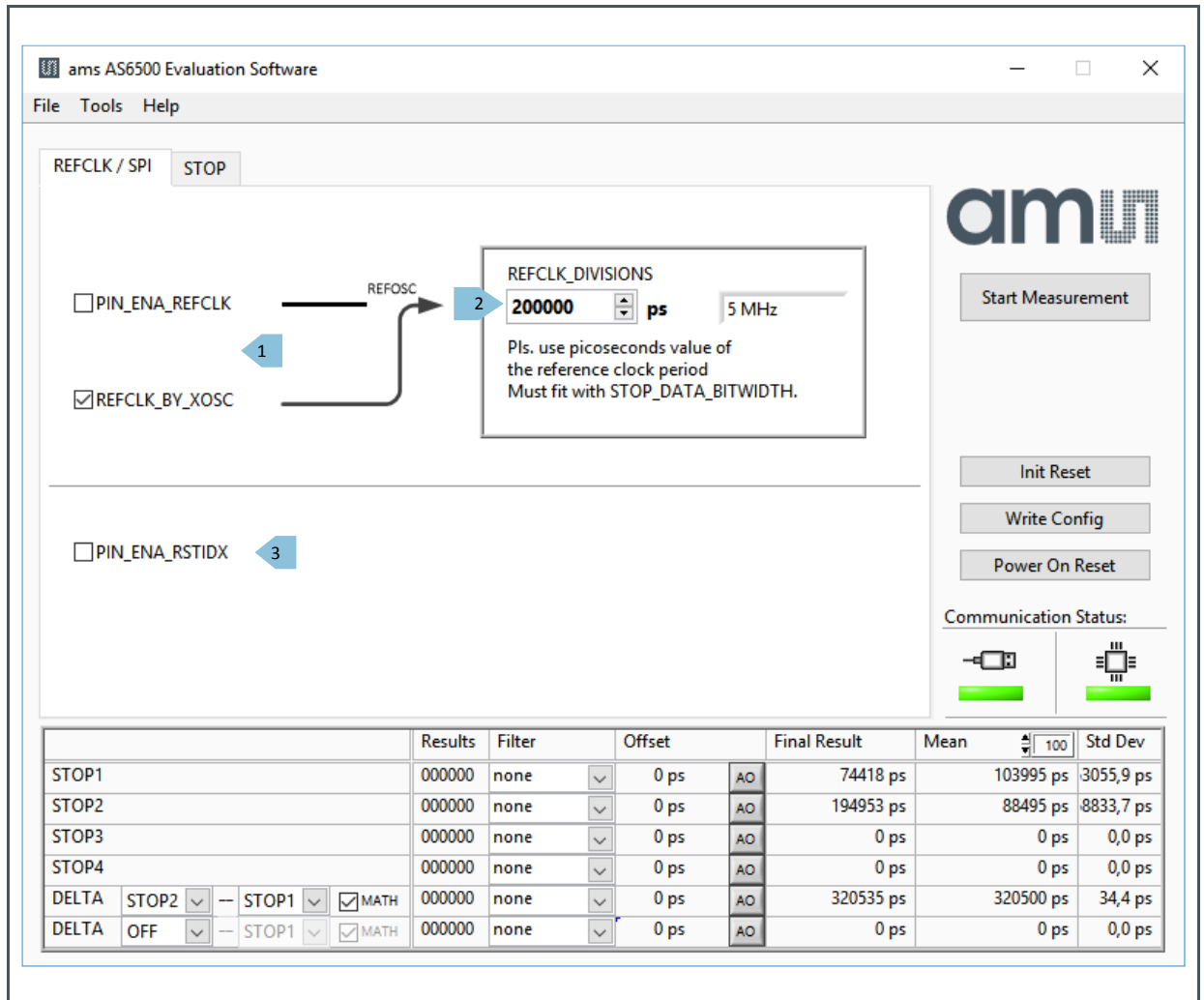

4.2 Menu & Support Windows

Beside main window, the software menu allows the opening of other windows. There are some menu items which are redundant to available buttons of main window.

4.2.1 File

- **Load Config**
This dialog box allows the path selection of a configuration file, covering the register settings, necessary for a proper configuration of the AS6500. After opening this file, the control settings are updated in the GUI.
- **Save Config**
This menu item allows the saving of the current GUI control settings into a configuration file
- **Save Graph Data**
Allows to store the measurement data as they are stored in the data buffer for the graphical display. It is possible to store the STOP data only or the STOP together with the reference numbers.

Figure 8:
File Menu

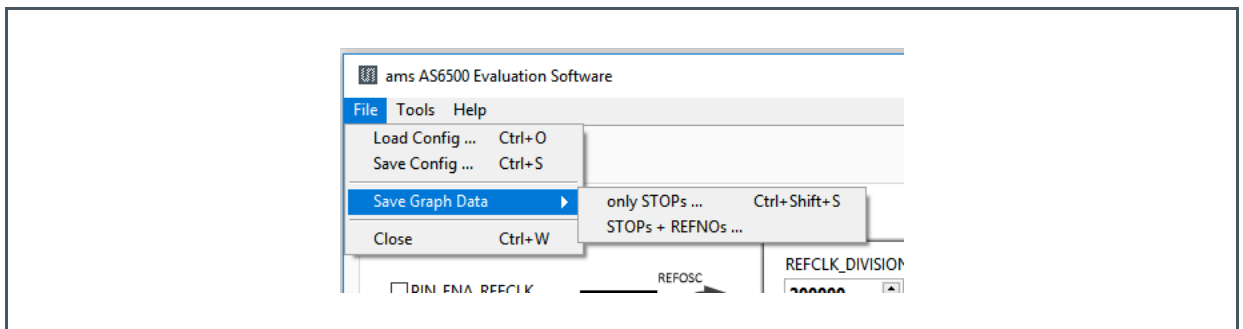

- **Close**
Close all open windows of the AS6500-QF_DK Evaluation software.

4.2.2 Tools

- **Run Measurement**
Same function as "Start/Stop Measurement" button in "Measurement" tab of main window.
- **Graph...**
Opens the window for a graphical display of the measurement data

Figure 9:
Graph Window

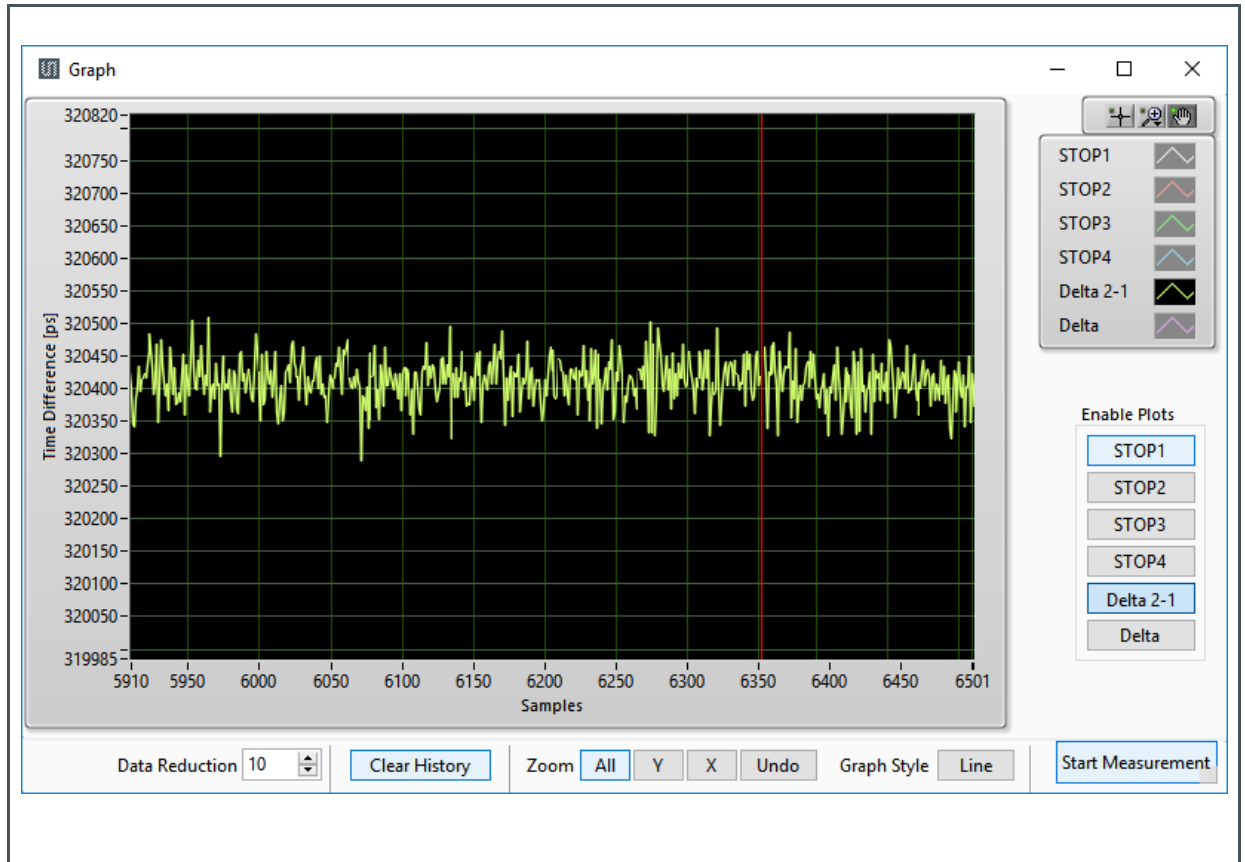

- Registers
Opens a separate window for the display and setting of the configuration registers and the display of the read registers.

Figure 10:
Configuration Registers

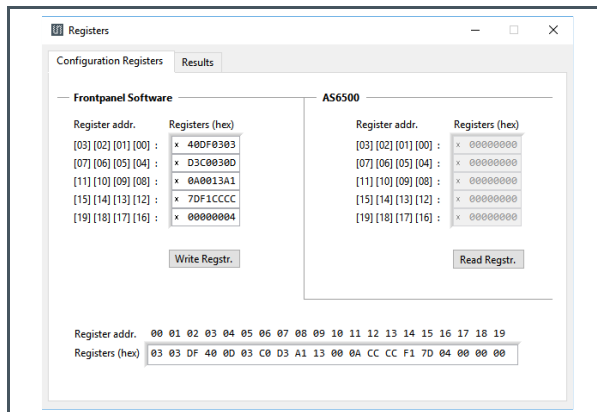
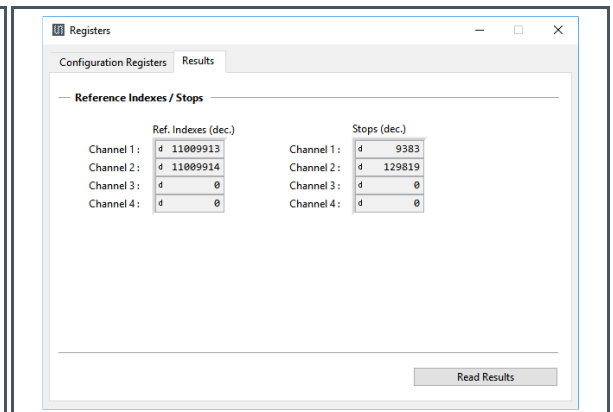

Figure 11:
Result Registers



5 Schematics, Layers and BOM

Figure 12:
AS6500-QF_DK_RB Schematics

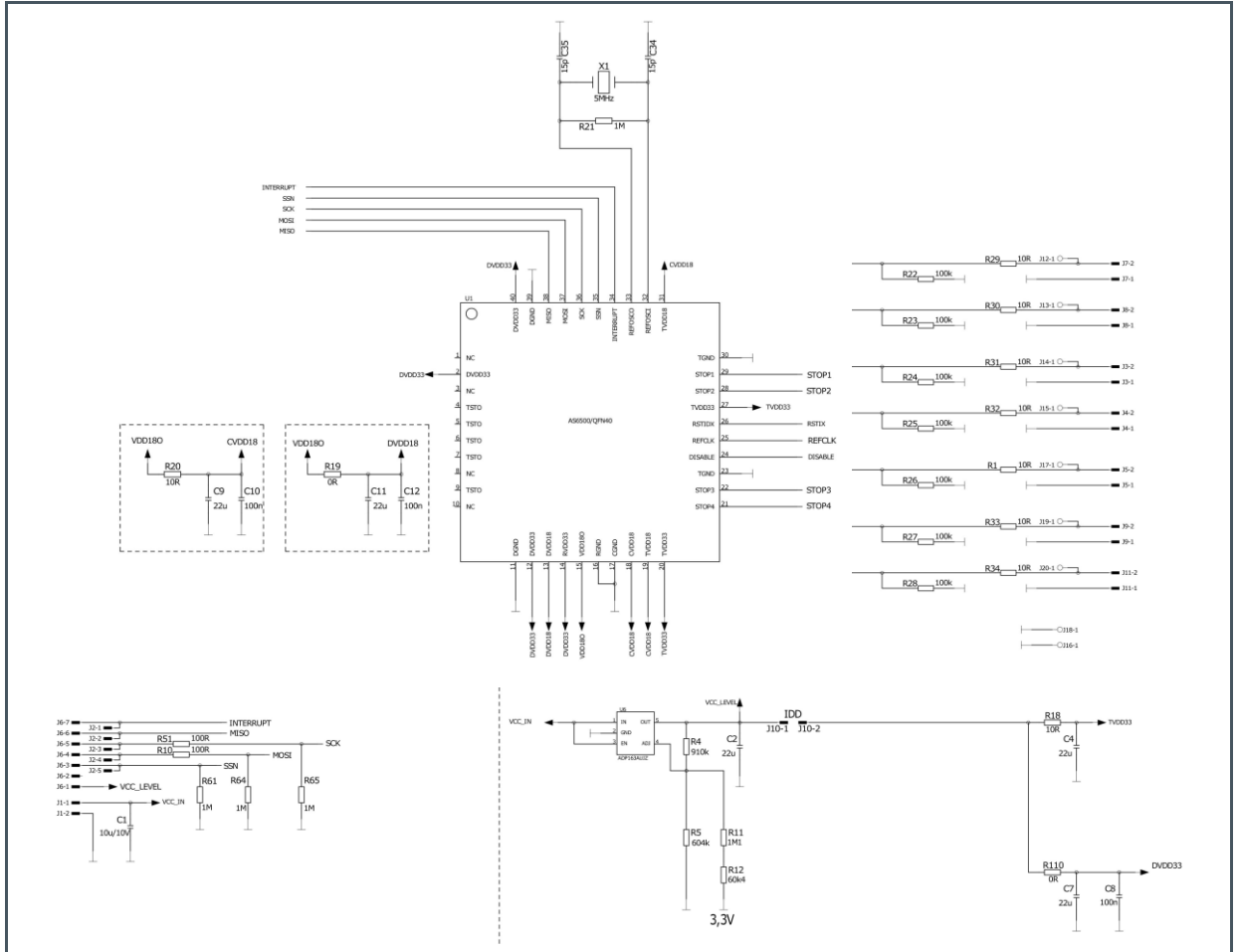

Figure 13:
AS6500-QF_DK_RB Layout & Assembly

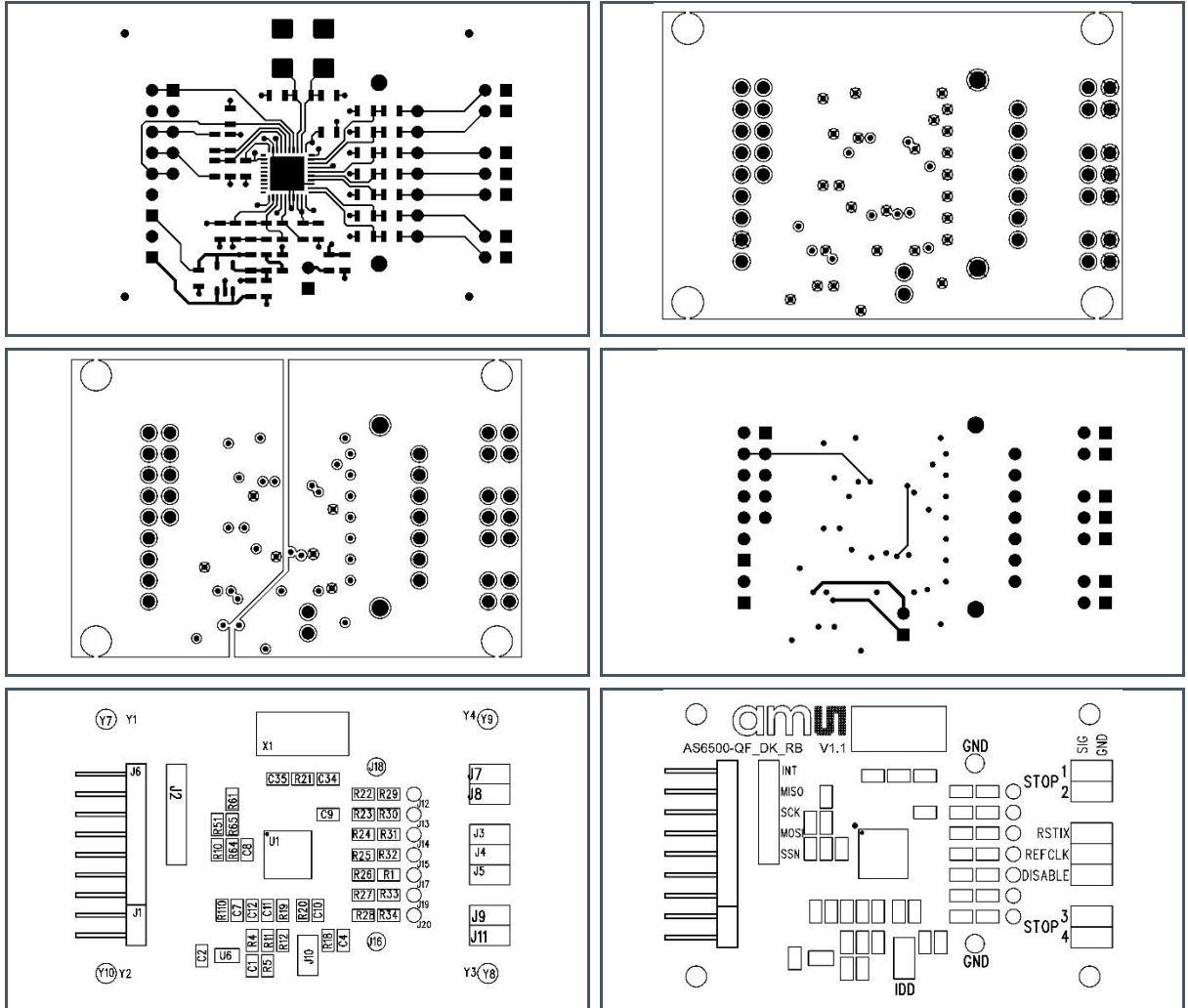

Figure 14:
Bill of Materials for AS6500-QF_DK_RB

Item	Qty	Reference	Value	Part Desc	Type
1	1	U1	AS6500	QFN40	AS6500 TDC ams
2	1	U6	3.0 V	ADP163AUJZ	Linear regulator, Analog Devices
3	1	X1	5 MHz	KX-20	Quartz crystal Geyer
4	3	C8, C10, C12	100 nF	0805	Chip capacitor
5	2	C34,C35	15 pF	0805	Chip capacitor
6	5	C2,C4,C7,C9,C11	22 μF	0805	Chip capacitor
7	2	R19,R110	0 Ω	0805	Chip resistor

Item	Qty	Reference	Value	Part Desc	Type
8	2	R10,R51	100 Ω	0805	Chip resistor
9	7	R22,R23,R24,R25,R26,R27,R28	100 kΩ	0805	Chip resistor
10	9	R1,R18,R20,R29,R30,R31,R32,R33	1 MΩ	0805	Chip resistor
11	4	R21,R61,R64,R65	1.1 MΩ	0805	Chip resistor
12	1	R5	604 kΩ	0805	Chip resistor
13	1	R12	60.4 kΩ	0805	Chip resistor
14	1	R4	910 kΩ	0805	Chip resistor
15	1	R8	10 MΩ	0805	Chip resistor
16	1	J6	7 x 1 x 90°		2.54
17	1	J1	2 x 1 x 90°		2.54
18	1	J2	5 x 1 x 180°		2.54

6 Revision Information

Changes from previous version to current revision v1-00	Page
First edition	All

- Page and figure numbers for the previous version may differ from page and figure numbers in the current revision.
- Correction of typographical errors is not explicitly mentioned.

7 Legal Information

Copyrights & Disclaimer

Copyright ams AG, Tobelbader Strasse 30, 8141 Premstaetten, Austria-Europe. Trademarks Registered. All rights reserved. The material herein may not be reproduced, adapted, merged, translated, stored, or used without the prior written consent of the copyright owner.

Demo Kits, Evaluation Kits and Reference Designs are provided to recipient on an "as is" basis for demonstration and evaluation purposes only and are not considered to be finished end-products intended and fit for general consumer use, commercial applications and applications with special requirements such as but not limited to medical equipment or automotive applications. Demo Kits, Evaluation Kits and Reference Designs have not been tested for compliance with electromagnetic compatibility (EMC) standards and directives, unless otherwise specified. Demo Kits, Evaluation Kits and Reference Designs shall be used by qualified personnel only.

ams AG reserves the right to change functionality and price of Demo Kits, Evaluation Kits and Reference Designs at any time and without notice.

Any express or implied warranties, including, but not limited to the implied warranties of merchantability and fitness for a particular purpose are disclaimed. Any claims and demands and any direct, indirect, incidental, special, exemplary or consequential damages arising from the inadequacy of the provided Demo Kits, Evaluation Kits and Reference Designs or incurred losses of any kind (e.g. loss of use, data or profits or business interruption however caused) as a consequence of their use are excluded.

ams AG shall not be liable to recipient or any third party for any damages, including but not limited to personal injury, property damage, loss of profits, loss of use, interruption of business or indirect, special, incidental or consequential damages, of any kind, in connection with or arising out of the furnishing, performance or use of the technical data herein. No obligation or liability to recipient or any third party shall arise or flow out of ams AG rendering of technical or other services.

RoHS Compliant & ams Green Statement

RoHS Compliant: The term RoHS compliant means that ams AG products fully comply with current RoHS directives. Our semiconductor products do not contain any chemicals for all 6 substance categories, including the requirement that lead not exceed 0.1% by weight in homogeneous materials. Where designed to be soldered at high temperatures, RoHS compliant products are suitable for use in specified lead-free processes.

ams Green (RoHS compliant and no Sb/Br): ams Green defines that in addition to RoHS compliance, our products are free of Bromine (Br) and Antimony (Sb) based flame retardants (Br or Sb do not exceed 0.1% by weight in homogeneous material).

Important Information: The information provided in this statement represents ams AG knowledge and belief as of the date that it is provided. ams AG bases its knowledge and belief on information provided by third parties, and makes no representation or warranty as to the accuracy of such information. Efforts are underway to better integrate information from third parties. ams AG has taken and continues to take reasonable steps to provide representative and accurate information but may not have conducted destructive testing or chemical analysis on incoming materials and chemicals. ams AG and ams AG suppliers consider certain information to be proprietary, and thus CAS numbers and other limited information may not be available for release.

Headquarters

ams AG
Tobelbader Strasse 30
8141 Premstaetten
Austria, Europe
Tel: +43 (0) 3136 500 0

Please visit our website at www.ams.com

Buy our products or get free samples online at www.ams.com/Products

Technical Support is available at www.ams.com/Technical-Support

Provide feedback about this document at www.ams.com/Document-Feedback

For sales offices, distributors and representatives go to www.ams.com/Contact

For further information and requests, e-mail us at ams_sales@ams.com

Компания «Океан Электроники» предлагает заключение долгосрочных отношений при поставках импортных электронных компонентов на взаимовыгодных условиях!

Наши преимущества:

- Поставка оригинальных импортных электронных компонентов напрямую с производств Америки, Европы и Азии, а так же с крупнейших складов мира;
- Широкая линейка поставок активных и пассивных импортных электронных компонентов (более 30 млн. наименований);
- Поставка сложных, дефицитных, либо снятых с производства позиций;
- Оперативные сроки поставки под заказ (от 5 рабочих дней);
- Экспресс доставка в любую точку России;
- Помощь Конструкторского Отдела и консультации квалифицированных инженеров;
- Техническая поддержка проекта, помощь в подборе аналогов, поставка прототипов;
- Поставка электронных компонентов под контролем ВП;
- Система менеджмента качества сертифицирована по Международному стандарту ISO 9001;
- При необходимости вся продукция военного и аэрокосмического назначения проходит испытания и сертификацию в лаборатории (по согласованию с заказчиком);
- Поставка специализированных компонентов военного и аэрокосмического уровня качества (Xilinx, Altera, Analog Devices, Intersil, Interpoint, Microsemi, Actel, Aeroflex, Peregrine, VPT, Syfer, Eurofarad, Texas Instruments, MS Kennedy, Miteq, Cobham, E2V, MA-COM, Hittite, Mini-Circuits, General Dynamics и др.);

Компания «Океан Электроники» является официальным дистрибьютором и эксклюзивным представителем в России одного из крупнейших производителей разъемов военного и аэрокосмического назначения «**JONHON**», а так же официальным дистрибьютором и эксклюзивным представителем в России производителя высокотехнологичных и надежных решений для передачи СВЧ сигналов «**FORSTAR**».



JONHON

«**JONHON**» (основан в 1970 г.)

Разъемы специального, военного и аэрокосмического назначения:

(Применяются в военной, авиационной, аэрокосмической, морской, железнодорожной, горно- и нефтедобывающей отраслях промышленности)

«**FORSTAR**» (основан в 1998 г.)

ВЧ соединители, коаксиальные кабели,
кабельные сборки и микроволновые компоненты:

(Применяются в телекоммуникациях гражданского и специального назначения, в средствах связи, РЛС, а так же военной, авиационной и аэрокосмической отраслях промышленности).



Телефон: 8 (812) 309-75-97 (многоканальный)

Факс: 8 (812) 320-03-32

Электронная почта: ocean@oceanchips.ru

Web: <http://oceanchips.ru/>

Адрес: 198099, г. Санкт-Петербург, ул. Калинина, д. 2, корп. 4, лит. А