

# 2N4918 - 2N4920\* Series

Preferred Device

## Medium-Power Plastic PNP Silicon Transistors

These medium-power, high-performance plastic devices are designed for driver circuits, switching, and amplifier applications.

### Features

- Pb-Free Package is Available\*\*
- Low Saturation Voltage –  $V_{CE(sat)} = 0.6 \text{ Vdc (Max) @ } I_C = 1.0 \text{ A}$
- Excellent Power Dissipation Due to Thermopad Construction,  $P_D = 30 \text{ W @ } T_C = 25^\circ\text{C}$
- Excellent Safe Operating Area
- Gain Specified to  $I_C = 1.0 \text{ A}$
- Complement to NPN 2N4921, 2N4922, 2N4923

### MAXIMUM RATINGS

Rating	Symbol	Value	Unit
Collector – Emitter Voltage 2N4918 2N4919 2N4920	$V_{CEO}$	40 60 80	Vdc
Collector – Base Voltage 2N4918 2N4919 2N4920	$V_{CBO}$	40 60 80	Vdc
Emitter – Base Voltage	$V_{EBO}$	5.0	Vdc
Collector Current – Continuous (Note 1)	$I_C$ (Note 2)	1.0 3.0	Adc
Base Current	$I_B$	1.0	Adc
Total Power Dissipation @ $T_A = 25^\circ\text{C}$ Derate above $25^\circ\text{C}$	$P_D$	30 0.24	W W/ $^\circ\text{C}$
Operating and Storage Junction Temperature Range	$T_J, T_{stg}$	-65 to +150	$^\circ\text{C}$

Maximum ratings are those values beyond which device damage can occur. Maximum ratings applied to the device are individual stress limit values (not normal operating conditions) and are not valid simultaneously. If these limits are exceeded, device functional operation is not implied, damage may occur and reliability may be affected.

1. The 1.0 A max  $I_C$  value is based upon JEDEC current gain requirements. The 3.0 A max value is based upon actual current-handling capability of the device (See Figure 5).
2. Indicates JEDEC Registered Data for 2N4918 Series.

### THERMAL CHARACTERISTICS (Note 3)

Characteristic	Symbol	Max	Unit
Thermal Resistance, Junction-to-Case	$\theta_{JC}$	4.16	$^\circ\text{C/W}$

3. Recommend use of thermal compound for lowest thermal resistance.

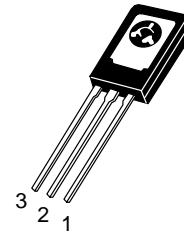
\*\*For additional information on our Pb-Free strategy and soldering details, please download the ON Semiconductor Soldering and Mounting Techniques Reference Manual, SOLDERRM/D.



ON Semiconductor®

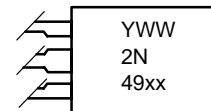
<http://onsemi.com>

**3.0 A, 40–80 V, 30 W  
GENERAL PURPOSE  
POWER TRANSISTORS**



TO-225  
CASE 077  
STYLE 1

### MARKING DIAGRAM



xx = 18, 19, 20  
Y = Year  
WW = Work Week

### ORDERING INFORMATION

See detailed ordering and shipping information in the package dimensions section on page 2 of this data sheet.

\*Preferred devices are recommended choices for future use and best overall value.

## 2N4918 – 2N4920\* Series

### ELECTRICAL CHARACTERISTICS ( $T_C = 25^\circ\text{C}$ unless otherwise noted)

Characteristic		Symbol	Min	Max	Unit
<b>OFF CHARACTERISTICS</b>					
Collector–Emitter Sustaining Voltage (Note 4) ( $I_C = 0.1\text{ Adc}$ , $I_B = 0$ )	2N4918 2N4919 2N4920	$V_{CEO(sus)}$	40 60 80	– – –	Vdc
Collector Cutoff Current ( $V_{CE} = 20\text{ Vdc}$ , $I_B = 0$ ) ( $V_{CE} = 30\text{ Vdc}$ , $I_B = 0$ ) ( $V_{CE} = 40\text{ Vdc}$ , $I_B = 0$ )	2N4918 2N4919 2N4920	$I_{CEO}$	– – –	0.5 0.5 0.5	mAdc
Collector Cutoff Current ( $V_{CE} = \text{Rated } V_{CEO}$ , $V_{BE(off)} = 1.5\text{ Vdc}$ ) ( $V_{CE} = \text{Rated } V_{CEO}$ , $V_{BE(off)} = 1.5\text{ Vdc}$ , $T_C = 125^\circ\text{C}$ )		$I_{CEX}$	– –	0.1 0.5	mAdc
Collector Cutoff Current ( $V_{CB} = \text{Rated } V_{CB}$ , $I_E = 0$ )		$I_{CBO}$	–	0.1	mAdc
Emitter Cutoff Current ( $V_{BE} = 5.0\text{ Vdc}$ , $I_C = 0$ )		$I_{EBO}$	–	1.0	mAdc

### ON CHARACTERISTICS

DC Current Gain (Note 4) ( $I_C = 50\text{ mAdc}$ , $V_{CE} = 1.0\text{ Vdc}$ ) ( $I_C = 500\text{ mAdc}$ , $V_{CE} = 1.0\text{ Vdc}$ ) ( $I_C = 1.0\text{ Adc}$ , $V_{CE} = 1.0\text{ Vdc}$ )		$h_{FE}$	40 30 10	– 150 –	–
Collector–Emitter Saturation Voltage (Note 4) ( $I_C = 1.0\text{ Adc}$ , $I_B = 0.1\text{ Adc}$ )		$V_{CE(sat)}$	–	0.6	Vdc
Base–Emitter Saturation Voltage (Note 4) ( $I_C = 1.0\text{ Adc}$ , $I_B = 0.1\text{ Adc}$ )		$V_{BE(sat)}$	–	1.3	Vdc
Base–Emitter On Voltage (Note 4) ( $I_C = 1.0\text{ Adc}$ , $V_{CE} = 1.0\text{ Vdc}$ )		$V_{BE(on)}$	–	1.3	Vdc

### SMALL–SIGNAL CHARACTERISTICS

Current–Gain – Bandwidth Product ( $I_C = 250\text{ mAdc}$ , $V_{CE} = 10\text{ Vdc}$ , $f = 1.0\text{ MHz}$ )		$f_T$	3.0	–	MHz
Output Capacitance ( $V_{CB} = 10\text{ Vdc}$ , $I_E = 0$ , $f = 100\text{ kHz}$ )		$C_{ob}$	–	100	pF
Small–Signal Current Gain ( $I_C = 250\text{ mAdc}$ , $V_{CE} = 10\text{ Vdc}$ , $f = 1.0\text{ kHz}$ )		$h_{fe}$	25	–	–

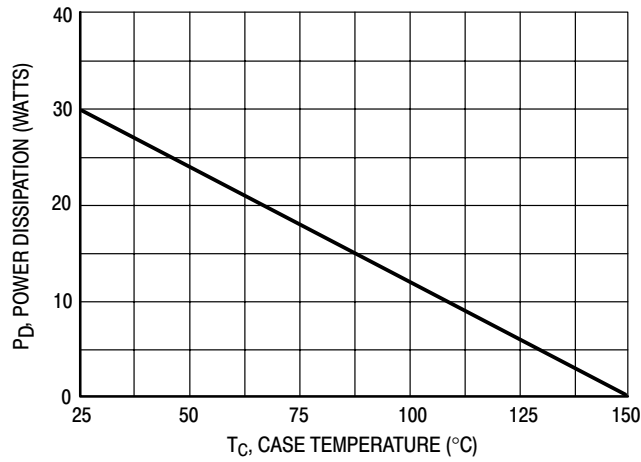
4. Pulse Test:  $PW \approx 300\ \mu\text{s}$ , Duty Cycle  $\approx 2.0\%$

### ORDERING INFORMATION

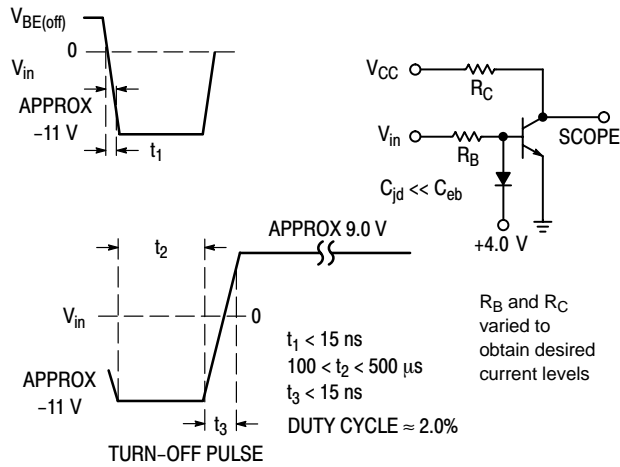
Device	Package	Shipping†
2N4918	TO–225	500 Unit / Bulk
2N4919	TO–225	500 Unit / Bulk
2N4920	TO–225	500 Unit / Bulk
2N4920G	TO–225 (Pb–Free)	500 Unit / Bulk

†For information on tape and reel specifications, including part orientation and tape sizes, please refer to our Tape and Reel Packaging Specifications Brochure, BRD8011/D.

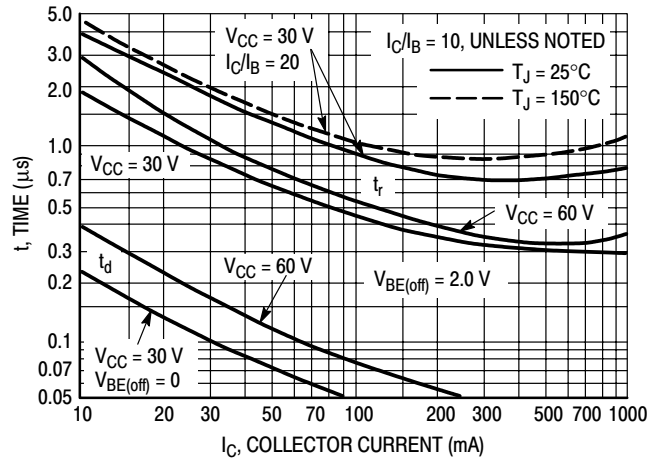
## 2N4918 – 2N4920\* Series



**Figure 1. Power Derating**

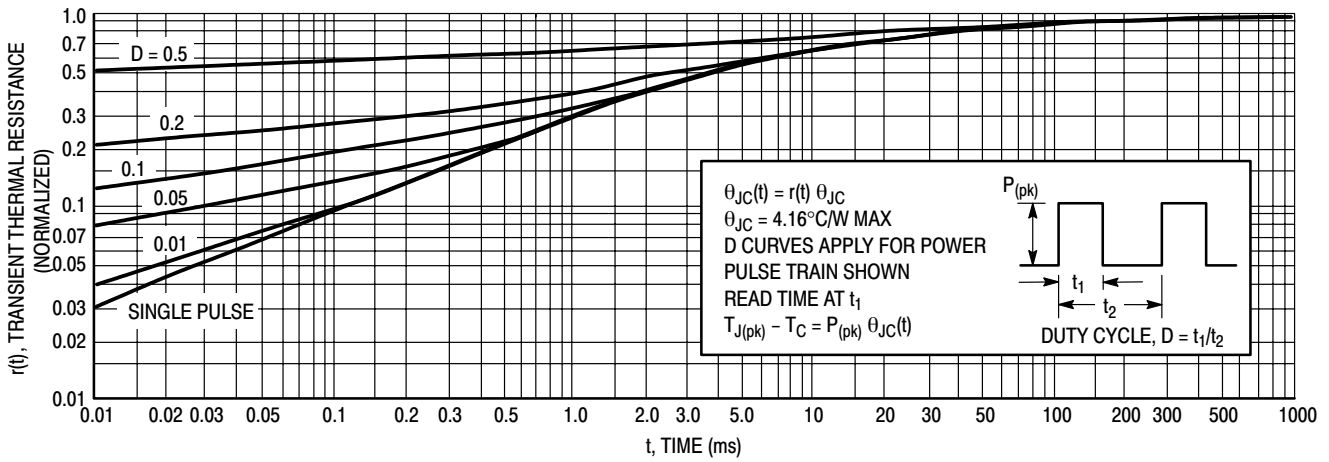


**Figure 2. Switching Time Equivalent Test Circuit**

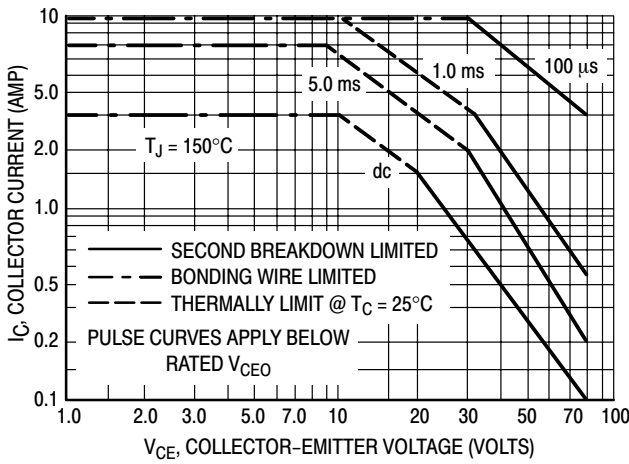


**Figure 3. Turn-On Time**

## 2N4918 – 2N4920\* Series



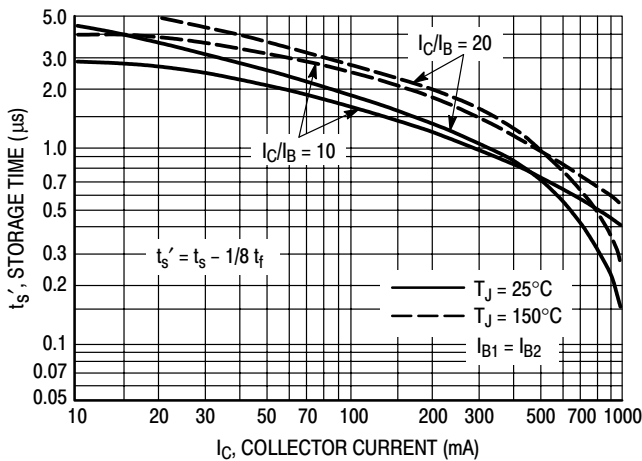
**Figure 4. Thermal Response**



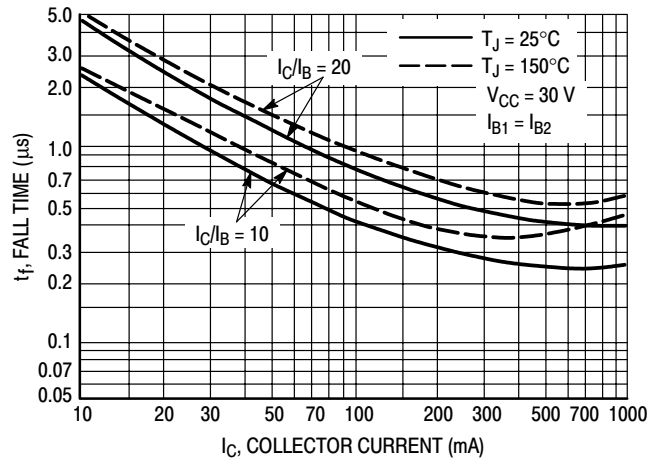
**Figure 5. Active-Region Safe Operating Area**

There are two limitations on the power handling ability of a transistor: average junction temperature and second breakdown. Safe operating area curves indicate  $I_C - V_{CE}$  operation i.e., the transistor must not be subjected to greater dissipation than the curves indicate.

The data of Figure 5 is based on  $T_{J(pk)} = 150^\circ\text{C}$ ;  $T_C$  is variable depending on conditions. Second breakdown pulse limits are valid for duty cycles to 10% provided  $T_{J(pk)} \leq 150^\circ\text{C}$ . At high case temperatures, thermal limitations will reduce the power that can be handled to values less than the limitations imposed by second breakdown.



**Figure 6. Storage Time**



**Figure 7. Fall Time**

# 2N4918 – 2N4920\* Series

## TYPICAL DC CHARACTERISTICS

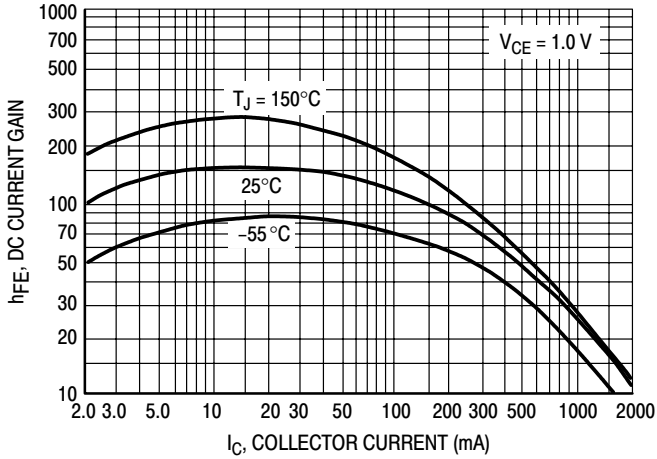


Figure 8. Current Gain

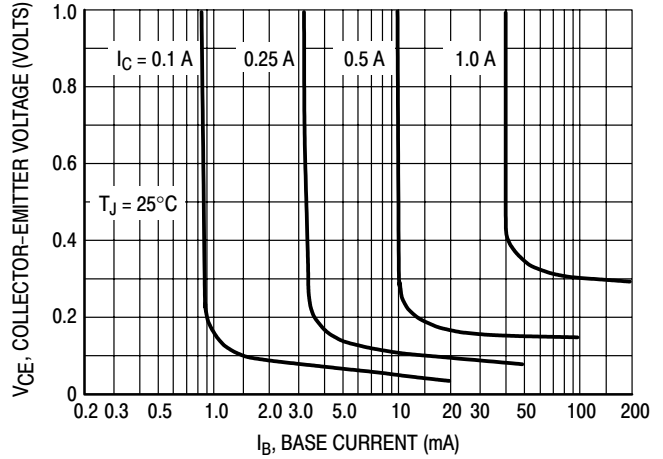


Figure 9. Collector Saturation Region

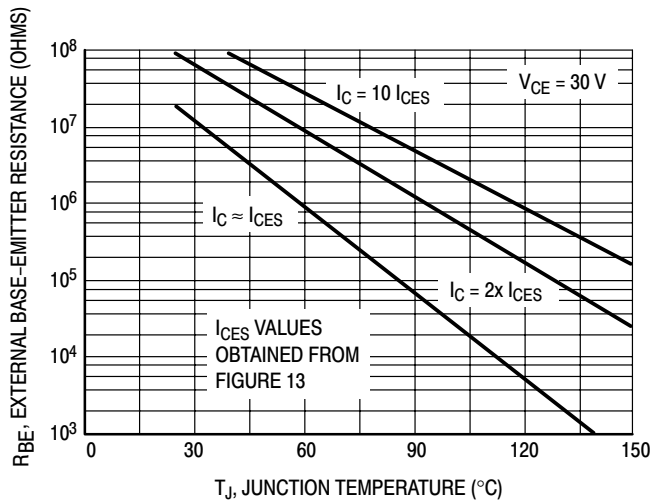


Figure 10. Effects of Base-Emitter Resistance

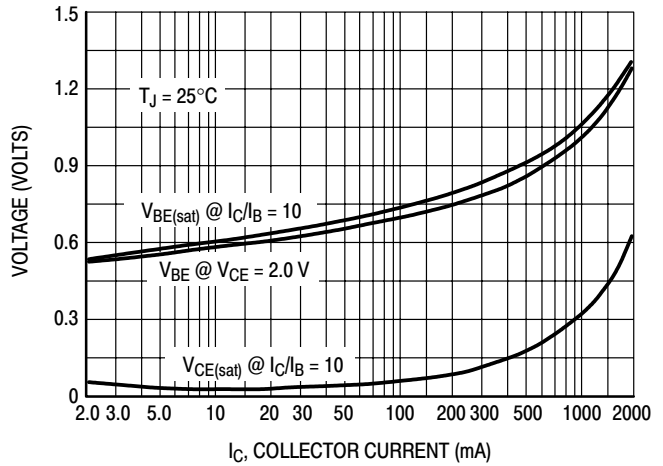


Figure 11. "On" Voltage

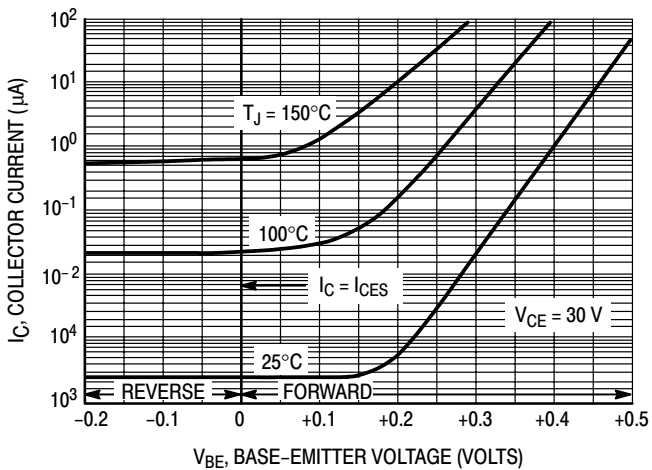


Figure 12. Collector Cut-Off Region

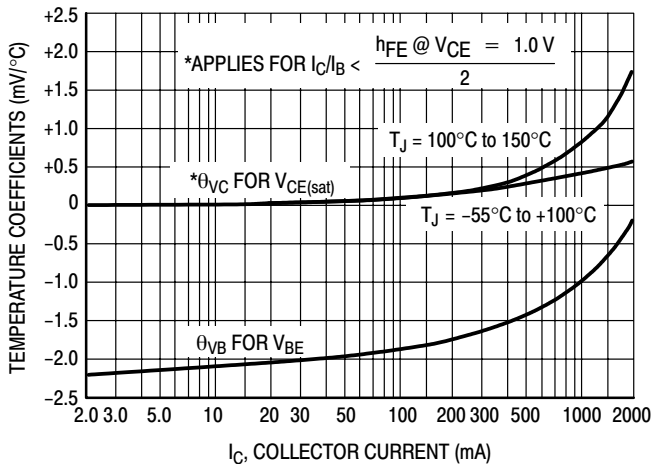
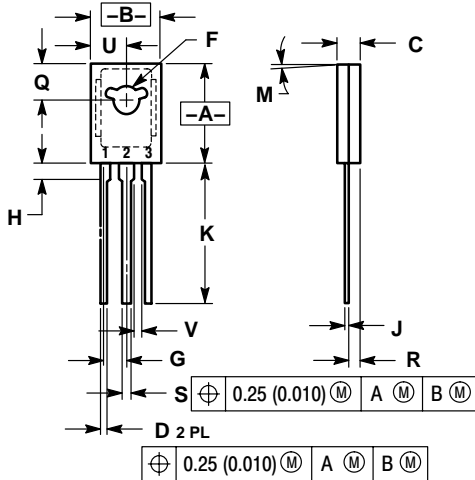


Figure 13. Temperature Coefficients

# 2N4918 – 2N4920\* Series

## PACKAGE DIMENSIONS

TO-225  
CASE 77-09  
ISSUE Z



### NOTES:

1. DIMENSIONING AND TOLERANCING PER ANSI Y14.5M, 1982.
2. CONTROLLING DIMENSION: INCH.
3. 077-01 THRU -08 OBSOLETE, NEW STANDARD 077-09.

DIM	INCHES		MILLIMETERS	
	MIN	MAX	MIN	MAX
A	0.425	0.435	10.80	11.04
B	0.295	0.305	7.50	7.74
C	0.095	0.105	2.42	2.66
D	0.020	0.026	0.51	0.66
F	0.115	0.130	2.93	3.30
G	0.094 BSC		2.39 BSC	
H	0.050	0.095	1.27	2.41
J	0.015	0.025	0.39	0.63
K	0.575	0.655	14.61	16.63
M	5° TYP		5° TYP	
Q	0.148	0.158	3.76	4.01
R	0.045	0.065	1.15	1.65
S	0.025	0.035	0.64	0.88
U	0.145	0.155	3.69	3.93
V	0.040	---	1.02	---

### STYLE 1:

- PIN 1. EMITTER
- COLLECTOR
- BASE

ON Semiconductor and are registered trademarks of Semiconductor Components Industries, LLC (SCILLC). SCILLC reserves the right to make changes without further notice to any products herein. SCILLC makes no warranty, representation or guarantee regarding the suitability of its products for any particular purpose, nor does SCILLC assume any liability arising out of the application or use of any product or circuit, and specifically disclaims any and all liability, including without limitation special, consequential or incidental damages. "Typical" parameters which may be provided in SCILLC data sheets and/or specifications can and do vary in different applications and actual performance may vary over time. All operating parameters, including "Typicals" must be validated for each customer application by customer's technical experts. SCILLC does not convey any license under its patent rights nor the rights of others. SCILLC products are not designed, intended, or authorized for use as components in systems intended for surgical implant into the body, or other applications intended to support or sustain life, or for any other application in which the failure of the SCILLC product could create a situation where personal injury or death may occur. Should Buyer purchase or use SCILLC products for any such unintended or unauthorized application, Buyer shall indemnify and hold SCILLC and its officers, employees, subsidiaries, affiliates, and distributors harmless against all claims, costs, damages, and expenses, and reasonable attorney fees arising out of, directly or indirectly, any claim of personal injury or death associated with such unintended or unauthorized use, even if such claim alleges that SCILLC was negligent regarding the design or manufacture of the part. SCILLC is an Equal Opportunity/Affirmative Action Employer. This literature is subject to all applicable copyright laws and is not for resale in any manner.

### PUBLICATION ORDERING INFORMATION

#### LITERATURE FULFILLMENT:

Literature Distribution Center for ON Semiconductor  
P.O. Box 61312, Phoenix, Arizona 85082-1312 USA  
Phone: 480-829-7710 or 800-344-3860 Toll Free USA/Canada  
Fax: 480-829-7709 or 800-344-3867 Toll Free USA/Canada  
Email: orderlit@onsemi.com

N. American Technical Support: 800-282-9855 Toll Free  
USA/Canada

Japan: ON Semiconductor, Japan Customer Focus Center  
2-9-1 Kamimeguro, Meguro-ku, Tokyo, Japan 153-0051  
Phone: 81-3-5773-3850

ON Semiconductor Website: <http://onsemi.com>

Order Literature: <http://www.onsemi.com/litorder>

For additional information, please contact your  
local Sales Representative.

Компания «Океан Электроники» предлагает заключение долгосрочных отношений при поставках импортных электронных компонентов на взаимовыгодных условиях!

Наши преимущества:

- Поставка оригинальных импортных электронных компонентов напрямую с производств Америки, Европы и Азии, а так же с крупнейших складов мира;
- Широкая линейка поставок активных и пассивных импортных электронных компонентов (более 30 млн. наименований);
- Поставка сложных, дефицитных, либо снятых с производства позиций;
- Оперативные сроки поставки под заказ (от 5 рабочих дней);
- Экспресс доставка в любую точку России;
- Помощь Конструкторского Отдела и консультации квалифицированных инженеров;
- Техническая поддержка проекта, помощь в подборе аналогов, поставка прототипов;
- Поставка электронных компонентов под контролем ВП;
- Система менеджмента качества сертифицирована по Международному стандарту ISO 9001;
- При необходимости вся продукция военного и аэрокосмического назначения проходит испытания и сертификацию в лаборатории (по согласованию с заказчиком);
- Поставка специализированных компонентов военного и аэрокосмического уровня качества (Xilinx, Altera, Analog Devices, Intersil, Interpoint, Microsemi, Actel, Aeroflex, Peregrine, VPT, Syfer, Eurofarad, Texas Instruments, MS Kennedy, Miteq, Cobham, E2V, MA-COM, Hittite, Mini-Circuits, General Dynamics и др.);

Компания «Океан Электроники» является официальным дистрибьютором и эксклюзивным представителем в России одного из крупнейших производителей разъемов военного и аэрокосмического назначения «JONHON», а так же официальным дистрибьютором и эксклюзивным представителем в России производителя высокотехнологичных и надежных решений для передачи СВЧ сигналов «FORSTAR».



## JONHON

«JONHON» (основан в 1970 г.)

Разъемы специального, военного и аэрокосмического назначения:

(Применяются в военной, авиационной, аэрокосмической, морской, железнодорожной, горно- и нефтедобывающей отраслях промышленности)

«FORSTAR» (основан в 1998 г.)

ВЧ соединители, коаксиальные кабели, кабельные сборки и микроволновые компоненты:

(Применяются в телекоммуникациях гражданского и специального назначения, в средствах связи, РЛС, а так же военной, авиационной и аэрокосмической отраслях промышленности).



Телефон: 8 (812) 309-75-97 (многоканальный)

Факс: 8 (812) 320-03-32

Электронная почта: [ocean@oceanchips.ru](mailto:ocean@oceanchips.ru)

Web: <http://oceanchips.ru/>

Адрес: 198099, г. Санкт-Петербург, ул. Калинина, д. 2, корп. 4, лит. А