



# MICROCHIP MCP413X/415X/423X/425X

## 7/8-Bit Single/Dual SPI Digital POT with Volatile Memory

### Features

- Single or Dual Resistor Network options
- Potentiometer or Rheostat configuration options
- Resistor Network Resolution
  - 7-bit: 128 Resistors (129 Steps)
  - 8-bit: 256 Resistors (257 Steps)
- $R_{AB}$  Resistances options of:
  - 5 k $\Omega$
  - 10 k $\Omega$
  - 50 k $\Omega$
  - 100 k $\Omega$
- Zero Scale to Full-Scale Wiper operation
- Low Wiper Resistance: 75 $\Omega$  (typical)
- Low Tempo:
  - Absolute (Rheostat): 50 ppm typical (0°C to 70°C)
  - Ratiometric (Potentiometer): 15 ppm typical
- SPI Serial Interface (10 MHz, modes 0,0 & 1,1)
  - High-Speed Read/Writes to wiper registers
  - SDI/SDO multiplexing (MCP41X1 only)
- Resistor Network Terminal Disconnect Feature via:
  - Shutdown pin ( $\overline{\text{SHDN}}$ )
  - Terminal Control (TCON) Register
- Brown-out reset protection (1.5V typical)
- Serial Interface Inactive current (2.5  $\mu$ A typical)
- High-Voltage Tolerant Digital Inputs: Up to 12.5V
- Supports Split Rail Applications
- Internal weak pull-up on all digital inputs
- Wide Operating Voltage:
  - 2.7V to 5.5V - Device Characteristics Specified
  - 1.8V to 5.5V - Device Operation
- Wide Bandwidth (-3 dB) Operation:
  - 2 MHz (typical) for 5.0 k $\Omega$  device
- Extended temperature range (-40°C to +125°C)

### Description

The MCP41XX and MCP42XX devices offer a wide range of product offerings using an SPI interface. This family of devices support 7-bit and 8-bit resistor networks, and Potentiometer and Rheostat pinouts.

### Package Types (top view)



# MCP413X/415X/423X/425X

## Device Block Diagram

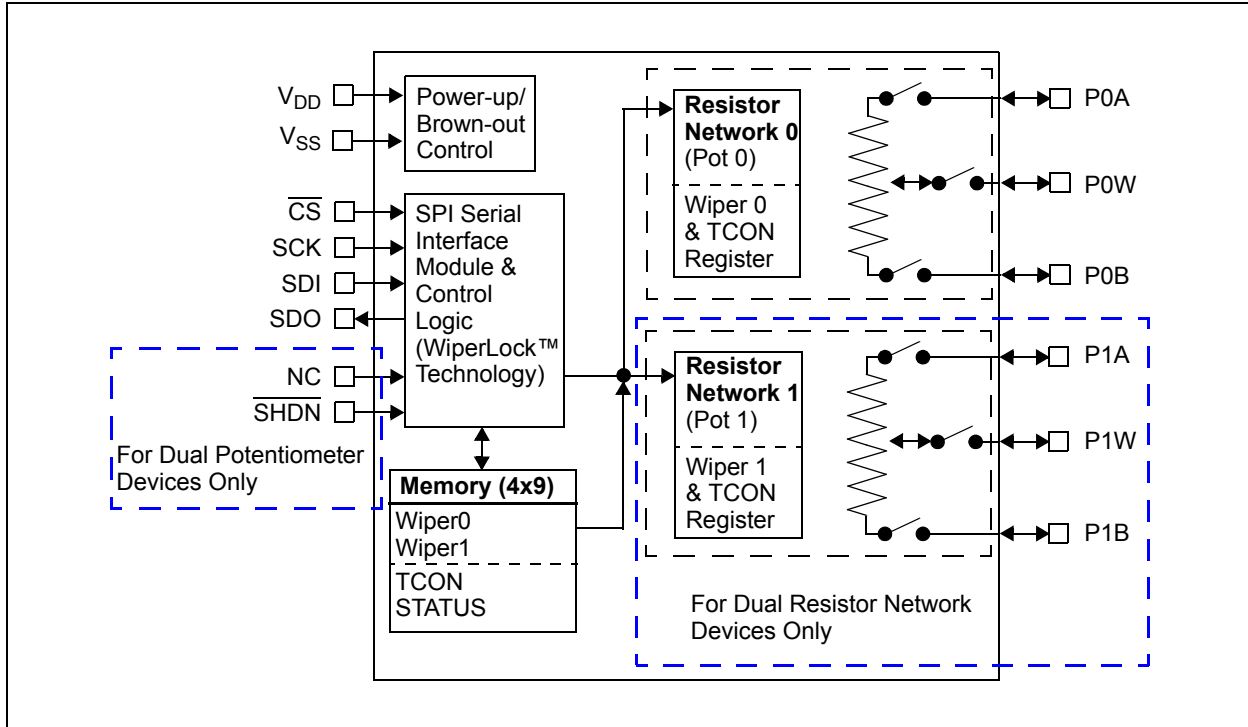

## Device Features

Device	# of POTs	Wiper Configuration	Control Interface	Memory Type	WiperLock Technology	POR Wiper Setting	Resistance (typical)		# of Steps	V <sub>DD</sub> Operating Range <sup>(2)</sup>
							R <sub>AB</sub> Options (kΩ)	Wiper - R <sub>W</sub> (Ω)		
MCP4131 <sup>(3)</sup>	1	Potentiometer <sup>(1)</sup>	SPI	RAM	No	Mid-Scale	5.0, 10.0, 50.0, 100.0	75	129	1.8V to 5.5V
MCP4132 <sup>(3)</sup>	1	Rheostat	SPI	RAM	No	Mid-Scale	5.0, 10.0, 50.0, 100.0	75	129	1.8V to 5.5V
MCP4141	1	Potentiometer <sup>(1)</sup>	SPI	EE	Yes	NV Wiper	5.0, 10.0, 50.0, 100.0	75	129	2.7V to 5.5V
MCP4142	1	Rheostat	SPI	EE	Yes	NV Wiper	5.0, 10.0, 50.0, 100.0	75	129	2.7V to 5.5V
MCP4151 <sup>(3)</sup>	1	Potentiometer <sup>(1)</sup>	SPI	RAM	No	Mid-Scale	5.0, 10.0, 50.0, 100.0	75	257	1.8V to 5.5V
MCP4152 <sup>(3)</sup>	1	Rheostat	SPI	RAM	No	Mid-Scale	5.0, 10.0, 50.0, 100.0	75	257	1.8V to 5.5V
MCP4161	1	Potentiometer <sup>(1)</sup>	SPI	EE	Yes	NV Wiper	5.0, 10.0, 50.0, 100.0	75	257	2.7V to 5.5V
MCP4162	1	Rheostat	SPI	EE	Yes	NV Wiper	5.0, 10.0, 50.0, 100.0	75	257	2.7V to 5.5V
MCP4231 <sup>(3)</sup>	2	Potentiometer <sup>(1)</sup>	SPI	RAM	No	Mid-Scale	5.0, 10.0, 50.0, 100.0	75	129	1.8V to 5.5V
MCP4232 <sup>(3)</sup>	2	Rheostat	SPI	RAM	No	Mid-Scale	5.0, 10.0, 50.0, 100.0	75	129	1.8V to 5.5V
MCP4241	2	Potentiometer <sup>(1)</sup>	SPI	EE	Yes	NV Wiper	5.0, 10.0, 50.0, 100.0	75	129	2.7V to 5.5V
MCP4242	2	Rheostat	SPI	EE	Yes	NV Wiper	5.0, 10.0, 50.0, 100.0	75	129	2.7V to 5.5V
MCP4251 <sup>(3)</sup>	2	Potentiometer <sup>(1)</sup>	SPI	RAM	No	Mid-Scale	5.0, 10.0, 50.0, 100.0	75	257	1.8V to 5.5V
MCP4252 <sup>(3)</sup>	2	Rheostat	SPI	RAM	No	Mid-Scale	5.0, 10.0, 50.0, 100.0	75	257	1.8V to 5.5V
MCP4261	2	Potentiometer <sup>(1)</sup>	SPI	EE	Yes	NV Wiper	5.0, 10.0, 50.0, 100.0	75	257	2.7V to 5.5V
MCP4262	2	Rheostat	SPI	EE	Yes	NV Wiper	5.0, 10.0, 50.0, 100.0	75	257	2.7V to 5.5V

**Note 1:** Floating either terminal (A or B) allows the device to be used as a Rheostat (variable resistor).

**Note 2:** Analog characteristics only tested from 2.7V to 5.5V unless otherwise noted.

**Note 3:** Please check Microchip web site for device release and availability.

## 1.0 ELECTRICAL CHARACTERISTICS

### Absolute Maximum Ratings †

Voltage on $V_{DD}$ with respect to $V_{SS}$ .....	-0.6V to +7.0V
Voltage on $\overline{CS}$ , SCK, SDI, SDI/SDO, and SHDN with respect to $V_{SS}$ .....	-0.6V to 12.5V
Voltage on all other pins (PxA, PxW, PxB, and SDO) with respect to $V_{SS}$ .....	-0.3V to $V_{DD} + 0.3V$
Input clamp current, $I_{IK}$ ( $V_I < 0$ , $V_I > V_{DD}$ , $V_I > V_{PP}$ ON HV pins) .....	$\pm 20$ mA
Output clamp current, $I_{OK}$ ( $V_O < 0$ or $V_O > V_{DD}$ ) .....	$\pm 20$ mA
Maximum output current sunk by any Output pin .....	25 mA
Maximum output current sourced by any Output pin .....	25 mA
Maximum current out of $V_{SS}$ pin .....	100 mA
Maximum current into $V_{DD}$ pin .....	100 mA
Maximum current into PxA, PxW & PxB pins .....	$\pm 2.5$ mA
Storage temperature .....	-65°C to +150°C
Ambient temperature with power applied .....	-40°C to +125°C
Total power dissipation ( <b>Note 1</b> ) .....	400 mW
Soldering temperature of leads (10 seconds) .....	+300°C
ESD protection on all pins .....	$\geq 4$ kV (HBM), $\geq 300V$ (MM)
Maximum Junction Temperature ( $T_J$ ) .....	+150°C

**Note 1:** Power dissipation is calculated as follows:

$$P_{dis} = V_{DD} \times \{I_{DD} - \sum I_{OH}\} + \sum \{(V_{DD} - V_{OH}) \times I_{OH}\} + \sum (V_{OI} \times I_{OL})$$

† **Notice:** Stresses above those listed under “Maximum Ratings” may cause permanent damage to the device. This is a stress rating only and functional operation of the device at those or any other conditions above those indicated in the operational listings of this specification is not implied. Exposure to maximum rating conditions for extended periods may affect device reliability.

# MCP413X/415X/423X/425X

## AC/DC CHARACTERISTICS

DC Characteristics		Standard Operating Conditions (unless otherwise specified)				
		Operating Temperature $-40^{\circ}\text{C} \leq T_A \leq +125^{\circ}\text{C}$ (extended)				
		All parameters apply across the specified operating ranges unless noted.				
		$V_{DD} = +2.7\text{V}$ to $5.5\text{V}$ , $5\text{ k}\Omega$ , $10\text{ k}\Omega$ , $50\text{ k}\Omega$ , $100\text{ k}\Omega$ devices.				
		Typical specifications represent values for $V_{DD} = 5.5\text{V}$ , $T_A = +25^{\circ}\text{C}$ .				
Parameters	Sym	Min	Typ	Max	Units	Conditions
Supply Voltage	$V_{DD}$	2.7	—	5.5	V	
		1.8	—	2.7	V	Serial Interface only.
$\overline{\text{CS}}$ , $\text{SDI}$ , $\text{SDO}$ , $\text{SCK}$ , $\text{SHDN}$ pin Voltage Range	$V_{HV}$	$V_{SS}$	—	12.5V	V	$V_{DD} \geq 4.5\text{V}$
		$V_{SS}$	—	$V_{DD} + 8.0\text{V}$	V	$V_{DD} < 4.5\text{V}$
$V_{DD}$ Start Voltage to ensure Wiper Reset	$V_{BOR}$	—	—	1.65	V	RAM retention voltage ( $V_{RAM}$ ) $< V_{BOR}$
$V_{DD}$ Rise Rate to ensure Power-on Reset	$V_{DDRR}$	(Note 9)			V/ms	
Delay after device exits the reset state ( $V_{DD} > V_{BOR}$ )	$T_{BORD}$	—	10	20	$\mu\text{s}$	
Supply Current (Note 10)	$I_{DD}$	—	—	450	$\mu\text{A}$	Serial Interface Active, $V_{DD} = 5.5\text{V}$ , $\overline{\text{CS}} = V_{IL}$ , $\text{SCK} @ 5\text{ MHz}$ , write all 0's to volatile Wiper 0 (address 0h)
		—	2.5	5	$\mu\text{A}$	Serial Interface Inactive, $\overline{\text{CS}} = V_{IH}$ , $V_{DD} = 5.5\text{V}$
		—	0.55	1	$\text{mA}$	Serial Interface Active, $V_{DD} = 5.5\text{V}$ , $\overline{\text{CS}} = V_{IHH}$ , $\text{SCK} @ 5\text{ MHz}$ , decrement volatile Wiper 0 (address 0h)

**Note 1:** Resistance is defined as the resistance between terminal A to terminal B.

**2:** INL and DNL are measured at  $V_W$  with  $V_A = V_{DD}$  and  $V_B = V_{SS}$ .

**3:** **MCP4XX1** only.

**4:** **MCP4XX2** only, includes  $V_{WZSE}$  and  $V_{WFSE}$ .

**5:** Resistor terminals A, W and B's polarity with respect to each other is not restricted.

**6:** This specification by design.

**7:** Non-linearity is affected by wiper resistance ( $R_W$ ), which changes significantly over voltage and temperature.

**8:** The **MCP4XX1** is externally connected to match the configurations of the **MCP41X2** and **MCP42X2**, and then tested.

**9:** POR/BOR is not rate dependent.

**10:** Supply current is independent of current through the resistor network.

# MCP413X/415X/423X/425X

## AC/DC CHARACTERISTICS (CONTINUED)

DC Characteristics		Standard Operating Conditions (unless otherwise specified)				
		Operating Temperature $-40^{\circ}\text{C} \leq T_A \leq +125^{\circ}\text{C}$ (extended)				
		All parameters apply across the specified operating ranges unless noted.				
		$V_{DD} = +2.7\text{V}$ to $5.5\text{V}$ , $5\text{ k}\Omega$ , $10\text{ k}\Omega$ , $50\text{ k}\Omega$ , $100\text{ k}\Omega$ devices.				
		Typical specifications represent values for $V_{DD} = 5.5\text{V}$ , $T_A = +25^{\circ}\text{C}$ .				
Parameters	Sym	Min	Typ	Max	Units	Conditions
Resistance ( $\pm 20\%$ )	$R_{AB}$	4.0	5	6.0	k $\Omega$	-502 devices ( <b>Note 1</b> )
		8.0	10	12.0	k $\Omega$	-103 devices ( <b>Note 1</b> )
		40.0	50	60.0	k $\Omega$	-503 devices ( <b>Note 1</b> )
		80.0	100	120.0	k $\Omega$	-104 devices ( <b>Note 1</b> )
Resolution	N	257			Taps	8-bit No Missing Codes
		129			Taps	7-bit No Missing Codes
Step Resistance	$R_S$	—	$R_{AB} / (256)$	—	$\Omega$	8-bit <b>Note 6</b>
		—	$R_{AB} / (128)$	—	$\Omega$	7-bit <b>Note 6</b>
Nominal Resistance Match	$ R_{AB0} - R_{AB1}  / R_{AB}$	—	0.2	1.25	%	<b>MCP42X1</b> devices only
	$ R_{BW0} - R_{BW1}  / R_{BW}$	—	0.25	1.5	%	<b>MCP42X2</b> devices only, Code = Full-Scale
Wiper Resistance ( <b>Note 3, Note 4</b> )	$R_W$	—	75	160	$\Omega$	$V_{DD} = 5.5\text{ V}$ , $I_W = 2.0\text{ mA}$ , code = 00h
		—	75	300	$\Omega$	$V_{DD} = 2.7\text{ V}$ , $I_W = 2.0\text{ mA}$ , code = 00h
Nominal Resistance Tempco	$\Delta R_{AB} / \Delta T$	—	50	—	ppm/ $^{\circ}\text{C}$	$T_A = -20^{\circ}\text{C}$ to $+70^{\circ}\text{C}$
		—	100	—	ppm/ $^{\circ}\text{C}$	$T_A = -40^{\circ}\text{C}$ to $+85^{\circ}\text{C}$
		—	150	—	ppm/ $^{\circ}\text{C}$	$T_A = -40^{\circ}\text{C}$ to $+125^{\circ}\text{C}$
Ratiometric Tempco	$\Delta V_{WB} / \Delta T$	—	15	—	ppm/ $^{\circ}\text{C}$	Code = Midscale (80h or 40h)
Resistor Terminal Input Voltage Range (Terminals A, B and W)	$V_A, V_W, V_B$	$V_{SS}$	—	$V_{DD}$	V	<b>Note 5, Note 6</b>
Maximum current through A, W or B	$I_W$	—	—	2.5	mA	<b>Note 6</b> , Worst case current through wiper when wiper is either Full-Scale or Zero Scale.
Leakage current into A, W or B	$I_{WL}$	—	100	—	nA	<b>MCP4XX1</b> $P_xA = P_xW = P_xB = V_{SS}$
		—	100	—	nA	<b>MCP4XX2</b> $P_xB = P_xW = V_{SS}$

- Note 1:** Resistance is defined as the resistance between terminal A to terminal B.
- 2:** INL and DNL are measured at  $V_W$  with  $V_A = V_{DD}$  and  $V_B = V_{SS}$ .
- 3:** **MCP4XX1** only.
- 4:** **MCP4XX2** only, includes  $V_{WZSE}$  and  $V_{WFSE}$ .
- 5:** Resistor terminals A, W and B's polarity with respect to each other is not restricted.
- 6:** This specification by design.
- 7:** Non-linearity is affected by wiper resistance ( $R_W$ ), which changes significantly over voltage and temperature.
- 8:** The **MCP4XX1** is externally connected to match the configurations of the **MCP41X2** and **MCP42X2**, and then tested.
- 9:** POR/BOR is not rate dependent.
- 10:** Supply current is independent of current through the resistor network.

# MCP413X/415X/423X/425X

## AC/DC CHARACTERISTICS (CONTINUED)

DC Characteristics		Standard Operating Conditions (unless otherwise specified) Operating Temperature $-40^{\circ}\text{C} \leq T_A \leq +125^{\circ}\text{C}$ (extended) All parameters apply across the specified operating ranges unless noted. $V_{DD} = +2.7\text{V}$ to $5.5\text{V}$ , $5\text{ k}\Omega$ , $10\text{ k}\Omega$ , $50\text{ k}\Omega$ , $100\text{ k}\Omega$ devices. Typical specifications represent values for $V_{DD} = 5.5\text{V}$ , $T_A = +25^{\circ}\text{C}$ .						
Parameters	Sym	Min	Typ	Max	Units	Conditions		
Full-Scale Error (MCP4XX1 only) (8-bit code = 100h, 7-bit code = 80h)	$V_{WFSE}$	-6.0	-0.1	—	LSb	5 k $\Omega$	8-bit	$3.0\text{V} \leq V_{DD} \leq 5.5\text{V}$
		-4.0	-0.1	—	LSb		7-bit	$3.0\text{V} \leq V_{DD} \leq 5.5\text{V}$
		-3.5	-0.1	—	LSb	10 k $\Omega$	8-bit	$3.0\text{V} \leq V_{DD} \leq 5.5\text{V}$
		-2.0	-0.1	—	LSb		7-bit	$3.0\text{V} \leq V_{DD} \leq 5.5\text{V}$
		-0.8	-0.1	—	LSb	50 k $\Omega$	8-bit	$3.0\text{V} \leq V_{DD} \leq 5.5\text{V}$
		-0.5	-0.1	—	LSb		7-bit	$3.0\text{V} \leq V_{DD} \leq 5.5\text{V}$
		-0.5	-0.1	—	LSb	100 k $\Omega$	8-bit	$3.0\text{V} \leq V_{DD} \leq 5.5\text{V}$
		-0.5	-0.1	—	LSb		7-bit	$3.0\text{V} \leq V_{DD} \leq 5.5\text{V}$
Zero-Scale Error (MCP4XX1 only) (8-bit code = 00h, 7-bit code = 00h)	$V_{WZSE}$	—	+0.1	+6.0	LSb	5 k $\Omega$	8-bit	$3.0\text{V} \leq V_{DD} \leq 5.5\text{V}$
		—	+0.1	+3.0	LSb		7-bit	$3.0\text{V} \leq V_{DD} \leq 5.5\text{V}$
		—	+0.1	+3.5	LSb	10 k $\Omega$	8-bit	$3.0\text{V} \leq V_{DD} \leq 5.5\text{V}$
		—	+0.1	+2.0	LSb		7-bit	$3.0\text{V} \leq V_{DD} \leq 5.5\text{V}$
		—	+0.1	+0.8	LSb	50 k $\Omega$	8-bit	$3.0\text{V} \leq V_{DD} \leq 5.5\text{V}$
		—	+0.1	+0.5	LSb		7-bit	$3.0\text{V} \leq V_{DD} \leq 5.5\text{V}$
		—	+0.1	+0.5	LSb	100 k $\Omega$	8-bit	$3.0\text{V} \leq V_{DD} \leq 5.5\text{V}$
		—	+0.1	+0.5	LSb		7-bit	$3.0\text{V} \leq V_{DD} \leq 5.5\text{V}$
Potentiometer Integral Non-linearity	INL	-1	$\pm 0.5$	+1	LSb	8-bit	$3.0\text{V} \leq V_{DD} \leq 5.5\text{V}$	
		-0.5	$\pm 0.25$	+0.5	LSb	7-bit	MCP4XX1 devices only (Note 2)	
Potentiometer Differential Non-linearity	DNL	-0.5	$\pm 0.25$	+0.5	LSb	8-bit	$3.0\text{V} \leq V_{DD} \leq 5.5\text{V}$	
		-0.25	$\pm 0.125$	+0.25	LSb	7-bit	MCP4XX1 devices only (Note 2)	
Bandwidth -3 dB (See Figure 2-64, load = 30 pF)	BW	—	2	—	MHz	5 k $\Omega$	8-bit	Code = 80h
		—	2	—	MHz		7-bit	Code = 40h
		—	1	—	MHz	10 k $\Omega$	8-bit	Code = 80h
		—	1	—	MHz		7-bit	Code = 40h
		—	200	—	kHz	50 k $\Omega$	8-bit	Code = 80h
		—	200	—	kHz		7-bit	Code = 40h
		—	100	—	kHz	100 k $\Omega$	8-bit	Code = 80h
		—	100	—	kHz		7-bit	Code = 40h

- Note 1:** Resistance is defined as the resistance between terminal A to terminal B.
- Note 2:** INL and DNL are measured at  $V_W$  with  $V_A = V_{DD}$  and  $V_B = V_{SS}$ .
- Note 3:** MCP4XX1 only.
- Note 4:** MCP4XX2 only, includes  $V_{WZSE}$  and  $V_{WFSE}$ .
- Note 5:** Resistor terminals A, W and B's polarity with respect to each other is not restricted.
- Note 6:** This specification by design.
- Note 7:** Non-linearity is affected by wiper resistance ( $R_W$ ), which changes significantly over voltage and temperature.
- Note 8:** The MCP4XX1 is externally connected to match the configurations of the MCP41X2 and MCP42X2, and then tested.
- Note 9:** POR/BOR is not rate dependent.
- Note 10:** Supply current is independent of current through the resistor network.

# MCP413X/415X/423X/425X

## AC/DC CHARACTERISTICS (CONTINUED)

DC Characteristics		Standard Operating Conditions (unless otherwise specified) Operating Temperature $-40^{\circ}\text{C} \leq T_A \leq +125^{\circ}\text{C}$ (extended) All parameters apply across the specified operating ranges unless noted. $V_{DD} = +2.7\text{V}$ to $5.5\text{V}$ , $5\text{ k}\Omega$ , $10\text{ k}\Omega$ , $50\text{ k}\Omega$ , $100\text{ k}\Omega$ devices. Typical specifications represent values for $V_{DD} = 5.5\text{V}$ , $T_A = +25^{\circ}\text{C}$ .							
Parameters	Sym	Min	Typ	Max	Units	Conditions			
Rheostat Integral Non-linearity <b>MCP41X1</b> (Note 4, Note 8) <b>MCP4XX2</b> devices only (Note 4)	R-INL	-1.5	$\pm 0.5$	+1.5	LSb	5 k $\Omega$	8-bit	5.5V, $I_W = 900\text{ }\mu\text{A}$	
		-8.25	+4.5	+8.25	LSb			3.0V, $I_W = 480\text{ }\mu\text{A}$ (Note 7)	
		<b>Section 2.0</b>							1.8V
		-1.125	$\pm 0.5$	+1.125	LSb	10 k $\Omega$	7-bit	5.5V, $I_W = 900\text{ }\mu\text{A}$	
		-6.0	+4.5	+6.0	LSb			3.0V, $I_W = 480\text{ }\mu\text{A}$ (Note 7)	
		<b>Section 2.0</b>							1.8V
		-1.5	$\pm 0.5$	+1.5	LSb	10 k $\Omega$	8-bit	5.5V, $I_W = 450\text{ }\mu\text{A}$	
		-5.5	+2.5	+5.5	LSb			3.0V, $I_W = 240\text{ }\mu\text{A}$ (Note 7)	
		<b>Section 2.0</b>							1.8V
		-1.125	$\pm 0.5$	+1.125	LSb	10 k $\Omega$	7-bit	5.5V, $I_W = 450\text{ }\mu\text{A}$	
		-4.0	+2.5	+4.0	LSb			3.0V, $I_W = 240\text{ }\mu\text{A}$ (Note 7)	
		<b>Section 2.0</b>							1.8V
		-1.5	$\pm 0.5$	+1.5	LSb	50 k $\Omega$	8-bit	5.5V, $I_W = 90\text{ }\mu\text{A}$	
		-2.0	+1	+2.0	LSb			3.0V, $I_W = 48\text{ }\mu\text{A}$ (Note 7)	
		<b>Section 2.0</b>							1.8V
		-1.125	$\pm 0.5$	+1.125	LSb	50 k $\Omega$	7-bit	5.5V, $I_W = 90\text{ }\mu\text{A}$	
		-1.5	+1	+1.5	LSb			3.0V, $I_W = 48\text{ }\mu\text{A}$ (Note 7)	
		<b>Section 2.0</b>							1.8V
		-1.0	$\pm 0.5$	+1.0	LSb	100 k $\Omega$	8-bit	5.5V, $I_W = 45\text{ }\mu\text{A}$	
		-1.5	+0.25	+1.5	LSb			3.0V, $I_W = 24\text{ }\mu\text{A}$ (Note 7)	
		<b>Section 2.0</b>							1.8V
		-0.8	$\pm 0.5$	+0.8	LSb	100 k $\Omega$	7-bit	5.5V, $I_W = 45\text{ }\mu\text{A}$	
		-1.125	+0.25	+1.125	LSb			3.0V, $I_W = 24\text{ }\mu\text{A}$ (Note 7)	
		<b>Section 2.0</b>							1.8V

- Note 1:** Resistance is defined as the resistance between terminal A to terminal B.
- Note 2:** INL and DNL are measured at  $V_W$  with  $V_A = V_{DD}$  and  $V_B = V_{SS}$ .
- Note 3:** **MCP4XX1** only.
- Note 4:** **MCP4XX2** only, includes  $V_{WZSE}$  and  $V_{WFSE}$ .
- Note 5:** Resistor terminals A, W and B's polarity with respect to each other is not restricted.
- Note 6:** This specification by design.
- Note 7:** Non-linearity is affected by wiper resistance ( $R_W$ ), which changes significantly over voltage and temperature.
- Note 8:** The **MCP4XX1** is externally connected to match the configurations of the **MCP41X2** and **MCP42X2**, and then tested.
- Note 9:** POR/BOR is not rate dependent.
- Note 10:** Supply current is independent of current through the resistor network.

# MCP413X/415X/423X/425X

## AC/DC CHARACTERISTICS (CONTINUED)

DC Characteristics		Standard Operating Conditions (unless otherwise specified) Operating Temperature $-40^{\circ}\text{C} \leq T_A \leq +125^{\circ}\text{C}$ (extended) All parameters apply across the specified operating ranges unless noted. $V_{DD} = +2.7\text{V}$ to $5.5\text{V}$ , $5\text{ k}\Omega$ , $10\text{ k}\Omega$ , $50\text{ k}\Omega$ , $100\text{ k}\Omega$ devices. Typical specifications represent values for $V_{DD} = 5.5\text{V}$ , $T_A = +25^{\circ}\text{C}$ .									
Parameters	Sym	Min	Typ	Max	Units	Conditions					
Rheostat Differential Non-linearity <b>MCP41X1</b> (Note 4, Note 8) <b>MCP4XX2</b> devices only (Note 4)	R-DNL	-0.5	$\pm 0.25$	+0.5	LSb	5 k $\Omega$	8-bit	5.5V, $I_W = 900\ \mu\text{A}$			
		-1.0	+0.5	+1.0	LSb			3.0V (Note 7)			
		Section 2.0									1.8V
		-0.375	$\pm 0.25$	+0.375	LSb			10 k $\Omega$	7-bit	5.5V, $I_W = 900\ \mu\text{A}$	
		-0.75	+0.5	+0.75	LSb					3.0V (Note 7)	
		Section 2.0									
		-0.5	$\pm 0.25$	+0.5	LSb	50 k $\Omega$	8-bit			5.5V, $I_W = 450\ \mu\text{A}$	
		-1.0	+0.25	+1.0	LSb					3.0V (Note 7)	
		Section 2.0									
		-0.375	$\pm 0.25$	+0.375	LSb			100 k $\Omega$	7-bit	5.5V, $I_W = 450\ \mu\text{A}$	
		-0.75	+0.5	+0.75	LSb					3.0V (Note 7)	
		Section 2.0									
		-0.5	$\pm 0.25$	+0.5	LSb	50 k $\Omega$	8-bit			5.5V, $I_W = 90\ \mu\text{A}$	
		-0.5	$\pm 0.25$	+0.5	LSb					3.0V (Note 7)	
		Section 2.0									
		-0.375	$\pm 0.25$	+0.375	LSb			100 k $\Omega$	7-bit	5.5V, $I_W = 90\ \mu\text{A}$	
		-0.375	$\pm 0.25$	+0.375	LSb					3.0V (Note 7)	
		Section 2.0									
		-0.5	$\pm 0.25$	+0.5	LSb	100 k $\Omega$	8-bit			5.5V, $I_W = 45\ \mu\text{A}$	
		-0.5	$\pm 0.25$	+0.5	LSb					3.0V (Note 7)	
Section 2.0											1.8V
-0.375	$\pm 0.25$	+0.375	LSb	100 k $\Omega$	7-bit			5.5V, $I_W = 45\ \mu\text{A}$			
-0.375	$\pm 0.25$	+0.375	LSb					3.0V (Note 7)			
Section 2.0											1.8V
Capacitance ( $P_A$ )	$C_{AW}$	—	75			—	pF	f = 1 MHz, Code = Full-Scale			
Capacitance ( $P_W$ )	$C_W$	—	120			—	pF	f = 1 MHz, Code = Full-Scale			
Capacitance ( $P_B$ )	$C_{BW}$	—	75	—	pF	f = 1 MHz, Code = Full-Scale					

- Note 1:** Resistance is defined as the resistance between terminal A to terminal B.
- Note 2:** INL and DNL are measured at  $V_W$  with  $V_A = V_{DD}$  and  $V_B = V_{SS}$ .
- Note 3:** **MCP4XX1** only.
- Note 4:** **MCP4XX2** only, includes  $V_{WZSE}$  and  $V_{WFSE}$ .
- Note 5:** Resistor terminals A, W and B's polarity with respect to each other is not restricted.
- Note 6:** This specification by design.
- Note 7:** Non-linearity is affected by wiper resistance ( $R_W$ ), which changes significantly over voltage and temperature.
- Note 8:** The **MCP4XX1** is externally connected to match the configurations of the **MCP41X2** and **MCP42X2**, and then tested.
- Note 9:** POR/BOR is not rate dependent.
- Note 10:** Supply current is independent of current through the resistor network.



# MCP413X/415X/423X/425X

## AC/DC CHARACTERISTICS (CONTINUED)

DC Characteristics		Standard Operating Conditions (unless otherwise specified)				
		Operating Temperature $-40^{\circ}\text{C} \leq T_A \leq +125^{\circ}\text{C}$ (extended)				
		All parameters apply across the specified operating ranges unless noted.				
		$V_{DD} = +2.7\text{V}$ to $5.5\text{V}$ , $5\text{ k}\Omega$ , $10\text{ k}\Omega$ , $50\text{ k}\Omega$ , $100\text{ k}\Omega$ devices.				
		Typical specifications represent values for $V_{DD} = 5.5\text{V}$ , $T_A = +25^{\circ}\text{C}$ .				
Parameters	Sym	Min	Typ	Max	Units	Conditions
<b>Digital Inputs/Outputs (CS, SDI, SDO, SCK, SHDN)</b>						
Schmitt Trigger High Input Threshold	$V_{IH}$	$0.45 V_{DD}$	—	—	V	$2.7\text{V} \leq V_{DD} \leq 5.5\text{V}$ (Allows $2.7\text{V}$ Digital $V_{DD}$ with $5\text{V}$ Analog $V_{DD}$ )
		$0.5 V_{DD}$	—	—	V	$1.8\text{V} \leq V_{DD} \leq 2.7\text{V}$
Schmitt Trigger Low Input Threshold	$V_{IL}$	—	—	$0.2V_{DD}$	V	
Hysteresis of Schmitt Trigger Inputs	$V_{HYS}$	—	$0.1V_{DD}$	—	V	
High Voltage Limit	$V_{MAX}$	—	—	$12.5^{(6)}$	V	Pin can tolerate $V_{MAX}$ or less.
Output Low Voltage (SDO)	$V_{OL}$	$V_{SS}$	—	$0.3V_{DD}$	V	$I_{OL} = 5\text{ mA}$ , $V_{DD} = 5.5\text{V}$
		$V_{SS}$	—	$0.3V_{DD}$	V	$I_{OL} = 1\text{ mA}$ , $V_{DD} = 1.8\text{V}$
Output High Voltage (SDO)	$V_{OH}$	$0.7V_{DD}$	—	$V_{DD}$	V	$I_{OH} = -2.5\text{ mA}$ , $V_{DD} = 5.5\text{V}$
		$0.7V_{DD}$	—	$V_{DD}$	V	$I_{OL} = -1\text{ mA}$ , $V_{DD} = 1.8\text{V}$
Weak Pull-up / Pull-down Current	$I_{PU}$	—	—	1.75	mA	Internal $V_{DD}$ pull-up, $V_{IH}$ pull-down, $V_{DD} = 5.5\text{V}$ , $V_{CS} = 12.5\text{V}$
		—	170	—	$\mu\text{A}$	$\overline{\text{CS}}$ pin, $V_{DD} = 5.5\text{V}$ , $V_{CS} = 3\text{V}$
CS Pull-up / Pull-down Resistance	$R_{CS}$	—	16	—	$\text{k}\Omega$	$V_{DD} = 5.5\text{V}$ , $V_{CS} = 3\text{V}$
Input Leakage Current	$I_{IL}$	-1	—	1	$\mu\text{A}$	$V_{IN} = V_{DD}$ and $V_{IN} = V_{SS}$
Pin Capacitance	$C_{IN}$ , $C_{OUT}$	—	10	—	pF	$f_C = 20\text{ MHz}$
<b>RAM (Wiper) Value</b>						
Value Range	N	0h	—	1FFh	hex	8-bit device
		0h	—	1FFh	hex	7-bit device
POR/BOR Value	N	—	80h	—	hex	8-bit device
		—	40h	—	hex	7-bit device

- Note 1:** Resistance is defined as the resistance between terminal A to terminal B.
- 2:** INL and DNL are measured at  $V_W$  with  $V_A = V_{DD}$  and  $V_B = V_{SS}$ .
- 3:** MCP4XX1 only.
- 4:** MCP4XX2 only, includes  $V_{WZSE}$  and  $V_{WFSE}$ .
- 5:** Resistor terminals A, W and B's polarity with respect to each other is not restricted.
- 6:** This specification by design.
- 7:** Non-linearity is affected by wiper resistance ( $R_W$ ), which changes significantly over voltage and temperature.
- 8:** The MCP4XX1 is externally connected to match the configurations of the MCP41X2 and MCP42X2, and then tested.
- 9:** POR/BOR is not rate dependent.
- 10:** Supply current is independent of current through the resistor network.

# MCP413X/415X/423X/425X

## AC/DC CHARACTERISTICS (CONTINUED)

DC Characteristics		Standard Operating Conditions (unless otherwise specified) Operating Temperature $-40^{\circ}\text{C} \leq T_A \leq +125^{\circ}\text{C}$ (extended) All parameters apply across the specified operating ranges unless noted. $V_{DD} = +2.7\text{V}$ to $5.5\text{V}$ , $5\text{ k}\Omega$ , $10\text{ k}\Omega$ , $50\text{ k}\Omega$ , $100\text{ k}\Omega$ devices. Typical specifications represent values for $V_{DD} = 5.5\text{V}$ , $T_A = +25^{\circ}\text{C}$ .					
Parameters	Sym	Min	Typ	Max	Units	Conditions	
<b>Power Requirements</b>							
Power Supply Sensitivity (MCP41X2 and MCP42X2 only)	PSS	—	0.0015	0.0035	%/%	8-bit	$V_{DD} = 2.7\text{V}$ to $5.5\text{V}$ , $V_A = 2.7\text{V}$ , Code = 80h
		—	0.0015	0.0035	%/%	7-bit	$V_{DD} = 2.7\text{V}$ to $5.5\text{V}$ , $V_A = 2.7\text{V}$ , Code = 40h

- Note 1:** Resistance is defined as the resistance between terminal A to terminal B.
- 2:** INL and DNL are measured at  $V_W$  with  $V_A = V_{DD}$  and  $V_B = V_{SS}$ .
- 3:** MCP4XX1 only.
- 4:** MCP4XX2 only, includes  $V_{WZSE}$  and  $V_{WFSE}$ .
- 5:** Resistor terminals A, W and B's polarity with respect to each other is not restricted.
- 6:** This specification by design.
- 7:** Non-linearity is affected by wiper resistance ( $R_W$ ), which changes significantly over voltage and temperature.
- 8:** The MCP4XX1 is externally connected to match the configurations of the MCP41X2 and MCP42X2, and then tested.
- 9:** POR/BOR is not rate dependent.
- 10:** Supply current is independent of current through the resistor network.

# MCP413X/415X/423X/425X

## 1.1 SPI Mode Timing Waveforms and Requirements



**FIGURE 1-1:** SPI Timing Waveform (Mode = 11).

**TABLE 1-1: SPI REQUIREMENTS (MODE = 11)**

#	Characteristic	Symbol	Min	Max	Units	Conditions
	SCK Input Frequency	$F_{SCK}$	—	10	MHz	$V_{DD} = 2.7V$ to $5.5V$
			—	1	MHz	$V_{DD} = 1.8V$ to $2.7V$
70	$\overline{CS}$ Active ( $V_{IL}$ or $V_{IHH}$ ) to $SCK\uparrow$ input	$T_{csA2scH}$	60	—	ns	
71	SCK input high time	$T_{scH}$	45	—	ns	$V_{DD} = 2.7V$ to $5.5V$
			500	—	ns	$V_{DD} = 1.8V$ to $2.7V$
72	SCK input low time	$T_{scL}$	45	—	ns	$V_{DD} = 2.7V$ to $5.5V$
			500	—	ns	$V_{DD} = 1.8V$ to $2.7V$
73	Setup time of SDI input to $SCK\uparrow$ edge	$T_{DlV2scH}$	10	—	ns	
74	Hold time of SDI input from $SCK\uparrow$ edge	$T_{scH2dIL}$	20	—	ns	
77	$\overline{CS}$ Inactive ( $V_{IH}$ ) to SDO output hi-impedance	$T_{csH2doZ}$	—	50	ns	<b>Note 1</b>
			—	170	ns	$V_{DD} = 1.8V$ to $2.7V$
83	$\overline{CS}$ Inactive ( $V_{IH}$ ) after $SCK\uparrow$ edge	$T_{scH2csl}$	100	—	ns	$V_{DD} = 2.7V$ to $5.5V$
			1	—	ms	$V_{DD} = 1.8V$ to $2.7V$
84	Hold time of $\overline{CS}$ Inactive ( $V_{IH}$ ) to $\overline{CS}$ Active ( $V_{IL}$ or $V_{IHH}$ )	$T_{csA2csl}$	50	—	ns	

**Note 1:** This specification by design.

# MCP413X/415X/423X/425X



**FIGURE 1-2:** SPI Timing Waveform (Mode = 00).

**TABLE 1-2: SPI REQUIREMENTS (MODE = 00)**

#	Characteristic	Symbol	Min	Max	Units	Conditions
	SCK Input Frequency	$F_{SCK}$	—	10	MHz	$V_{DD} = 2.7V$ to 5.5V
			—	1	MHz	$V_{DD} = 1.8V$ to 2.7V
70	$\overline{CS}$ Active ( $V_{IL}$ or $V_{IHH}$ ) to SCK↑ input	$T_{csA2sch}$	60	—	ns	
71	SCK input high time	$T_{sch}$	45	—	ns	$V_{DD} = 2.7V$ to 5.5V
			500	—	ns	$V_{DD} = 1.8V$ to 2.7V
72	SCK input low time	$T_{scl}$	45	—	ns	$V_{DD} = 2.7V$ to 5.5V
			500	—	ns	$V_{DD} = 1.8V$ to 2.7V
73	Setup time of SDI input to SCK↑ edge	$T_{DIv2sch}$	10	—	ns	
74	Hold time of SDI input from SCK↑ edge	$T_{sch2DiL}$	20	—	ns	
77	$\overline{CS}$ Inactive ( $V_{IH}$ ) to SDO output hi-impedance	$T_{csH2DoZ}$	—	50	ns	<b>Note 1</b>
80	SDO data output valid after SCK↓ edge	$T_{scl2DoV}$	—	70	ns	$V_{DD} = 2.7V$ to 5.5V
			—	170	ns	$V_{DD} = 1.8V$ to 2.7V
82	SDO data output valid after $\overline{CS}$ Active ( $V_{IL}$ or $V_{IHH}$ )	$T_{ssL2doV}$	—	70	ns	
83	$\overline{CS}$ Inactive ( $V_{IH}$ ) after SCK↓ edge	$T_{sch2csl}$	100	—	ns	$V_{DD} = 2.7V$ to 5.5V
			1	—	ms	$V_{DD} = 1.8V$ to 2.7V
84	Hold time of $\overline{CS}$ Inactive ( $V_{IH}$ ) to $\overline{CS}$ Active ( $V_{IL}$ or $V_{IHH}$ )	$T_{csA2csl}$	50	—	ns	

**Note 1:** This specification by design.

# MCP413X/415X/423X/425X

**TABLE 1-3: SPI REQUIREMENTS FOR SDI/SDO MULTIPLEXED (READ OPERATION ONLY)<sup>(2)</sup>**

Characteristic	Symbol	Min	Max	Units	Conditions
SCK Input Frequency	$F_{SCK}$	—	250	kHz	$V_{DD} = 2.7V$ to $5.5V$
$\overline{CS}$ Active ( $V_{IL}$ or $V_{IHH}$ ) to SCK $\uparrow$ input	$T_{csA2scH}$	60	—	ns	
SCK input high time	$T_{scH}$	1.8	—	us	
SCK input low time	$T_{scL}$	1.8	—	ns	
Setup time of SDI input to SCK $\uparrow$ edge	$T_{DI\downarrow 2scH}$	40	—	ns	
Hold time of SDI input from SCK $\uparrow$ edge	$T_{scH2DI\downarrow}$	40	—	ns	
$\overline{CS}$ Inactive ( $V_{IH}$ ) to SDO output hi-impedance	$T_{csH2doZ}$	—	50	ns	<b>Note 1</b>
SDO data output valid after SCK $\downarrow$ edge	$T_{scL2doV}$	—	1.6	us	
SDO data output valid after $\overline{CS}$ Active ( $V_{IL}$ or $V_{IHH}$ )	$T_{ssL2doV}$	—	50	ns	
$\overline{CS}$ Inactive ( $V_{IH}$ ) after SCK $\downarrow$ edge	$T_{scH2csi}$	100	—	ns	
Hold time of $\overline{CS}$ Inactive ( $V_{IH}$ ) to $\overline{CS}$ Active ( $V_{IL}$ or $V_{IHH}$ )	$T_{csA2csi}$	50	—	ns	

**Note 1:** This specification by design.

- 2:** This table is for the devices where the SPI's SDI and SDO pins are multiplexed (SDI/SDO) and a Read command is issued. This is NOT required for SDI/SDO operation with the Increment, Decrement, or Write commands. This data rate can be increased by having external pull-up resistors to increase the rising edges of each bit.

# MCP413X/415X/423X/425X

## TEMPERATURE CHARACTERISTICS

Electrical Specifications: Unless otherwise indicated, $V_{DD} = +2.7V$ to $+5.5V$ , $V_{SS} = GND$ .						
Parameters	Sym	Min	Typ	Max	Units	Conditions
<b>Temperature Ranges</b>						
Specified Temperature Range	$T_A$	-40	—	+125	°C	
Operating Temperature Range	$T_A$	-40	—	+125	°C	
Storage Temperature Range	$T_A$	-65	—	+150	°C	
<b>Thermal Package Resistances</b>						
Thermal Resistance, 8L-DFN (3x3)	$\theta_{JA}$	—	84.5	—	°C/W	
Thermal Resistance, 8L-MSOP	$\theta_{JA}$	—	211	—	°C/W	
Thermal Resistance, 8L-PDIP	$\theta_{JA}$	—	89.3	—	°C/W	
Thermal Resistance, 8L-SOIC	$\theta_{JA}$	—	149.5	—	°C/W	
Thermal Resistance, 10L-DFN (3x3)	$\theta_{JA}$	—	57	—	°C/W	
Thermal Resistance, 10L-MSOP	$\theta_{JA}$	—	211	—	°C/W	
Thermal Resistance, 14L-PDIP	$\theta_{JA}$	—	70	—	°C/W	
Thermal Resistance, 14L-SOIC	$\theta_{JA}$	—	95.3	—	°C/W	
Thermal Resistance, 14L-TSSOP	$\theta_{JA}$	—	100	—	°C/W	
Thermal Resistance, 16L-QFN	$\theta_{JA}$	—	47	—	°C/W	

## 2.0 TYPICAL PERFORMANCE CURVES

**Note:** The graphs and tables provided following this note are a statistical summary based on a limited number of samples and are provided for informational purposes only. The performance characteristics listed herein are not tested or guaranteed. In some graphs or tables, the data presented may be outside the specified operating range (e.g., outside specified power supply range) and therefore outside the warranted range.

**Note:** Unless otherwise indicated,  $T_A = +25^\circ\text{C}$ ,  $V_{DD} = 5\text{V}$ ,  $V_{SS} = 0\text{V}$ .



**FIGURE 2-1:** Device Current ( $I_{DD}$ ) vs. SPI Frequency ( $f_{SCK}$ ) and Ambient Temperature ( $V_{DD} = 2.7\text{V}$  and  $5.5\text{V}$ ).

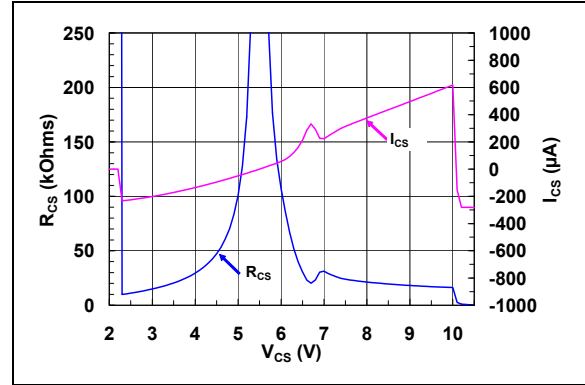

**FIGURE 2-3:**  $\overline{CS}$  Pull-up/Pull-down Resistance ( $R_{\overline{CS}}$ ) and Current ( $I_{\overline{CS}}$ ) vs.  $\overline{CS}$  Input Voltage ( $V_{\overline{CS}}$ ) ( $V_{DD} = 5.5\text{V}$ ).



**FIGURE 2-2:** Device Current ( $I_{SHDN}$ ) and  $V_{DD}$  ( $\overline{CS} = V_{DD}$ ) vs. Ambient Temperature.

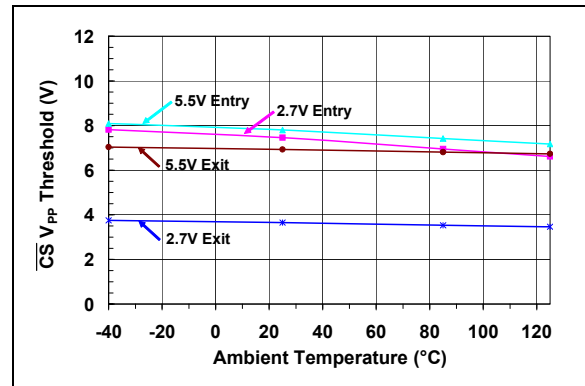

**FIGURE 2-4:**  $\overline{CS}$  High Input Entry/Exit Threshold vs. Ambient Temperature and  $V_{DD}$ .

# MCP413X/415X/423X/425X

Note: Unless otherwise indicated,  $T_A = +25^\circ\text{C}$ ,  $V_{DD} = 5\text{V}$ ,  $V_{SS} = 0\text{V}$ .



**FIGURE 2-5:** 5 kΩ Pot Mode –  $R_W$  ( $\Omega$ ), INL (LSb), DNL (LSb) vs. Wiper Setting and Ambient Temperature ( $V_{DD} = 5.5\text{V}$ ).



**FIGURE 2-8:** 5 kΩ Rheo Mode –  $R_W$  ( $\Omega$ ), INL (LSb), DNL (LSb) vs. Wiper Setting and Ambient Temperature ( $V_{DD} = 5.5\text{V}$ ).



**FIGURE 2-6:** 5 kΩ Pot Mode –  $R_W$  ( $\Omega$ ), INL (LSb), DNL (LSb) vs. Wiper Setting and Ambient Temperature ( $V_{DD} = 3.0\text{V}$ ).



**FIGURE 2-9:** 5 kΩ Rheo Mode –  $R_W$  ( $\Omega$ ), INL (LSb), DNL (LSb) vs. Wiper Setting and Ambient Temperature ( $V_{DD} = 3.0\text{V}$ ).



**Note:** Refer to AN1080 for additional information on the characteristics of the wiper resistance ( $R_W$ ) with respect to device voltage and wiper setting value.

**FIGURE 2-7:** 5 kΩ Pot Mode –  $R_W$  ( $\Omega$ ), INL (LSb), DNL (LSb) vs. Wiper Setting and Ambient Temperature ( $V_{DD} = 1.8\text{V}$ ).



**Note:** Refer to AN1080 for additional information on the characteristics of the wiper resistance ( $R_W$ ) with respect to device voltage and wiper setting value.

**FIGURE 2-10:** 5 kΩ Rheo Mode –  $R_W$  ( $\Omega$ ), INL (LSb), DNL (LSb) vs. Wiper Setting and Ambient Temperature ( $V_{DD} = 1.8\text{V}$ ).



# MCP413X/415X/423X/425X

**Note:** Unless otherwise indicated,  $T_A = +25^\circ\text{C}$ ,  $V_{DD} = 5\text{V}$ ,  $V_{SS} = 0\text{V}$ .



**FIGURE 2-11:**  $5\text{ k}\Omega$  – Nominal Resistance ( $\Omega$ ) vs. Ambient Temperature and  $V_{DD}$ .



**FIGURE 2-12:**  $5\text{ k}\Omega$  –  $R_{WB}$  ( $\Omega$ ) vs. Wiper Setting and Ambient Temperature.

# MCP413X/415X/423X/425X

Note: Unless otherwise indicated,  $T_A = +25^\circ\text{C}$ ,  $V_{DD} = 5\text{V}$ ,  $V_{SS} = 0\text{V}$ .



**FIGURE 2-13:** 5 k $\Omega$  – Low-Voltage Decrement Wiper Settling Time ( $V_{DD} = 5.5\text{V}$ ) (1  $\mu\text{s}/\text{Div}$ ).



**FIGURE 2-16:** 5 k $\Omega$  – Low-Voltage Increment Wiper Settling Time ( $V_{DD} = 5.5\text{V}$ ) (1  $\mu\text{s}/\text{Div}$ ).



**FIGURE 2-14:** 5 k $\Omega$  – Low-Voltage Decrement Wiper Settling Time ( $V_{DD} = 2.7\text{V}$ ) (1  $\mu\text{s}/\text{Div}$ ).



**FIGURE 2-17:** 5 k $\Omega$  – Low-Voltage Increment Wiper Settling Time ( $V_{DD} = 2.7\text{V}$ ) (1  $\mu\text{s}/\text{Div}$ ).



**FIGURE 2-15:** 5 k $\Omega$  – Power-Up Wiper Response Time (20 ms/Div).

# MCP413X/415X/423X/425X

**Note:** Unless otherwise indicated,  $T_A = +25^\circ\text{C}$ ,  $V_{DD} = 5\text{V}$ ,  $V_{SS} = 0\text{V}$ .



**FIGURE 2-18:** 10 k $\Omega$  Pot Mode –  $R_W$  ( $\Omega$ ), INL (LSb), DNL (LSb) vs. Wiper Setting and Ambient Temperature ( $V_{DD} = 5.5\text{V}$ ).



**FIGURE 2-21:** 10 k $\Omega$  Rheo Mode –  $R_W$  ( $\Omega$ ), INL (LSb), DNL (LSb) vs. Wiper Setting and Ambient Temperature ( $V_{DD} = 5.5\text{V}$ ).



**FIGURE 2-19:** 10 k $\Omega$  Pot Mode –  $R_W$  ( $\Omega$ ), INL (LSb), DNL (LSb) vs. Wiper Setting and Ambient Temperature ( $V_{DD} = 3.0\text{V}$ ).



**FIGURE 2-22:** 10 k $\Omega$  Rheo Mode –  $R_W$  ( $\Omega$ ), INL (LSb), DNL (LSb) vs. Wiper Setting and Ambient Temperature ( $V_{DD} = 3.0\text{V}$ ).



**Note:** Refer to AN1080 for additional information on the characteristics of the wiper resistance ( $R_W$ ) with respect to device voltage and wiper setting value.

**FIGURE 2-20:** 10 k $\Omega$  Pot Mode –  $R_W$  ( $\Omega$ ), INL (LSb), DNL (LSb) vs. Wiper Setting and Ambient Temperature ( $V_{DD} = 1.8\text{V}$ ).



**Note:** Refer to AN1080 for additional information on the characteristics of the wiper resistance ( $R_W$ ) with respect to device voltage and wiper setting value.

**FIGURE 2-23:** 10 k $\Omega$  Rheo Mode –  $R_W$  ( $\Omega$ ), INL (LSb), DNL (LSb) vs. Wiper Setting and Ambient Temperature ( $V_{DD} = 1.8\text{V}$ ).

# MCP413X/415X/423X/425X

Note: Unless otherwise indicated,  $T_A = +25^\circ\text{C}$ ,  $V_{DD} = 5\text{V}$ ,  $V_{SS} = 0\text{V}$ .



**FIGURE 2-24:**  $10\text{ k}\Omega$  – Nominal Resistance ( $\Omega$ ) vs. Ambient Temperature and  $V_{DD}$ .



**FIGURE 2-25:**  $10\text{ k}\Omega$  –  $R_{WB}$  ( $\Omega$ ) vs. Wiper Setting and Ambient Temperature.

# MCP413X/415X/423X/425X

**Note:** Unless otherwise indicated,  $T_A = +25^\circ\text{C}$ ,  $V_{DD} = 5\text{V}$ ,  $V_{SS} = 0\text{V}$ .



**FIGURE 2-26:** 10 k $\Omega$  – Low-Voltage Decrement Wiper Settling Time ( $V_{DD} = 5.5\text{V}$ ) ( $1\ \mu\text{s}/\text{Div}$ ).



**FIGURE 2-28:** 10 k $\Omega$  – Low-Voltage Increment Wiper Settling Time ( $V_{DD} = 5.5\text{V}$ ) ( $1\ \mu\text{s}/\text{Div}$ ).



**FIGURE 2-27:** 10 k $\Omega$  – Low-Voltage Decrement Wiper Settling Time ( $V_{DD} = 2.7\text{V}$ ) ( $1\ \mu\text{s}/\text{Div}$ ).



**FIGURE 2-29:** 10 k $\Omega$  – Low-Voltage Increment Wiper Settling Time ( $V_{DD} = 2.7\text{V}$ ) ( $1\ \mu\text{s}/\text{Div}$ ).

# MCP413X/415X/423X/425X

Note: Unless otherwise indicated,  $T_A = +25^\circ\text{C}$ ,  $V_{DD} = 5\text{V}$ ,  $V_{SS} = 0\text{V}$ .



**FIGURE 2-30:** 50 kΩ Pot Mode –  $R_w$  ( $\Omega$ ), INL (LSb), DNL (LSb) vs. Wiper Setting and Ambient Temperature ( $V_{DD} = 5.5\text{V}$ ).



**FIGURE 2-33:** 50 kΩ Rheo Mode –  $R_w$  ( $\Omega$ ), INL (LSb), DNL (LSb) vs. Wiper Setting and Ambient Temperature ( $V_{DD} = 5.5\text{V}$ ).



**FIGURE 2-31:** 50 kΩ Pot Mode –  $R_w$  ( $\Omega$ ), INL (LSb), DNL (LSb) vs. Wiper Setting and Ambient Temperature ( $V_{DD} = 3.0\text{V}$ ).



**FIGURE 2-34:** 50 kΩ Rheo Mode –  $R_w$  ( $\Omega$ ), INL (LSb), DNL (LSb) vs. Wiper Setting and Ambient Temperature ( $V_{DD} = 3.0\text{V}$ ).



**Note:** Refer to AN1080 for additional information on the characteristics of the wiper resistance ( $R_w$ ) with respect to device voltage and wiper setting value.

**FIGURE 2-32:** 50 kΩ Pot Mode –  $R_w$  ( $\Omega$ ), INL (LSb), DNL (LSb) vs. Wiper Setting and Ambient Temperature ( $V_{DD} = 1.8\text{V}$ ).



**Note:** Refer to AN1080 for additional information on the characteristics of the wiper resistance ( $R_w$ ) with respect to device voltage and wiper setting value.

**FIGURE 2-35:** 50 kΩ Rheo Mode –  $R_w$  ( $\Omega$ ), INL (LSb), DNL (LSb) vs. Wiper Setting and Ambient Temperature ( $V_{DD} = 1.8\text{V}$ ).

# MCP413X/415X/423X/425X

**Note:** Unless otherwise indicated,  $T_A = +25^\circ\text{C}$ ,  $V_{DD} = 5\text{V}$ ,  $V_{SS} = 0\text{V}$ .



**FIGURE 2-36:**  $50\text{ k}\Omega$  – Nominal Resistance ( $\Omega$ ) vs. Ambient Temperature and  $V_{DD}$ .



**FIGURE 2-37:**  $50\text{ k}\Omega$  –  $R_{WB}$  ( $\Omega$ ) vs. Wiper Setting and Ambient Temperature.



# MCP413X/415X/423X/425X

Note: Unless otherwise indicated,  $T_A = +25^\circ\text{C}$ ,  $V_{DD} = 5\text{V}$ ,  $V_{SS} = 0\text{V}$ .



**FIGURE 2-38:** 50 k $\Omega$  – Low-Voltage Decrement Wiper Settling Time ( $V_{DD} = 5.5\text{V}$ ) (1  $\mu\text{s}/\text{Div}$ ).



**FIGURE 2-40:** 50 k $\Omega$  – Low-Voltage Increment Wiper Settling Time ( $V_{DD} = 5.5\text{V}$ ) (1  $\mu\text{s}/\text{Div}$ ).



**FIGURE 2-39:** 50 k $\Omega$  – Low-Voltage Decrement Wiper Settling Time ( $V_{DD} = 2.7\text{V}$ ) (1  $\mu\text{s}/\text{Div}$ ).



**FIGURE 2-41:** 50 k $\Omega$  – Low-Voltage Increment Wiper Settling Time ( $V_{DD} = 2.7\text{V}$ ) (1  $\mu\text{s}/\text{Div}$ ).



# MCP413X/415X/423X/425X

**Note:** Unless otherwise indicated,  $T_A = +25^\circ\text{C}$ ,  $V_{DD} = 5\text{V}$ ,  $V_{SS} = 0\text{V}$ .



**FIGURE 2-42:** 100 k $\Omega$  Pot Mode –  $R_w$  ( $\Omega$ ), INL (LSb), DNL (LSb) vs. Wiper Setting and Ambient Temperature ( $V_{DD} = 5.5\text{V}$ ).



**FIGURE 2-45:** 100 k $\Omega$  Rheo Mode –  $R_w$  ( $\Omega$ ), INL (LSb), DNL (LSb) vs. Wiper Setting and Ambient Temperature ( $V_{DD} = 5.5\text{V}$ ).



**FIGURE 2-43:** 100 k $\Omega$  Pot Mode –  $R_w$  ( $\Omega$ ), INL (LSb), DNL (LSb) vs. Wiper Setting and Ambient Temperature ( $V_{DD} = 3.0\text{V}$ ).



**FIGURE 2-46:** 100 k $\Omega$  Rheo Mode –  $R_w$  ( $\Omega$ ), INL (LSb), DNL (LSb) vs. Wiper Setting and Ambient Temperature ( $V_{DD} = 3.0\text{V}$ ).



**Note:** Refer to AN1080 for additional information on the characteristics of the wiper resistance ( $R_w$ ) with respect to device voltage and wiper setting value.

**FIGURE 2-44:** 100 k $\Omega$  Pot Mode –  $R_w$  ( $\Omega$ ), INL (LSb), DNL (LSb) vs. Wiper Setting and Ambient Temperature ( $V_{DD} = 1.8\text{V}$ ).



**Note:** Refer to AN1080 for additional information on the characteristics of the wiper resistance ( $R_w$ ) with respect to device voltage and wiper setting value.

**FIGURE 2-47:** 100 k $\Omega$  Rheo Mode –  $R_w$  ( $\Omega$ ), INL (LSb), DNL (LSb) vs. Wiper Setting and Ambient Temperature ( $V_{DD} = 1.8\text{V}$ ).

# MCP413X/415X/423X/425X

Note: Unless otherwise indicated,  $T_A = +25^\circ\text{C}$ ,  $V_{DD} = 5\text{V}$ ,  $V_{SS} = 0\text{V}$ .

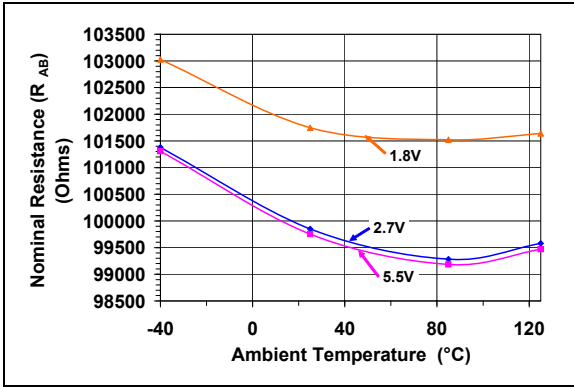

**FIGURE 2-48:**  $100\text{ k}\Omega$  – Nominal Resistance ( $\Omega$ ) vs. Ambient Temperature and  $V_{DD}$ .

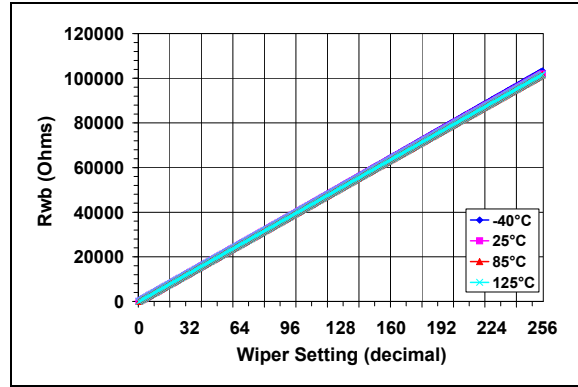

**FIGURE 2-49:**  $100\text{ k}\Omega$  –  $R_{WB}$  ( $\Omega$ ) vs. Wiper Setting and Ambient Temperature.

# MCP413X/415X/423X/425X

**Note:** Unless otherwise indicated,  $T_A = +25^\circ\text{C}$ ,  $V_{DD} = 5\text{V}$ ,  $V_{SS} = 0\text{V}$ .



**FIGURE 2-50:** 100 k $\Omega$  – Low-Voltage Decrement Wiper Settling Time ( $V_{DD} = 5.5\text{V}$ ) ( $1 \mu\text{s}/\text{Div}$ ).



**FIGURE 2-52:** 100 k $\Omega$  – Low-Voltage Increment Wiper Settling Time ( $V_{DD} = 2.7\text{V}$ ) ( $1 \mu\text{s}/\text{Div}$ ).



**FIGURE 2-51:** 100 k $\Omega$  – Low-Voltage Decrement Wiper Settling Time ( $V_{DD} = 2.7\text{V}$ ) ( $1 \mu\text{s}/\text{Div}$ ).



**FIGURE 2-53:** 100 k $\Omega$  – Power-Up Wiper Response Time ( $1 \mu\text{s}/\text{Div}$ ).

# MCP413X/415X/423X/425X

Note: Unless otherwise indicated,  $T_A = +25^\circ\text{C}$ ,  $V_{DD} = 5\text{V}$ ,  $V_{SS} = 0\text{V}$ .



**FIGURE 2-54:** Resistor Network 0 to Resistor Network 1  $R_{AB}$  ( $5\text{ k}\Omega$ ) Mismatch vs.  $V_{DD}$  and Temperature.



**FIGURE 2-56:** Resistor Network 0 to Resistor Network 1  $R_{AB}$  ( $50\text{ k}\Omega$ ) Mismatch vs.  $V_{DD}$  and Temperature.



**FIGURE 2-55:** Resistor Network 0 to Resistor Network 1  $R_{AB}$  ( $10\text{ k}\Omega$ ) Mismatch vs.  $V_{DD}$  and Temperature.



**FIGURE 2-57:** Resistor Network 0 to Resistor Network 1  $R_{AB}$  ( $100\text{ k}\Omega$ ) Mismatch vs.  $V_{DD}$  and Temperature.

# MCP413X/415X/423X/425X

**Note:** Unless otherwise indicated,  $T_A = +25^\circ\text{C}$ ,  $V_{DD} = 5\text{V}$ ,  $V_{SS} = 0\text{V}$ .



**FIGURE 2-58:**  $V_{IH}$  (SDI, SCK,  $\overline{\text{CS}}$ , and SHDN) vs.  $V_{DD}$  and Temperature.



**FIGURE 2-60:**  $I_{OH}$  (SDO) vs.  $V_{DD}$  and Temperature.



**FIGURE 2-59:**  $V_{IL}$  (SDI, SCK,  $\overline{\text{CS}}$ , and SHDN) vs.  $V_{DD}$  and Temperature.



**FIGURE 2-61:**  $I_{OL}$  (SDO) vs.  $V_{DD}$  and Temperature.

# MCP413X/415X/423X/425X

**Note:** Unless otherwise indicated,  $T_A = +25^\circ\text{C}$ ,  $V_{DD} = 5\text{V}$ ,  $V_{SS} = 0\text{V}$ .



**FIGURE 2-62:** POR/BOR Trip point vs.  $V_{DD}$  and Temperature.



**FIGURE 2-63:** SCK Input Frequency vs. Voltage and Temperature.

## 2.1 Test Circuits



**FIGURE 2-64:** -3 db Gain vs. Frequency Test.

# MCP413X/415X/423X/425X

## 3.0 PIN DESCRIPTIONS

The descriptions of the pins are listed in [Table 3-1](#). Additional descriptions of the device pins follows.

**TABLE 3-1: PINOUT DESCRIPTION FOR THE MCP413X/415X/423X/425X**

Pin					Symbol	I/O	Buffer Type	Weak Pull-up/down <sup>(2)</sup>	Standard Function
Single		Dual							
Rheo	Pot <sup>(1)</sup>	Rheo	Pot						
8L	8L	10L	14L	16L					
1	1	1	1	16	$\overline{CS}$	I	HV w/ST	“smart”	SPI Chip Select Input
2	2	2	2	1	SCK	I	HV w/ST	“smart”	SPI Clock Input
3	—	3	3	2	SDI	I	HV w/ST	“smart”	SPI Serial Data Input
—	3	—	—	—	SDI/SDO	I/O	HV w/ST	“smart”	SPI Serial Data Input/Output <b>(Note 1, Note 3)</b>
4	4	4	4	3, 4	V <sub>SS</sub>	—	P	—	Ground
—	—	5	5	5	P1B	A	Analog	No	Potentiometer 1 Terminal B
—	—	6	6	6	P1W	A	Analog	No	Potentiometer 1 Wiper Terminal
—	—	—	7	7	P1A	A	Analog	No	Potentiometer 1 Terminal A
—	5	—	8	8	P0A	A	Analog	No	Potentiometer 0 Terminal A
5	6	7	9	9	P0W	A	Analog	No	Potentiometer 0 Wiper Terminal
6	7	8	10	10	P0B	A	Analog	No	Potentiometer 0 Terminal B
—	—	—	12	13	$\overline{SHDN}$	I	HV w/ST	“smart”	Hardware Shutdown
7	—	9	13	14	SDO	O	O	No	SPI Serial Data Out
8	8	10	14	15	V <sub>DD</sub>	—	P	—	Positive Power Supply Input
—	—	—	11	11,12	NC	—	—	—	No Connection
9	9	11	—	17	EP	—	—	—	Exposed Pad <b>(Note 4)</b>

**Legend:** HV w/ST = High Voltage tolerant input (with Schmitt trigger input)  
 A = Analog pins (Potentiometer terminals) I = digital input (high Z)  
 O = digital output I/O = Input / Output  
 P = Power

- Note 1:** The 8-lead Single Potentiometer devices are pin limited so the SDO pin is multiplexed with the SDI pin (SDI/SDO pin). After the Address/Command (first 6-bits) are received, if a valid Read command has been requested, the SDO pin starts driving the requested read data onto the SDI/SDO pin.
- 2:** The pin’s “smart” pull-up shuts off while the pin is forced low. This is done to reduce the standby and shutdown current.
- 3:** The SDO is an open drain output, which uses the internal “smart” pull-up. The SDI input data rate can be at the maximum SPI frequency. the SDO output data rate will be limited by the “speed” of the pull-up, customers can increase the rate with external pull-up resistors.
- 4:** The DFN and QFN packages have a contact on the bottom of the package. This contact is conductively connected to the die substrate, and therefore should be unconnected or connected to the same ground as the device’s V<sub>SS</sub> pin.

# MCP413X/415X/423X/425X

---

## 3.1 Chip Select ( $\overline{\text{CS}}$ )

The  $\overline{\text{CS}}$  pin is the serial interface's chip select input. Forcing the  $\overline{\text{CS}}$  pin to  $V_{\text{IL}}$  enables the serial commands. Forcing the  $\overline{\text{CS}}$  pin to  $V_{\text{IHH}}$  enables the high-voltage serial commands.

## 3.2 Serial Data In (SDI)

The SDI pin is the serial interfaces Serial Data In pin. This pin is connected to the Host Controllers SDO pin.

## 3.3 Serial Data In / Serial Data Out (SDI/SDO)

On the MCP41X1 devices, pin-out limitations do not allow for individual SDI and SDO pins. On these devices, the SDI and SDO pins are multiplexed.

The MCP41X1 serial interface knows when the pin needs to change from being an input (SDI) to being an output (SDO). The Host Controller's SDO pin must be properly protected from a drive conflict.

## 3.4 Ground ( $V_{\text{SS}}$ )

The  $V_{\text{SS}}$  pin is the device ground reference.

## 3.5 Potentiometer Terminal B

The terminal B pin is connected to the internal potentiometer's terminal B.

The potentiometer's terminal B is the fixed connection to the Zero Scale wiper value of the digital potentiometer. This corresponds to a wiper value of 0x00 for both 7-bit and 8-bit devices.

The terminal B pin does not have a polarity relative to the terminal W or A pins. The terminal B pin can support both positive and negative current. The voltage on terminal B must be between  $V_{\text{SS}}$  and  $V_{\text{DD}}$ .

MCP42XX devices have two terminal B pins, one for each resistor network.

## 3.6 Potentiometer Wiper (W) Terminal

The terminal W pin is connected to the internal potentiometer's terminal W (the wiper). The wiper terminal is the adjustable terminal of the digital potentiometer. The terminal W pin does not have a polarity relative to terminals A or B pins. The terminal W pin can support both positive and negative current. The voltage on terminal W must be between  $V_{\text{SS}}$  and  $V_{\text{DD}}$ .

MCP42XX devices have two terminal W pins, one for each resistor network.

## 3.7 Potentiometer Terminal A

The terminal A pin is available on the MCP4XX1 devices, and is connected to the internal potentiometer's terminal A.

The potentiometer's terminal A is the fixed connection to the Full-Scale wiper value of the digital potentiometer. This corresponds to a wiper value of 0x100 for 8-bit devices or 0x80 for 7-bit devices.

The terminal A pin does not have a polarity relative to the terminal W or B pins. The terminal A pin can support both positive and negative current. The voltage on terminal A must be between  $V_{\text{SS}}$  and  $V_{\text{DD}}$ .

The terminal A pin is not available on the MCP4XX2 devices, and the internally terminal A signal is floating.

MCP42X1 devices have two terminal A pins, one for each resistor network.

## 3.8 Shutdown ( $\overline{\text{SHDN}}$ )

The  $\overline{\text{SHDN}}$  pin is used to force the resistor network terminals into the hardware shutdown state.

## 3.9 Serial Data Out (SDO)

The SDO pin is the serial interfaces Serial Data Out pin. This pin is connected to the Host Controllers SDI pin.

This pin allows the Host Controller to read the digital potentiometers registers, or monitor the state of the command error bit.

## 3.10 Positive Power Supply Input ( $V_{\text{DD}}$ )

The  $V_{\text{DD}}$  pin is the device's positive power supply input. The input power supply is relative to  $V_{\text{SS}}$ .

While the device  $V_{\text{DD}} < V_{\text{min}}$  (2.7V), the electrical performance of the device may not meet the data sheet specifications.

## 3.11 No Connection (NC)

These pins are not internally connected and should be either connected to  $V_{\text{DD}}$  or  $V_{\text{SS}}$  to reduce possible noise coupling.

## 3.12 Exposed Pad (EP)

This pad is conductively connected to the device's substrate. This pad should be tied to the same potential as the  $V_{\text{SS}}$  pin (or left unconnected). This pad could be used to assist as a heat sink for the device when connected to a PCB heat sink.



## 4.0 FUNCTIONAL OVERVIEW

This Data Sheet covers a family of thirty-two Digital Potentiometer and Rheostat devices that will be referred to as MCP4XXX. The MCP4XX1 devices are the Potentiometer configuration, while the MCP4XX2 devices are the Rheostat configuration.

As the [Device Block Diagram](#) shows, there are four main functional blocks. These are:

- [POR/BOR Operation](#)
- [Memory Map](#)
- [Resistor Network](#)
- [Serial Interface \(SPI\)](#)

The POR/BOR operation and the Memory Map are discussed in this section and the Resistor Network and SPI operation are described in their own sections. The [Device Commands](#) commands are discussed in [Section 7.0](#).

### 4.1 POR/BOR Operation

The Power-on Reset is the case where the device is having power applied to it from  $V_{SS}$ . The Brown-out Reset occurs when a device had power applied to it, and that power (voltage) drops below the specified range.

The devices RAM retention voltage ( $V_{RAM}$ ) is lower than the POR/BOR voltage trip point ( $V_{POR}/V_{BOR}$ ). The maximum  $V_{POR}/V_{BOR}$  voltage is less than 1.8V.

When  $V_{POR}/V_{BOR} < V_{DD} < 2.7V$ , the electrical performance may not meet the data sheet specifications. In this region, the device is capable of incrementing, decrementing, reading and writing to its volatile memory if the proper serial command is executed.

#### 4.1.1 POWER-ON RESET

When the device powers up, the device  $V_{DD}$  will cross the  $V_{POR}/V_{BOR}$  voltage. Once the  $V_{DD}$  voltage crosses the  $V_{POR}/V_{BOR}$  voltage the following happens:

- Volatile wiper register is loaded with the default wiper value
- The TCON register is loaded it's default value
- The device is capable of digital operation

#### 4.1.2 BROWN-OUT RESET

When the device powers down, the device  $V_{DD}$  will cross the  $V_{POR}/V_{BOR}$  voltage.

Once the  $V_{DD}$  voltage decreases below the  $V_{POR}/V_{BOR}$  voltage the following happens:

- Serial Interface is disabled

If the  $V_{DD}$  voltage decreases below the  $V_{RAM}$  voltage the following happens:

- Volatile wiper registers may become corrupted
- TCON register may become corrupted

As the voltage recovers above the  $V_{POR}/V_{BOR}$  voltage see [Section 4.1.1 "Power-on Reset"](#).

Serial commands not completed due to a brown-out condition may cause the memory location to become corrupted.

## 4.2 Memory Map

The device memory is 16 locations that are 9-bits wide (16x9 bits). This memory space contains four volatile locations (see [Table 4-1](#)).

**TABLE 4-1: MEMORY MAP**

Address	Function	Memory Type
00h	Volatile Wiper 0	RAM
01h	Volatile Wiper 1	RAM
02h	Reserved	—
03h	Reserved	—
04h	Volatile TCON Register	RAM
05h	Status Register	RAM
06h-0Fh	Reserved	—

#### 4.2.1 VOLATILE MEMORY (RAM)

There are four Volatile Memory locations. These are:

- Volatile Wiper 0
- Volatile Wiper 1  
(Dual Resistor Network devices only)
- Status Register
- Terminal Control (TCON) Register

The volatile memory starts functioning at the RAM retention voltage ( $V_{RAM}$ ).

# MCP413X/415X/423X/425X

## 4.2.1.1 Status (STATUS) Register

The STATUS register is placed at Address 05h.

This register contains 5 status bits. These bits show the state of the Shutdown bit. The STATUS register can be accessed via the READ commands. [Register 4-1](#) describes each STATUS register bit.

### REGISTER 4-1: STATUS REGISTER

R-1	R-1	R-1	R-1	R-0	R-x	R-x	R-x	R-x
D8:D5				RESV	RESV	RESV	SHDN	RESV
bit 7								bit 0

#### Legend:

R = Readable bit	W = Writable bit	U = Unimplemented bit, read as '0'	
-n = Value at POR	'1' = Bit is set	'0' = Bit is cleared	x = Bit is unknown

bit 8-5 **D8:D5:** Reserved. Forced to "1"

bit 4-2 **RESV:** Reserved

bit 1 **SHDN:** Hardware Shutdown pin Status bit (Refer to **Section 5.3 "Shutdown"** for further information)  
This bit indicates if the Hardware shutdown pin ( $\overline{\text{SHDN}}$ ) is low. A hardware shutdown disconnects the Terminal A and forces the wiper (Terminal W) to Terminal B (see [Figure 5-2](#)). While the device is in Hardware Shutdown (the  $\overline{\text{SHDN}}$  pin is low) the serial interface is operational so the STATUS register may be read.

1 = MCP4XXX is in the Hardware Shutdown state

0 = MCP4XXX is NOT in the Hardware Shutdown state

bit 0 **RESV:** Reserved

## 4.2.1.2 Terminal Control (TCON) Register

This register contains 8 control bits. Four bits are for Wiper 0, and four bits are for Wiper 1. [Register 4-2](#) describes each bit of the TCON register.

The state of each resistor network terminal connection is individually controlled. That is, each terminal connection (A, B and W) can be individually connected/disconnected from the resistor network. This allows the system to minimize the currents through the digital potentiometer.

The value that is written to this register will appear on the resistor network terminals when the serial command has completed.

On a POR/BOR this register is loaded with 1FFh (9-bits), for all terminals connected. The Host Controller needs to detect the POR/BOR event and then update the Volatile TCON register value.

# MCP413X/415X/423X/425X

## REGISTER 4-2: TCON BITS (1, 2)

R-1	R/W-1	R/W-1	R/W-1	R/W-1	R/W-1	R/W-1	R/W-1	R/W-1
D8	R1HW	R1A	R1W	R1B	R0HW	R0A	R0W	R0B
bit 8								bit 0

### Legend:

R = Readable bit      W = Writable bit      U = Unimplemented bit, read as '0'  
 -n = Value at POR      '1' = Bit is set      '0' = Bit is cleared      x = Bit is unknown

- bit 8      **D8:** Reserved. Forced to "1"
- bit 7      **R1HW:** Resistor 1 Hardware Configuration Control bit  
 This bit forces Resistor 1 into the "shutdown" configuration of the Hardware pin  
 1 = Resistor 1 is NOT forced to the hardware pin "shutdown" configuration  
 0 = Resistor 1 is forced to the hardware pin "shutdown" configuration
- bit 6      **R1A:** Resistor 1 Terminal A (P1A pin) Connect Control bit  
 This bit connects/disconnects the Resistor 1 Terminal A to the Resistor 1 Network  
 1 = P1A pin is connected to the Resistor 1 Network  
 0 = P1A pin is disconnected from the Resistor 1 Network
- bit 5      **R1W:** Resistor 1 Wiper (P1W pin) Connect Control bit  
 This bit connects/disconnects the Resistor 1 Wiper to the Resistor 1 Network  
 1 = P1W pin is connected to the Resistor 1 Network  
 0 = P1W pin is disconnected from the Resistor 1 Network
- bit 4      **R1B:** Resistor 1 Terminal B (P1B pin) Connect Control bit  
 This bit connects/disconnects the Resistor 1 Terminal B to the Resistor 1 Network  
 1 = P1B pin is connected to the Resistor 1 Network  
 0 = P1B pin is disconnected from the Resistor 1 Network
- bit 3      **R0HW:** Resistor 0 Hardware Configuration Control bit  
 This bit forces Resistor 0 into the "shutdown" configuration of the Hardware pin  
 1 = Resistor 0 is NOT forced to the hardware pin "shutdown" configuration  
 0 = Resistor 0 is forced to the hardware pin "shutdown" configuration
- bit 2      **R0A:** Resistor 0 Terminal A (P0A pin) Connect Control bit  
 This bit connects/disconnects the Resistor 0 Terminal A to the Resistor 0 Network  
 1 = P0A pin is connected to the Resistor 0 Network  
 0 = P0A pin is disconnected from the Resistor 0 Network
- bit 1      **R0W:** Resistor 0 Wiper (P0W pin) Connect Control bit  
 This bit connects/disconnects the Resistor 0 Wiper to the Resistor 0 Network  
 1 = P0W pin is connected to the Resistor 0 Network  
 0 = P0W pin is disconnected from the Resistor 0 Network
- bit 0      **R0B:** Resistor 0 Terminal B (P0B pin) Connect Control bit  
 This bit connects/disconnects the Resistor 0 Terminal B to the Resistor 0 Network  
 1 = P0B pin is connected to the Resistor 0 Network  
 0 = P0B pin is disconnected from the Resistor 0 Network

**Note 1:** The hardware  $\overline{\text{SHDN}}$  pin (when active) overrides the state of these bits. When the  $\overline{\text{SHDN}}$  pin returns to the inactive state, the TCON register will control the state of the terminals. The  $\overline{\text{SHDN}}$  pin does not modify the state of the TCON bits.

**2:** These bits do not affect the wiper register values.

## 5.0 RESISTOR NETWORK

The Resistor Network has either 7-bit or 8-bit resolution. Each Resistor Network allows zero scale to full-scale connections. Figure 5-1 shows a block diagram for the resistive network of a device.

The Resistor Network is made up of several parts. These include:

- Resistor Ladder
- Wiper
- Shutdown (Terminal Connections)

Devices have either one or two resistor networks. These are referred to as Pot 0 and Pot 1.



**FIGURE 5-1:** Resistor Block Diagram.

## 5.1 Resistor Ladder Module

The resistor ladder is a series of equal value resistors ( $R_S$ ) with a connection point (tap) between the two resistors. The total number of resistors in the series (ladder) determines the  $R_{AB}$  resistance (see Figure 5-1). The end points of the resistor ladder are connected to analog switches which are connected to the device Terminal A and Terminal B pins. The  $R_{AB}$  (and  $R_S$ ) resistance has small variations over voltage and temperature.

For an 8-bit device, there are 256 resistors in a string between terminal A and terminal B. The wiper can be set to tap onto any of these 256 resistors thus providing 257 possible settings (including terminal A and terminal B).

For a 7-bit device, there are 128 resistors in a string between terminal A and terminal B. The wiper can be set to tap onto any of these 128 resistors thus providing 129 possible settings (including terminal A and terminal B).

Equation 5-1 shows the calculation for the step resistance.

### EQUATION 5-1: $R_S$ CALCULATION

$R_S = \frac{R_{AB}}{(256)}$	8-bit Device
-----	
$R_S = \frac{R_{AB}}{(128)}$	7-bit Device

# MCP413X/415X/423X/425X

## 5.2 Wiper

Each tap point (between the  $R_S$  resistors) is a connection point for an analog switch. The opposite side of the analog switch is connected to a common signal which is connected to the Terminal W (Wiper) pin.

A value in the volatile wiper register selects which analog switch to close, connecting the W terminal to the selected node of the resistor ladder.

The wiper can connect directly to Terminal B or to Terminal A. A zero-scale connections, connects the Terminal W (wiper) to Terminal B (wiper setting of 000h). A full-scale connections, connects the Terminal W (wiper) to Terminal A (wiper setting of 100h or 80h). In these configurations the only resistance between the Terminal W and the other Terminal (A or B) is that of the analog switches.

A wiper setting value greater than full-scale (wiper setting of 100h for 8-bit device or 80h for 7-bit devices) will also be a Full-Scale setting (Terminal W (wiper) connected to Terminal A). [Table 5-1](#) illustrates the full wiper setting map.

[Equation 5-2](#) illustrates the calculation used to determine the resistance between the wiper and terminal B.

### EQUATION 5-2: $R_{WB}$ CALCULATION

$R_{WB} = \frac{R_{AB}N}{(256)} + R_W \quad \text{8-bit Device}$ <p style="text-align: center;">N = 0 to 256 (decimal)</p> <hr style="border-top: 1px dashed black;"/>
$R_{WB} = \frac{R_{AB}N}{(128)} + R_W \quad \text{7-bit Device}$ <p style="text-align: center;">N = 0 to 128 (decimal)</p>

**TABLE 5-1: VOLATILE WIPER VALUE VS. WIPER POSITION MAP**

Wiper Setting		Properties
7-bit Pot	8-bit Pot	
3FFh 081h	3FFh 101h	Reserved (Full-Scale (W = A)), Increment and Decrement commands ignored
080h	100h	Full-Scale (W = A), Increment commands ignored
07Fh 041h	0FFh 081	W = N
040h	080h	W = N (Mid-Scale)
03Fh 001h	07Fh 001	W = N
000h	000h	Zero Scale (W = B) Decrement command ignored

A POR/BOR event will load the Volatile Wiper register value with the default value. [Table 5-2](#) shows the default values offered. Custom POR/BOR options are available. Contact the local Microchip Sales Office.

**TABLE 5-2: DEFAULT FACTORY SETTINGS SELECTION**

Resistance Code	Typical $R_{AB}$ Value	Default POR Wiper Setting	Wiper Code	
			8-bit	7-bit
-502	5.0 k $\Omega$	Mid-scale	80h	40h
-103	10.0 k $\Omega$	Mid-scale	80h	40h
-503	50.0 k $\Omega$	Mid-scale	80h	40h
-104	100.0 k $\Omega$	Mid-scale	80h	40h

## 5.3 Shutdown

Shutdown is used to minimize the device's current consumption. The MCP4XXX has two methods to achieve this. These are:

- **Hardware Shutdown Pin (SHDN)**
- **Terminal Control Register (TCON)**

The Hardware Shutdown pin is backwards compatible with the MCP42XXX devices.

### 5.3.1 HARDWARE SHUTDOWN PIN (SHDN)

The  $\overline{\text{SHDN}}$  pin is available on the dual potentiometer devices. When the  $\overline{\text{SHDN}}$  pin is forced active ( $V_{IL}$ ):

- The P0A and P1A terminals are disconnected
- The P0W and P1W terminals are simultaneously connect to the P0B and P1B terminals, respectively (see [Figure 5-2](#))
- The Serial Interface is NOT disabled, and all Serial Interface activity is executed

The Hardware Shutdown pin mode does NOT corrupt the values in the Volatile Wiper Registers nor the TCON register. When the Shutdown mode is exited ( $\overline{\text{SHDN}}$  pin is inactive ( $V_{IH}$ ):

- The device returns to the Wiper setting specified by the Volatile Wiper value
- The TCON register bits return to controlling the terminal connection state



**FIGURE 5-2:** Hardware Shutdown Resistor Network Configuration.

### 5.3.2 TERMINAL CONTROL REGISTER (TCON)

The Terminal Control (TCON) register is a volatile register used to configure the connection of each resistor network terminal pin (A, B, and W) to the Resistor Network. This register is shown in [Register 4-2](#).

The RxHW bits forces the selected resistor network into the same state as the  $\overline{\text{SHDN}}$  pin. Alternate low-power configurations may be achieved with the RxA, RxW, and RxB bits.

**Note:** When the RxHW bit forces the resistor network into the hardware  $\overline{\text{SHDN}}$  state, the state of the TCON register RxA, RxW, and RxB bits is overridden (ignored). When the state of the RxHW bit no longer forces the resistor network into the hardware  $\overline{\text{SHDN}}$  state, the TCON register RxA, RxW, and RxB bits return to controlling the terminal connection state. In other words, the RxHW bit does not corrupt the state of the RxA, RxW, and RxB bits.

### 5.3.3 INTERACTION OF $\overline{\text{SHDN}}$ PIN AND TCON REGISTER

[Figure 5-3](#) shows how the  $\overline{\text{SHDN}}$  pin signal and the RxHW bit signal interact to control the hardware shutdown of each resistor network (independently). Using the TCON bits allows each resistor network (Pot 0 and Pot 1) to be individually “shutdown” while the hardware pin forces both resistor networks to be “shutdown” at the same time.



**FIGURE 5-3:** RxHW bit and  $\overline{\text{SHDN}}$  pin Interaction.

# MCP413X/415X/423X/425X

---

NOTES:



# MCP413X/415X/423X/425X

## 6.0 SERIAL INTERFACE (SPI)

The MCP4XXX devices support the SPI serial protocol. This SPI operates in the slave mode (does not generate the serial clock).

The SPI interface uses up to four pins. These are:

- $\overline{\text{CS}}$  - Chip Select
- SCK - Serial Clock
- SDI - Serial Data In
- SDO - Serial Data Out

Typical SPI Interfaces are shown in Figure 6-1. In the SPI interface, The Master's Output pin is connected to the Slave's Input pin and the Master's Input pin is connected to the Slave's Output pin.

The MCP4XXX SPI's module supports two (of the four) standard SPI modes. These are Mode 0, 0 and 1, 1. The SPI mode is determined by the state of the SCK pin ( $V_{IH}$  or  $V_{IL}$ ) on the when the CS pin transitions from inactive ( $V_{IH}$ ) to active ( $V_{IL}$  or  $V_{IHH}$ ).

All SPI interface signals are high-voltage tolerant.



FIGURE 6-1: Typical SPI Interface Block Diagram.

# MCP413X/415X/423X/425X

## 6.1 SDI, SDO, SCK, and $\overline{\text{CS}}$ Operation

The operation of the four SPI interface pins are discussed in this section. These pins are:

- SDI (Serial Data In)
- SDO (Serial Data Out)
- SCK (Serial Clock)
- $\overline{\text{CS}}$  (Chip Select)

The serial interface works on either 8-bit or 16-bit boundaries depending on the selected command. The Chip Select ( $\overline{\text{CS}}$ ) pin frames the SPI commands.

### 6.1.1 SERIAL DATA IN (SDI)

The Serial Data In (SDI) signal is the data signal into the device. The value on this pin is latched on the rising edge of the SCK signal.

### 6.1.2 SERIAL DATA OUT (SDO)

The Serial Data Out (SDO) signal is the data signal out of the device. The value on this pin is driven on the falling edge of the SCK signal.

Once the  $\overline{\text{CS}}$  pin is forced to the active level ( $V_{\text{IL}}$  or  $V_{\text{IHH}}$ ), the SDO pin will be driven. The state of the SDO pin is determined by the serial bit's position in the command, the command selected, and if there is a command error state (CMDERR).

### 6.1.3 SDI/SDO

**Note:** MCP41X1 Devices Only .

For device packages that do not have enough pins for both an SDI and SDO pin, the SDI and SDO functionality is multiplexed onto a single I/O pin called SDI/SDO.

The SDO will only be driven for the command error bit (CMDERR) and during the data bits of a read command (after the memory address and command has been received).

#### 6.1.3.1 SDI/SDO Operation

Figure 6-2 shows a block diagram of the SDI/SDO pin. The SDI signal has an internal "smart" pull-up. The value of this pull-up determines the frequency that data can be read from the device. An external pull-up can be added to the SDI/SDO pin to improve the rise time and therefore improve the frequency that data can be read.

**Note:** To support the High voltage requirement of the SDI function, the SDO function is an open drain output.

Data written on the SDI/SDO pin can be at the maximum SPI frequency.

**Note:** Care must be take to ensure that a Drive conflict does not exist between the Host Controllers SDO pin (or software SDI/SDO pin) and the MCP41x1 SDI/SDO pin (see Figure 6-1).

On the falling edge of the SCK pin during the C0 bit (see Figure 7-1), the SDI/SDO pin will start outputting the SDO value. The SDO signal overrides the control of the smart pull-up, such that whenever the SDI/SDO pin is outputting data, the smart pull-up is enabled.

The SDI/SDO pin will change from an input (SDI) to an output (SDO) after the state machine has received the Address and Command bits of the Command Byte. If the command is a Read command, then the SDI/SDO pin will remain an output for the remainder of the command. For any other command, the SDI/SDO pin returns to an input.



**FIGURE 6-2:** Serial I/O Mux Block Diagram.

# MCP413X/415X/423X/425X

## 6.1.4 SERIAL CLOCK (SCK) (SPI FREQUENCY OF OPERATION)

The SPI interface is specified to operate up to 10 MHz. The actual clock rate depends on the configuration of the system and the serial command used. Table 6-1 shows the SCK frequency for different configurations.

**TABLE 6-1: SCK FREQUENCY**

Memory Type Access		Command	
		Read	Write, Increment, Decrement
Volatile Memory	SDI, SDO	10 MHz	10 MHz
	SDI/SDO <sup>(1)</sup>	250 kHz <sup>(2)</sup>	10 MHz

**Note 1:** MCP41X1 devices only.

**2:** This is the maximum clock frequency without an external pull-up resistor.

## 6.1.5 THE $\overline{\text{CS}}$ SIGNAL

The Chip Select ( $\overline{\text{CS}}$ ) signal is used to select the device and frame a command sequence. To start a command, or sequence of commands, the  $\overline{\text{CS}}$  signal must transition from the inactive state ( $V_{IH}$ ) to an active state ( $V_{IL}$  or  $V_{IHH}$ ).

After the  $\overline{\text{CS}}$  signal has gone active, the SDO pin is driven and the clock bit counter is reset.

**Note:** There is a required delay after the  $\overline{\text{CS}}$  pin goes active to the 1st edge of the SCK pin.

If an error condition occurs for an SPI command, then the Command byte's Command Error (CMDERR) bit (on the SDO pin) will be driven low ( $V_{IL}$ ). To exit the error condition, the user must take the  $\overline{\text{CS}}$  pin to the  $V_{IH}$  level.

When the  $\overline{\text{CS}}$  pin returns to the inactive state ( $V_{IH}$ ) the SPI module resets (including the address pointer). While the  $\overline{\text{CS}}$  pin is in the inactive state ( $V_{IH}$ ), the serial interface is ignored. This allows the Host Controller to interface to other SPI devices using the same SDI, SDO, and SCK signals.

The  $\overline{\text{CS}}$  pin has an internal pull-up resistor. The resistor is disabled when the voltage on the  $\overline{\text{CS}}$  pin is at the  $V_{IL}$  level. This means that when the  $\overline{\text{CS}}$  pin is not driven, the internal pull-up resistor will pull this signal to the  $V_{IH}$  level. When the  $\overline{\text{CS}}$  pin is driven low ( $V_{IL}$ ), the resistance becomes very large to reduce the device current consumption.

The high voltage capability of the  $\overline{\text{CS}}$  pin allows MCP413X/415X/423X/425X devices to be used in systems previously designed for the MCP414X/416X/424X/426X devices.

# MCP413X/415X/423X/425X

## 6.2 The SPI Modes

The SPI module supports two (of the four) standard SPI modes. These are Mode 0,0 and 1,1. The mode is determined by the state of the SDI pin on the rising edge of the 1st clock bit (of the 8-bit byte).

### 6.2.1 MODE 0,0

In **Mode 0,0**: SCK idle state = low ( $V_{IL}$ ), data is clocked in on the SDI pin on the rising edge of SCK and clocked out on the SDO pin on the falling edge of SCK.

### 6.2.2 MODE 1,1

In **Mode 1,1**: SCK idle state = high ( $V_{IH}$ ), data is clocked in on the SDI pin on the rising edge of SCK and clocked out on the SDO pin on the falling edge of SCK.

## 6.3 SPI Waveforms

Figure 6-3 through Figure 6-8 show the different SPI command waveforms. Figure 6-3 and Figure 6-4 are read and write commands. Figure 6-5 and Figure 6-6 are read commands when the SDI and SDO pins are multiplexed on the same pin (SDI/SDO). Figure 6-7 and Figure 6-8 are increment and decrement commands.



**FIGURE 6-3:** 16-Bit Commands (Write, Read) - SPI Waveform (Mode 1,1).



**FIGURE 6-4:** 16-Bit Commands (Write, Read) - SPI Waveform (Mode 0,0).

# MCP413X/415X/423X/425X



**FIGURE 6-5:** 16-Bit Read Command for Devices with SDI/SDO multiplexed - SPI Waveform (Mode 1,1).



**FIGURE 6-6:** 16-Bit Read Command for Devices with SDI/SDO multiplexed - SPI Waveform (Mode 0,0).

# MCP413X/415X/423X/425X



**FIGURE 6-7:** 8-Bit Commands (Increment, Decrement, Modify - SPI Waveform with PIC MCU (Mode 1,1).



**FIGURE 6-8:** 8-Bit Commands (Increment, Decrement, Modify - SPI Waveform with PIC MCU (Mode 0,0).

# MCP413X/415X/423X/425X

## 7.0 DEVICE COMMANDS

The MCP4XXX's SPI command format supports 16 memory address locations and four commands. Each command has two modes. These are:

- Normal Serial Commands
- High-Voltage Serial Commands

Normal serial commands are those where the  $\overline{CS}$  pin is driven to  $V_{IL}$ . High Voltage Serial Commands,  $\overline{CS}$  pin is driven to  $V_{IH}$ , for compatibility with systems that also support the MCP414X/416X/424X/426X devices. High Voltage Serial Commands operate identically to their corresponding Normal Serial Command. In each mode, there are four possible commands. These commands are shown in Table 7-1.

The 8-bit commands (**Increment Wiper** and **Decrement Wiper** commands) contain a Command Byte, see Figure 7-1, while 16-bit commands (**Read Data** and **Write Data** commands) contain a Command Byte and a Data Byte. The Command Byte contains two data bits, see Figure 7-1.

Table 7-2 shows the supported commands for each memory location and the corresponding values on the SDI and SDO pins.

Table 7-3 shows an overview of all the SPI commands and their interaction with other device features.

## 7.1 Command Byte

The Command Byte has three fields, the Address, the Command, and 2 Data bits, see Figure 7-1. Currently only one of the data bits is defined (D8). This is for the Write command.

The device memory is accessed when the master sends a proper Command Byte to select the desired operation. The memory location getting accessed is contained in the Command Byte's AD3:AD0 bits. The action desired is contained in the Command Byte's C1:C0 bits, see Table 7-1. C1:C0 determines if the desired memory location will be read, written, Incremented (wiper setting +1) or Decremented (wiper setting -1). The Increment and Decrement commands are only valid on the volatile wiper registers.

As the Command Byte is being loaded into the device (on the SDI pin), the device's SDO pin is driving. The SDO pin will output high bits for the first six bits of that command. On the 7th bit, the SDO pin will output the CMDERR bit state (see Section 7.3 "Error Condition"). The 8th bit state depends on the the command selected.

TABLE 7-1: COMMAND BIT OVERVIEW

C1:C0 Bit States	Command	# of Bits
11	Read Data	16-Bits
00	Write Data	16-Bits
01	Increment	8-Bits
10	Decrement	8-Bits



FIGURE 7-1: General SPI Command Formats.

# MCP413X/415X/423X/425X

**TABLE 7-2: MEMORY MAP AND THE SUPPORTED COMMANDS**

Address		Command	Data (10-bits) <sup>(1)</sup>	SPI String (Binary)	
Value	Function			MOSI (SDI pin)	MISO (SDO pin) <sup>(2)</sup>
00h	Volatile Wiper 0	Write Data	nn nnnn nnnn	0000 00nn nnnn nnnn	1111 1111 1111 1111
		Read Data	nn nnnn nnnn	0000 11nn nnnn nnnn	1111 111n nnnn nnnn
		Increment Wiper	—	0000 0100	1111 1111
		Decrement Wiper	—	0000 1000	1111 1111
01h	Volatile Wiper 1	Write Data	nn nnnn nnnn	0001 00nn nnnn nnnn	1111 1111 1111 1111
		Read Data	nn nnnn nnnn	0001 11nn nnnn nnnn	1111 111n nnnn nnnn
		Increment Wiper	—	0001 0100	1111 1111
		Decrement Wiper	—	0001 1000	1111 1111
02h	Reserved	—	—	—	—
03h	Reserved	—	—	—	—
04h	Volatile TCON Register	Write Data	nn nnnn nnnn	0100 00nn nnnn nnnn	1111 1111 1111 1111
		Read Data	nn nnnn nnnn	0100 11nn nnnn nnnn	1111 111n nnnn nnnn
05h	Status Register	Read Data	nn nnnn nnnn	0101 11nn nnnn nnnn	1111 111n nnnn nnnn
06h-0Fh	Reserved	—	—	—	—

**Note 1:** The Data Memory is only 9-bits wide, so the MSb is ignored by the device.

**Note 2:** All these Address/Command combinations are valid, so the CMDERR bit is set. Any other Address/Command combination is a command error state and the CMDERR bit will be clear.



## 7.2 Data Byte

Only the Read Command and the Write Command use the Data Byte, see [Figure 7-1](#). These commands concatenate the 8-bits of the Data Byte with the one data bit (D8) contained in the Command Byte to form 9-bits of data (D8:D0). The Command Byte format supports up to 9-bits of data so that the 8-bit resistor network can be set to Full-Scale (100h or greater). This allows wiper connections to Terminal A and to Terminal B.

The D9 bit is currently unused, and corresponds to the position on the SDO data of the CMDERR bit.

## 7.3 Error Condition

The CMDERR bit indicates if the four address bits received (AD3:AD0) and the two command bits received (C1:C0) are a valid combination (see [Table 4-1](#)). The CMDERR bit is high if the combination is valid and low if the combination is invalid.

SPI commands that do not have a multiple of 8 clocks are ignored.

Once an error condition has occurred, any following commands are ignored. All following SDO bits will be low until the CMDERR condition is cleared by forcing the  $\overline{CS}$  pin to the inactive state ( $V_{IH}$ ).

### 7.3.1 ABORTING A TRANSMISSION

All SPI transmissions must have the correct number of SCK pulses to be executed. The command is not executed until the complete number of clocks have been received. If the  $\overline{CS}$  pin is forced to the inactive state ( $V_{IH}$ ) the serial interface is reset. Partial commands are not executed.

SPI is more susceptible to noise than other bus protocols. The most likely case is that this noise corrupts the value of the data being clocked into the MCP4XXX or the SCK pin is injected with extra clock pulses. This may cause data to be corrupted in the device, or a command error to occur, since the address and command bits were not a valid combination. The extra SCK pulse will also cause the SPI data (SDI) and clock (SCK) to be out of sync. Forcing the  $\overline{CS}$  pin to the inactive state ( $V_{IH}$ ) resets the serial interface. The SPI interface will ignore activity on the SDI and SCK pins until the  $\overline{CS}$  pin transition to the active state is detected ( $V_{IH}$  to  $V_{IL}$  or  $V_{IH}$  to  $V_{IHH}$ ).

- Note 1:** When data is not being received by the MCP4XXX, It is recommended that the  $\overline{CS}$  pin be forced to the inactive level ( $V_{IL}$ )
- 2:** It is also recommended that long continuous command strings should be broken down into single commands or shorter continuous command strings. This reduces the probability of noise on the SCK pin corrupting the desired SPI commands.

# MCP413X/415X/423X/425X

## 7.4 Continuous Commands

The device supports the ability to execute commands continuously. While the  $\overline{\text{CS}}$  pin is in the active state ( $V_{\text{IL}}$  or  $V_{\text{IHH}}$ ). Any sequence of valid commands may be received.

The following example is a valid sequence of events:

1.  $\overline{\text{CS}}$  pin driven active ( $V_{\text{IL}}$  or  $V_{\text{IHH}}$ ).
2. Read Command.
3. Increment Command (Wiper 0).
4. Increment Command (Wiper 0).
5. Decrement Command (Wiper 1).
6. Write Command.
7. Write Command.
8.  $\overline{\text{CS}}$  pin driven inactive ( $V_{\text{IH}}$ ).

**Note 1:** It is recommended that while the  $\overline{\text{CS}}$  pin is active, only one type of command should be issued. When changing commands, it is recommended to take the  $\overline{\text{CS}}$  pin inactive then force it back to the active state.

**2:** It is also recommended that long command strings should be broken down into shorter command strings. This reduces the probability of noise on the SCK pin corrupting the desired SPI command string.

**TABLE 7-3: COMMANDS**

Command Name	# of Bits	High Voltage ( $V_{\text{IHH}}$ ) on CS pin?
Write Data	16-Bits	—
Read Data	16-Bits	—
Increment Wiper	8-Bits	—
Decrement Wiper	8-Bits	—
High Voltage Write Data	16-Bits	Yes
High Voltage Read Data	16-Bits	Yes
High Voltage Increment Wiper	8-Bits	Yes
High Voltage Decrement Wiper	8-Bits	Yes

# MCP413X/415X/423X/425X

## 7.5 Write Data Normal and High Voltage

**Note:** The High Voltage Write Data command is supported for compatibility with system that also support MCP414X/416X/424X/426X devices.

The Write command is a 16-bit command. The format of the command is shown in [Figure 7-2](#).

A Write command to a Volatile memory location changes that location after a properly formatted Write Command (16-clock) have been received.

### 7.5.1 SINGLE WRITE

The write operation requires that the  $\overline{CS}$  pin be in the active state ( $V_{IL}$  or  $V_{IHH}$ ). Typically, the  $\overline{CS}$  pin will be in the inactive state ( $V_{IH}$ ) and is driven to the active state ( $V_{IL}$ ). The 16-bit Write Command (Command Byte and Data Byte) is then clocked in on the SCK and SDI pins. Once all 16 bits have been received, the specified volatile address is updated. A write will not occur if the write command isn't exactly 16 clocks pulses. This protects against system issues from corrupting the memory locations.

[Figure 6-3](#) and [Figure 6-4](#) show possible waveforms for a single write.



**FIGURE 7-2:** Write Command - SDI and SDO States.

# MCP413X/415X/423X/425X

## 7.5.2 CONTINUOUS WRITES

Continuous writes are possible only when writing to the volatile memory registers (address 00h, 01h, and 04h).

Figure 7-3 shows the sequence for three continuous writes. The writes do not need to be to the same volatile memory address.



**FIGURE 7-3:** Continuous Write Sequence.

# MCP413X/415X/423X/425X

## 7.6 Read Data Normal and High Voltage

**Note:** The High Voltage Read Data command is supported for compatibility with system that also support MCP414X/416X/424X/426X devices.

The Read command is a 16-bit command. The format of the command is shown in Figure 7-4.

The first 6-bits of the Read command determine the address and the command. The 7th clock will output the CMDERR bit on the SDO pin. The remaining 9-clocks the device will transmit the 9 data bits (D8:D0) of the specified address (AD3:AD0).

Figure 7-4 shows the SDI and SDO information for a Read command.

### 7.6.1 SINGLE READ

The read operation requires that the  $\overline{CS}$  pin be in the active state ( $V_{IL}$  or  $V_{IHH}$ ). Typically, the  $\overline{CS}$  pin will be in the inactive state ( $V_{IH}$ ) and is driven to the active state ( $V_{IL}$  or  $V_{IHH}$ ). The 16-bit Read Command (Command Byte and Data Byte) is then clocked in on the SCK and SDI pins. The SDO pin starts driving data on the 7th bit (CMDERR bit) and the addressed data comes out on the 8th through 16th clocks. Figure 6-3 through Figure 6-6 show possible waveforms for a single read.

Figure 6-5 and Figure 6-6 show the single read waveforms when the SDI and SDO signals are multiplexed on the same pin. For additional information on the multiplexing of these signals, refer to Section 6.1.3 "SDI/SDO".



**FIGURE 7-4:** Read Command - SDI and SDO States.

# MCP413X/415X/423X/425X

## 7.6.2 CONTINUOUS READS

Continuous reads allows the devices memory to be read quickly. Continuous reads are possible to all memory locations.

Figure 7-5 shows the sequence for three continuous reads. The reads do not need to be to the same memory address.



**FIGURE 7-5:** Continuous Read Sequence.

## 7.7 Increment Wiper Normal and High Voltage

**Note:** The High Voltage Increment Wiper command is supported for compatibility with system that also support MCP414X/416X/424X/426X devices.

The Increment Command is an 8-bit command. The Increment Command can only be issued to wiper memory locations. The format of the command is shown in Figure 7-6.

An Increment Command to the wiper memory location changes that location after a properly formatted command (8-clocks) have been received.

Increment commands provide a quick and easy method to modify the value of the wiper location by +1 with minimal overhead.



**FIGURE 7-6:** Increment Command - SDI and SDO States.

### 7.7.1 SINGLE INCREMENT

Typically, the  $\overline{CS}$  pin starts at the inactive state ( $V_{IH}$ ), but may be already be in the active state due to the completion of another command.

Figure 6-7 through Figure 6-8 show possible waveforms for a single increment. The increment operation requires that the  $\overline{CS}$  pin be in the active state ( $V_{IL}$  or  $V_{IHH}$ ). Typically, the  $\overline{CS}$  pin will be in the inactive state ( $V_{IH}$ ) and is driven to the active state ( $V_{IL}$  or  $V_{IHH}$ ). The 8-bit Increment Command (Command Byte) is then clocked in on the SDI pin by the SCK pins. The SDO pin drives the CMDERR bit on the 7th clock.

The wiper value will increment up to 100h on 8-bit devices and 80h on 7-bit devices. After the wiper value has reached Full-Scale (8-bit = 100h, 7-bit = 80h), the wiper value will not be incremented further. If the Wiper register has a value between 101h and 1FFh, the Increment command is disabled. See Table 7-4 for additional information on the Increment Command versus the current volatile wiper value.

The Increment operations only require the Increment command byte while the  $\overline{CS}$  pin is active ( $V_{IL}$  or  $V_{IHH}$ ) for a single increment.

After the wiper is incremented to the desired position, the  $\overline{CS}$  pin should be forced to  $V_{IH}$  to ensure that unexpected transitions on the SCK pin do not cause the wiper setting to change. Driving the  $\overline{CS}$  pin to  $V_{IH}$  should occur as soon as possible (within device specifications) after the last desired increment occurs.

**TABLE 7-4: INCREMENT OPERATION VS. VOLATILE WIPER VALUE**

Current Wiper Setting		Wiper (W) Properties	Increment Command Operates?
7-bit Pot	8-bit Pot		
3FFh	3FFh	Reserved	No
081h	101h	(Full-Scale (W = A))	No
080h	100h	Full-Scale (W = A)	No
07Fh	0FFh	W = N	Yes
041h	081		
040h	080h	W = N (Mid-Scale)	
03Fh	07Fh	W = N	
001h	001		
000h	000h	Zero Scale (W = B)	Yes

# MCP413X/415X/423X/425X

## 7.7.2 CONTINUOUS INCREMENTS

Continuous Increments are possible only when writing to the wiper registers.

Figure 7-7 shows a Continuous Increment sequence for three continuous writes. The writes do not need to be to the same volatile memory address.

When executing an continuous Increment commands, the selected wiper will be altered from n to n+1 for each Increment command received. The wiper value will increment up to 100h on 8-bit devices and 80h on 7-bit devices. After the wiper value has reached Full-Scale (8-bit =100h, 7-bit =80h), the wiper value will not be incremented further. If the Wiper register has a value between 101h and 1FFh, the Increment command is disabled.

Increment commands can be sent repeatedly without raising  $\overline{CS}$  until a desired condition is met. The value in the Volatile Wiper register can be read using a Read Command.

When executing a continuous command string, The Increment command can be followed by any other valid command.

The wiper terminal will move after the command has been received (8th clock).

After the wiper is incremented to the desired position, the  $\overline{CS}$  pin should be forced to  $V_{IH}$  to ensure that unexpected transitions (on the SCK pin do not cause the wiper setting to change). Driving the  $\overline{CS}$  pin to  $V_{IH}$  should occur as soon as possible (within device specifications) after the last desired increment occurs.



FIGURE 7-7: Continuous Increment Command - SDI and SDO States.



## 7.8 Decrement Wiper Normal and High Voltage

**Note:** The High Voltage Decrement Wiper command is supported for compatibility with system that also support MCP414X/416X/424X/426X devices.

The Decrement Command is an 8-bit command. The Decrement Command can only be issued to wiper memory locations. The format of the command is shown in [Figure 7-6](#).

An Decrement Command to the wiper memory location changes that location after a properly formatted command (8-clocks) have been received.

Decrement commands provide a quick and easy method to modify the value of the wiper location by -1 with minimal overhead.



**FIGURE 7-8:** Decrement Command - SDI and SDO States.

### 7.8.1 SINGLE DECREMENT

Typically the  $\overline{CS}$  pin starts at the inactive state (V<sub>IH</sub>), but may be already be in the active state due to the completion of another command.

[Figure 6-7](#) through [Figure 6-8](#) show possible waveforms for a single Decrement. The decrement operation requires that the  $\overline{CS}$  pin be in the active state (V<sub>IL</sub> or V<sub>IHH</sub>). Typically the  $\overline{CS}$  pin will be in the inactive state (V<sub>IH</sub>) and is driven to the active state (V<sub>IL</sub> or V<sub>IHH</sub>). Then the 8-bit Decrement Command (Command Byte) is clocked in on the SDI pin by the SCK pins. The SDO pin drives the CMDERR bit on the 7th clock.

The wiper value will decrement from the wipers Full-Scale value (100h on 8-bit devices and 80h on 7-bit devices). Above the wipers Full-Scale value (8-bit = 101h to 1FFh, 7-bit = 81h to FFh), the decrement command is disabled. If the Wiper register has a Zero Scale value (000h), then the wiper value will not decrement. See [Table 7-4](#) for additional information on the Decrement Command vs. the current volatile wiper value.

The Decrement commands only require the Decrement command byte, while the  $\overline{CS}$  pin is active (V<sub>IL</sub> or V<sub>IHH</sub>) for a single decrement.

After the wiper is decremented to the desired position, the  $\overline{CS}$  pin should be forced to V<sub>IH</sub> to ensure that unexpected transitions on the SCK pin do not cause the wiper setting to change. Driving the  $\overline{CS}$  pin to V<sub>IH</sub> should occur as soon as possible (within device specifications) after the last desired decrement occurs.

**TABLE 7-5: DECREMENT OPERATION VS. VOLATILE WIPER VALUE**

Current Wiper Setting		Wiper (W) Properties	Decrement Command Operates?
7-bit Pot	8-bit Pot		
3FFh	3FFh	Reserved (Full-Scale (W = A))	No
080h	100h	Full-Scale (W = A)	Yes
07Fh	0FFh	W = N	Yes
041h	081	W = N (Mid-Scale)	
040h	080h	W = N	
03Fh	07Fh	W = N	No
001h	001	W = N	
000h	000h	Zero Scale (W = B)	No

# MCP413X/415X/423X/425X

## 7.8.2 CONTINUOUS DECREMENTS

Continuous Decrements are possible only when writing to the wiper registers.

Figure 7-9 shows a continuous Decrement sequence for three continuous writes. The writes do not need to be to the same volatile memory address.

When executing an continuous Decrement commands, the selected wiper will be altered from n to n-1 for each Decrement command received. The wiper value will decrement from the wipers Full-Scale value (100h on 8-bit devices and 80h on 7-bit devices). Above the wipers Full-Scale value (8-bit = 101h to 1FFh, 7-bit = 81h to FFh), the decrement command is disabled. If the Wiper register has a Zero Scale value (000h), then the wiper value will not decrement. See Table 7-4 for additional information on the Decrement Command vs. the current volatile wiper value.

Decrement commands can be sent repeatedly without raising  $\overline{CS}$  until a desired condition is met. The value in the Volatile Wiper register can be read using a Read Command.

When executing a continuous command string, The Decrement command can be followed by any other valid command.

The wiper terminal will move after the command has been received (8th clock).

After the wiper is decremented to the desired position, the  $\overline{CS}$  pin should be forced to  $V_{IH}$  to ensure that “unexpected” transitions (on the SCK pin do not cause the wiper setting to change). Driving the  $\overline{CS}$  pin to  $V_{IH}$  should occur as soon as possible (within device specifications) after the last desired decrement occurs.



FIGURE 7-9: Continuous Decrement Command - SDI and SDO States.

## 8.0 APPLICATIONS EXAMPLES

Digital potentiometers have a multitude of practical uses in modern electronic circuits. The most popular uses include precision calibration of set point thresholds, sensor trimming, LCD bias trimming, audio attenuation, adjustable power supplies, motor control overcurrent trip setting, adjustable gain amplifiers and offset trimming. The MCP413X/415X/423X/425X devices can be used to replace the common mechanical trim pot in applications where the operating and terminal voltages are within CMOS process limitations ( $V_{DD} = 2.7V$  to  $5.5V$ ).

### 8.1 Split Rail Applications

All inputs that would be used to interface to a Host Controller support High Voltage on their input pin. This allows the MCP4XXX device to be used in split power rail applications.

An example of this is a battery application where the PIC<sup>®</sup> MCU is directly powered by the battery supply ( $4.8V$ ) and the MCP4XXX device is powered by the  $3.3V$  regulated voltage.

For SPI applications, these inputs are:

- $\overline{CS}$
- SCK
- SDI (or SDI/SDO)
- $\overline{SHDN}$

Figure 8-1 through Figure 8-2 show three example split rail systems. In this system, the MCP4XXX interface input signals need to be able to support the PIC MCU output high voltage ( $V_{OH}$ ).

In Example #1 (Figure 8-1), the MCP4XXX interface input signals need to be able to support the PIC MCU output high voltage ( $V_{OH}$ ). If the split rail voltage delta becomes too large, then the customer may be required to do some level shifting due to MCP4XXX  $V_{OH}$  levels related to Host Controller  $V_{IH}$  levels.

In Example #2 (Figure 8-2), the MCP4XXX interface input signals need to be able to support the lower voltage of the PIC MCU output high voltage level ( $V_{OH}$ ).

Table 8-1 shows an example PIC microcontroller I/O voltage specifications and the MCP4XXX specifications. So this PIC MCU operating at  $3.3V$  will drive a  $V_{OH}$  at  $2.64V$ , and for the MCP4XXX operating at  $5.5V$ , the  $V_{IH}$  is  $2.47V$ . Therefore, the interface signals meet specifications.



FIGURE 8-1: Example Split Rail System 1.



FIGURE 8-2: Example Split Rail System 2.

TABLE 8-1:  $V_{OH} - V_{IH}$  COMPARISONS

PIC <sup>(1)</sup>			MCP4XXX <sup>(2)</sup>			Comment
$V_{DD}$	$V_{IH}$	$V_{OH}$	$V_{DD}$	$V_{IH}$	$V_{OH}$	
5.5	4.4	4.4	2.7	1.215	— <sup>(3)</sup>	
5.0	4.0	4.0	3.0	1.35	— <sup>(3)</sup>	
4.5	3.6	3.6	3.3	1.485	— <sup>(3)</sup>	
3.3	2.64	2.64	4.5	2.025	— <sup>(3)</sup>	
3.0	2.4	2.4	5.0	2.25	— <sup>(3)</sup>	
2.7	2.16	2.16	5.5	2.475	— <sup>(3)</sup>	

- Note 1:**  $V_{OH}$  minimum =  $0.8 * V_{DD}$ ;  
 $V_{OL}$  maximum =  $0.6V$   
 $V_{IH}$  minimum =  $0.8 * V_{DD}$ ;  
 $V_{IL}$  maximum =  $0.2 * V_{DD}$ ;
- 2:**  $V_{OH}$  minimum (SDA only) = ;  
 $V_{OL}$  maximum =  $0.2 * V_{DD}$   
 $V_{IH}$  minimum =  $0.45 * V_{DD}$ ;  
 $V_{IL}$  maximum =  $0.2 * V_{DD}$
- 3:** The only MCP4XXX output pin is SDO, which is Open-Drain (or Open-Drain with Internal Pull-up) with High Voltage Support

# MCP413X/415X/423X/425X

## 8.2 Techniques to force the $\overline{CS}$ pin to $V_{IH}$

The circuit in Figure 8-3 shows a method using the TC1240A doubling charge pump. When the SHDN pin is high, the TC1240A is off, and the level on the  $\overline{CS}$  pin is controlled by the PIC® microcontrollers (MCUs) IO2 pin.

When the SHDN pin is low, the TC1240A is on and the  $V_{OUT}$  voltage is  $2 * V_{DD}$ . The resistor  $R_1$  allows the  $\overline{CS}$  pin to go higher than the voltage such that the PIC MCU's IO2 pin "clamps" at approximately  $V_{DD}$ .



**FIGURE 8-3:** Using the TC1240A to generate the  $V_{IH}$  voltage.

The circuit in Figure 8-4 shows the method used on the MCP402X Non-volatile Digital Potentiometer Evaluation Board (Part Number: MCP402XEV). This method requires that the system voltage be approximately 5V. This ensures that when the PIC10F206 enters a brown-out condition, there is an insufficient voltage level on the  $\overline{CS}$  pin to change the stored value of the wiper. The MCP402X Non-volatile Digital Potentiometer Evaluation Board User's Guide (DS51546) contains a complete schematic.

GP0 is a general purpose I/O pin, while GP2 can either be a general purpose I/O pin or it can output the internal clock.

For the serial commands, configure the GP2 pin as an input (high-impedance). The output state of the GP0 pin will determine the voltage on the  $\overline{CS}$  pin ( $V_{IL}$  or  $V_{IH}$ ).

For high-voltage serial commands, force the GP0 output pin to output a high level ( $V_{OH}$ ) and configure the GP2 pin to output the internal clock. This will form a charge pump and increase the voltage on the  $\overline{CS}$  pin (when the system voltage is approximately 5V).



**FIGURE 8-4:** MCP4XXX Non-Volatile Digital Potentiometer Evaluation Board (MCP402XEV) implementation to generate the  $V_{IH}$  voltage.

## 8.3 Using Shutdown Modes

Figure 8-5 shows a possible application circuit where the independent terminals could be used. Disconnecting the wiper allows the transistor input to be taken to the Bias voltage level (disconnecting A and or B may be desired to reduce system current). Disconnecting Terminal A modifies the transistor input by the  $R_{BW}$  rheostat value to the Common B. Disconnecting Terminal B modifies the transistor input by the  $R_{AW}$  rheostat value to the Common A. The Common A and Common B connections could be connected to  $V_{DD}$  and  $V_{SS}$ .



**FIGURE 8-5:** Example Application Circuit using Terminal Disconnects.

## 8.4 Design Considerations

In the design of a system with the MCP4XXX devices, the following considerations should be taken into account:

- [Power Supply Considerations](#)
- [Layout Considerations](#)

### 8.4.1 POWER SUPPLY CONSIDERATIONS

The typical application will require a bypass capacitor in order to filter high-frequency noise, which can be induced onto the power supply's traces. The bypass capacitor helps to minimize the effect of these noise sources on signal integrity. [Figure 8-6](#) illustrates an appropriate bypass strategy.

In this example, the recommended bypass capacitor value is 0.1  $\mu\text{F}$ . This capacitor should be placed as close (within 4 mm) to the device power pin ( $V_{\text{DD}}$ ) as possible.

The power source supplying these devices should be as clean as possible. If the application circuit has separate digital and analog power supplies,  $V_{\text{DD}}$  and  $V_{\text{SS}}$  should reside on the analog plane.



**FIGURE 8-6:** Typical Microcontroller Connections.

### 8.4.2 LAYOUT CONSIDERATIONS

Inductively-coupled AC transients and digital switching noise can degrade the input and output signal integrity, potentially masking the MCP4XXX's performance. Careful board layout minimizes these effects and increases the Signal-to-Noise Ratio (SNR). Multi-layer boards utilizing a low-inductance ground plane, isolated inputs, isolated outputs and proper decoupling are critical to achieving the performance that the silicon is capable of providing. Particularly harsh environments may require shielding of critical signals.

If low noise is desired, breadboards and wire-wrapped boards are not recommended.

### 8.4.3 RESISTOR TEMPCO

Characterization curves of the resistor temperature coefficient (Tempco) are shown in [Figure 2-11](#), [Figure 2-24](#), [Figure 2-36](#), and [Figure 2-48](#).

These curves show that the resistor network is designed to correct for the change in resistance as temperature increases. This technique reduces the end to end change is  $R_{\text{AB}}$  resistance.

### 8.4.4 HIGH VOLTAGE TOLERANT PINS

High Voltage support ( $V_{\text{IHH}}$ ) on the Serial Interface pins supports two features. These are:

- In-Circuit Accommodation of split rail applications and power supply sync issues
- Compatibility with systems that also support MCP414X/416X /424X/426X devices

# MCP413X/415X/423X/425X

---

NOTES:

# MCP413X/415X/423X/425X

## 9.0 DEVELOPMENT SUPPORT

### 9.1 Development Tools

Several development tools are available to assist in your design and evaluation of the MCP4XXX devices. The currently available tools are shown in [Table 9-1](#).

These boards may be purchased directly from the Microchip web site at [www.microchip.com](http://www.microchip.com).

**TABLE 9-1: DEVELOPMENT TOOLS**

Board Name	Part #	Supported Devices
MCP42XX Digital Potentiometer PICtail Plus Demo Board	MCP42XXDM-PTPLS	MCP42XX
MCP4XXX Digital Potentiometer Daughter Board <sup>(1)</sup>	MCP4XXXDM-DB	MCP42XXX, MCP42XX, MCP4021, and MCP4011
8-pin SOIC/MSOP/TSSOP/DIP Evaluation Board	SOIC8EV	Any 8-pin device in DIP, SOIC, MSOP, or TSSOP package
14-pin SOIC/MSOP/DIP Evaluation Board	SOIC14EV	Any 14-pin device in DIP, SOIC, or MSOP package

**Note 1:** Requires the use of a PICDEM Demo board (see User's Guide for details)

**TABLE 9-2: TECHNICAL DOCUMENTATION**

Application Note Number	Title	Literature #
AN1080	Understanding Digital Potentiometers Resistor Variations	DS01080
AN737	Using Digital Potentiometers to Design Low Pass Adjustable Filters	DS00737
AN692	Using a Digital Potentiometer to Optimize a Precision Single Supply Photo Detect	DS00692
AN691	Optimizing the Digital Potentiometer in Precision Circuits	DS00691
AN219	Comparing Digital Potentiometers to Mechanical Potentiometers	DS00219
—	Digital Potentiometer Design Guide	DS22017
—	Signal Chain Design Guide	DS21825

# MCP413X/415X/423X/425X

---

NOTES:



# MCP413X/415X/423X/425X

## 10.0 PACKAGING INFORMATION

### 10.1 Package Marking Information

8-Lead DFN (3x3)



Part Number	Code	Part Number	Code
MCP4131-502E/MF	DAAE	MCP4132-502E/MF	DAAY
MCP4131-103E/MF	DAAF	MCP4132-103E/MF	DAAZ
MCP4131-104E/MF	DAAH	MCP4132-104E/MF	DABB
MCP4131-503E/MF	DAAG	MCP4132-503E/MF	DABA
MCP4151-502E/MF	DAAP	MCP4152-502E/MF	DAAA
MCP4151-103E/MF	DAAQ	MCP4152-103E/MF	DABD
MCP4151-104E/MF	DAAS	MCP4152-104E/MF	DAAD
MCP4151-503E/MF	DAAR	MCP4152-503E/MF	DAAC

Example:



8-Lead MSOP



Part Number	Code	Part Number	Code
MCP4131-502E/MS	413152	MCP4132-502E/MS	413252
MCP4131-103E/MS	413113	MCP4132-103E/MS	413213
MCP4131-104E/MS	413114	MCP4132-104E/MS	413214
MCP4131-503E/MS	413153	MCP4132-503E/MS	413253
MCP4151-502E/MS	415152	MCP4152-502E/MS	415252
MCP4151-103E/MS	415113	MCP4152-103E/MS	415213
MCP4151-104E/MS	415114	MCP4152-104E/MS	415214
MCP4151-503E/MS	415153	MCP4152-503E/MS	415253

Example



8-Lead PDIP



Example



8-Lead SOIC



Example



<b>Legend:</b>	XX...X	Customer-specific information
	Y	Year code (last digit of calendar year)
	YY	Year code (last 2 digits of calendar year)
	WW	Week code (week of January 1 is week '01')
	NNN	Alphanumeric traceability code
	(e3)	Pb-free JEDEC designator for Matte Tin (Sn)
	*	This package is Pb-free. The Pb-free JEDEC designator (e3) can be found on the outer packaging for this package.

**Note:** In the event the full Microchip part number cannot be marked on one line, it will be carried over to the next line, thus limiting the number of available characters for customer-specific information.

# MCP413X/415X/423X/425X

## Package Marking Information (Continued)

10-Lead DFN (3x3)



Part Number	Code	Part Number	Code
MCP4232-502E/MF	BAEH	MCP4252-502E/MF	BAES
MCP4232-103E/MF	BAEJ	MCP4252-103E/MF	BAET
MCP4232-104E/MF	BAEL	MCP4252-104E/MF	BAEV
MCP4232-503E/MF	BAEK	MCP4252-503E/MF	BAEU

Example:



10-Lead MSOP



Part Number	Code	Part Number	Code
MCP4232-502E/MS	423252	MCP4252-502E/MS	425252
MCP4232-103E/MS	423213	MCP4252-103E/MS	425213
MCP4232-104E/MS	423214	MCP4252-104E/MS	425214
MCP4232-503E/MS	423253	MCP4252-503E/MS	425253

Example



14-Lead PDIP



Example



14-Lead SOIC (.150")



Example



14-Lead TSSOP



Example



16-Lead QFN



Example



# MCP413X/415X/423X/425X

## 8-Lead Plastic Dual Flat, No Lead Package (MF) – 3x3x0.9 mm Body [DFN]

**Note:** For the most current package drawings, please see the Microchip Packaging Specification located at <http://www.microchip.com/packaging>



Dimension Limits	Units	MILLIMETERS		
		MIN	NOM	MAX
Number of Pins	N	8		
Pitch	e	0.65 BSC		
Overall Height	A	0.80	0.90	1.00
Standoff	A1	0.00	0.02	0.05
Contact Thickness	A3	0.20 REF		
Overall Length	D	3.00 BSC		
Exposed Pad Width	E2	0.00	–	1.60
Overall Width	E	3.00 BSC		
Exposed Pad Length	D2	0.00	–	2.40
Contact Width	b	0.25	0.30	0.35
Contact Length	L	0.20	0.30	0.55
Contact-to-Exposed Pad	K	0.20	–	–

**Notes:**

- Pin 1 visual index feature may vary, but must be located within the hatched area.
- Package may have one or more exposed tie bars at ends.
- Package is saw singulated.
- Dimensioning and tolerancing per ASME Y14.5M.

BSC: Basic Dimension. Theoretically exact value shown without tolerances.

REF: Reference Dimension, usually without tolerance, for information purposes only.

Microchip Technology Drawing C04-062B

# MCP413X/415X/423X/425X

## 8-Lead Plastic Dual Flat, No Lead Package (MF) – 3x3x0.9 mm Body [DFN]

**Note:** For the most current package drawings, please see the Microchip Packaging Specification located at <http://www.microchip.com/packaging>



RECOMMENDED LAND PATTERN

Dimension Limits	Units	MILLIMETERS		
		MIN	NOM	MAX
Contact Pitch	E	0.65 BSC		
Optional Center Pad Width	W2			2.40
Optional Center Pad Length	T2			1.55
Contact Pad Spacing	C1		3.10	
Contact Pad Width (X8)	X1			0.35
Contact Pad Length (X8)	Y1			0.65
Distance Between Pads	G	0.30		

Notes:

1. Dimensioning and tolerancing per ASME Y14.5M

BSC: Basic Dimension. Theoretically exact value shown without tolerances.

Microchip Technology Drawing No. C04-2062A

# MCP413X/415X/423X/425X

## 8-Lead Plastic Dual In-Line (P) – 300 mil Body [PDIP]

**Note:** For the most current package drawings, please see the Microchip Packaging Specification located at <http://www.microchip.com/packaging>



Dimension Limits	Units	INCHES		
		MIN	NOM	MAX
Number of Pins	N	8		
Pitch	e	.100 BSC		
Top to Seating Plane	A	–	–	.210
Molded Package Thickness	A2	.115	.130	.195
Base to Seating Plane	A1	.015	–	–
Shoulder to Shoulder Width	E	.290	.310	.325
Molded Package Width	E1	.240	.250	.280
Overall Length	D	.348	.365	.400
Tip to Seating Plane	L	.115	.130	.150
Lead Thickness	c	.008	.010	.015
Upper Lead Width	b1	.040	.060	.070
Lower Lead Width	b	.014	.018	.022
Overall Row Spacing §	eB	–	–	.430

**Notes:**

- Pin 1 visual index feature may vary, but must be located with the hatched area.
- § Significant Characteristic.
- Dimensions D and E1 do not include mold flash or protrusions. Mold flash or protrusions shall not exceed .010" per side.
- Dimensioning and tolerancing per ASME Y14.5M.  
BSC: Basic Dimension. Theoretically exact value shown without tolerances.

Microchip Technology Drawing C04-018B

# MCP413X/415X/423X/425X

## 8-Lead Plastic Micro Small Outline Package (MS) [MSOP]

**Note:** For the most current package drawings, please see the Microchip Packaging Specification located at <http://www.microchip.com/packaging>



Dimension Limits	Units	MILLIMETERS		
		MIN	NOM	MAX
Number of Pins	N	8		
Pitch	e	0.65 BSC		
Overall Height	A	-	-	1.10
Molded Package Thickness	A2	0.75	0.85	0.95
Standoff	A1	0.00	-	0.15
Overall Width	E	4.90 BSC		
Molded Package Width	E1	3.00 BSC		
Overall Length	D	3.00 BSC		
Foot Length	L	0.40	0.60	0.80
Footprint	L1	0.95 REF		
Foot Angle	$\phi$	0°	-	8°
Lead Thickness	c	0.08	-	0.23
Lead Width	b	0.22	-	0.40

**Notes:**

- Pin 1 visual index feature may vary, but must be located within the hatched area.
- Dimensions D and E1 do not include mold flash or protrusions. Mold flash or protrusions shall not exceed 0.15 mm per side.
- Dimensioning and tolerancing per ASME Y14.5M.

BSC: Basic Dimension. Theoretically exact value shown without tolerances.

REF: Reference Dimension, usually without tolerance, for information purposes only.

Microchip Technology Drawing C04-111B

# MCP413X/415X/423X/425X

## 8-Lead Plastic Small Outline (SN) – Narrow, 3.90 mm Body [SOIC]

**Note:** For the most current package drawings, please see the Microchip Packaging Specification located at <http://www.microchip.com/packaging>

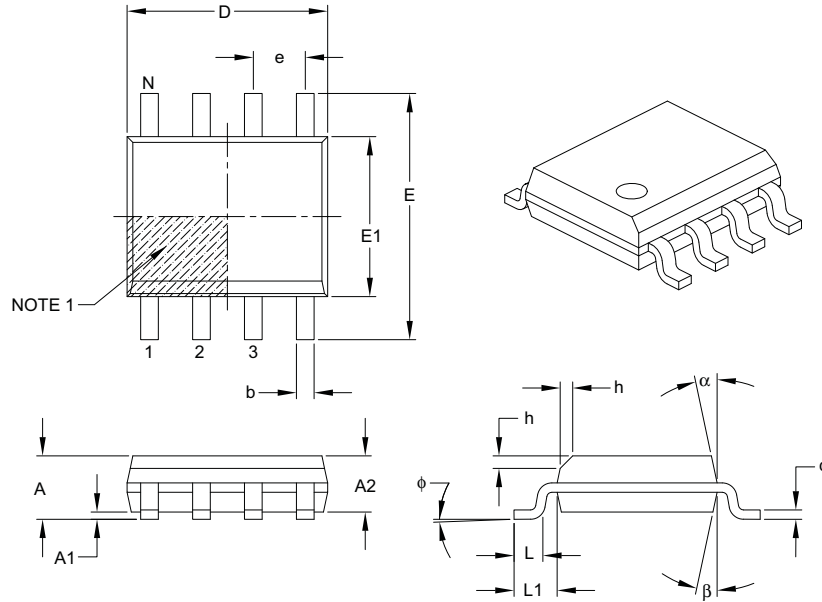

Dimension Limits	Units	MILLIMETERS		
		MIN	NOM	MAX
Number of Pins	N	8		
Pitch	e	1.27 BSC		
Overall Height	A	–	–	1.75
Molded Package Thickness	A2	1.25	–	–
Standoff §	A1	0.10	–	0.25
Overall Width	E	6.00 BSC		
Molded Package Width	E1	3.90 BSC		
Overall Length	D	4.90 BSC		
Chamfer (optional)	h	0.25	–	0.50
Foot Length	L	0.40	–	1.27
Footprint	L1	1.04 REF		
Foot Angle	$\phi$	0°	–	8°
Lead Thickness	c	0.17	–	0.25
Lead Width	b	0.31	–	0.51
Mold Draft Angle Top	$\alpha$	5°	–	15°
Mold Draft Angle Bottom	$\beta$	5°	–	15°

**Notes:**

- Pin 1 visual index feature may vary, but must be located within the hatched area.
- § Significant Characteristic.
- Dimensions D and E1 do not include mold flash or protrusions. Mold flash or protrusions shall not exceed 0.15 mm per side.
- Dimensioning and tolerancing per ASME Y14.5M.

BSC: Basic Dimension. Theoretically exact value shown without tolerances.

REF: Reference Dimension, usually without tolerance, for information purposes only.

Microchip Technology Drawing C04-057B

# MCP413X/415X/423X/425X

## 8-Lead Plastic Small Outline (SN) – Narrow, 3.90 mm Body [SOIC]

**Note:** For the most current package drawings, please see the Microchip Packaging Specification located at <http://www.microchip.com/packaging>



RECOMMENDED LAND PATTERN

Dimension Limits	Units	MILLIMETERS		
		MIN	NOM	MAX
Contact Pitch	E	1.27 BSC		
Contact Pad Spacing	C	5.40		
Contact Pad Width (X8)	X1			0.60
Contact Pad Length (X8)	Y1			1.55

**Notes:**

1. Dimensioning and tolerancing per ASME Y14.5M

BSC: Basic Dimension. Theoretically exact value shown without tolerances.

Microchip Technology Drawing No. C04-2057A



# MCP413X/415X/423X/425X

## 10-Lead Plastic Dual Flat, No Lead Package (MF) – 3x3x0.9 mm Body [DFN]

**Note:** For the most current package drawings, please see the Microchip Packaging Specification located at <http://www.microchip.com/packaging>



Dimension Limits	Units	MILLIMETERS		
		MIN	NOM	MAX
Number of Pins	N	10		
Pitch	e	0.50 BSC		
Overall Height	A	0.80	0.90	1.00
Standoff	A1	0.00	0.02	0.05
Contact Thickness	A3	0.20 REF		
Overall Length	D	3.00 BSC		
Exposed Pad Length	D2	2.20	2.35	2.48
Overall Width	E	3.00 BSC		
Exposed Pad Width	E2	1.40	1.58	1.75
Contact Width	b	0.18	0.25	0.30
Contact Length	L	0.30	0.40	0.50
Contact-to-Exposed Pad	K	0.20	-	-

**Notes:**

- Pin 1 visual index feature may vary, but must be located within the hatched area.
- Package may have one or more exposed tie bars at ends.
- Package is saw singulated.
- Dimensioning and tolerancing per ASME Y14.5M.

BSC: Basic Dimension. Theoretically exact value shown without tolerances.

REF: Reference Dimension, usually without tolerance, for information purposes only.

Microchip Technology Drawing C04-063B

# MCP413X/415X/423X/425X

## 10-Lead Plastic Dual Flat, No Lead Package (MF) – 3x3x0.9 mm Body [DFN]

**Note:** For the most current package drawings, please see the Microchip Packaging Specification located at <http://www.microchip.com/packaging>



### RECOMMENDED LAND PATTERN

Dimension Limits	Units	MILLIMETERS		
		MIN	NOM	MAX
Contact Pitch	E	0.50 BSC		
Optional Center Pad Width	W2			2.48
Optional Center Pad Length	T2			1.55
Contact Pad Spacing	C1		3.10	
Contact Pad Width (X8)	X1			0.30
Contact Pad Length (X8)	Y1			0.65
Distance Between Pads	G	0.20		

**Notes:**

1. Dimensioning and tolerancing per ASME Y14.5M

BSC: Basic Dimension. Theoretically exact value shown without tolerances.

Microchip Technology Drawing No. C04-2063A

# MCP413X/415X/423X/425X

## 10-Lead Plastic Micro Small Outline Package (UN) [MSOP]

**Note:** For the most current package drawings, please see the Microchip Packaging Specification located at <http://www.microchip.com/packaging>



Dimension Limits	Units	MILLIMETERS		
		MIN	NOM	MAX
Number of Pins	N	10		
Pitch	e	0.50 BSC		
Overall Height	A	–	–	1.10
Molded Package Thickness	A2	0.75	0.85	0.95
Standoff	A1	0.00	–	0.15
Overall Width	E	4.90 BSC		
Molded Package Width	E1	3.00 BSC		
Overall Length	D	3.00 BSC		
Foot Length	L	0.40	0.60	0.80
Footprint	L1	0.95 REF		
Foot Angle	$\phi$	0°	–	8°
Lead Thickness	c	0.08	–	0.23
Lead Width	b	0.15	–	0.33

**Notes:**

- Pin 1 visual index feature may vary, but must be located within the hatched area.
- Dimensions D and E1 do not include mold flash or protrusions. Mold flash or protrusions shall not exceed 0.15 mm per side.
- Dimensioning and tolerancing per ASME Y14.5M.

BSC: Basic Dimension. Theoretically exact value shown without tolerances.

REF: Reference Dimension, usually without tolerance, for information purposes only.

Microchip Technology Drawing C04-021B

# MCP413X/415X/423X/425X

## 14-Lead Plastic Dual In-Line (P) – 300 mil Body [PDIP]

**Note:** For the most current package drawings, please see the Microchip Packaging Specification located at <http://www.microchip.com/packaging>



Dimension Limits	Units	INCHES		
		MIN	NOM	MAX
Number of Pins	N	14		
Pitch	e	.100 BSC		
Top to Seating Plane	A	–	–	.210
Molded Package Thickness	A2	.115	.130	.195
Base to Seating Plane	A1	.015	–	–
Shoulder to Shoulder Width	E	.290	.310	.325
Molded Package Width	E1	.240	.250	.280
Overall Length	D	.735	.750	.775
Tip to Seating Plane	L	.115	.130	.150
Lead Thickness	c	.008	.010	.015
Upper Lead Width	b1	.045	.060	.070
Lower Lead Width	b	.014	.018	.022
Overall Row Spacing §	eB	–	–	.430

**Notes:**

- Pin 1 visual index feature may vary, but must be located with the hatched area.
- § Significant Characteristic.
- Dimensions D and E1 do not include mold flash or protrusions. Mold flash or protrusions shall not exceed .010" per side.
- Dimensioning and tolerancing per ASME Y14.5M.  
BSC: Basic Dimension. Theoretically exact value shown without tolerances.

Microchip Technology Drawing C04-005B

# MCP413X/415X/423X/425X

## 14-Lead Plastic Small Outline (SL) – Narrow, 3.90 mm Body [SOIC]

**Note:** For the most current package drawings, please see the Microchip Packaging Specification located at <http://www.microchip.com/packaging>



Units		MILLIMETERS		
Dimension Limits		MIN	NOM	MAX
Number of Pins	N	14		
Pitch	e	1.27 BSC		
Overall Height	A	–	–	1.75
Molded Package Thickness	A2	1.25	–	–
Standoff §	A1	0.10	–	0.25
Overall Width	E	6.00 BSC		
Molded Package Width	E1	3.90 BSC		
Overall Length	D	8.65 BSC		
Chamfer (optional)	h	0.25	–	0.50
Foot Length	L	0.40	–	1.27
Footprint	L1	1.04 REF		
Foot Angle	$\phi$	0°	–	8°
Lead Thickness	c	0.17	–	0.25
Lead Width	b	0.31	–	0.51
Mold Draft Angle Top	$\alpha$	5°	–	15°
Mold Draft Angle Bottom	$\beta$	5°	–	15°

**Notes:**

- Pin 1 visual index feature may vary, but must be located within the hatched area.
- § Significant Characteristic.
- Dimensions D and E1 do not include mold flash or protrusions. Mold flash or protrusions shall not exceed 0.15 mm per side.
- Dimensioning and tolerancing per ASME Y14.5M.

BSC: Basic Dimension. Theoretically exact value shown without tolerances.

REF: Reference Dimension, usually without tolerance, for information purposes only.

Microchip Technology Drawing C04-065B

# MCP413X/415X/423X/425X

14-Lead Plastic Small Outline (SL) - Narrow, 3.90 mm Body [SOIC]

**Note:** For the most current package drawings, please see the Microchip Packaging Specification located at <http://www.microchip.com/packaging>



RECOMMENDED LAND PATTERN

Dimension Limits	Units	MILLIMETERS		
		MIN	NOM	MAX
Contact Pitch	E	1.27 BSC		
Contact Pad Spacing	C		5.40	
Contact Pad Width	X			0.60
Contact Pad Length	Y			1.50
Distance Between Pads	Gx	0.67		
Distance Between Pads	G	3.90		

**Notes:**

1. Dimensioning and tolerancing per ASME Y14.5M

BSC: Basic Dimension. Theoretically exact value shown without tolerances.

Microchip Technology Drawing No. C04-2065A

# MCP413X/415X/423X/425X

## 14-Lead Plastic Thin Shrink Small Outline (ST) – 4.4 mm Body [TSSOP]

**Note:** For the most current package drawings, please see the Microchip Packaging Specification located at <http://www.microchip.com/packaging>



Dimension Limits	Units	MILLIMETERS		
		MIN	NOM	MAX
Number of Pins	N	14		
Pitch	e	0.65 BSC		
Overall Height	A	–	–	1.20
Molded Package Thickness	A2	0.80	1.00	1.05
Standoff	A1	0.05	–	0.15
Overall Width	E	6.40 BSC		
Molded Package Width	E1	4.30	4.40	4.50
Molded Package Length	D	4.90	5.00	5.10
Foot Length	L	0.45	0.60	0.75
Footprint	L1	1.00 REF		
Foot Angle	$\phi$	0°	–	8°
Lead Thickness	c	0.09	–	0.20
Lead Width	b	0.19	–	0.30

**Notes:**

- Pin 1 visual index feature may vary, but must be located within the hatched area.
- Dimensions D and E1 do not include mold flash or protrusions. Mold flash or protrusions shall not exceed 0.15 mm per side.
- Dimensioning and tolerancing per ASME Y14.5M.

BSC: Basic Dimension. Theoretically exact value shown without tolerances.

REF: Reference Dimension, usually without tolerance, for information purposes only.

Microchip Technology Drawing C04-087B

# MCP413X/415X/423X/425X

## 16-Lead Plastic Quad Flat, No Lead Package (ML) – 4x4x0.9 mm Body [QFN]

**Note:** For the most current package drawings, please see the Microchip Packaging Specification located at <http://www.microchip.com/packaging>



		Units	MILLIMETERS		
Dimension Limits			MIN	NOM	MAX
Number of Pins	N		16		
Pitch	e		0.65 BSC		
Overall Height	A	0.80	0.90	1.00	
Standoff	A1	0.00	0.02	0.05	
Contact Thickness	A3	0.20 REF			
Overall Width	E	4.00 BSC			
Exposed Pad Width	E2	2.50	2.65	2.80	
Overall Length	D	4.00 BSC			
Exposed Pad Length	D2	2.50	2.65	2.80	
Contact Width	b	0.25	0.30	0.35	
Contact Length	L	0.30	0.40	0.50	
Contact-to-Exposed Pad	K	0.20	-	-	

**Notes:**

- Pin 1 visual index feature may vary, but must be located within the hatched area.
- Package is saw singulated.
- Dimensioning and tolerancing per ASME Y14.5M.
  - BSC: Basic Dimension. Theoretically exact value shown without tolerances.
  - REF: Reference Dimension, usually without tolerance, for information purposes only.

Microchip Technology Drawing C04-127B



# MCP413X/415X/423X/425X

16-Lead Plastic Quad Flat, No Lead Package (ML) - 4x4x0.9mm Body [QFN]

**Note:** For the most current package drawings, please see the Microchip Packaging Specification located at <http://www.microchip.com/packaging>



RECOMMENDED LAND PATTERN

Dimension Limits	Units	MILLIMETERS		
		MIN	NOM	MAX
Contact Pitch	E	0.65 BSC		
Optional Center Pad Width	W2			2.50
Optional Center Pad Length	T2			2.50
Contact Pad Spacing	C1		4.00	
Contact Pad Spacing	C2		4.00	
Contact Pad Width (X28)	X1			0.35
Contact Pad Length (X28)	Y1			0.80
Distance Between Pads	G	0.30		

Notes:

1. Dimensioning and tolerancing per ASME Y14.5M

BSC: Basic Dimension. Theoretically exact value shown without tolerances.

Microchip Technology Drawing No. C04-2127A

# MCP413X/415X/423X/425X

---

NOTES:

## APPENDIX A: REVISION HISTORY

### Revision B (December 2008)

The following is the list of modifications:

1. Updated I<sub>PU</sub> specifications to specify test conditions and new limit.
2. Updated DFN package in “**Package Types (top view)**”, including Exposed Thermal Pad sample (EP).
3. Added new descriptions in **Section 3.0 “Pin Descriptions”**.
4. Added new Development Tool support items.
5. Updated Package Outline section.

### Revision A (September 2007)

- Original Release of this Document.

## APPENDIX B: MIGRATING FROM THE MCP41XXX AND MCP42XXX DEVICES

This is intended to give an overview of some of the differences to be aware of when migrating from the MCP41XXX and MCP42XXX devices.

### B.1 MCP41XXX to MCP41XX Differences

Here are some of the differences to be aware of:

1. SI pin is now SDI/SDO pin, and the contents of the device memory can be read.
2. Need to address the Terminal Connect Feature (TCON register) of MCP41XX.
3. MCP41XX supports software Shutdown mode.
4. New 5 k $\Omega$  version.
5. MCP41XX have 7-bit resolution options.
6. Alternate pinout versions (for Rheostat configuration).
7. Verify device’s electrical specifications.
8. Interface signals are now high voltage tolerant.
9. Interface signals now have internal pull-up resistors.

### B.2 MCP42XXX to MCP42XX Differences

Here are some of the differences to be aware of:

1. Daisy chaining of devices is no longer supported.
2. SDO pin allows contents of device memory to be read.
3. Need to address the Terminal Connect Feature (TCON register) of MCP42XX.
4. MCP42XX supports software Shutdown mode.
5. New 5 k $\Omega$  version.
6. MCP42XX have 7-bit resolution options.
7. Alternate package/pinout versions (for Rheostat configuration).
8. Verify device’s electrical specifications.
9. Interface signals are now high voltage tolerant
10. Interface signals now have internal pull-up resistors.

# MCP413X/415X/423X/425X

---

NOTES:

# MCP413X/415X/423X/425X

## PRODUCT IDENTIFICATION SYSTEM

To order or obtain information, e.g., on pricing or delivery, refer to the factory or the listed sales office.

<u>PART NO.</u>		<u>XXX</u>	<u>X</u>	<u>/XX</u>
Device		Resistance Version	Temperature Range	Package
Device	MCP4131: MCP4131T:	Single Volatile 7-bit Potentiometer Single Volatile 7-bit Potentiometer (Tape and Reel)		
	MCP4132: MCP4132T:	Single Volatile 7-bit Rheostat Single Volatile 7-bit Rheostat (Tape and Reel)		
	MCP4151: MCP4151T:	Single Volatile 8-bit Potentiometer Single Volatile 8-bit Potentiometer (Tape and Reel)		
	MCP4152: MCP4152T:	Single Volatile 8-bit Rheostat Single Volatile 8-bit Rheostat (Tape and Reel)		
	MCP4231: MCP4231T:	Dual Volatile 7-bit Potentiometer Dual Volatile 7-bit Potentiometer (Tape and Reel)		
	MCP4232: MCP4232T:	Dual Volatile 7-bit Rheostat Dual Volatile 7-bit Rheostat (Tape and Reel)		
	MCP4251: MCP4251T:	Dual Volatile 8-bit Potentiometer Dual Volatile 8-bit Potentiometer (Tape and Reel)		
	MCP4252: MCP4252T:	Dual Volatile 8-bit Rheostat Dual Volatile 8-bit Rheostat (Tape and Reel)		
Resistance Version:	502	= 5 kΩ		
	103	= 10 kΩ		
	503	= 50 kΩ		
	104	= 100 kΩ		
Temperature Range	I	= -40°C to +85°C (Industrial)		
	E	= -40°C to +125°C (Extended)		
Package	MF	= Plastic Dual Flat No-lead (3x3 DFN), 8/10-lead		
	ML	= Plastic Quad Flat No-lead (QFN), 16-lead		
	MS	= Plastic Micro Small Outline (MSOP), 8-lead		
	P	= Plastic Dual In-line (PDIP) (300 mil), 8/14-lead		
	SN	= Plastic Small Outline (SOIC), (150 mil), 8-lead		
	SL	= Plastic Small Outline (SOIC), (150 mil), 14-lead		
	ST	= Plastic Thin Shrink Small Outline (TSSOP), 14-lead		
	UN	= Plastic Micro Small Outline (MSOP), 10-lead		

<b>Examples:</b>	
a)	MCP4131-502E/XX: 5 kΩ, 8LD Device
b)	MCP4131T-502E/XX: T/R, 5 kΩ, 8LD Device
c)	MCP4131-103E/XX: 10 kΩ, 8-LD Device
d)	MCP4131T-103E/XX: T/R, 10 kΩ, 8LD Device
e)	MCP4131-503E/XX: 50 kΩ, 8LD Device
f)	MCP4131T-503E/XX: T/R, 50 kΩ, 8LD Device
g)	MCP4131-104E/XX: 100 kΩ, 8LD Device
h)	MCP4131T-104E/XX: T/R, 100 kΩ, 8LD Device
a)	MCP4132-502E/XX: 5 kΩ, 8LD Device
b)	MCP4132T-502E/XX: T/R, 5 kΩ, 8LD Device
c)	MCP4132-103E/XX: 10 kΩ, 8-LD Device
d)	MCP4132T-103E/XX: T/R, 10 kΩ, 8LD Device
e)	MCP4132-503E/XX: 50 kΩ, 8LD Device
f)	MCP4132T-503E/XX: T/R, 50 kΩ, 8LD Device
g)	MCP4132-104E/XX: 100 kΩ, 8LD Device
h)	MCP4132T-104E/XX: T/R, 100 kΩ, 8LD Device
a)	MCP4151-502E/XX: 5 kΩ, 8LD Device
b)	MCP4151T-502E/XX: T/R, 5 kΩ, 8LD Device
c)	MCP4151-103E/XX: 10 kΩ, 8-LD Device
d)	MCP4151T-103E/XX: T/R, 10 kΩ, 8LD Device
e)	MCP4151-503E/XX: 50 kΩ, 8LD Device
f)	MCP4151T-503E/XX: T/R, 50 kΩ, 8LD Device
g)	MCP4151-104E/XX: 100 kΩ, 8LD Device
h)	MCP4151T-104E/XX: T/R, 100 kΩ, 8LD Device
a)	MCP4152-502E/XX: 5 kΩ, 8LD Device
b)	MCP4152T-502E/XX: T/R, 5 kΩ, 8LD Device
c)	MCP4152-103E/XX: 10 kΩ, 8-LD Device
d)	MCP4152T-103E/XX: T/R, 10 kΩ, 8LD Device
e)	MCP4152-503E/XX: 50 kΩ, 8LD Device
f)	MCP4152T-503E/XX: T/R, 50 kΩ, 8LD Device
g)	MCP4152-104E/XX: 100 kΩ, 8LD Device
h)	MCP4152T-104E/XX: T/R, 100 kΩ, 8LD Device
a)	MCP4231-502E/XX: 5 kΩ, 8LD Device
b)	MCP4231T-502E/XX: T/R, 5 kΩ, 8LD Device
c)	MCP4231-103E/XX: 10 kΩ, 8-LD Device
d)	MCP4231T-103E/XX: T/R, 10 kΩ, 8LD Device
e)	MCP4231-503E/XX: 50 kΩ, 8LD Device
f)	MCP4231T-503E/XX: T/R, 50 kΩ, 8LD Device
g)	MCP4231-104E/XX: 100 kΩ, 8LD Device
h)	MCP4231T-104E/XX: T/R, 100 kΩ, 8LD Device
a)	MCP4232-502E/XX: 5 kΩ, 8LD Device
b)	MCP4232T-502E/XX: T/R, 5 kΩ, 8LD Device
c)	MCP4232-103E/XX: 10 kΩ, 8-LD Device
d)	MCP4232T-103E/XX: T/R, 10 kΩ, 8LD Device
e)	MCP4232-503E/XX: 50 kΩ, 8LD Device
f)	MCP4232T-503E/XX: T/R, 50 kΩ, 8LD Device
g)	MCP4232-104E/XX: 100 kΩ, 8LD Device
h)	MCP4232T-104E/XX: T/R, 100 kΩ, 8LD Device
a)	MCP4251-502E/XX: 5 kΩ, 8LD Device
b)	MCP4251T-502E/XX: T/R, 5 kΩ, 8LD Device
c)	MCP4251-103E/XX: 10 kΩ, 8-LD Device
d)	MCP4251T-103E/XX: T/R, 10 kΩ, 8LD Device
e)	MCP4251-503E/XX: 50 kΩ, 8LD Device
f)	MCP4251T-503E/XX: T/R, 50 kΩ, 8LD Device
g)	MCP4251-104E/XX: 100 kΩ, 8LD Device
h)	MCP4251T-104E/XX: T/R, 100 kΩ, 8LD Device
a)	MCP4252-502E/XX: 5 kΩ, 8LD Device
b)	MCP4252T-502E/XX: T/R, 5 kΩ, 8LD Device
c)	MCP4252-103E/XX: 10 kΩ, 8-LD Device
d)	MCP4252T-103E/XX: T/R, 10 kΩ, 8LD Device
e)	MCP4252-503E/XX: 50 kΩ, 8LD Device
f)	MCP4252T-503E/XX: T/R, 50 kΩ, 8LD Device
g)	MCP4252-104E/XX: 100 kΩ, 8LD Device
h)	MCP4252T-104E/XX: T/R, 100 kΩ, 8LD Device
XX	= MF for 8/10-lead 3x3 DFN
	= ML for 16-lead QFN
	= MS for 8-lead MSOP
	= P for 8/14-lead PDIP
	= SN for 8-lead SOIC
	= SL for 14-lead SOIC
	= ST for 14-lead TSSOP
	= UN for 10-lead MSOP

# MCP413X/415X/423X/425X

---

NOTES:

---

**Note the following details of the code protection feature on Microchip devices:**

- Microchip products meet the specification contained in their particular Microchip Data Sheet.
- Microchip believes that its family of products is one of the most secure families of its kind on the market today, when used in the intended manner and under normal conditions.
- There are dishonest and possibly illegal methods used to breach the code protection feature. All of these methods, to our knowledge, require using the Microchip products in a manner outside the operating specifications contained in Microchip's Data Sheets. Most likely, the person doing so is engaged in theft of intellectual property.
- Microchip is willing to work with the customer who is concerned about the integrity of their code.
- Neither Microchip nor any other semiconductor manufacturer can guarantee the security of their code. Code protection does not mean that we are guaranteeing the product as “unbreakable.”

Code protection is constantly evolving. We at Microchip are committed to continuously improving the code protection features of our products. Attempts to break Microchip's code protection feature may be a violation of the Digital Millennium Copyright Act. If such acts allow unauthorized access to your software or other copyrighted work, you may have a right to sue for relief under that Act.

---

Information contained in this publication regarding device applications and the like is provided only for your convenience and may be superseded by updates. It is your responsibility to ensure that your application meets with your specifications. MICROCHIP MAKES NO REPRESENTATIONS OR WARRANTIES OF ANY KIND WHETHER EXPRESS OR IMPLIED, WRITTEN OR ORAL, STATUTORY OR OTHERWISE, RELATED TO THE INFORMATION, INCLUDING BUT NOT LIMITED TO ITS CONDITION, QUALITY, PERFORMANCE, MERCHANTABILITY OR FITNESS FOR PURPOSE. Microchip disclaims all liability arising from this information and its use. Use of Microchip devices in life support and/or safety applications is entirely at the buyer's risk, and the buyer agrees to defend, indemnify and hold harmless Microchip from any and all damages, claims, suits, or expenses resulting from such use. No licenses are conveyed, implicitly or otherwise, under any Microchip intellectual property rights.

**Trademarks**

The Microchip name and logo, the Microchip logo, Accuron, dsPIC, KEELOQ, KEELOQ logo, MPLAB, PIC, PICmicro, PICSTART, rfPIC, SmartShunt and UNI/O are registered trademarks of Microchip Technology Incorporated in the U.S.A. and other countries.

FilterLab, Linear Active Thermistor, MXDEV, MXLAB, SEEVAL, SmartSensor and The Embedded Control Solutions Company are registered trademarks of Microchip Technology Incorporated in the U.S.A.

Analog-for-the-Digital Age, Application Maestro, CodeGuard, dsPICDEM, dsPICDEM.net, dsPICworks, dsSPEAK, ECAN, ECONOMONITOR, FanSense, In-Circuit Serial Programming, ICSP, ICEPIC, Mindi, MiWi, MPASM, MPLAB Certified logo, MPLIB, MPLINK, mTouch, PICkit, PICDEM, PICDEM.net, PICtail, PIC<sup>32</sup> logo, PowerCal, PowerInfo, PowerMate, PowerTool, REAL ICE, rLAB, Select Mode, Total Endurance, WiperLock and ZENA are trademarks of Microchip Technology Incorporated in the U.S.A. and other countries.

SQTP is a service mark of Microchip Technology Incorporated in the U.S.A.

All other trademarks mentioned herein are property of their respective companies.

© 2008, Microchip Technology Incorporated, Printed in the U.S.A., All Rights Reserved.

 Printed on recycled paper.

**QUALITY MANAGEMENT SYSTEM**  
**CERTIFIED BY DNV**  
**== ISO/TS 16949:2002 ==**

*Microchip received ISO/TS-16949:2002 certification for its worldwide headquarters, design and wafer fabrication facilities in Chandler and Tempe, Arizona; Gresham, Oregon and design centers in California and India. The Company's quality system processes and procedures are for its PIC® MCUs and dsPIC® DSCs, KEELOQ® code hopping devices, Serial EEPROMs, microperipherals, nonvolatile memory and analog products. In addition, Microchip's quality system for the design and manufacture of development systems is ISO 9001:2000 certified.*



---

---

## WORLDWIDE SALES AND SERVICE

---

---

### AMERICAS

**Corporate Office**  
2355 West Chandler Blvd.  
Chandler, AZ 85224-6199  
Tel: 480-792-7200  
Fax: 480-792-7277  
Technical Support:  
<http://support.microchip.com>  
Web Address:  
[www.microchip.com](http://www.microchip.com)

**Atlanta**  
Duluth, GA  
Tel: 678-957-9614  
Fax: 678-957-1455

**Boston**  
Westborough, MA  
Tel: 774-760-0087  
Fax: 774-760-0088

**Chicago**  
Itasca, IL  
Tel: 630-285-0071  
Fax: 630-285-0075

**Dallas**  
Addison, TX  
Tel: 972-818-7423  
Fax: 972-818-2924

**Detroit**  
Farmington Hills, MI  
Tel: 248-538-2250  
Fax: 248-538-2260

**Kokomo**  
Kokomo, IN  
Tel: 765-864-8360  
Fax: 765-864-8387

**Los Angeles**  
Mission Viejo, CA  
Tel: 949-462-9523  
Fax: 949-462-9608

**Santa Clara**  
Santa Clara, CA  
Tel: 408-961-6444  
Fax: 408-961-6445

**Toronto**  
Mississauga, Ontario,  
Canada  
Tel: 905-673-0699  
Fax: 905-673-6509

### ASIA/PACIFIC

**Asia Pacific Office**  
Suites 3707-14, 37th Floor  
Tower 6, The Gateway  
Harbour City, Kowloon  
Hong Kong  
Tel: 852-2401-1200  
Fax: 852-2401-3431

**Australia - Sydney**  
Tel: 61-2-9868-6733  
Fax: 61-2-9868-6755

**China - Beijing**  
Tel: 86-10-8528-2100  
Fax: 86-10-8528-2104

**China - Chengdu**  
Tel: 86-28-8665-5511  
Fax: 86-28-8665-7889

**China - Hong Kong SAR**  
Tel: 852-2401-1200  
Fax: 852-2401-3431

**China - Nanjing**  
Tel: 86-25-8473-2460  
Fax: 86-25-8473-2470

**China - Qingdao**  
Tel: 86-532-8502-7355  
Fax: 86-532-8502-7205

**China - Shanghai**  
Tel: 86-21-5407-5533  
Fax: 86-21-5407-5066

**China - Shenyang**  
Tel: 86-24-2334-2829  
Fax: 86-24-2334-2393

**China - Shenzhen**  
Tel: 86-755-8203-2660  
Fax: 86-755-8203-1760

**China - Wuhan**  
Tel: 86-27-5980-5300  
Fax: 86-27-5980-5118

**China - Xiamen**  
Tel: 86-592-2388138  
Fax: 86-592-2388130

**China - Xian**  
Tel: 86-29-8833-7252  
Fax: 86-29-8833-7256

**China - Zhuhai**  
Tel: 86-756-3210040  
Fax: 86-756-3210049

### ASIA/PACIFIC

**India - Bangalore**  
Tel: 91-80-4182-8400  
Fax: 91-80-4182-8422

**India - New Delhi**  
Tel: 91-11-4160-8631  
Fax: 91-11-4160-8632

**India - Pune**  
Tel: 91-20-2566-1512  
Fax: 91-20-2566-1513

**Japan - Yokohama**  
Tel: 81-45-471- 6166  
Fax: 81-45-471-6122

**Korea - Daegu**  
Tel: 82-53-744-4301  
Fax: 82-53-744-4302

**Korea - Seoul**  
Tel: 82-2-554-7200  
Fax: 82-2-558-5932 or  
82-2-558-5934

**Malaysia - Kuala Lumpur**  
Tel: 60-3-6201-9857  
Fax: 60-3-6201-9859

**Malaysia - Penang**  
Tel: 60-4-227-8870  
Fax: 60-4-227-4068

**Philippines - Manila**  
Tel: 63-2-634-9065  
Fax: 63-2-634-9069

**Singapore**  
Tel: 65-6334-8870  
Fax: 65-6334-8850

**Taiwan - Hsin Chu**  
Tel: 886-3-572-9526  
Fax: 886-3-572-6459

**Taiwan - Kaohsiung**  
Tel: 886-7-536-4818  
Fax: 886-7-536-4803

**Taiwan - Taipei**  
Tel: 886-2-2500-6610  
Fax: 886-2-2508-0102

**Thailand - Bangkok**  
Tel: 66-2-694-1351  
Fax: 66-2-694-1350

### EUROPE

**Austria - Wels**  
Tel: 43-7242-2244-39  
Fax: 43-7242-2244-393

**Denmark - Copenhagen**  
Tel: 45-4450-2828  
Fax: 45-4485-2829

**France - Paris**  
Tel: 33-1-69-53-63-20  
Fax: 33-1-69-30-90-79

**Germany - Munich**  
Tel: 49-89-627-144-0  
Fax: 49-89-627-144-44

**Italy - Milan**  
Tel: 39-0331-742611  
Fax: 39-0331-466781

**Netherlands - Drunen**  
Tel: 31-416-690399  
Fax: 31-416-690340

**Spain - Madrid**  
Tel: 34-91-708-08-90  
Fax: 34-91-708-08-91

**UK - Wokingham**  
Tel: 44-118-921-5869  
Fax: 44-118-921-5820



Компания «Океан Электроники» предлагает заключение долгосрочных отношений при поставках импортных электронных компонентов на взаимовыгодных условиях!

Наши преимущества:

- Поставка оригинальных импортных электронных компонентов напрямую с производств Америки, Европы и Азии, а так же с крупнейших складов мира;
- Широкая линейка поставок активных и пассивных импортных электронных компонентов (более 30 млн. наименований);
- Поставка сложных, дефицитных, либо снятых с производства позиций;
- Оперативные сроки поставки под заказ (от 5 рабочих дней);
- Экспресс доставка в любую точку России;
- Помощь Конструкторского Отдела и консультации квалифицированных инженеров;
- Техническая поддержка проекта, помощь в подборе аналогов, поставка прототипов;
- Поставка электронных компонентов под контролем ВП;
- Система менеджмента качества сертифицирована по Международному стандарту ISO 9001;
- При необходимости вся продукция военного и аэрокосмического назначения проходит испытания и сертификацию в лаборатории (по согласованию с заказчиком);
- Поставка специализированных компонентов военного и аэрокосмического уровня качества (Xilinx, Altera, Analog Devices, Intersil, Interpoint, Microsemi, Actel, Aeroflex, Peregrine, VPT, Syfer, Eurofarad, Texas Instruments, MS Kennedy, Miteq, Cobham, E2V, MA-COM, Hittite, Mini-Circuits, General Dynamics и др.);

Компания «Океан Электроники» является официальным дистрибьютором и эксклюзивным представителем в России одного из крупнейших производителей разъемов военного и аэрокосмического назначения «JONHON», а так же официальным дистрибьютором и эксклюзивным представителем в России производителя высокотехнологичных и надежных решений для передачи СВЧ сигналов «FORSTAR».



## JONHON

«JONHON» (основан в 1970 г.)

Разъемы специального, военного и аэрокосмического назначения:

(Применяются в военной, авиационной, аэрокосмической, морской, железнодорожной, горно- и нефтедобывающей отраслях промышленности)

«FORSTAR» (основан в 1998 г.)

ВЧ соединители, коаксиальные кабели, кабельные сборки и микроволновые компоненты:

(Применяются в телекоммуникациях гражданского и специального назначения, в средствах связи, РЛС, а так же военной, авиационной и аэрокосмической отраслях промышленности).



Телефон: 8 (812) 309-75-97 (многоканальный)

Факс: 8 (812) 320-03-32

Электронная почта: [ocean@oceanchips.ru](mailto:ocean@oceanchips.ru)

Web: <http://oceanchips.ru/>

Адрес: 198099, г. Санкт-Петербург, ул. Калинина, д. 2, корп. 4, лит. А