

# 2N6052

Preferred Device

## Darlington Complementary Silicon Power Transistors

This package is designed for general-purpose amplifier and low frequency switching applications.

### Features

- High DC Current Gain —  $h_{FE} = 3500$  (Typ) @  $I_C = 5.0$  Adc
- Collector-Emitter Sustaining Voltage — @ 100 mA  
 $V_{CEO(sus)} = 100$  Vdc (Min)
- Monolithic Construction with Built-In Base-Emitter Shunt Resistors
- This is a Pb-Free Device\*

### MAXIMUM RATINGS (Note 1)

Rating	Symbol	Value	Unit
Collector-Emitter Voltage	$V_{CEO}$	100	Vdc
Collector-Base Voltage	$V_{CB}$	100	Vdc
Emitter-Base Voltage	$V_{EB}$	5.0	Vdc
Collector Current - Continuous Peak	$I_C$	12 20	Adc
Base Current	$I_B$	0.2	Adc
Total Power Dissipation @ $T_C = 25^\circ\text{C}$ Derate above $25^\circ\text{C}$	$P_D$	150 0.857	W W/ $^\circ\text{C}$
Operating and Storage Temperature Range	$T_J, T_{stg}$	-65 to +200	$^\circ\text{C}$

### THERMAL CHARACTERISTICS

Characteristic	Symbol	Max	Unit
Thermal Resistance, Junction-to-Case	$R_{\theta JC}$	1.17	$^\circ\text{C/W}$

Stresses exceeding Maximum Ratings may damage the device. Maximum Ratings are stress ratings only. Functional operation above the Recommended Operating Conditions is not implied. Extended exposure to stresses above the Recommended Operating Conditions may affect device reliability.

1. Indicates JEDEC Registered Data.

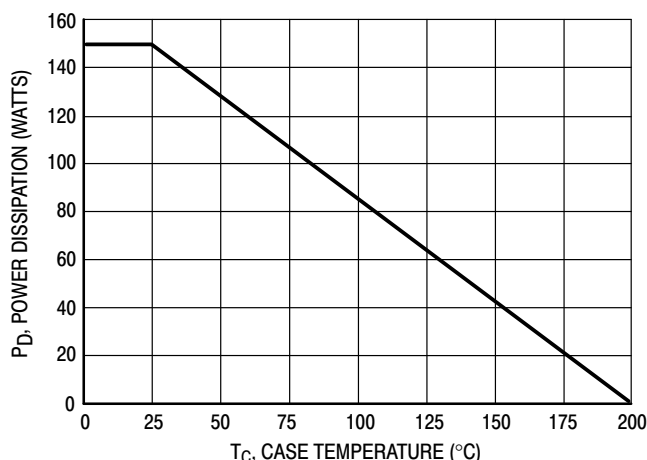

Figure 1. Power Derating



ON Semiconductor®

<http://onsemi.com>

## 12 AMPERE COMPLEMENTARY SILICON POWER TRANSISTOR 100 VOLTS, 150 WATTS

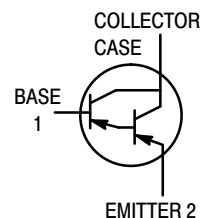

### MARKING DIAGRAM

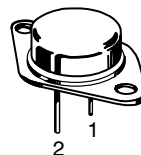

TO-204AA (TO-3)  
CASE 1-07  
STYLE 1

2N6052 = Device Code  
G = Pb-Free Package  
A = Location Code  
YY = Year  
WW = Work Week  
MEX = Country of Origin

### ORDERING INFORMATION

Device	Package	Shipping
2N6052G	TO-3 (Pb-Free)	100 Units/Tray

Preferred devices are recommended choices for future use and best overall value.

\*For additional information on our Pb-Free strategy and soldering details, please download the ON Semiconductor Soldering and Mounting Techniques Reference Manual, SOLDERRM/D.

# 2N6052

## ELECTRICAL CHARACTERISTICS ( $T_C = 25^\circ\text{C}$ unless otherwise noted) (Note 2)

Characteristic	Symbol	Min	Max	Unit	
<b>OFF CHARACTERISTICS</b>					
Collector-Emitter Sustaining Voltage (Note 3)	$(I_C = 100 \text{ mAdc}, I_B = 0)$	$V_{CEO(sus)}$	100	-	Vdc
Collector Cutoff Current	$(V_{CE} = 50 \text{ Vdc}, I_B = 0)$	$I_{CEO}$	-	1.0	mAdc
Collector Cutoff Current	$(V_{CE} = \text{Rated } V_{CEO}, V_{BE(off)} = 1.5 \text{ Vdc})$ $(V_{CE} = \text{Rated } V_{CEO}, V_{BE(off)} = 1.5 \text{ Vdc}, T_C = 150^\circ\text{C})$	$I_{CEX}$	-	0.5 5.0	mAdc
Emitter Cutoff Current	$(V_{BE} = 5.0 \text{ Vdc}, I_C = 0)$	$I_{EBO}$	-	2.0	mAdc
<b>ON CHARACTERISTICS (Note 3)</b>					
DC Current Gain	$(I_C = 6.0 \text{ Adc}, V_{CE} = 3.0 \text{ Vdc})$ $(I_C = 12 \text{ Adc}, V_{CE} = 3.0 \text{ Vdc})$	$h_{FE}$	750 100	18,000 -	-
Collector-Emitter Saturation Voltage	$(I_C = 6.0 \text{ Adc}, I_B = 24 \text{ mAdc})$ $(I_C = 12 \text{ Adc}, I_B = 120 \text{ mAdc})$	$V_{CE(sat)}$	-	2.0 3.0	Vdc
Base-Emitter Saturation Voltage	$(I_C = 12 \text{ Adc}, I_B = 120 \text{ mAdc})$	$V_{BE(sat)}$	-	4.0	Vdc
Base-Emitter On Voltage	$(I_C = 6.0 \text{ Adc}, V_{CE} = 3.0 \text{ Vdc})$	$V_{BE(on)}$	-	2.8	Vdc
<b>DYNAMIC CHARACTERISTICS</b>					
Magnitude of Common Emitter Small-Signal Short Circuit Forward Current Transfer Ratio	$(I_C = 5.0 \text{ Adc}, V_{CE} = 3.0 \text{ Vdc}, f = 1.0 \text{ MHz})$	$ h_{fe} $	4.0	-	MHz
Output Capacitance	$(V_{CB} = 10 \text{ Vdc}, I_E = 0, f = 0.1 \text{ MHz})$	$C_{ob}$	-	500	pF
Small-Signal Current Gain	$(I_C = 5.0 \text{ Adc}, V_{CE} = 3.0 \text{ Vdc}, f = 1.0 \text{ kHz})$	$h_{fe}$	300	-	-

- Indicates JEDEC Registered Data.
- Pulse test: Pulse Width = 300  $\mu\text{s}$ , Duty Cycle = 2.0%.

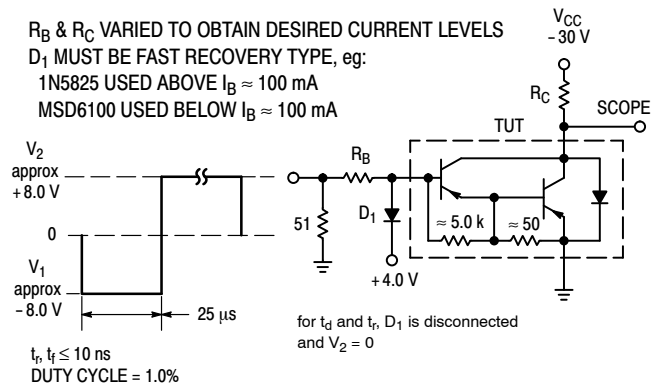

For NPN test circuit reverse diode and voltage polarities.

Figure 2. Switching Times Test Circuit

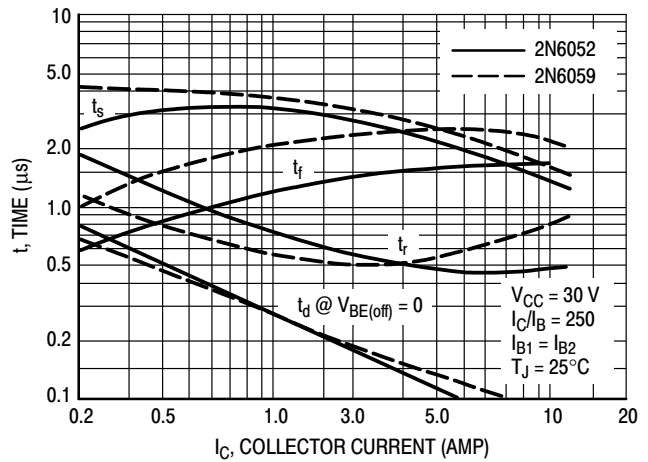

Figure 3. Switching Times

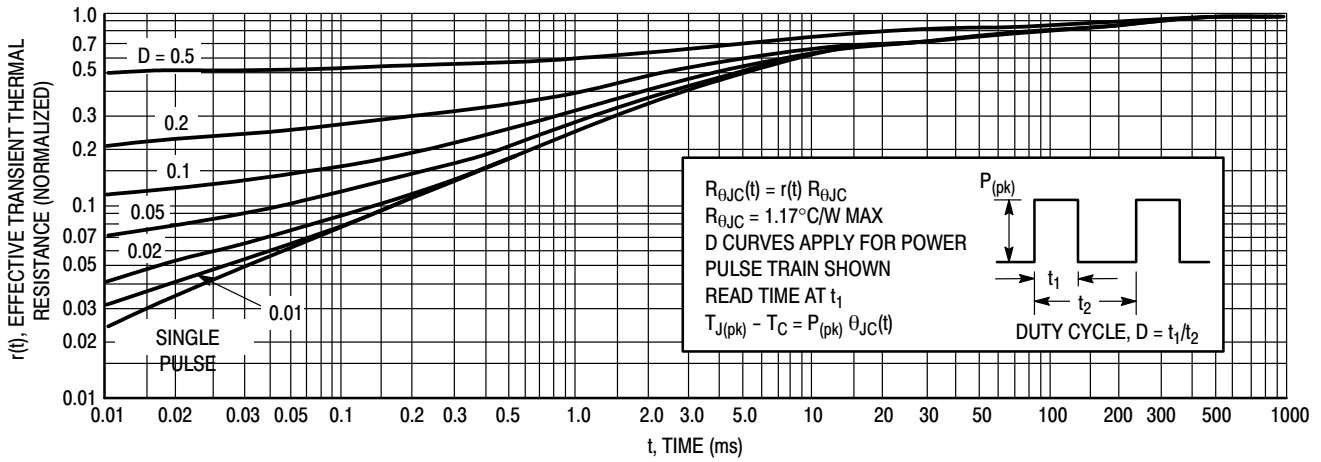

Figure 4. Thermal Response

There are two limitations on the power handling ability of a transistor: average junction temperature and second breakdown. Safe operating area curves indicate  $I_C - V_{CE}$  limits of the transistor that must be observed for reliable operation; i.e., the transistor must not be subjected to greater dissipation than the curves indicate.

The data of Figures 5, and 6 is based on  $T_{J(pk)} = 200^\circ\text{C}$ ;  $T_C$  is variable depending on conditions. Second breakdown pulse limits are valid for duty cycles to 10% provided  $T_{J(pk)} \leq 200^\circ\text{C}$ ;  $T_{J(pk)}$  may be calculated from the data in Figure 4. At high case temperatures, thermal limitations will reduce the power that can be handled to values less than the limitations imposed by second breakdown.

ACTIVE-REGION SAFE OPERATING AREA

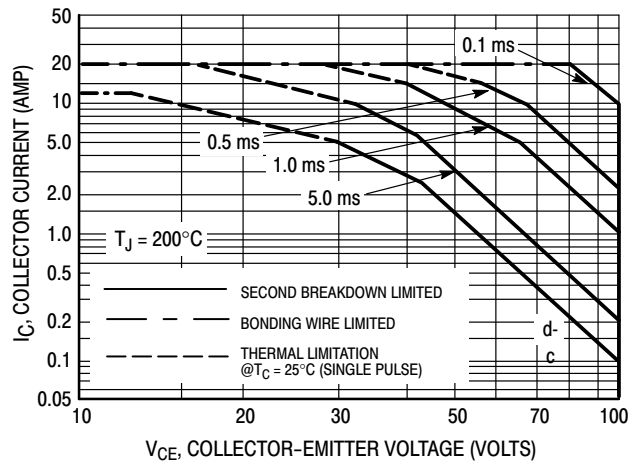

Figure 5.

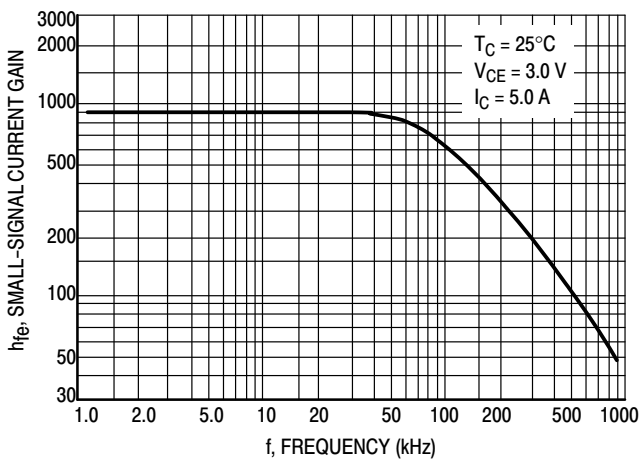

Figure 6. Small-Signal Current Gain

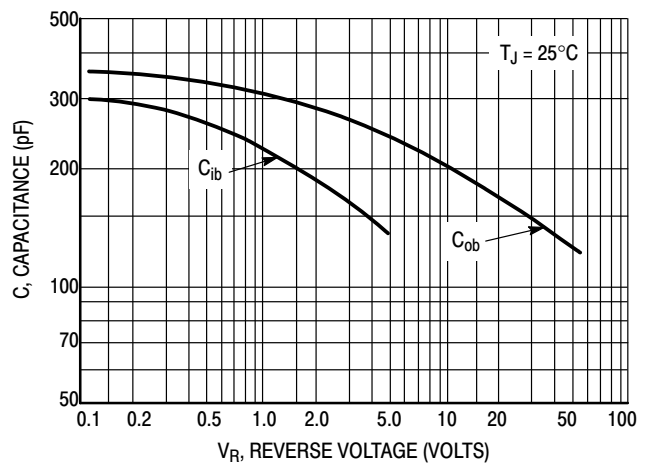

Figure 7. Capacitance

# 2N6052

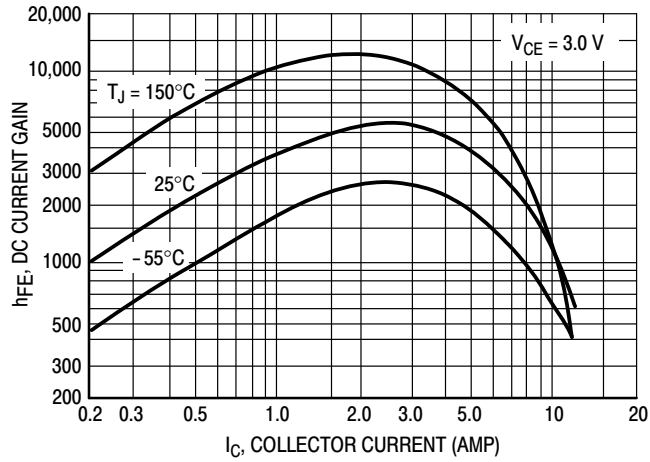

Figure 8. DC Current Gain

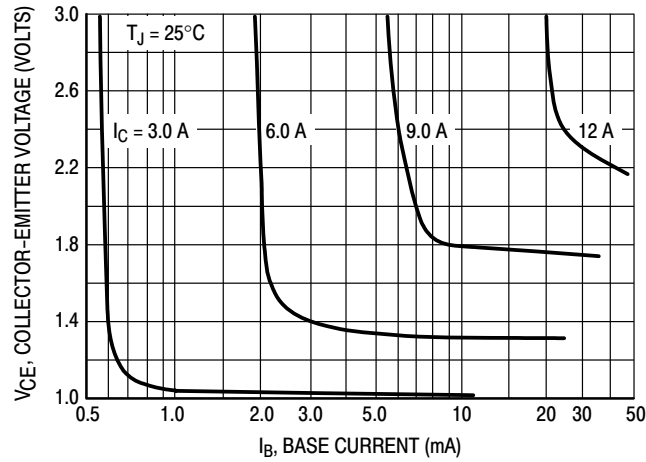

Figure 9. Collector Saturation Region

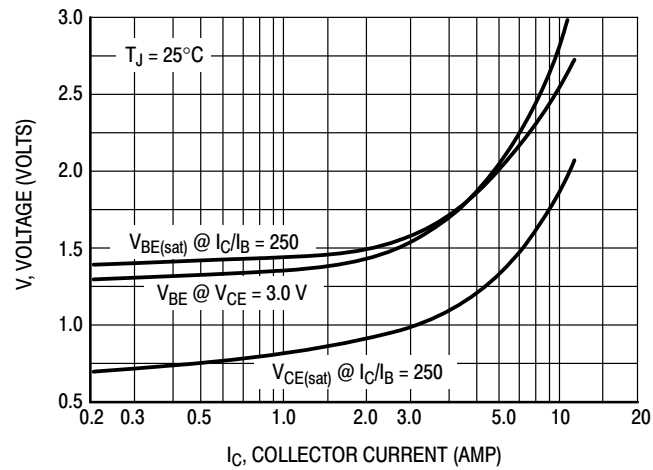
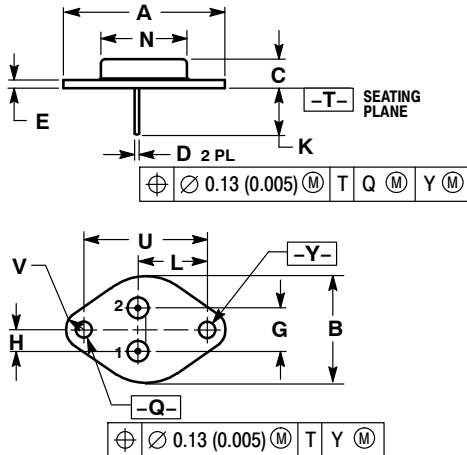

Figure 10. "On" Voltages

# 2N6052

## PACKAGE DIMENSIONS

TO-204 (TO-3)  
CASE 1-07  
ISSUE Z



### NOTES:

1. DIMENSIONING AND TOLERANCING PER ANSI Y14.5M, 1982.
2. CONTROLLING DIMENSION: INCH.
3. ALL RULES AND NOTES ASSOCIATED WITH REFERENCED TO-204AA OUTLINE SHALL APPLY.

DIM	INCHES		MILLIMETERS	
	MIN	MAX	MIN	MAX
A	1.550 REF		39.37 REF	
B	---	1.050	---	26.67
C	0.250	0.335	6.35	8.51
D	0.038	0.043	0.97	1.09
E	0.055	0.070	1.40	1.77
G	0.430 BSC		10.92 BSC	
H	0.215 BSC		5.46 BSC	
K	0.440	0.480	11.18	12.19
L	0.665 BSC		16.89 BSC	
N	---	0.830	---	21.08
Q	0.151	0.165	3.84	4.19
U	1.187 BSC		30.15 BSC	
V	0.131	0.188	3.33	4.77

### STYLE 1:

- PIN 1. BASE
  - EMITTER
- CASE: COLLECTOR

ON Semiconductor and  are registered trademarks of Semiconductor Components Industries, LLC (SCILLC). SCILLC reserves the right to make changes without further notice to any products herein. SCILLC makes no warranty, representation or guarantee regarding the suitability of its products for any particular purpose, nor does SCILLC assume any liability arising out of the application or use of any product or circuit, and specifically disclaims any and all liability, including without limitation special, consequential or incidental damages. "Typical" parameters which may be provided in SCILLC data sheets and/or specifications can and do vary in different applications and actual performance may vary over time. All operating parameters, including "Typicals" must be validated for each customer application by customer's technical experts. SCILLC does not convey any license under its patent rights nor the rights of others. SCILLC products are not designed, intended, or authorized for use as components in systems intended for surgical implant into the body, or other applications intended to support or sustain life, or for any other application in which the failure of the SCILLC product could create a situation where personal injury or death may occur. Should Buyer purchase or use SCILLC products for any such unintended or unauthorized application, Buyer shall indemnify and hold SCILLC and its officers, employees, subsidiaries, affiliates, and distributors harmless against all claims, costs, damages, and expenses, and reasonable attorney fees arising out of, directly or indirectly, any claim of personal injury or death associated with such unintended or unauthorized use, even if such claim alleges that SCILLC was negligent regarding the design or manufacture of the part. SCILLC is an Equal Opportunity/Affirmative Action Employer. This literature is subject to all applicable copyright laws and is not for resale in any manner.

### PUBLICATION ORDERING INFORMATION

#### LITERATURE FULFILLMENT:

Literature Distribution Center for ON Semiconductor  
P.O. Box 5163, Denver, Colorado 80217 USA  
Phone: 303-675-2175 or 800-344-3860 Toll Free USA/Canada  
Fax: 303-675-2176 or 800-344-3867 Toll Free USA/Canada  
Email: orderlit@onsemi.com

N. American Technical Support: 800-282-9855 Toll Free  
USA/Canada  
Europe, Middle East and Africa Technical Support:  
Phone: 421 33 790 2910  
Japan Customer Focus Center  
Phone: 81-3-5773-3850

ON Semiconductor Website: [www.onsemi.com](http://www.onsemi.com)

Order Literature: <http://www.onsemi.com/orderlit>

For additional information, please contact your local Sales Representative

Компания «Океан Электроники» предлагает заключение долгосрочных отношений при поставках импортных электронных компонентов на взаимовыгодных условиях!

Наши преимущества:

- Поставка оригинальных импортных электронных компонентов напрямую с производств Америки, Европы и Азии, а так же с крупнейших складов мира;
- Широкая линейка поставок активных и пассивных импортных электронных компонентов (более 30 млн. наименований);
- Поставка сложных, дефицитных, либо снятых с производства позиций;
- Оперативные сроки поставки под заказ (от 5 рабочих дней);
- Экспресс доставка в любую точку России;
- Помощь Конструкторского Отдела и консультации квалифицированных инженеров;
- Техническая поддержка проекта, помощь в подборе аналогов, поставка прототипов;
- Поставка электронных компонентов под контролем ВП;
- Система менеджмента качества сертифицирована по Международному стандарту ISO 9001;
- При необходимости вся продукция военного и аэрокосмического назначения проходит испытания и сертификацию в лаборатории (по согласованию с заказчиком);
- Поставка специализированных компонентов военного и аэрокосмического уровня качества (Xilinx, Altera, Analog Devices, Intersil, Interpoint, Microsemi, Actel, Aeroflex, Peregrine, VPT, Syfer, Eurofarad, Texas Instruments, MS Kennedy, Miteq, Cobham, E2V, MA-COM, Hittite, Mini-Circuits, General Dynamics и др.);

Компания «Океан Электроники» является официальным дистрибьютором и эксклюзивным представителем в России одного из крупнейших производителей разъемов военного и аэрокосмического назначения «JONHON», а так же официальным дистрибьютором и эксклюзивным представителем в России производителя высокотехнологичных и надежных решений для передачи СВЧ сигналов «FORSTAR».



## JONHON

«JONHON» (основан в 1970 г.)

Разъемы специального, военного и аэрокосмического назначения:

(Применяются в военной, авиационной, аэрокосмической, морской, железнодорожной, горно- и нефтедобывающей отраслях промышленности)

«FORSTAR» (основан в 1998 г.)

ВЧ соединители, коаксиальные кабели, кабельные сборки и микроволновые компоненты:

(Применяются в телекоммуникациях гражданского и специального назначения, в средствах связи, РЛС, а так же военной, авиационной и аэрокосмической отраслях промышленности).



Телефон: 8 (812) 309-75-97 (многоканальный)

Факс: 8 (812) 320-03-32

Электронная почта: [ocean@oceanchips.ru](mailto:ocean@oceanchips.ru)

Web: <http://oceanchips.ru/>

Адрес: 198099, г. Санкт-Петербург, ул. Калинина, д. 2, корп. 4, лит. А