

## Compact, Low-cost, SSR Switching 5 to 20 A

- Wide load voltage range: 75 to 264 VAC. Both 100-V and 200-V loads can be handled with the same model.
- Dedicated, compact aluminum PCB and power elements used.
- Built-in varistor effectively absorbs external surges.
- Quick-connect #110 input terminals and #250 output connections. (#187 input terminals and #250 output connections are available.)
- “-US” models certified by UL, CSA, and IEC/EN (TÜV).



Refer to *Safety Precautions for All Solid State Relays*.



For the most recent information on models that have been certified for safety standards, refer to your OMRON website.

## Model Number Structure

### Model Number Legend

G3NE-□□□□-□-□  
 1      2 3 4 5 6 7

#### 1. Basic Model Name

G3NE: Solid State Relay

#### 2. Rated Load Power Supply Voltage

2: 200 VAC

#### 3. Rated Load Current

05: 5 A

10: 10 A

20: 20 A

#### 4. Terminal Type

T: Quick-connect terminals

#### 5. Zero Cross Function

Blank: Equipped with zero cross function

L: Not equipped with zero cross function

#### 6. Special Specifications

Blank: Standard models

2: #187 input terminals

#### 7. Certification

US: Certified by UL, CSA, and TÜV

# Ordering Information

## ■ List of Models

Isolation	Zero cross function	Indicator	Rated output load	Rated input voltage (See note 1, 2.)	Model		
Phototriac	Yes	No	5 A at 100 to 240 VAC	5VDC	G3NE-205T-US DC5 G3NE-205T-2-US DC5		
				12VDC	G3NE-205T-US DC12 G3NE-205T-2-US DC12		
				24VDC	G3NE-205T-US DC24 G3NE-205T-2-US DC24		
			10 A at 100 to 240 VAC	5VDC	G3NE-210T-US DC5 G3NE-210T-2-US DC5		
				12VDC	G3NE-210T-US DC12 G3NE-210T-2-US DC12		
				24VDC	G3NE-210T-US DC24 G3NE-210T-2-US DC24		
			20 A at 100 to 240 VAC	5VDC	G3NE-220T-US DC5 G3NE-220T-2-US DC5		
				12VDC	G3NE-220T-US DC12 G3NE-220T-2-US DC12		
				24VDC	G3NE-220T-US DC24 G3NE-220T-2-US DC24		
			No	No	5 A at 100 to 240 VAC	5VDC	G3NE-205TL-US DC5 G3NE-205TL-2-US DC5
						12VDC	G3NE-205TL-US DC12 G3NE-205TL-2-US DC12
						24VDC	G3NE-205TL-US DC24 G3NE-205TL-2-US DC24
	10 A at 100 to 240 VAC	5VDC			G3NE-210TL-US DC5 G3NE-210TL-2-US DC5		
		12VDC			G3NE-210TL-US DC12 G3NE-210TL-2-US DC12		
		24VDC			G3NE-210TL-US DC24 G3NE-210TL-2-US DC24		
	20 A at 100 to 240 VAC	5VDC			G3NE-220TL-US DC5 G3NE-220TL-2-US DC5		
		12VDC			G3NE-220TL-US DC12 G3NE-220TL-2-US DC12		
		24VDC			G3NE-220TL-US DC24 G3NE-220TL-2-US DC24		

- Note:** 1. The rated input voltage depends on the ambient temperature. For details, refer to *Load Current vs. Ambient Temperature* in *Engineering Data* on page 4.  
 2. When ordering, specify the input voltage.  
 3. Refer to *List of Certified Models* for a list of products that comply with safety standards. When ordering a UL, CSA, and EN(TÜV) certified model, add "-US" to the model number.

## ■ Accessories (Order Separately)

### One-touch Mounting Plates

Model	Applicable SSR
R99-12 FOR G3NA	G3NE

### Heat Sinks

The following heat sinks are thin and can be DIN-track mounted.  
 See *Dimensions* for details.

Model	Applicable SSR
Y92B-N50	G3NE-205T(L)(-2)-US/-210T(L)(-2)-US
Y92B-N100	G3NE-220T(L)(-2)-US

# Specifications

## ■ Ratings (at an Ambient Temperature of 25°C)

### Input

Rated voltage	Operating voltage	Voltage level		Input impedance	
		Must operate	Must release	With zero cross function	Without zero cross function
5 VDC	4 to 6 VDC	4 VDC max.	1 VDC min.	250 Ω±20%	300 Ω±20%
12 VDC	9.6 to 14.4 VDC	9.6 VDC max.		600 Ω±20%	800 Ω±20%
24 VDC	19.2 to 28.8 VDC	19.2 VDC max.		1.6 kΩ±20%	

**Note:** Each model has 5-VDC, 12-VDC, and 24-VDC input versions.

### Output

Model	Applicable load				
	Rated load voltage	Load voltage range	Load current (See note 1.)		Inrush current
			With heat sink	Without heat sink	
G3NE-205T(L)(-2)-US	100 to 240 VAC	75 to 264 VAC	0.1 to 5 A at 40°C	0.1 to 5 A at 40°C	60 A (60 Hz, 1 cycle)
G3NE-210T(L)(-2)-US			0.1 to 10 A at 40°C (See note 2.)	0.1 to 5 A at 40°C	150 A (60 Hz, 1 cycle)
G3NE-220T(L)(-2)-US			0.1 to 20 A at 40°C (See note 2.)	0.1 to 5 A at 40°C	220 A (60 Hz, 1 cycle)

**Note:** 1. The load current varies depending on the ambient temperature. Refer to *Load Current vs. Ambient Temperature* under *Engineering Data* for details on page 4.

2. These values apply when using a dedicated heat sink or a radiation plate of specified size.

## ■ Characteristics

Item	G3NE-2□□T(-2)-US	G3NE-2□□TL(-2)-US
Operate time	1/2 of load power source cycle + 1 ms max.	1 ms max.
Release time	1/2 of load power source cycle + 1 ms max.	
Output ON voltage drop	1.6 V (RMS) max.	
Leakage current	2 mA max. (at 100 VAC) 5 mA max. (at 200 VAC)	
Insulation resistance	100 MΩ min. (at 500 VDC)	
Dielectric strength	2,000 VAC, 50/60 Hz for 1 min	
Vibration resistance	Destruction: 10 to 55 to 10 Hz, 0.75-mm single amplitude	
Shock resistance	Destruction: 1,000 m/s <sup>2</sup>	
Ambient temperature	Operating: -30°C to 80°C (with no icing or condensation) Storage: -30°C to 100°C (with no icing or condensation)	
Ambient humidity	Operating: 45% to 85%	
Certified standards	UL508 File No. E64562/CSA C22.2 (No.0, No.14) File No. LR35535 TÜV R9051064 (VDE0435) (EN60950)	
EMC	Emission: EN55011 Group 1 Class B Immunity: EN61000-6-2	
Weight	Approx. 37 g	

# Engineering Data

## Load Current vs. Ambient Temperature

G3NE-205T(L)(-2)-US

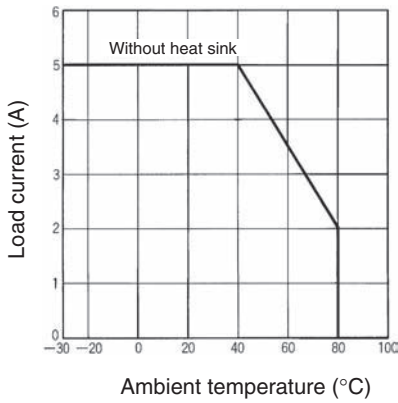

G3NE-210T(L)(-2)-US

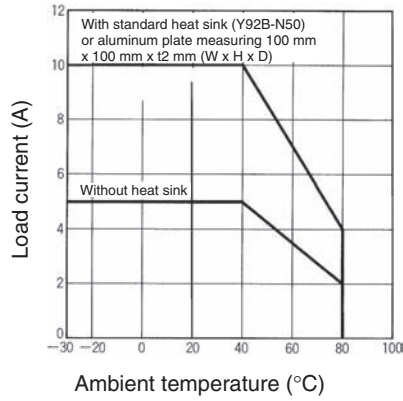

G3NE-220T(L)(-2)-US

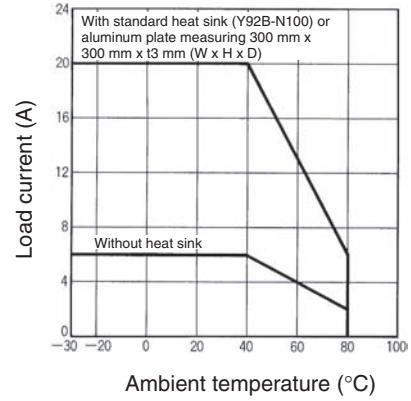

## One Cycle Surge Current: Non-repetitive

Note: Keep the inrush current to half the rated value if it occurs repetitively.

G3NE-205T(L)(-2)-US

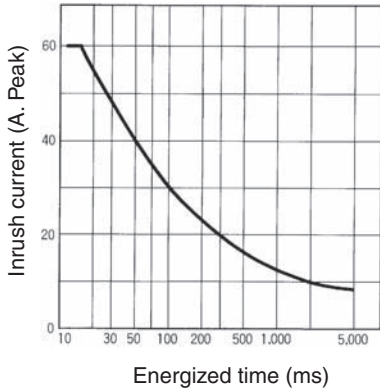

G3NE-210T(L)(-2)-US



G3NE-220T(L)(-2)-US

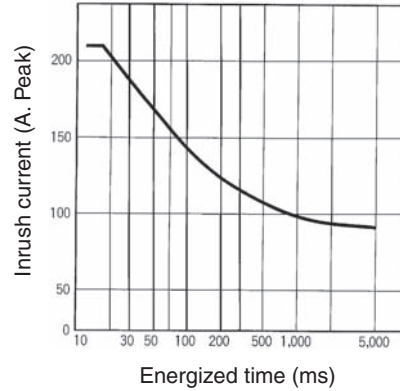

# Dimensions

Note: All units are in millimeters unless otherwise indicated.

## G3NE-205T(L)/210T(L)/220T(L)-2-US

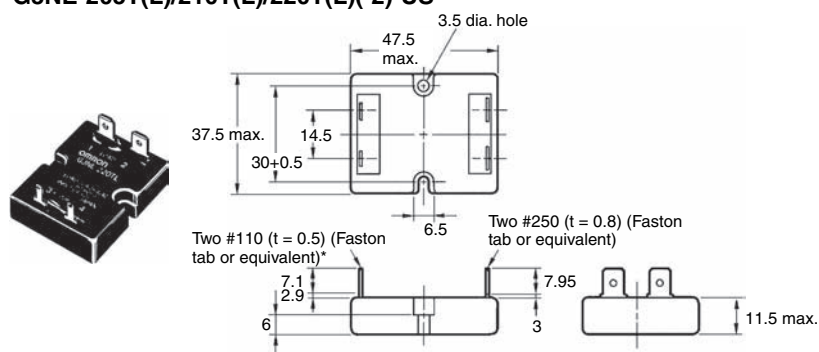

\* G3NE-2□□T(L)-2-US: Two, #187 (t=0.5) (Faston tab or equivalent)

### Terminal Arrangement/ Internal Connections (Top View)

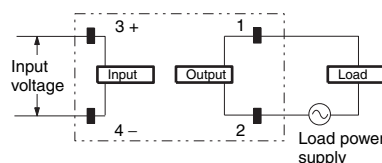

### Mounting Holes

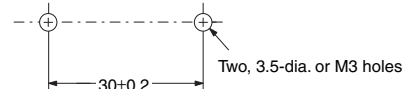

## Heat Sink Y92B-N50

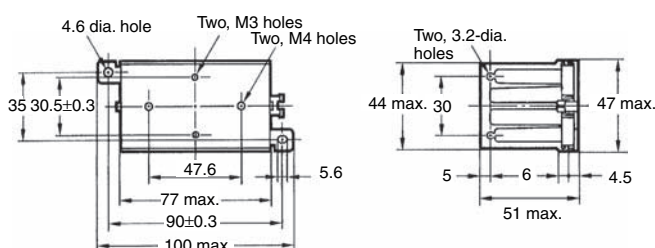

### Mounting Holes

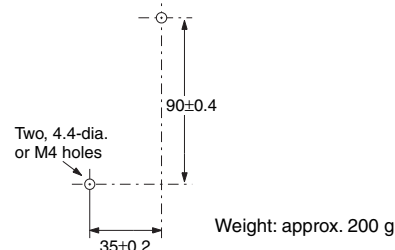

Weight: approx. 200 g

## Y92B-N100

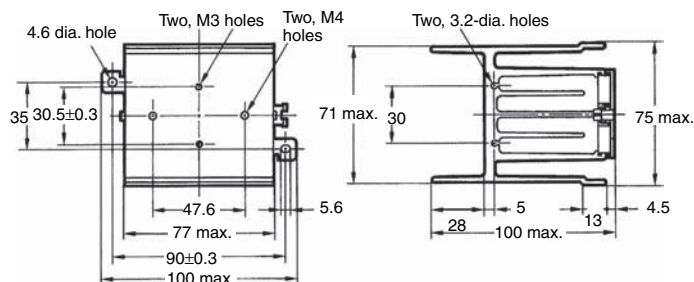

### Mounting Holes

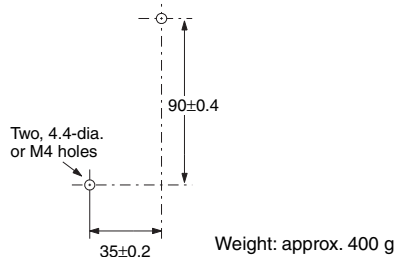

Weight: approx. 400 g

# Safety Precautions

Refer to *Safety Precautions for All Solid State Relays*.

## ■ Precautions for Correct Use

Please observe the following precautions to prevent failure to operate, malfunction, or undesirable effect on product performance.

Do not apply excessive force to the terminals. Be careful when pulling or inserting the terminal clips for the Quick Connector (QC).

When attaching a heat sink to the G3NE, in order to facilitate heat dissipation, apply heat-conductive grease on the heat sink.

For DIN Track mounting, use a separately sold Heat Sink. Refer to information on the G3NA.

G3NE-210T(L): Y92B-N50

G3NE-220T(L): Y92B-N100

Tighten the mounting screws of the heat sink with a torque of 0.59 to 0.98 N·m.

## ■ Thermal Resistance Rth (Back of Junction SSR)

Model	Thermal resistance (°C/W)
G3NE-205T (L)	2.72
G3NE-210T (L)	2.12
G3NE-220T (L)	2.22

## ■ EMC Directive Compliance

The G3NE complies with EMC Directives under the following conditions ("-US" models only).

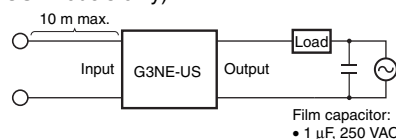

- Connect a film capacitor to the load power supply.
- The input cable must be less than 10 m.

ALL DIMENSIONS SHOWN ARE IN MILLIMETERS.  
To convert millimeters into inches, multiply by 0.03937. To convert grams into ounces, multiply by 0.03527.

In the interest of product improvement, specifications are subject to change without notice.

## Terms and Conditions Agreement

### Read and understand this catalog.

Please read and understand this catalog before purchasing the products. Please consult your OMRON representative if you have any questions or comments.

### Warranties.

(a) Exclusive Warranty. Omron's exclusive warranty is that the Products will be free from defects in materials and workmanship for a period of twelve months from the date of sale by Omron (or such other period expressed in writing by Omron). Omron disclaims all other warranties, express or implied.

(b) Limitations. OMRON MAKES NO WARRANTY OR REPRESENTATION, EXPRESS OR IMPLIED, ABOUT NON-INFRINGEMENT, MERCHANTABILITY OR FITNESS FOR A PARTICULAR PURPOSE OF THE PRODUCTS. BUYER ACKNOWLEDGES THAT IT ALONE HAS DETERMINED THAT THE PRODUCTS WILL SUITABLY MEET THE REQUIREMENTS OF THEIR INTENDED USE.

Omron further disclaims all warranties and responsibility of any type for claims or expenses based on infringement by the Products or otherwise of any intellectual property right. (c) Buyer Remedy. Omron's sole obligation hereunder shall be, at Omron's election, to (i) replace (in the form originally shipped with Buyer responsible for labor charges for removal or replacement thereof) the non-complying Product, (ii) repair the non-complying Product, or (iii) repay or credit Buyer an amount equal to the purchase price of the non-complying Product; provided that in no event shall Omron be responsible for warranty, repair, indemnity or any other claims or expenses regarding the Products unless Omron's analysis confirms that the Products were properly handled, stored, installed and maintained and not subject to contamination, abuse, misuse or inappropriate modification. Return of any Products by Buyer must be approved in writing by Omron before shipment. Omron Companies shall not be liable for the suitability or unsuitability or the results from the use of Products in combination with any electrical or electronic components, circuits, system assemblies or any other materials or substances or environments. Any advice, recommendations or information given orally or in writing, are not to be construed as an amendment or addition to the above warranty.

See <http://www.omron.com/global/> or contact your Omron representative for published information.

### Limitation on Liability; Etc.

OMRON COMPANIES SHALL NOT BE LIABLE FOR SPECIAL, INDIRECT, INCIDENTAL, OR CONSEQUENTIAL DAMAGES, LOSS OF PROFITS OR PRODUCTION OR COMMERCIAL LOSS IN ANY WAY CONNECTED WITH THE PRODUCTS, WHETHER SUCH CLAIM IS BASED IN CONTRACT, WARRANTY, NEGLIGENCE OR STRICT LIABILITY.

Further, in no event shall liability of Omron Companies exceed the individual price of the Product on which liability is asserted.

### Suitability of Use.

Omron Companies shall not be responsible for conformity with any standards, codes or regulations which apply to the combination of the Product in the Buyer's application or use of the Product. At Buyer's request, Omron will provide applicable third party certification documents identifying ratings and limitations of use which apply to the Product. This information by itself is not sufficient for a complete determination of the suitability of the Product in combination with the end product, machine, system, or other application or use. Buyer shall be solely responsible for determining appropriateness of the particular Product with respect to Buyer's application, product or system. Buyer shall take application responsibility in all cases.

NEVER USE THE PRODUCT FOR AN APPLICATION INVOLVING SERIOUS RISK TO LIFE OR PROPERTY OR IN LARGE QUANTITIES WITHOUT ENSURING THAT THE SYSTEM AS A WHOLE HAS BEEN DESIGNED TO ADDRESS THE RISKS, AND THAT THE OMRON PRODUCT(S) IS PROPERLY RATED AND INSTALLED FOR THE INTENDED USE WITHIN THE OVERALL EQUIPMENT OR SYSTEM.

### Programmable Products.

Omron Companies shall not be responsible for the user's programming of a programmable Product, or any consequence thereof.

### Performance Data.

Data presented in Omron Company websites, catalogs and other materials is provided as a guide for the user in determining suitability and does not constitute a warranty. It may represent the result of Omron's test conditions, and the user must correlate it to actual application requirements. Actual performance is subject to the Omron's Warranty and Limitations of Liability.

### Change in Specifications.

Product specifications and accessories may be changed at any time based on improvements and other reasons. It is our practice to change part numbers when published ratings or features are changed, or when significant construction changes are made. However, some specifications of the Product may be changed without any notice. When in doubt, special part numbers may be assigned to fix or establish key specifications for your application. Please consult with your Omron's representative at any time to confirm actual specifications of purchased Product.

### Errors and Omissions.

Information presented by Omron Companies has been checked and is believed to be accurate; however, no responsibility is assumed for clerical, typographical or proofreading errors or omissions.

2017.4

In the interest of product improvement, specifications are subject to change without notice.

**OMRON Corporation**  
Industrial Automation Company

<http://www.ia.omron.com/>

(c)Copyright OMRON Corporation 2017 All Right Reserved.

# Mouser Electronics

Authorized Distributor

Click to View Pricing, Inventory, Delivery & Lifecycle Information:

## Omron:

[G3NE-220T-US-DC5](#) [G3NE-210T-US-DC5](#) [G3NE-220T-US-DC24](#) [G3NE-220T-US-DC12](#) [G3NE-210T-US-DC12](#)  
[G3NE-210T-US-DC24](#) [G3NE-205TL-US DC5](#) [G3NE-205T-US DC12](#) [G3NE-205T-US DC24](#) [G3NE-210TL-US DC24](#)  
[G3NE-210TL-US DC5](#) [G3NE-220TL-US DC12](#) [G3NE-220TL-US DC5](#) [G3NE-205T DC12](#) [G3NE-210T-DC12](#) [G3NE-](#)  
[220T-2-US DC5](#) [G3NE-220T-DC12](#) [G3NE-205T-US-DC5](#) [G3NE-210T-2-US DC5](#) [G3NE-220TL-US-DC24](#) [G3NE-](#)  
[210TL-2-US DC24](#) [G3NE-205TL-US DC24](#)



Компания «Океан Электроники» предлагает заключение долгосрочных отношений при поставках импортных электронных компонентов на взаимовыгодных условиях!

Наши преимущества:

- Поставка оригинальных импортных электронных компонентов напрямую с производств Америки, Европы и Азии, а так же с крупнейших складов мира;
- Широкая линейка поставок активных и пассивных импортных электронных компонентов (более 30 млн. наименований);
- Поставка сложных, дефицитных, либо снятых с производства позиций;
- Оперативные сроки поставки под заказ (от 5 рабочих дней);
- Экспресс доставка в любую точку России;
- Помощь Конструкторского Отдела и консультации квалифицированных инженеров;
- Техническая поддержка проекта, помощь в подборе аналогов, поставка прототипов;
- Поставка электронных компонентов под контролем ВП;
- Система менеджмента качества сертифицирована по Международному стандарту ISO 9001;
- При необходимости вся продукция военного и аэрокосмического назначения проходит испытания и сертификацию в лаборатории (по согласованию с заказчиком);
- Поставка специализированных компонентов военного и аэрокосмического уровня качества (Xilinx, Altera, Analog Devices, Intersil, Interpoint, Microsemi, Actel, Aeroflex, Peregrine, VPT, Syfer, Eurofarad, Texas Instruments, MS Kennedy, Miteq, Cobham, E2V, MA-COM, Hittite, Mini-Circuits, General Dynamics и др.);

Компания «Океан Электроники» является официальным дистрибьютором и эксклюзивным представителем в России одного из крупнейших производителей разъемов военного и аэрокосмического назначения «JONHON», а так же официальным дистрибьютором и эксклюзивным представителем в России производителя высокотехнологичных и надежных решений для передачи СВЧ сигналов «FORSTAR».



## JONHON

«JONHON» (основан в 1970 г.)

Разъемы специального, военного и аэрокосмического назначения:

(Применяются в военной, авиационной, аэрокосмической, морской, железнодорожной, горно- и нефтедобывающей отраслях промышленности)

«FORSTAR» (основан в 1998 г.)

ВЧ соединители, коаксиальные кабели, кабельные сборки и микроволновые компоненты:

(Применяются в телекоммуникациях гражданского и специального назначения, в средствах связи, РЛС, а так же военной, авиационной и аэрокосмической отраслях промышленности).



Телефон: 8 (812) 309-75-97 (многоканальный)

Факс: 8 (812) 320-03-32

Электронная почта: [ocean@oceanchips.ru](mailto:ocean@oceanchips.ru)

Web: <http://oceanchips.ru/>

Адрес: 198099, г. Санкт-Петербург, ул. Калинина, д. 2, корп. 4, лит. А