

## High side current sense amplifier

### Features

- Independent supply and input common-mode voltages
- Wide common-mode operating range: 2.8 to 30 V
- Wide common-mode surviving range: -0.3 to 60 V (load-dump)
- Wide supply voltage range: 4 to 24 V
- Low current consumption:  $I_{CC}$  max = 300  $\mu$ A
- Internally fixed gain: 20 V/V, 50 V/V or 100 V/V
- Buffered output

### Applications

- Automotive current monitoring
- Notebook computers
- DC motor controls
- Photovoltaic systems
- Battery chargers
- Precision current sources

### Description

The TSC101 measures a small differential voltage on a high-side shunt resistor and translates it into a ground-referenced output voltage. The gain is internally fixed.

Wide input common-mode voltage range, low quiescent current, and tiny SOT23 packaging enable use in a wide variety of applications.

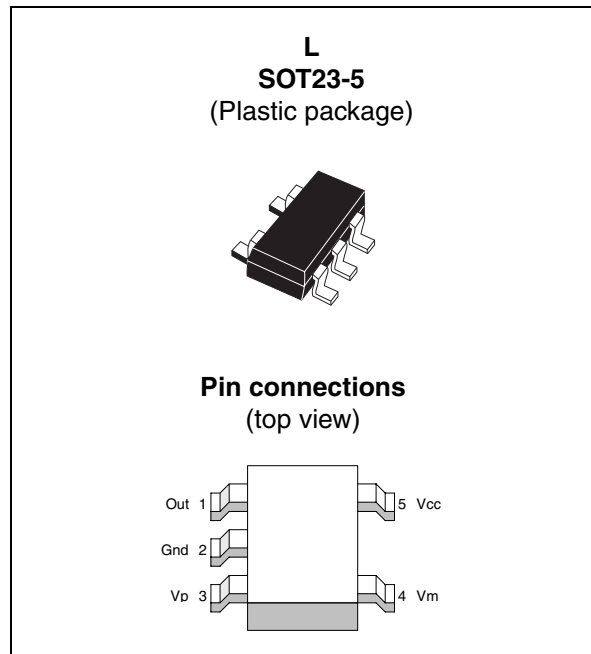

The input common-mode and power supply voltages are independent. The common-mode voltage can range from 2.8 to 30 V in operating conditions and up to 60 V in absolute maximum rating conditions.

The current consumption below 300  $\mu$ A and the wide supply voltage range enable the power supply to be connected to either side of the current measurement shunt with minimal error.

# 1 Application schematics and pin description

The TSC101 high-side current sense amplifier features a 2.8 to 30 V input common-mode range that is independent of the supply voltage. The main advantage of this feature is that it allows high-side current sensing at voltages much greater than the supply voltage ( $V_{CC}$ ).

**Figure 1. Application schematics**

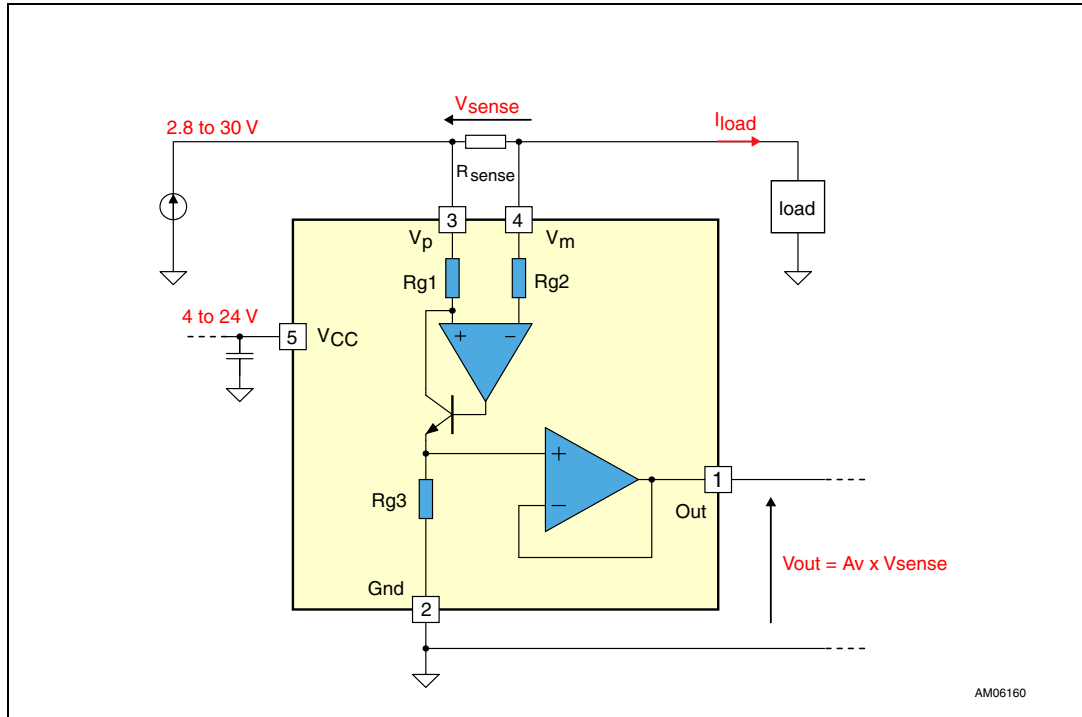

Table 1 describes the function of each pin. The pin positions are shown in the illustration on the cover page and in Figure 1 above.

**Table 1. Pin descriptions**

Symbol	Type	Function
Out	Analog output	Output voltage, proportional to the magnitude of the sense voltage $V_p - V_m$ .
Gnd	Power supply	Ground line
$V_{CC}$	Power supply	Positive power supply line
$V_p$	Analog input	Connection for the external sense resistor. The measured current enters the shunt on the $V_p$ side.
$V_m$	Analog input	Connection for the external sense resistor. The measured current exits the shunt on the $V_m$ side.

## 2 Absolute maximum ratings and operating conditions

**Table 2. Absolute maximum ratings**

Symbol	Parameter	Value	Unit
$V_{id}$	Input pins differential voltage ( $V_p - V_m$ )	$\pm 60$	V
$V_i$	Input pin voltages ( $V_p$ and $V_m$ ) <sup>(1)</sup>	-0.3 to 60	V
$V_{CC}$	DC supply voltage <sup>(1)</sup>	-0.3 to 25	V
$V_{out}$	DC output pin voltage <sup>(1)</sup>	-0.3 to $V_{CC}$	V
$T_{stg}$	Storage temperature	-55 to 150	°C
$T_j$	Maximum junction temperature	150	°C
$R_{thja}$	SOT23-5 thermal resistance junction to ambient	250	°C/W
ESD	HBM: human body model <sup>(2)</sup>	2.5	kV
	MM: machine model <sup>(3)</sup>	150	V
	CDM: charged device model <sup>(4)</sup>	1.5	kV

1. Voltage values are measured with respect to the ground pin.
2. Human body model: a 100 pF capacitor is charged to the specified voltage, then discharged through a 1.5k $\Omega$  resistor between two pins of the device. This is done for all couples of connected pin combinations while the other pins are floating.
3. Machine model: a 200 pF capacitor is charged to the specified voltage, then discharged directly between two pins of the device with no external series resistor (internal resistor < 5  $\Omega$ ). This is done for all couples of connected pin combinations while the other pins are floating.
4. Charged device model: all pins plus package are charged together to the specified voltage and then discharged directly to the ground.

**Table 3. Operating conditions**

Symbol	Parameter	Value	Unit
$V_{CC}$	DC supply voltage from $T_{min}$ to $T_{max}$	4.0 to 24	V
$T_{oper}$	Operational temperature range ( $T_{min}$ to $T_{max}$ )	-40 to 125	°C
$V_{icm}$	Common mode voltage range	2.8 to 30	V

### 3 Electrical characteristics

**Table 4. Supply<sup>(1)</sup>**

Symbol	Parameter	Test conditions	Min.	Typ.	Max.	Unit
$I_{CC}$	Total supply current	$V_{sense} = 0\text{ V}$ $T_{min} < T_{amb} < T_{max}$		165	300	$\mu\text{A}$

1. Unless otherwise specified, the test conditions are  $T_{amb} = 25^\circ\text{C}$ ,  $V_{CC} = 12\text{ V}$ ,  $V_{sense} = V_p - V_m = 50\text{ mV}$ ,  $V_m = 12\text{ V}$ , no load on Out.

**Table 5. Input<sup>(1)</sup>**

Symbol	Parameter	Test conditions	Min.	Typ.	Max.	Unit
CMR	Common mode rejection Variation of $V_{out}$ versus $V_{icm}$ referred to input <sup>(2)</sup>	$2.8\text{ V} < V_{icm} < 30\text{ V}$ $T_{min} < T_{amb} < T_{max}$	90	105		dB
SVR	Supply voltage rejection Variation of $V_{out}$ versus $V_{CC}$ <sup>(3)</sup>	$4.0\text{ V} < V_{CC} < 24\text{ V}$ $V_{sense} = 30\text{ mV}$ $T_{min} < T_{amb} < T_{max}$	90	105		dB
$V_{os}$	Input offset voltage <sup>(4)</sup>	$T_{amb} = 25^\circ\text{C}$ $T_{min} < T_{amb} < T_{max}$		$\pm 0.2$ $\pm 0.9$	$\pm 1.5$ $\pm 2.3$	mV
$dV_{os}/dT$	Input offset drift vs. T	$T_{min} < T_{amb} < T_{max}$		-3		$\mu\text{V}/^\circ\text{C}$
$I_{lk}$	Input leakage current	$V_{CC} = 0\text{ V}$ $T_{min} < T_{amb} < T_{max}$			1	$\mu\text{A}$
$I_{ib}$	Input bias current	$V_{sense} = 0\text{ V}$ $T_{min} < T_{amb} < T_{max}$		5.5	8	$\mu\text{A}$

1. Unless otherwise specified, the test conditions are  $T_{amb} = 25^\circ\text{C}$ ,  $V_{CC} = 12\text{ V}$ ,  $V_{sense} = V_p - V_m = 50\text{ mV}$ ,  $V_m = 12\text{ V}$ , no load on Out.

2. See [Section 4.1: Common mode rejection ratio \(CMR\) on page 11](#) for the definition of CMR.

3. See [Section 4.2: Supply voltage rejection ratio \(SVR\) on page 11](#) for the definition of SVR.

4. See [Section 4.3: Gain \( \$A\_v\$ \) and input offset voltage \( \$V\_{os}\$ \) on page 11](#) for the definition of  $V_{os}$ .

Table 6. Output<sup>(1)</sup>

Symbol	Parameter	Test conditions	Min.	Typ.	Max.	Unit
$A_v$	Gain	TSC101A TSC101B TSC101C		20 50 100		V/V
$\Delta A_v$	Gain accuracy	$T_{amb} = 25^\circ\text{C}$ $T_{min} < T_{amb} < T_{max}$			$\pm 2.5$ $\pm 4.5$	%
$\Delta V_{out}/\Delta T$	Output voltage drift vs. T <sup>(2)</sup>	$T_{min} < T_{amb} < T_{max}$		0.4		mV/°C
$\Delta V_{out}/\Delta I_{out}$	Output stage load regulation	-10 mA < $I_{out}$ < 10 mA $I_{out}$ sink or source current		3	4	mV/mA
$\Delta V_{out}$	Total output voltage accuracy <sup>(3)</sup>	$V_{sense} = 50\text{ mV}$ $T_{amb} = 25^\circ\text{C}$ $T_{min} < T_{amb} < T_{max}$			$\pm 2.5$ $\pm 4.5$	%
$\Delta V_{out}$	Total output voltage accuracy	$V_{sense} = 100\text{ mV}$ $T_{amb} = 25^\circ\text{C}$ $T_{min} < T_{amb} < T_{max}$			$\pm 3.5$ $\pm 5$	%
$\Delta V_{out}$	Total output voltage accuracy	$V_{sense} = 20\text{ mV}$ $T_{amb} = 25^\circ\text{C}$ $T_{min} < T_{amb} < T_{max}$			$\pm 8$ $\pm 11$	%
$\Delta V_{out}$	Total output voltage accuracy	$V_{sense} = 10\text{ mV}$ $T_{amb} = 25^\circ\text{C}$ $T_{min} < T_{amb} < T_{max}$			$\pm 15$ $\pm 20$	%
$I_{sc-sink}$	Short-circuit sink current	Out connected to $V_{CC}$ , $V_{sense} = -1\text{ V}$	30	60		mA
$I_{sc-source}$	Short-circuit source current	Out connected to Gnd $V_{sense} = 1\text{ V}$	15	26		mA
$V_{oh}$	Output stage high-state saturation voltage $V_{oh} = V_{CC} - V_{out}$	$V_{sense} = 1\text{ V}$ $I_{out} = 1\text{ mA}$		0.8	1	V
$V_{ol}$	Output stage low-state saturation voltage	$V_{sense} = -1\text{ V}$ $I_{out} = 1\text{ mA}$		50	100	mV

1. Unless otherwise specified, the test conditions are  $T_{amb} = 25^\circ\text{C}$ ,  $V_{CC} = 12\text{ V}$ ,  $V_{sense} = V_p - V_m = 50\text{ mV}$ ,  $V_m = 12\text{ V}$ , no load on Out.
2. See [Output voltage drift versus temperature on page 12](#) for the definition.
3. Output voltage accuracy is the difference with the expected theoretical output voltage  $V_{out-th} = A_v \cdot V_{sense}$ . See [Output voltage accuracy on page 13](#) for a more detailed definition.

**Table 7. Frequency response<sup>(1)</sup>**

Symbol	Parameter	Test conditions	Min.	Typ.	Max.	Unit
ts	Output settling to 1% final value	V <sub>sense</sub> = 10 mV to 100 mV C <sub>load</sub> = 47 pF <sup>(2)</sup> TSC101A TSC101B TSC101C		3 6 10		μs
SR	Slew rate	V <sub>sense</sub> = 10 mV to 100 mV	0.55	0.9		V/μs
BW	3dB bandwidth	C <sub>load</sub> = 47 pF <sup>(2)</sup> V <sub>sense</sub> = 100 mV TSC101A TSC101B TSC101C		500 670 450		kHz

1. Unless otherwise specified, the test conditions are T<sub>amb</sub> = 25°C, V<sub>CC</sub> = 12 V, V<sub>sense</sub> = V<sub>p</sub>-V<sub>m</sub> = 50 mV, V<sub>m</sub> = 12 V, no load on Out.
2. For stability purposes, we do not recommend using a greater value of load capacitor.

**Table 8. Noise<sup>(1)</sup>**

Symbol	Parameter	Test conditions	Min.	Typ.	Max.	Unit
	Total output voltage noise			50		nV/√Hz

1. Unless otherwise specified, the test conditions are T<sub>amb</sub> = 25°C, V<sub>CC</sub> = 12 V, V<sub>sense</sub> = V<sub>p</sub>-V<sub>m</sub> = 50 mV, V<sub>m</sub> = 12 V, no load on Out.

### 3.1 Electrical characteristics curves

For the following curves, the tested device is a TSC101C, and the test conditions are  $T_{amb} = 25^{\circ}\text{C}$ ,  $V_{CC} = 12\text{ V}$ ,  $V_{sense} = V_p - V_m = 50\text{ mV}$ ,  $V_m = 12\text{ V}$ , no load on Out unless otherwise specified.

**Figure 2. Supply current vs. supply voltage**  
( $V_{sense} = 0\text{ V}$ )

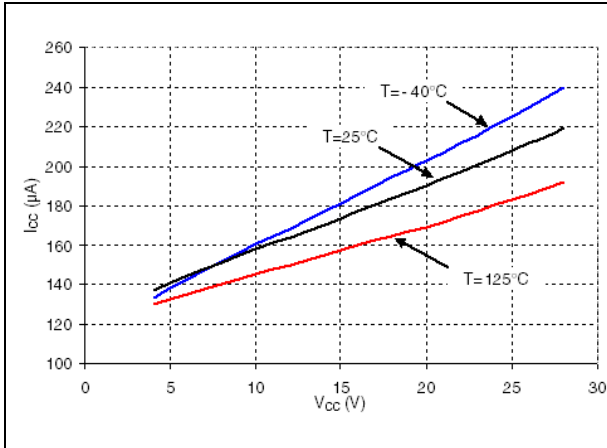

**Figure 3. Supply current vs.  $V_{sense}$**

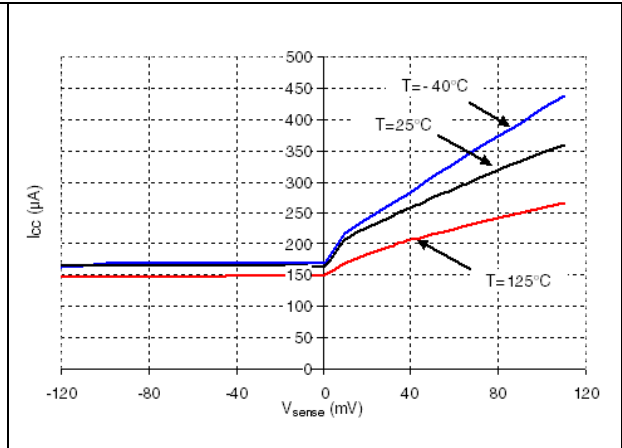

**Figure 4.  $V_p$  pin input bias current vs.  $V_{sense}$**

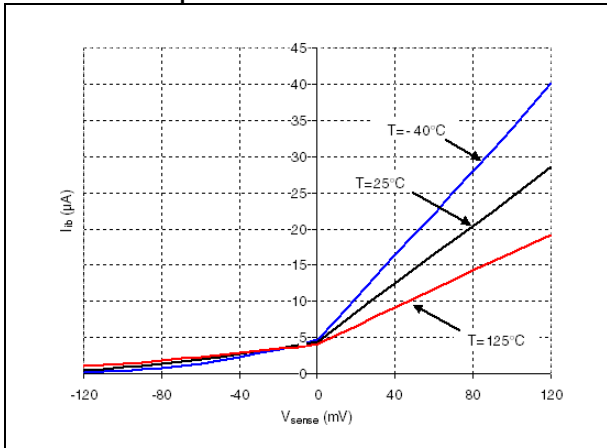

**Figure 5.  $V_m$  pin input bias current vs.  $V_{sense}$**

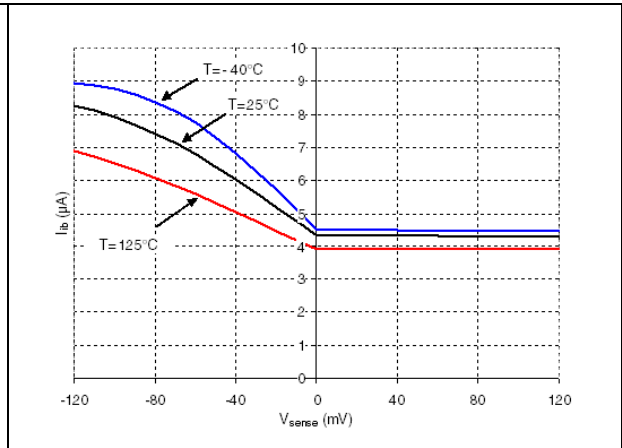

**Figure 6. Minimum common mode operating voltage vs. temperature**

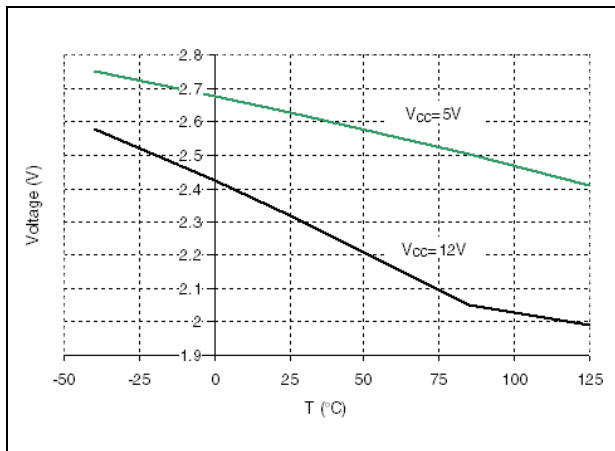

**Figure 7. Output stage low-state saturation voltage versus output current (V<sub>sense</sub> = -1 V)**

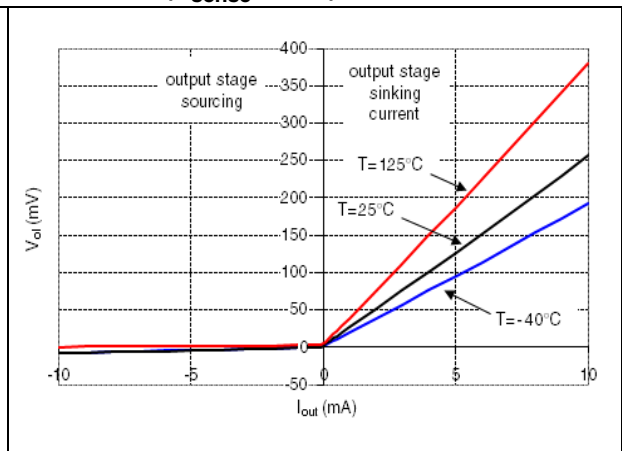

**Figure 8. Output stage high-state saturation voltage versus output current (V<sub>sense</sub> = +1 V)**

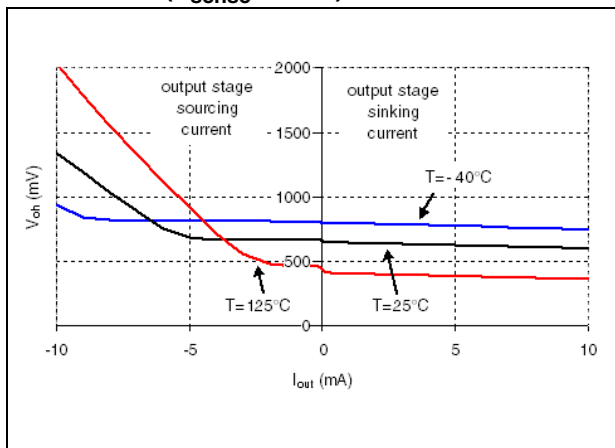

**Figure 9. Output short-circuit source current versus temperature (Out pin connected to ground)**

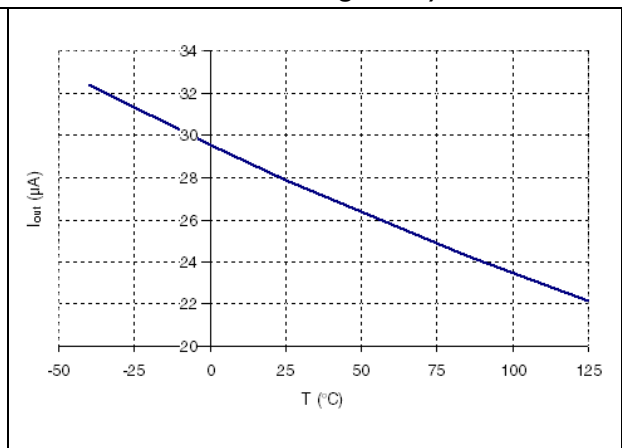



Figure 10. Output short-circuit sink current versus temperature (Out pin connected to  $V_{CC}$ )

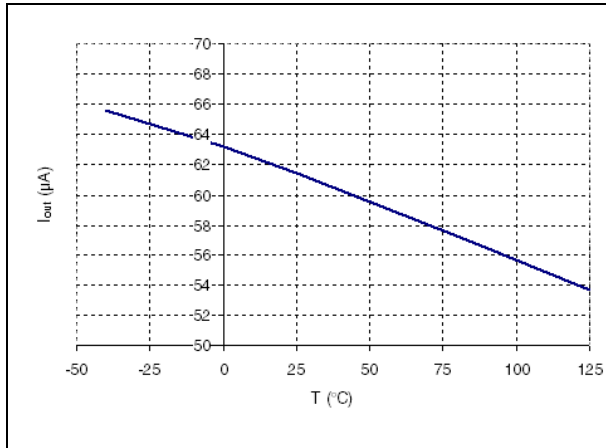

Figure 11. Output stage load regulation

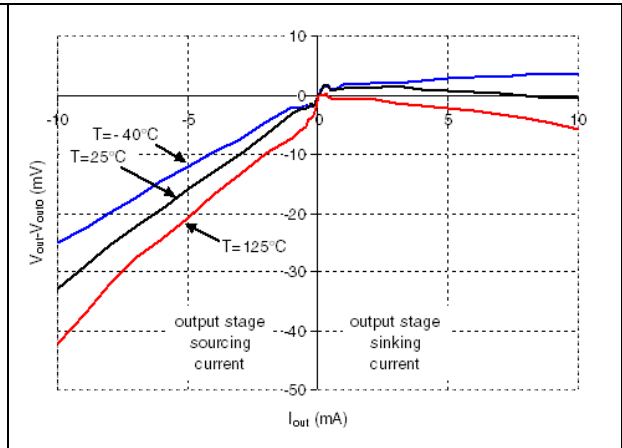

Figure 12. Input offset drift versus temperature

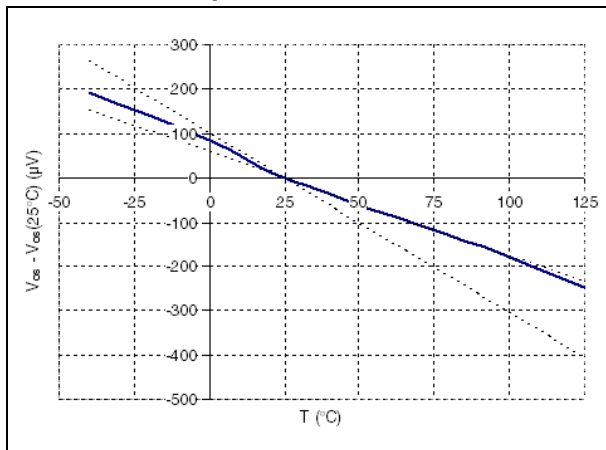

Figure 13. Output voltage drift versus temperature

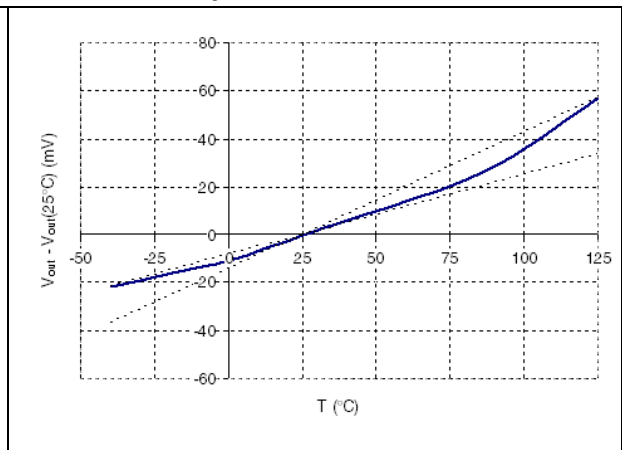

Figure 14. Bode diagram ( $V_{sense}=100mV$ )

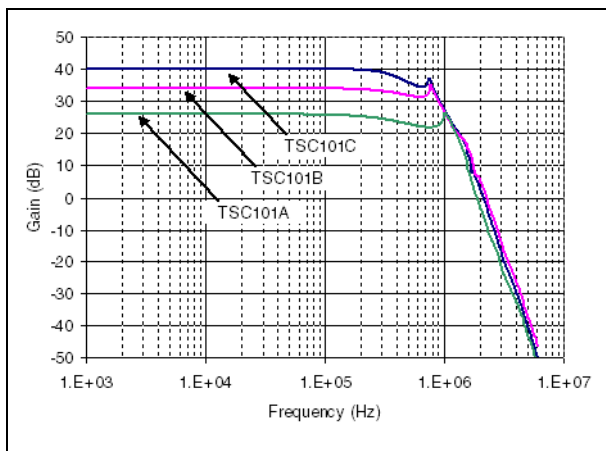

Figure 15. Power-supply rejection ratio versus frequency

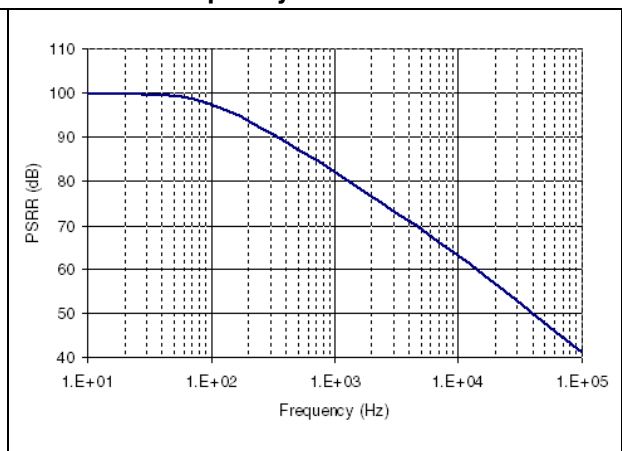

Figure 16. Total output voltage accuracy versus  $V_{sense}$

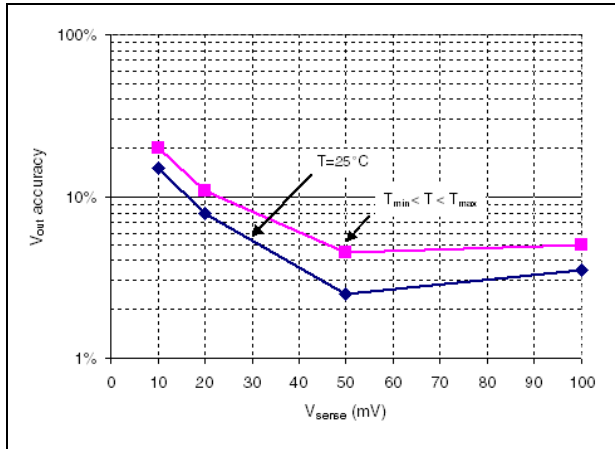

Figure 17. Output voltage versus  $V_{sense}$

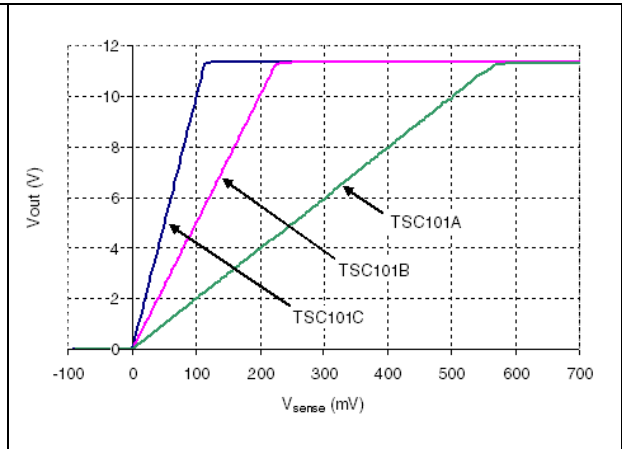
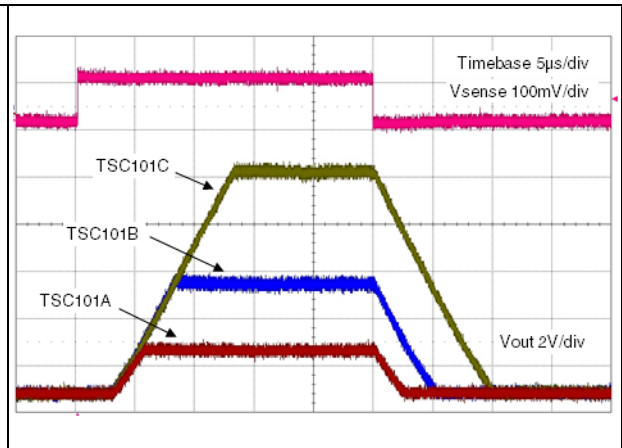
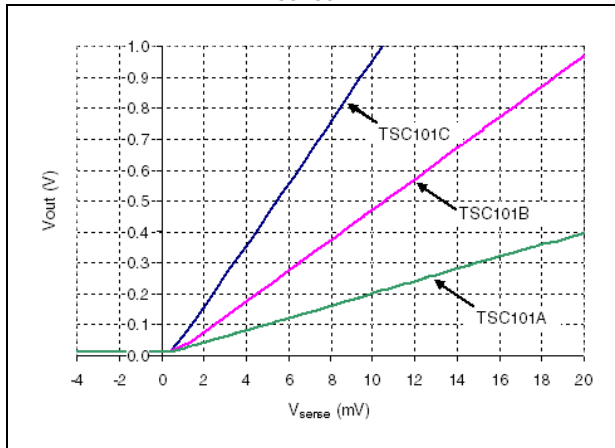

Figure 18. Output voltage versus  $V_{sense}$  (detail for low  $V_{sense}$  values) Figure 19. Step response



## 4 Parameter definitions

### 4.1 Common mode rejection ratio (CMR)

The common-mode rejection ratio (CMR) measures the ability of the current-sensing amplifier to reject any DC voltage applied on both inputs  $V_p$  and  $V_m$ . The CMR is referred back to the input so that its effect can be compared with the applied differential signal. The CMR is defined by the formula:

$$\text{CMR} = -20 \cdot \log \frac{\Delta V_{\text{out}}}{\Delta V_{\text{icm}} \cdot A_v}$$

### 4.2 Supply voltage rejection ratio (SVR)

The supply-voltage rejection ratio (SVR) measures the ability of the current-sensing amplifier to reject any variation of the supply voltage  $V_{CC}$ . The SVR is referred back to the input so that its effect can be compared with the applied differential signal. The SVR is defined by the formula:

$$\text{SVR} = -20 \cdot \log \frac{\Delta V_{\text{out}}}{\Delta V_{CC} \cdot A_v}$$

### 4.3 Gain ( $A_v$ ) and input offset voltage ( $V_{os}$ )

The input offset voltage is defined as the intersection between the linear regression of the  $V_{\text{out}}$  versus  $V_{\text{sense}}$  curve with the X-axis (see [Figure 20](#)). If  $V_{\text{out1}}$  is the output voltage with  $V_{\text{sense}}=V_{\text{sense1}}=50\text{mV}$  and  $V_{\text{out2}}$  is the output voltage with  $V_{\text{sense}}=V_{\text{sense2}}=5\text{mV}$ , then  $V_{os}$  can be calculated with the following formula:

$$V_{os} = V_{\text{sense1}} - \left( \frac{V_{\text{sense1}} - V_{\text{sense2}}}{V_{\text{out1}} - V_{\text{out2}}} \cdot V_{\text{out1}} \right)$$

The amplification gain  $A_v$  is defined as the ratio between output voltage and input differential voltage:

$$A_v = \frac{V_{\text{out}}}{V_{\text{sense}}}$$

Figure 20.  $V_{out}$  versus  $V_{sense}$  characteristics: detail for low  $V_{sense}$  values

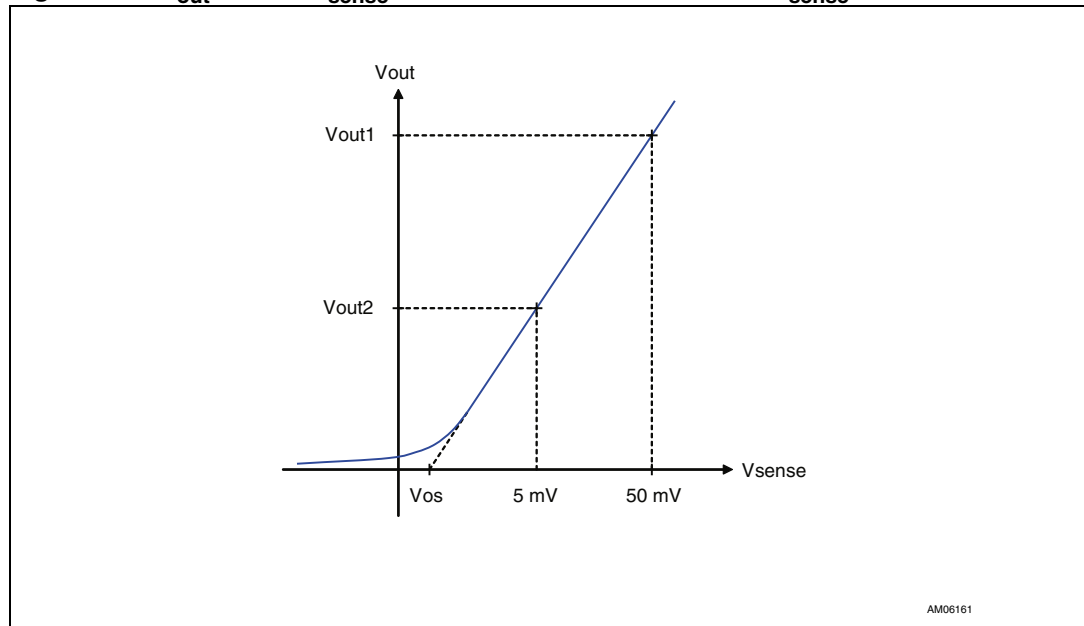

#### 4.4 Output voltage drift versus temperature

The output voltage drift versus temperature is defined as the maximum variation of  $V_{out}$  with respect to its value at  $25^\circ\text{C}$ , over the temperature range. It is calculated as follows:

$$\frac{\Delta V_{out}}{\Delta T} = \max \frac{V_{out}(T_{amb}) - V_{out}(25^\circ\text{C})}{T_{amb} - 25^\circ\text{C}}$$

with  $T_{min} < T_{amb} < T_{max}$ .

Figure 21 provides a graphical definition of output voltage drift versus temperature. On this chart,  $V_{out}$  is always comprised in the area defined by dotted lines representing the maximum and minimum variation of  $V_{out}$  versus  $T$ .

Figure 21. Output voltage drift versus temperature

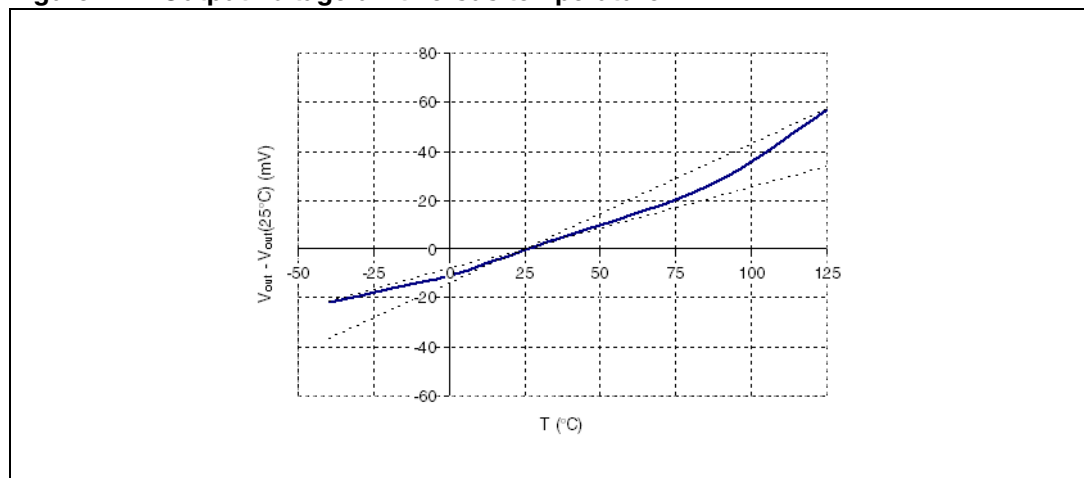

## 4.5 Output voltage accuracy

The output voltage accuracy is the difference between the actual output voltage and the theoretical output voltage. Ideally, the current sensing output voltage should be equal to the input differential voltage multiplied by the theoretical gain, as in the following formula:

$$V_{\text{out-th}} = A_v \cdot V_{\text{sense}}$$

The actual value is very slightly different, mainly due to the effects of:

- the input offset voltage  $V_{\text{OS}}$ ,
- non-linearity

**Figure 22.  $V_{\text{out}}$  vs.  $V_{\text{sense}}$  theoretical and actual characteristics**

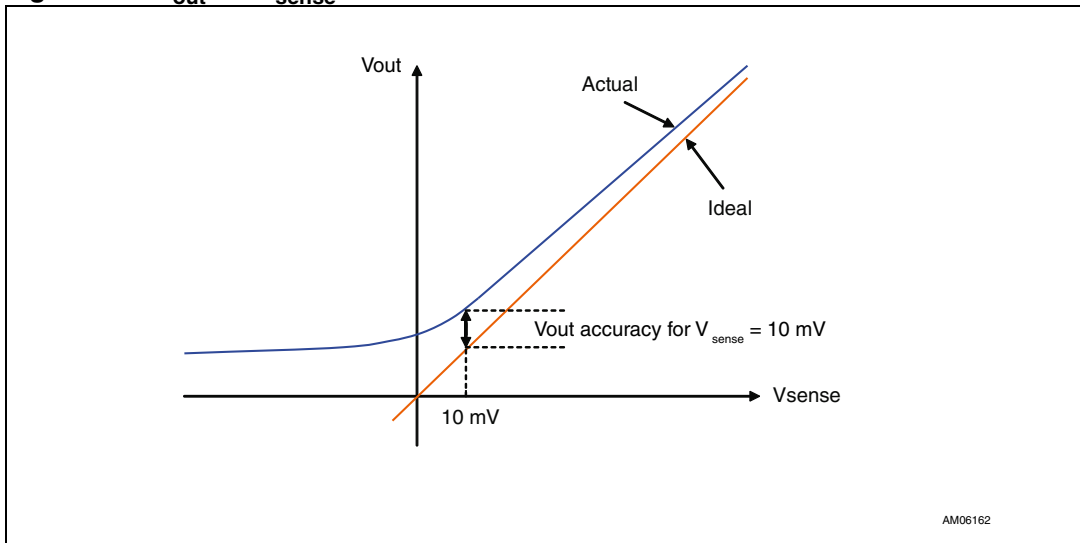

The output voltage accuracy, expressed in percentage, can be calculated with the following formula:

$$\Delta V_{\text{out}} = \frac{\text{abs}(V_{\text{out}} - (A_v \cdot V_{\text{sense}}))}{A_v \cdot V_{\text{sense}}}$$

with  $A_v = 20 \text{ V/V}$  for TSC101A,  $A_v = 50 \text{ V/V}$  for TSC101B and  $A_v = 100 \text{ V/V}$  for TSC101C.

## 5 Application information

The TSC101 can be used to measure current and to feed back the information to a microcontroller, as shown in [Figure 23](#).

**Figure 23. Typical application schematic**

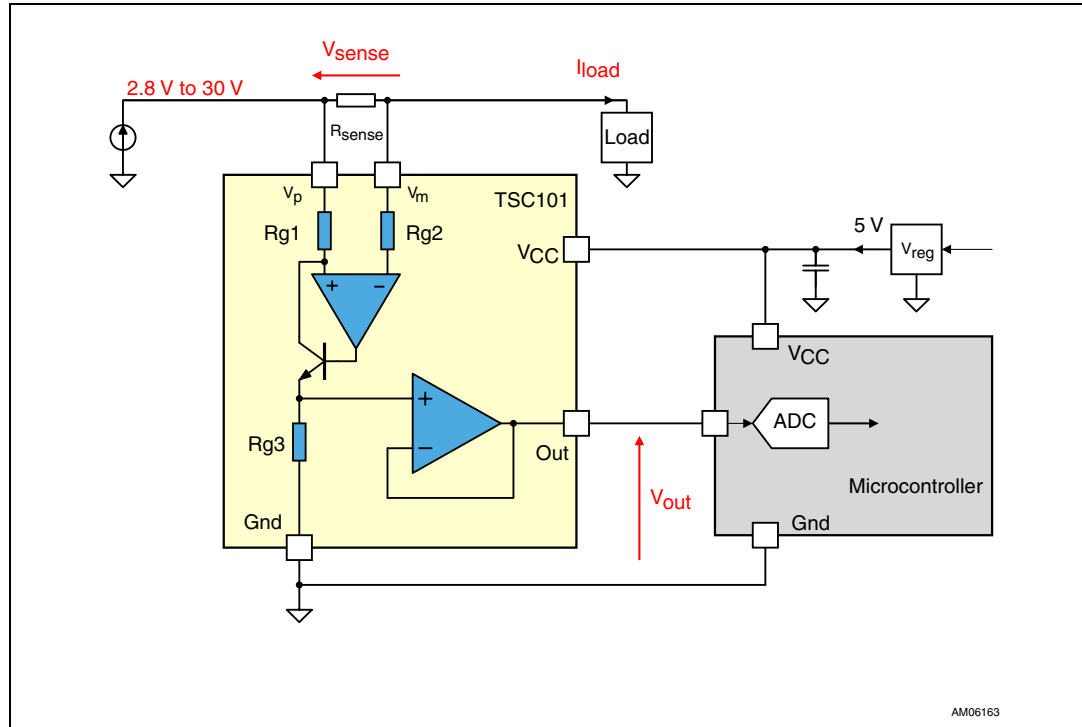

The current from the supply flows to the load through the  $R_{sense}$  resistor causing a voltage drop equal to  $V_{sense}$  across  $R_{sense}$ . The amplifier input currents are negligible, therefore its inverting input voltage is equal to  $V_m$ . The amplifier's open-loop gain forces its non-inverting input to the same voltage as the inverting input. As a consequence, the amplifier adjusts current flowing through  $R_{g1}$  so that the voltage drop across  $R_{g1}$  exactly matches  $V_{sense}$ .

Therefore, the drop across  $R_{g1}$  is:  $V_{R_{g1}} = V_{sense} = R_{sense} \cdot I_{load}$

If  $I_{R_{g1}}$  is the current flowing through  $R_{g1}$ , then  $I_{R_{g1}}$  is given by the formula:  $I_{R_{g1}} = V_{sense} / R_{g1}$

The  $I_{R_{g1}}$  current flows entirely into resistor  $R_{g3}$  (the input bias current of the buffer is negligible). Therefore, the voltage drop on the  $R_{g3}$  resistor can be calculated as follows:

$$V_{R_{g3}} = R_{g3} \cdot I_{R_{g1}} = (R_{g3} / R_{g1}) \cdot V_{sense}$$

Because the voltage across the  $R_{g3}$  resistor is buffered to the Out pin,  $V_{out}$  can be expressed as:

$$V_{out} = (R_{g3} / R_{g1}) \cdot V_{sense} \text{ or } V_{out} = (R_{g3} / R_{g1}) \cdot R_{sense} \cdot I_{load}$$

The resistor ratio  $R_{g3} / R_{g1}$  is internally set to 20V/V for TSC101A, to 50V/V for TSC101B and to 100V/V for TSC101C.

The  $R_{sense}$  resistor and the  $R_{g3} / R_{g1}$  resistor ratio (equal to  $A_v$ ) are important parameters because they define the full scale output range of your application. Therefore, they must be selected carefully.

## 6 Package information

In order to meet environmental requirements, ST offers these devices in different grades of ECOPACK® packages, depending on their level of environmental compliance. ECOPACK® specifications, grade definitions and product status are available at: [www.st.com](http://www.st.com). ECOPACK® is an ST trademark.

**Figure 24. SOT23-5L package mechanical drawing**

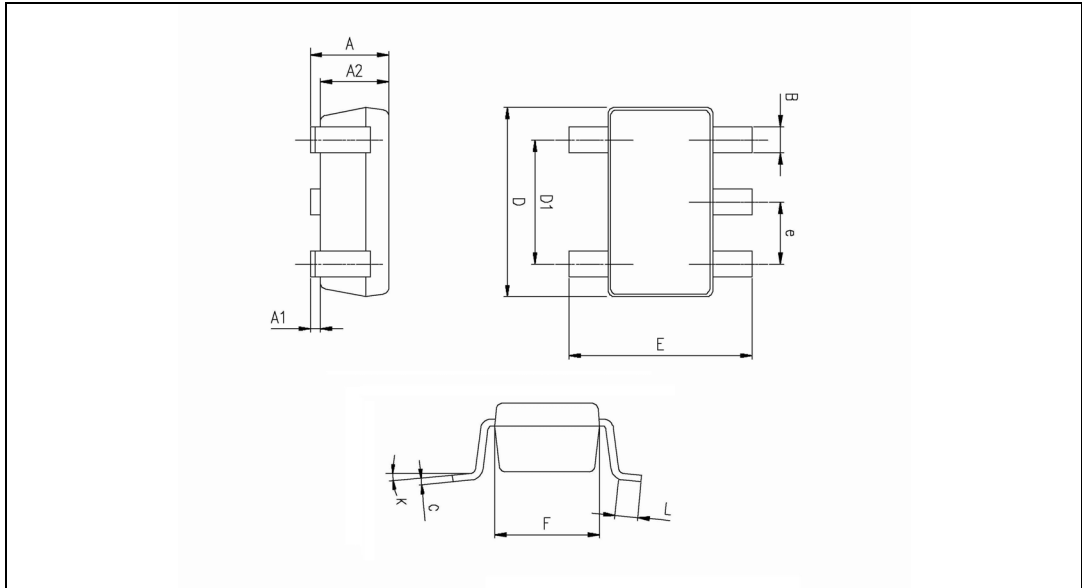

**Table 9. SOT23-5L package mechanical data**

Ref.	Dimensions					
	Millimeters			Inches		
	Min.	Typ.	Max.	Min.	Typ.	Max.
A	0.90	1.20	1.45	0.035	0.047	0.057
A1			0.15			0.006
A2	0.90	1.05	1.30	0.035	0.041	0.051
B	0.35	0.40	0.50	0.013	0.015	0.019
C	0.09	0.15	0.20	0.003	0.006	0.008
D	2.80	2.90	3.00	0.110	0.114	0.118
D1		1.90			0.075	
e		0.95			0.037	
E	2.60	2.80	3.00	0.102	0.110	0.118
F	1.50	1.60	1.75	0.059	0.063	0.069
L	0.10	0.35	0.60	0.004	0.013	0.023
K	0 degrees		10 degrees			

## 7 Ordering information

**Table 10. Order codes**

Part number	Temperature range	Package	Packaging	Marking	Gain
TSC101AILT	-40°C, +125°C	SOT23-5	Tape & reel	O104	20
TSC101BILT				O105	50
TSC101CILT				O106	100
TSC101AIYLT <sup>(1)</sup>	-40°C, +125°C	SOT23-5 (Automotive grade)	Tape & reel	O101	20
TSC101BIYLT <sup>(1)</sup>				O102	50
TSC101CIYLT <sup>(1)</sup>				O103	100

1. Qualified and characterized according to AEC Q100 and Q003 or equivalent, advanced screening according to AEC Q001 & Q 002 or equivalent.



## 8 Revision history

**Table 11. Document revision history**

Date	Revision	Changes
05-Mar-2007	1	First release, preliminary data.
22-Oct-2007	2	Document status promoted from preliminary data to datasheet. Added test results in electrical characteristics tables. Added electrical characteristics curves.
14-Mar-2011	3	Added ESD charged device model values in <a href="#">Table 2: Absolute maximum ratings</a> . Added automotive grade qualification in <a href="#">Table 10: Order codes</a> .

**Please Read Carefully:**

Information in this document is provided solely in connection with ST products. STMicroelectronics NV and its subsidiaries ("ST") reserve the right to make changes, corrections, modifications or improvements, to this document, and the products and services described herein at any time, without notice.

All ST products are sold pursuant to ST's terms and conditions of sale.

Purchasers are solely responsible for the choice, selection and use of the ST products and services described herein, and ST assumes no liability whatsoever relating to the choice, selection or use of the ST products and services described herein.

No license, express or implied, by estoppel or otherwise, to any intellectual property rights is granted under this document. If any part of this document refers to any third party products or services it shall not be deemed a license grant by ST for the use of such third party products or services, or any intellectual property contained therein or considered as a warranty covering the use in any manner whatsoever of such third party products or services or any intellectual property contained therein.

**UNLESS OTHERWISE SET FORTH IN ST'S TERMS AND CONDITIONS OF SALE ST DISCLAIMS ANY EXPRESS OR IMPLIED WARRANTY WITH RESPECT TO THE USE AND/OR SALE OF ST PRODUCTS INCLUDING WITHOUT LIMITATION IMPLIED WARRANTIES OF MERCHANTABILITY, FITNESS FOR A PARTICULAR PURPOSE (AND THEIR EQUIVALENTS UNDER THE LAWS OF ANY JURISDICTION), OR INFRINGEMENT OF ANY PATENT, COPYRIGHT OR OTHER INTELLECTUAL PROPERTY RIGHT.**

**UNLESS EXPRESSLY APPROVED IN WRITING BY AN AUTHORIZED ST REPRESENTATIVE, ST PRODUCTS ARE NOT RECOMMENDED, AUTHORIZED OR WARRANTED FOR USE IN MILITARY, AIR CRAFT, SPACE, LIFE SAVING, OR LIFE SUSTAINING APPLICATIONS, NOR IN PRODUCTS OR SYSTEMS WHERE FAILURE OR MALFUNCTION MAY RESULT IN PERSONAL INJURY, DEATH, OR SEVERE PROPERTY OR ENVIRONMENTAL DAMAGE. ST PRODUCTS WHICH ARE NOT SPECIFIED AS "AUTOMOTIVE GRADE" MAY ONLY BE USED IN AUTOMOTIVE APPLICATIONS AT USER'S OWN RISK.**

Resale of ST products with provisions different from the statements and/or technical features set forth in this document shall immediately void any warranty granted by ST for the ST product or service described herein and shall not create or extend in any manner whatsoever, any liability of ST.

ST and the ST logo are trademarks or registered trademarks of ST in various countries.

Information in this document supersedes and replaces all information previously supplied.

The ST logo is a registered trademark of STMicroelectronics. All other names are the property of their respective owners.

© 2011 STMicroelectronics - All rights reserved

STMicroelectronics group of companies

Australia - Belgium - Brazil - Canada - China - Czech Republic - Finland - France - Germany - Hong Kong - India - Israel - Italy - Japan - Malaysia - Malta - Morocco - Philippines - Singapore - Spain - Sweden - Switzerland - United Kingdom - United States of America

[www.st.com](http://www.st.com)

Компания «Океан Электроники» предлагает заключение долгосрочных отношений при поставках импортных электронных компонентов на взаимовыгодных условиях!

Наши преимущества:

- Поставка оригинальных импортных электронных компонентов напрямую с производств Америки, Европы и Азии, а так же с крупнейших складов мира;
- Широкая линейка поставок активных и пассивных импортных электронных компонентов (более 30 млн. наименований);
- Поставка сложных, дефицитных, либо снятых с производства позиций;
- Оперативные сроки поставки под заказ (от 5 рабочих дней);
- Экспресс доставка в любую точку России;
- Помощь Конструкторского Отдела и консультации квалифицированных инженеров;
- Техническая поддержка проекта, помощь в подборе аналогов, поставка прототипов;
- Поставка электронных компонентов под контролем ВП;
- Система менеджмента качества сертифицирована по Международному стандарту ISO 9001;
- При необходимости вся продукция военного и аэрокосмического назначения проходит испытания и сертификацию в лаборатории (по согласованию с заказчиком);
- Поставка специализированных компонентов военного и аэрокосмического уровня качества (Xilinx, Altera, Analog Devices, Intersil, Interpoint, Microsemi, Actel, Aeroflex, Peregrine, VPT, Syfer, Eurofarad, Texas Instruments, MS Kennedy, Miteq, Cobham, E2V, MA-COM, Hittite, Mini-Circuits, General Dynamics и др.);

Компания «Океан Электроники» является официальным дистрибьютором и эксклюзивным представителем в России одного из крупнейших производителей разъемов военного и аэрокосмического назначения «JONHON», а так же официальным дистрибьютором и эксклюзивным представителем в России производителя высокотехнологичных и надежных решений для передачи СВЧ сигналов «FORSTAR».



## JONHON

«JONHON» (основан в 1970 г.)

Разъемы специального, военного и аэрокосмического назначения:

(Применяются в военной, авиационной, аэрокосмической, морской, железнодорожной, горно- и нефтедобывающей отраслях промышленности)

«FORSTAR» (основан в 1998 г.)

ВЧ соединители, коаксиальные кабели,  
кабельные сборки и микроволновые компоненты:

(Применяются в телекоммуникациях гражданского и специального назначения, в средствах связи, РЛС, а так же военной, авиационной и аэрокосмической отраслях промышленности).



Телефон: 8 (812) 309-75-97 (многоканальный)

Факс: 8 (812) 320-03-32

Электронная почта: [ocean@oceanchips.ru](mailto:ocean@oceanchips.ru)

Web: <http://oceanchips.ru/>

Адрес: 198099, г. Санкт-Петербург, ул. Калинина, д. 2, корп. 4, лит. А