

---

### 600 mA 6 MHz Synchronous Step-down DC/DC Converter

---

NO. EA-318-151124

#### OUTLINE

The RP508x is a low supply current CMOS-based PWM/VFM step-down DC/DC converter with synchronous rectifier featuring 600 mA<sup>\*1</sup> output current. Internally, a single converter consists of an oscillator, a reference voltage unit, an error amplifier, a switching control circuit, a mode control circuit, a soft-start circuit, an under-voltage lockout (UVLO) circuit, an over current protection circuit, a thermal shutdown circuit and switching transistors.

By the adoption of the synchronous rectification circuit with built-in switching transistors, the RP508x works as super efficient step-down DC/DC converter, without connecting external diodes. Using synchronous rectification not only increases circuit performance but also allows a design to reduce parts count.

Power controlling method can be selected from forced PWM control type or PWM/VFM auto switching control type by inputting a signal to the MODE pin. In low output current, forced PWM control switches at fixed frequency rate in order to reduce noise. Likewise, in low output current, PWM/VFM auto switching control automatically switches from PWM mode to VFM mode in order to achieve high efficiency.

Output voltage is internally fixed type which allows output voltages that range from 0.8 V to 3.3 V in 0.1 V step. The output voltage accuracy is as high as  $\pm 1.5\%$  or  $\pm 18$  mV.

Protection circuits included in the RP508x are over current protection circuit and thermal shutdown circuit. Over current protection circuit supervises the inductor peak current in each switching cycle, and if the current exceeds the  $I_{LX}$  current limit ( $I_{LXLIM}$ ), it turns off P-channel Tr. Thermal shutdown circuit detects overheating of the converter if the output pin is shorted to the ground pin (GND) etc. and stops the converter operation to protect it from damage if the junction temperature exceeds the specified temperature.

The RP508x is offered in a small and thin 6-pin DFN(PLP)1212-6F package which achieves the smallest possible footprint solution on boards where area is limited.

For an input capacitor ( $C_{IN}$ ) and an output capacitor ( $C_{OUT}$ ), the smaller sized 0402/1005 (inch/mm) capacitor can be used. For an inductor (L), the smaller sized 0603/1608 or 1005/2012 (inch/mm) inductor can be used.

<sup>\*1</sup> This is an approximate value. The output current is dependent on conditions and external components.

## FEATURES

- Input Voltage Range ( $V_{IN}$ ) ..... 2.3 V to 5.5 V (Absolute Maximum Ratings: 6.5 V)
- Output Voltage Range ( $V_{OUT}$ ) ..... 0.8 V to 3.3 V (Adjustable in 0.1 V steps)
- Supply Current ( $I_{DD2}$ ) ..... Typ. 15  $\mu$ A (VFM Mode with No-load)
- Standby Current ( $I_{standby}$ ) ..... Typ. 0  $\mu$ A
- Output Voltage Temperature Coefficient ( $\Delta V_{OUT}/T_a$ ) ..... Typ.  $\pm 100$  ppm/ $^{\circ}$ C
- Oscillator Frequency ( $f_{osc}$ ) ..... Typ. 6.0 MHz
- Maximum Duty Cycle (Maxduty) ..... 100%
- Built-in Driver ON Resistance ( $R_{ONP}$ ,  $R_{ONN}$ ) ..... Typ. Pch. 0.33  $\Omega$ , Nch. 0.24  $\Omega$  ( $V_{IN} = 3.6$  V)
- UVLO Detector Threshold ( $V_{UVLO01}$ ) ..... Typ. 2.0 V
- Soft-start Time ( $t_{start}$ ) ..... Typ. 90  $\mu$ s
- $L_x$  Current Limit Circuit ( $I_{LXLIM}$ ) ..... Typ. 1.1 A
- Output Voltage Accuracy .....  $\pm 1.5\%$  ( $V_{OUT} \geq 1.2$  V) or  $\pm 18$  mV ( $V_{OUT} < 1.2$  V)
- Package ..... DFN(PLP)1212-6F

## APPLICATIONS

- Cellular Phones
- Smartphones
- Digital Still Camera
- Notebook PCs, PDA's
- Li-ion Battery-used Equipment

# BLOCK DIAGRAM

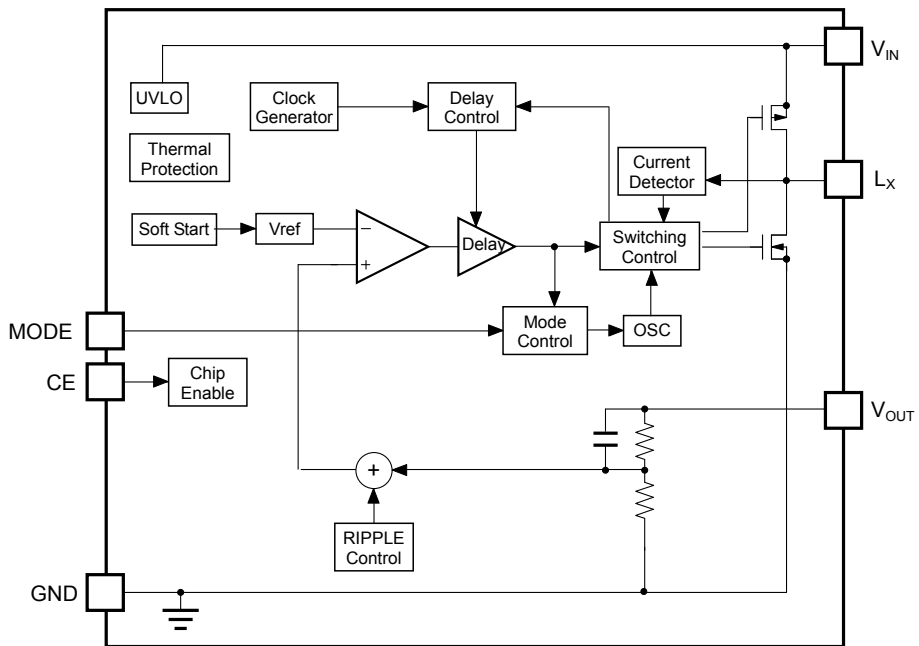

RP508xxx1A Block Diagram

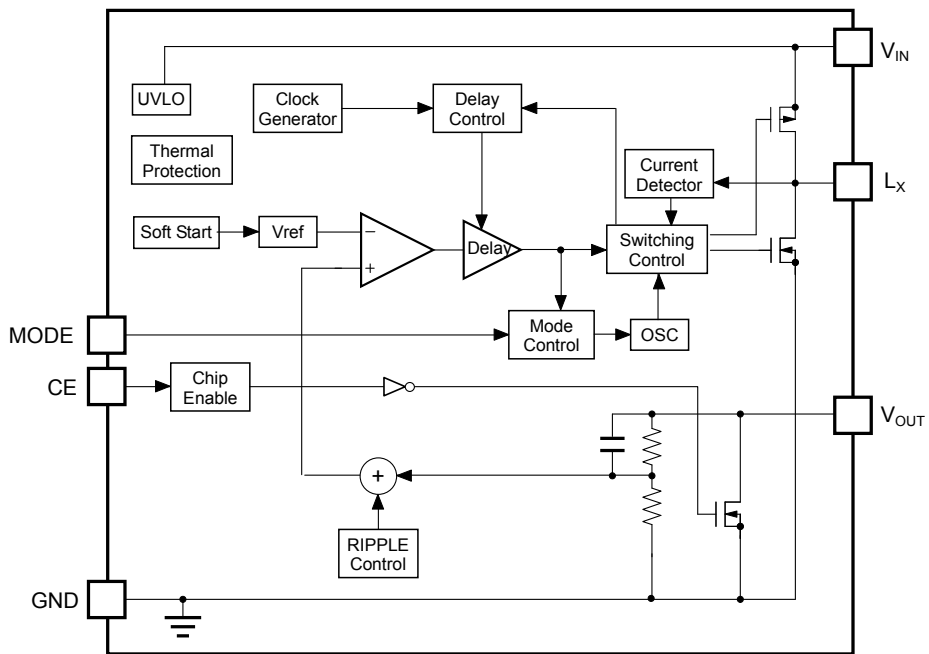

RP508xxx1B Block Diagram

## SELECTION GUIDE

The set output voltage and the auto discharge<sup>\*1</sup> function are user-selectable options.

### Selection Guide

Product Name	Package	Quantity per Reel	Pb Free	Halogen Free
RP508Kxx1\$-TR	DFN(PLP)1212-6F	5,000 pcs	Yes	Yes

xx: Specify the set output voltage ( $V_{SET}$ ) within the range of 0.8 V (08) to 3.3 V (33) in 0.1 V<sup>\*2</sup> steps.

If the set output voltage includes the 3rd digit, indicate the digit of 0.01.  
(1.05 V, 1.25 V, 1.35 V)

Ex. If the set output voltage is 1.05 V: RP508K101\$5  
If the set output voltage is 1.25 V: RP508K121\$5  
If the set output voltage is 1.35 V: RP508K131\$5

\$: Specify the auto-discharge option.

A: Fixed output voltage type  
B: Fixed output voltage type, auto-discharge function in shutdown mode

<sup>\*1</sup> Auto-discharge function quickly lowers the output voltage to 0 V, when the chip enable signal is switched from the active mode to the standby mode, by releasing the electrical charge accumulated in the external capacitor.

<sup>\*2</sup> 0.05 V step is also available as a custom code.

## PIN DESCRIPTION

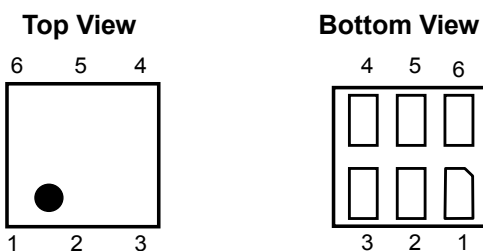

DFN(PLP)1212-6F Pin Configurations

### Pin Description

Pin No.	Symbol	Pin Description
1	$V_{OUT}$	Output Pin
2	MODE	Mode Control Pin ("H" forced PWM control, "L" PWM/VFM auto switching control)
3	CE	Chip Enable Pin ("H" active)
4	$V_{IN}$	Input Pin
5	$L_X$	$L_X$ Switching Pin
6	GND	Ground Pin

## ABSOLUTE MAXIMUM RATINGS

### Absolute Maximum Ratings

Symbol	Item	Rating	Unit
$V_{IN}$	$V_{IN}$ Input Voltage	-0.3 to 6.5	V
$V_{LX}$	$L_X$ Pin Voltage	-0.3 to $V_{IN} + 0.3$	V
$V_{CE}$	CE Pin Input Voltage	-0.3 to 6.5	V
$V_{MODE}$	MODE Pin Input Voltage	-0.3 to 6.5	V
$V_{OUT}$	$V_{OUT}$ Pin Voltage	-0.3 to 6.5	V
$I_{LX}$	$L_X$ Pin Output Current	1300	mA
$P_D$	Power Dissipation (JEDEC STD 51-7 Test Land Pattern ) <sup>*1</sup>	666	mW
$T_a$	Operating Temperature Range	-40 to 85	°C
$T_{stg}$	Storage Temperature Range	-55 to 125	°C

<sup>\*1</sup> Refer to the section of *PACKAGE INFORMATION* for detailed information.

### ABSOLUTE MAXIMUM RATINGS

Electronic and mechanical stress momentarily exceeded absolute maximum ratings may cause the permanent damages and may degrade the life time and safety for both device and system using the device in the field. The functional operation at or over these absolute maximum ratings are not assured.

### RECOMMENDED OPERATING CONDITIONS (ELECTRICAL CHARACTERISTICS)

All of electronic equipment should be designed that the mounted semiconductor devices operate within the recommended operating conditions. The semiconductor devices cannot operate normally over the recommended operating conditions, even if when they are used over such conditions by momentary electronic noise or surge. And the semiconductor devices may receive serious damage when they continue to operate over the recommended operating conditions.

## ELECTRICAL CHARACTERISTICS

### Electrical Characteristics

(Ta = 25°C)

Symbol	Item	Conditions	Min.	Typ.	Max.	Unit	
V <sub>IN</sub>	Operating Input Voltage		2.3		5.5	V	
V <sub>OUT</sub>	Output Voltage	V <sub>IN</sub> = V <sub>CE</sub> = 3.6 V	V <sub>SET</sub> ≥ 1.2 V	x0.985	x1.015	V	
			V <sub>SET</sub> < 1.2 V	-0.018	+0.018	V	
ΔV <sub>OUT</sub> / ΔTa	Output Voltage Temperature Coefficient	-40°C ≤ Ta ≤ 85°C		±100		ppm / °C	
fosc	Oscillator Frequency	*1	5.4	6.0	6.6	MHz	
I <sub>DD1</sub>	Supply Current 1	V <sub>IN</sub> = V <sub>CE</sub> = 5.5 V, V <sub>OUT</sub> = V <sub>SET</sub> × 0.8		1000	1300	μA	
I <sub>DD2</sub>	Supply Current 2	V <sub>IN</sub> = V <sub>CE</sub> = V <sub>OUT</sub> = 5.5 V	V <sub>MODE</sub> = 0 V		15	25	μA
			V <sub>MODE</sub> = 5.5 V		1000	1300	μA
I <sub>standby</sub>	Standby Current	V <sub>IN</sub> = 5.5 V, V <sub>CE</sub> = 0 V		0	5	μA	
I <sub>CEH</sub>	CE "H" Input Current	V <sub>IN</sub> = V <sub>CE</sub> = 5.5 V	-1	0	1	μA	
I <sub>CEL</sub>	CE "L" Input Current	V <sub>IN</sub> = 5.5 V, V <sub>CE</sub> = 0 V	-1	0	1	μA	
I <sub>MODEH</sub>	Mode "H" Input Current	V <sub>IN</sub> = V <sub>MODE</sub> = 5.5 V, V <sub>CE</sub> = 0 V	-1	0	1	μA	
I <sub>MODEL</sub>	Mode "L" Input Current	V <sub>IN</sub> = 5.5 V, V <sub>CE</sub> = V <sub>MODE</sub> = 0 V	-1	0	1	μA	
I <sub>VOUTH</sub>	V <sub>OUT</sub> "H" Input Current*2	V <sub>IN</sub> = V <sub>OUT</sub> = 5.5 V, V <sub>CE</sub> = 0 V	-1	0	1	μA	
I <sub>VOUTL</sub>	V <sub>OUT</sub> "L" Input Current	V <sub>IN</sub> = 5.5 V, V <sub>CE</sub> = V <sub>OUT</sub> = 0 V	-1	0	1	μA	
R <sub>LOW</sub>	On Resistance for Auto Discharge*3	V <sub>IN</sub> = 3.6 V, V <sub>CE</sub> = 0 V		30		Ω	
I <sub>LXLEAKH</sub>	L <sub>X</sub> Leakage Current "H"	V <sub>IN</sub> = V <sub>LX</sub> = 5.5 V, V <sub>CE</sub> = 0 V	-1	0	5	μA	
I <sub>LXLEAKL</sub>	L <sub>X</sub> Leakage Current "L"	V <sub>IN</sub> = 5.5 V, V <sub>CE</sub> = V <sub>LX</sub> = 0 V	-5	0	1	μA	
V <sub>CEH</sub>	CE "H" Input Voltage	V <sub>IN</sub> = 5.5 V	1.0			V	
V <sub>CEL</sub>	CE "L" Input Voltage	V <sub>IN</sub> = 2.3 V			0.4	V	
V <sub>MODEH</sub>	Mode "H" Input Voltage	V <sub>IN</sub> = V <sub>CE</sub> = 5.5 V	1.0			V	
V <sub>MODEL</sub>	Mode "L" Input Voltage	V <sub>IN</sub> = V <sub>CE</sub> = 2.3 V			0.4	V	
R <sub>ONP</sub>	On Resistance of Pch Tr.	V <sub>IN</sub> = 3.6 V, I <sub>LX</sub> = -100 mA		0.33		Ω	
R <sub>ONN</sub>	On Resistance of Nch Tr.	V <sub>IN</sub> = 3.6 V, I <sub>LX</sub> = -100 mA		0.24		Ω	
Maxduty	Maximum Duty Cycle		100			%	
t <sub>start</sub>	Soft-start Time	*4		90	150	μs	
I <sub>LXLIM</sub>	L <sub>X</sub> Current Limit		900	1100		mA	
V <sub>UVLO1</sub>	UVLO Detector Threshold	V <sub>IN</sub> = V <sub>CE</sub>	1.9	2.0	2.1	V	
V <sub>UVLO2</sub>	UVLO Released Voltage	V <sub>IN</sub> = V <sub>CE</sub>	2.0	2.1	2.2	V	
T <sub>TSD</sub>	Thermal Shutdown Temperature	Junction Temperature		140		°C	
T <sub>TSR</sub>	Thermal Shutdown Released Temperature	Junction Temperature		100		°C	

All test items listed under *ELECTRICAL CHARACTERISTICS* are done under the pulse load condition (T<sub>j</sub> ≈ Ta = 25°C) except Output Voltage Temperature Coefficient.

\*1 V<sub>IN</sub> = V<sub>CE</sub> = 3.6 V (V<sub>SET</sub> ≤ 2.6 V), V<sub>IN</sub> = V<sub>CE</sub> = V<sub>SET</sub> + 1 V (V<sub>SET</sub> > 2.6 V)

\*2 RP508xxx1A only

\*3 RP508xxx1B only

\*4 Soft-start Time is between the rising edge of CE pin and V<sub>OUT</sub> ≥ V<sub>SET</sub> × 0.9.

## TYPICAL APPLICATION

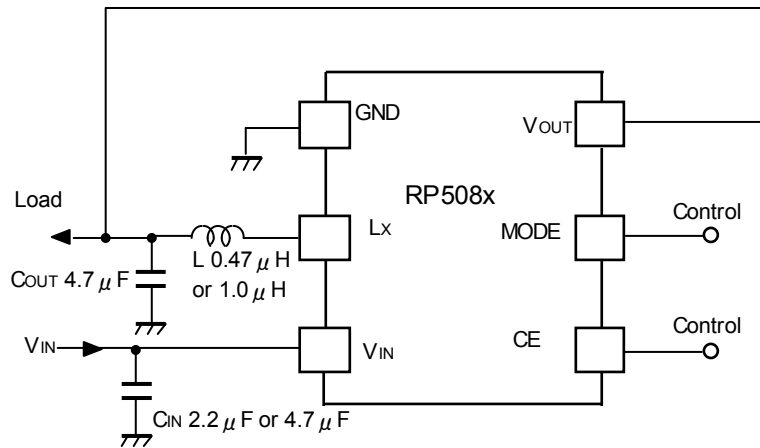

RP508x Typical Application

### Recommended Components

Symbol	Size	Type	Manufacturer
C <sub>IN</sub>	2.2 μF	Ceramic	C1005JB0J225K (TDK)
	4.7 μF	Ceramic	C1005JB0J475K (TDK)
C <sub>OUT</sub>	4.7 μF	Ceramic	C1005JB0J475K (TDK)
L	0.47 μH (0.5 μH)	Inductor	MIPSZ2012D0R5 (FDK)
			MDT1608CHR47N (TOKO)
	1.0 μH	Inductor	MIPSZ2012D1R0 (FDK)
			MDT1608CH1R0N (TOKO)

## TECHNICAL NOTES

- Ensure the  $V_{IN}$  and GND lines are sufficiently robust. A large switching current flows through the GND lines, the  $V_{DD}$  line, the  $V_{OUT}$  line, an inductor, and  $L_X$ . If their impedance is too high, noise pickup or unstable operation may result. Set the external components as close as possible to the IC and minimize the wiring between the components and the IC, especially between a capacitor ( $C_{IN}$ ) and the  $V_{IN}$  pin. The wiring between  $V_{OUT}$  and load and between L and  $V_{OUT}$  should be separated.
- Choose a low ESR ceramic capacitor. The capacitance of  $C_{IN}$  should be more than or equal to 2.2  $\mu\text{F}$ . The capacitance of a capacitor ( $C_{OUT}$ ) should be between 4.7  $\mu\text{F}$  to 10  $\mu\text{F}$ .
- The Inductance value should be set within the range of 0.47  $\mu\text{H}$  to 1.0  $\mu\text{H}$ . However, the inductance value is limited by output voltage. Refer to the table below. The phase compensation of this IC is designed according to the  $C_{OUT}$  and L values. Choose an inductor that has small DC resistance, has enough allowable current and is hard to cause magnetic saturation. If the inductance value of an inductor is extremely small, the peak current of  $L_X$  may increase. The increased  $L_X$  peak current reaches “ $L_X$  limit current” to trigger over current protection circuit even if the load current is less than 600 mA.

**Set Output Voltage Range vs. Inductance Range**

Set Output Voltage (V)	Input Voltage (V)	Inductance	
$V_{SET}$	$V_{IN}$	L = 0.47 $\mu\text{H}$	L = 1.0 $\mu\text{H}$
0.8 to 1.2	up to 5.5	Recommended	Acceptable
1.3 to 1.5	up to 4.5	Recommended	Acceptable
	4.5 to 5.5	Acceptable	Recommended
1.6 to 2.6	up to 3.6	Recommended	Acceptable
	up to 4.5	Acceptable	Recommended
	4.5 to 5.5	-	Recommended
2.7 to 3.3	up to 4.5	Recommended	Acceptable
	4.5 to 5.5	-	Recommended

- Over current protection circuit may be affected by self-heating or power dissipation environment.
- The performance of power source circuits using this IC largely depends on the peripheral circuits. When selecting the peripheral components, consider the conditions of use. Do not allow each component, PCB pattern and the IC to exceed their respected rated values (voltage, current and power) when designing the peripheral circuits.



## OPERATION OF STEP-DOWN DC/DC CONVERTER AND OUTPUT CURRENT

The step-down DC/DC converter charges energy in the inductor when  $L_x$  Tr. turns "ON", and discharges the energy from the inductor when  $L_x$  Tr. turns "OFF" and operates with less energy loss, so that a lower output voltage ( $V_{OUT}$ ) than the input voltage ( $V_{IN}$ ) can be obtained.

The operation of the step-down DC/DC converter is explained in the following figures.

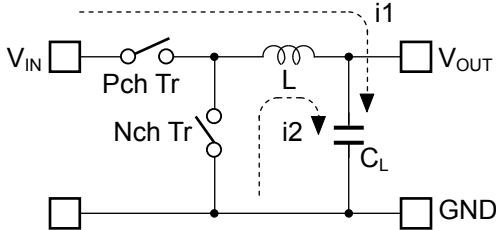

Figure 1. Basic Circuit

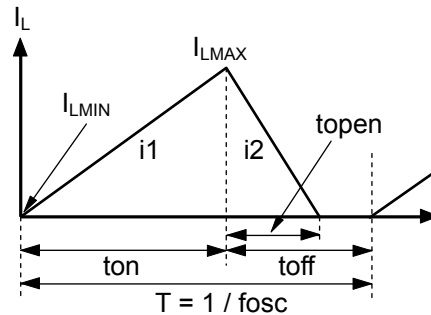

Figure 2. Inductor Current ( $I_L$ ) flowing through Inductor

**Step1.** P-channel Tr. turns "ON" and the inductor current ( $I_L = i1$ ) flows, L is charged with energy. At this moment,  $i1$  increases from the minimum inductor current ( $I_{LMIN}$ ), which is 0 A, and reaches the maximum inductor current ( $I_{LMAX}$ ) in proportion to the on-time period ( $ton$ ) of P-channel Tr.

**Step2.** When P-channel Tr. turns "OFF", L tries to maintain  $I_L$  at  $I_{LMAX}$ , so L turns N-channel Tr. "ON" and the inductor current ( $I_L = i2$ ) flows into L.

**Step3.**  $i2$  decreases gradually and reaches  $I_{LMIN}$  after the open-time period ( $topen$ ) of N-channel Tr., and then N-channel Tr. turns "OFF". This is called discontinuous current mode.

As the output current ( $I_{OUT}$ ) increases, the off-time period ( $toff$ ) of P-channel Tr. runs out before  $I_L$  reaches  $I_{LMIN}$ . The next cycle starts, and P-channel Tr. turns "ON" and N-channel Tr. turns "OFF", which means  $I_L$  starts increasing from  $I_{LMIN}$ . This is called continuous current mode.

In the case of PWM mode,  $V_{OUT}$  is maintained by controlling  $ton$ . During the PWM mode, the oscillator frequency ( $fosc$ ) is constantly maintained.

As shown in Figure 2., when the step-down DC/DC operation is constant,  $I_{LMIN}$  and  $I_{LMAX}$  during  $ton$  of P-channel Tr. is same as the P-channel Tr. during  $toff$ .

The current differential between  $I_{LMAX}$  and  $I_{LMIN}$  is described as  $\Delta I$ .

$$\Delta I = I_{LMAX} - I_{LMIN} = V_{OUT} \times topen / L = (V_{IN} - V_{OUT}) \times ton / L \dots \dots \dots \text{Equation 1}$$

However,

$$T = 1 / fosc = ton + toff$$

$$\text{Duty (\%)} = ton / T \times 100 = ton \times fosc \times 100$$

$$topen \leq toff$$

In Equation 1, " $V_{OUT} \times topen / L$ " shows the amount of current change in "OFF" state. Also, " $(V_{IN} - V_{OUT}) \times ton / L$ " shows the amount of current change at "ON" state.

**DISCONTINUOUS MODE AND CONTINUOUS MODE**

As illustrated in Figure 3., when  $I_{OUT}$  is relatively small,  $t_{open} < t_{off}$ . In this case, the energy charged into L during  $t_{on}$  will be completely discharged during  $t_{off}$ , as a result,  $I_{LMIN} = 0$ . This is called discontinuous mode.

When  $I_{OUT}$  is gradually increased, eventually  $t_{open} = t_{off}$  and when  $I_{OUT}$  is increased further, eventually  $I_{LMIN} > 0$ . This is called continuous mode.

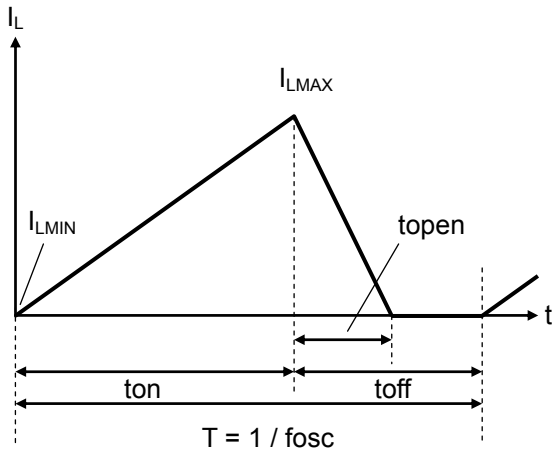

**Figure 3. Discontinuous Mode**

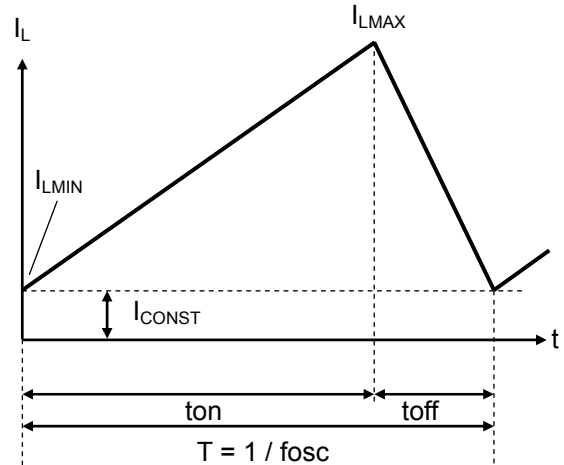

**Figure 4. Continuous Mode**

In the continuous mode, the solution of Equation 1 is described as  $t_{onc}$ .

$$t_{onc} = T \times V_{OUT} / V_{IN} \dots\dots\dots \text{Equation 2}$$

When  $t_{on} < t_{onc}$ , it indicates discontinuous mode, and when  $t_{on} \geq t_{onc}$ , it indicates continuous mode.

### FORCED PWM MODE

By setting the MODE pin to "H", the RP508x switches on/off at the fixed frequency to reduce noise even under the light load. When  $I_{OUT}$  is  $\Delta I_L / 2$  or less,  $I_{LMIN}$  becomes less than 0. That is, the accumulated electricity in  $C_L$  is discharged through the IC side at  $I_L$  increase period from  $I_{LMIN}$  to "0" during  $t_{on}$  and at  $I_L$  decrease period from "0" to  $I_{LMIN}$  during  $t_{off}$ .

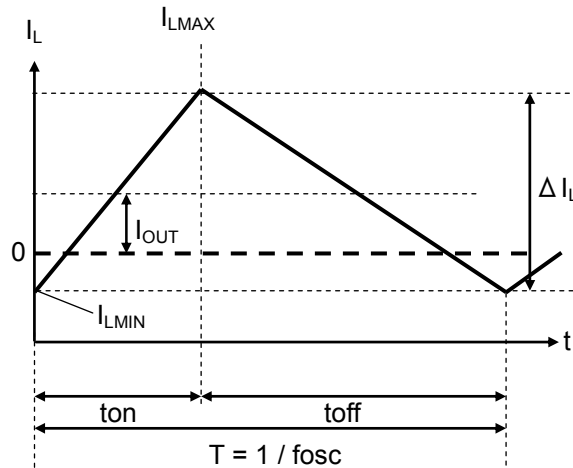

Forced PWM Mode

### VFM MODE

By setting the MODE pin to "L", in low output current, the IC automatically switches into VFM mode in order to achieve high efficiency. In VFM mode, a value of  $t_{on}$  is determined by  $V_{IN}$  and  $V_{OUT}$ .

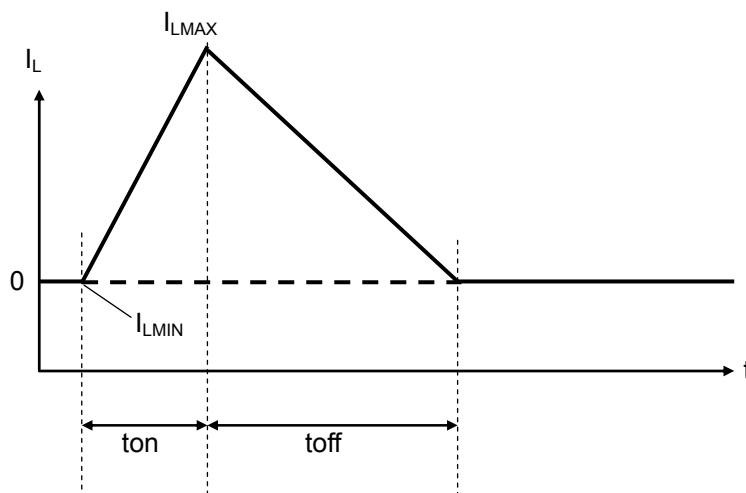

VFM Mode

## OUTPUT CURRENT AND SELECTION OF EXTERNAL COMPONENTS

The following equations explain the relationship between output current and peripheral components used in the diagrams in *TYPICAL APPLICATIONS*.

Ripple Current P-P value is described as  $I_{RP}$ , ON resistance of P-channel Tr. is described as  $R_{ONP}$ , ON resistance of N-channel Tr. is described as  $R_{ONN}$ , and DC resistor of the inductor is described as  $R_L$ .

First, when P-channel Tr. is "ON", the following equation is satisfied.

$$V_{IN} = V_{OUT} + (R_{ONP} + R_L) \times I_{OUT} + L \times I_{RP} / t_{on} \dots\dots\dots \text{Equation 3}$$

Second, when P-channel Tr. is "OFF" (N-channel Tr. is "ON"), the following equation is satisfied.

$$L \times I_{RP} / t_{off} = R_{ONN} \times I_{OUT} + V_{OUT} + R_L \times I_{OUT} \dots\dots\dots \text{Equation 4}$$

Put Equation 4 into Equation 3 to solve ON duty of P-channel Tr. ( $D_{ON} = t_{on} / (t_{off} + t_{on})$ ):

$$D_{ON} = (V_{OUT} + R_{ONN} \times I_{OUT} + R_L \times I_{OUT}) / (V_{IN} + R_{ONN} \times I_{OUT} - R_{ONP} \times I_{OUT}) \dots\dots\dots \text{Equation 5}$$

Ripple Current is described as follows:

$$I_{RP} = (V_{IN} - V_{OUT} - R_{ONP} \times I_{OUT} - R_L \times I_{OUT}) \times D_{ON} / f_{osc} / L \dots\dots\dots \text{Equation 6}$$

Peak current that flows through L, and  $L_x$  Tr. is described as follows:

$$I_{LXMAX} = I_{OUT} + I_{RP} / 2 \dots\dots\dots \text{Equation 7}$$

Consider  $I_{LXMAX}$  when setting conditions of input and output, as well as selecting the external components. The above calculation formulas are based on the ideal operation of the  $I_{CS}$  in continuous mode.

## TIMING CHART

### SOFT-START TIME

#### Starting-up with CE Pin

The IC starts to operate when the CE pin voltage ( $V_{CE}$ ) exceeds the threshold voltage. The threshold voltage is preset between CE “H” input voltage ( $V_{CEH}$ ) and CE “L” input voltage ( $V_{CEL}$ ).

After the start-up of the IC, soft-start circuit starts to operate. Then, after a certain period of time, the reference voltage ( $V_{REF}$ ) in the IC gradually increases up to the specified value.

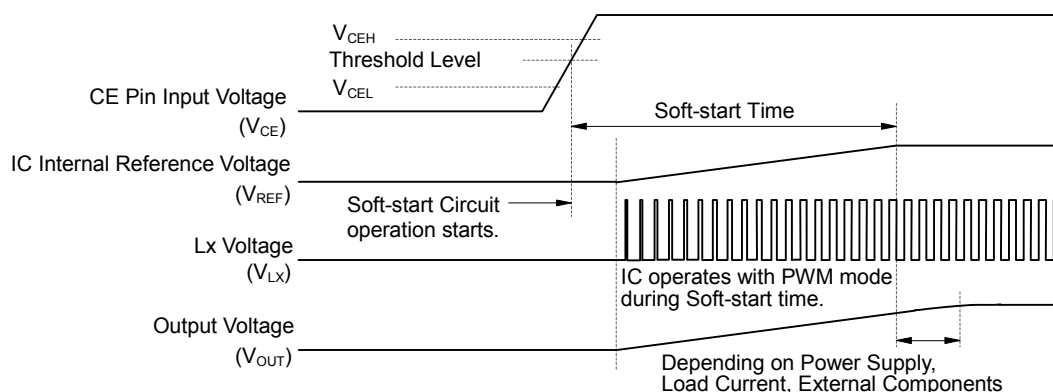

Soft-start time starts when soft-start circuit is activated, and ends when the reference voltage reaches the specified voltage.

Soft start time is not always equal to the turn-on speed of the step-down DC/DC converter. Note that the turn-on speed could be affected by the power supply capacity, the output current, the inductance value and the  $C_{OUT}$  value.

#### Starting-up with Power Supply

After the power-on, when  $V_{IN}$  exceeds the UVLO released voltage ( $V_{UVLO2}$ ), the IC starts to operate. Then, soft-start circuit starts to operate and after a certain period of time,  $V_{REF}$  gradually increases up to the specified value. Soft-start time starts when soft-start circuit is activated, and ends when  $V_{REF}$  reaches the specified voltage.

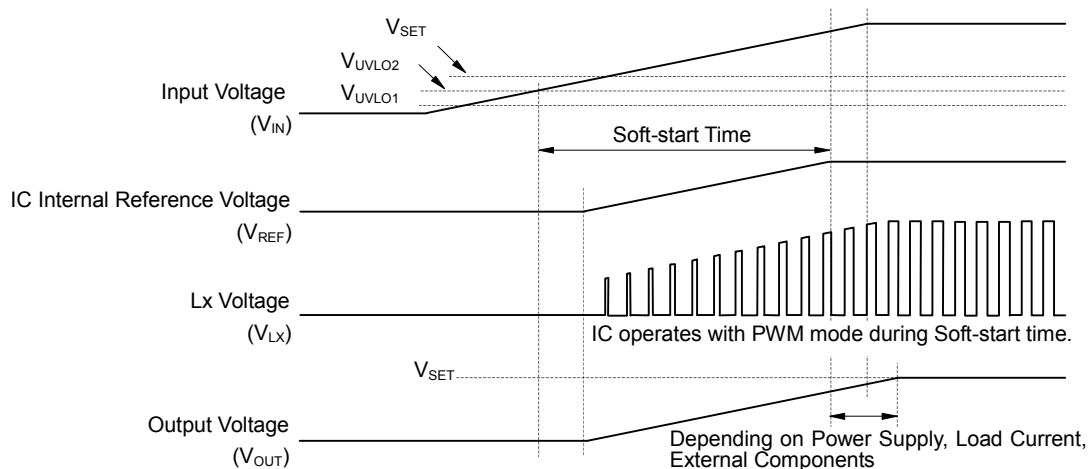

Note that the turn-on speed of  $V_{OUT}$  could be affected by the power supply capacity, the output current, the inductance value, the  $C_{OUT}$  value and the turn-on speed of  $V_{IN}$  determined by  $C_{IN}$ .

**Under Voltage Lockout (UVLO) Circuit**

If  $V_{IN}$  becomes lower than  $V_{SET}$ , the step-down DC/DC converter stops the switching operation and ON duty becomes 100%, and then  $V_{OUT}$  gradually drops according to  $V_{IN}$ .

If the  $V_{IN}$  becomes lower than the UVLO detector threshold ( $V_{UVLO1}$ ), the UVLO circuit starts to operate,  $V_{REF}$  stops, and P-channel and N-channel built-in switch transistors turn "OFF". As a result,  $V_{OUT}$  drops according to the  $C_{OUT}$  capacitance value and the load.

To restart the operation,  $V_{IN}$  needs to be higher than  $V_{UVLO2}$ . The timing chart below shows the voltage shifts of  $V_{REF}$ ,  $V_{LX}$  and  $V_{OUT}$  when  $V_{IN}$  value is varied.

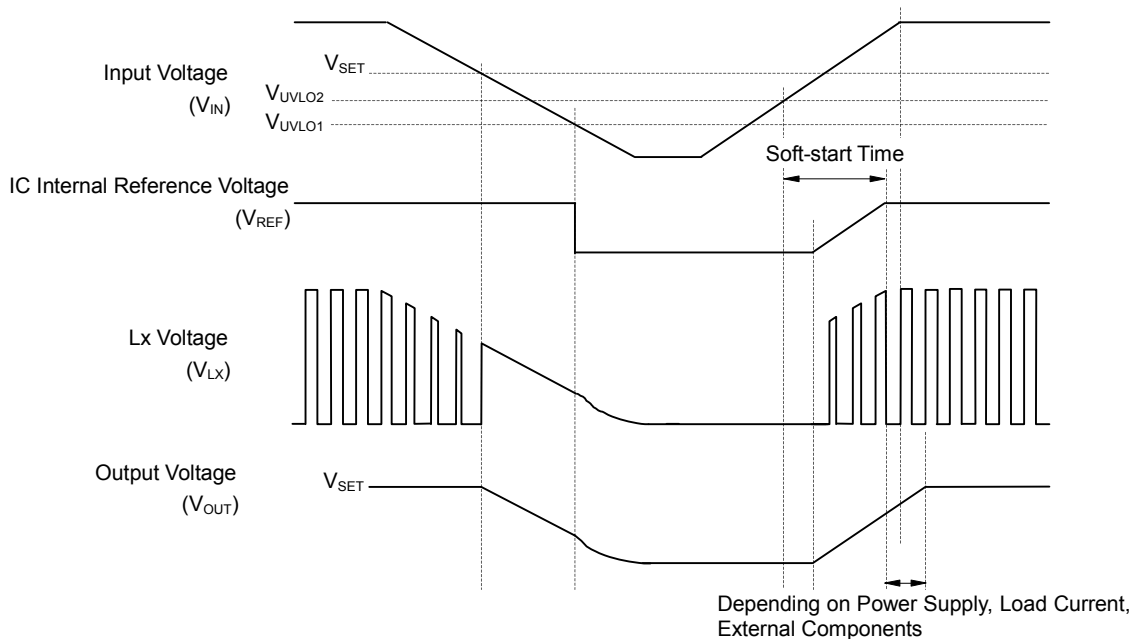

Falling edge (operating) and rising edge (releasing) waveforms of  $V_{OUT}$  could be affected by the initial voltage of  $C_{OUT}$  and the output current of  $V_{OUT}$ .

**Over Current Protection Circuit**

Over current protection circuit supervises the inductor peak current (the peak current flowing through P-channel Tr.) in each switching cycle. If the current exceeds the  $L_x$  current limit ( $I_{LxLIM}$ ) of 1100 mA (Typ.), P-channel Tr. is turned off.

$I_{LxLIM}$  could be easily affected by self-heating or ambient environment. If the  $V_{IN}$  drops dramatically or becomes unstable due to short-circuit, protection operation could be affected.

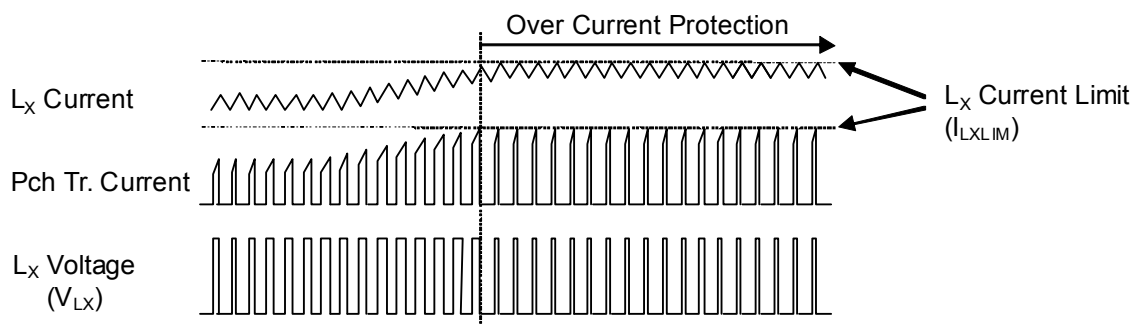

## RP508x FEATURES

### FAST FREQUENCY AND FAST RESPONSE

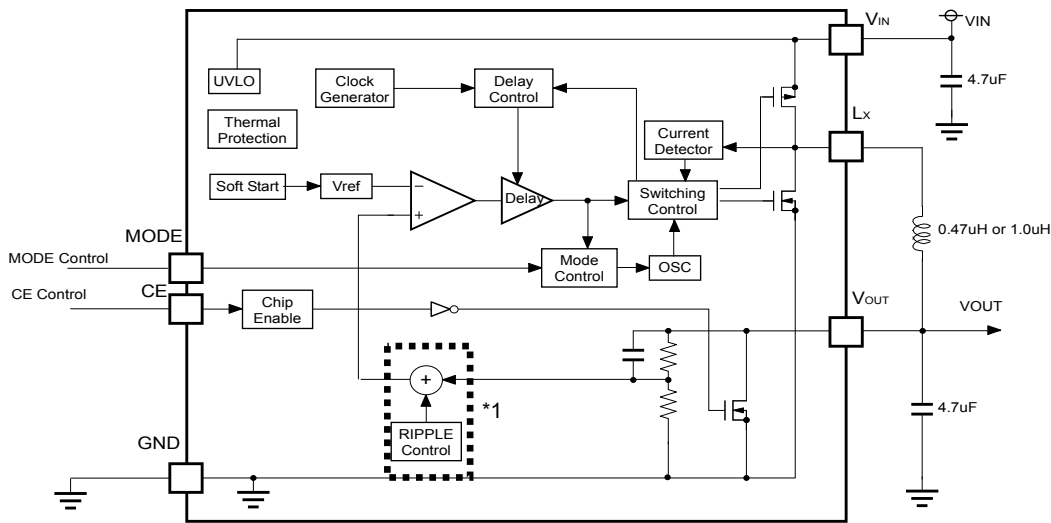

There are the following advantages when it operates at fast frequency (6 MHz).

- Inductance value can be reduced.
- The fluctuation of energy in one cycle is fast and small, as a result, the capacitance value of  $C_{OUT}$  can be also reduced.
- Small LC value reduced the feedback delay, then response frequency band can be wide and transient response is much improved compared with conventional line-up.

\*1 Ripple is added and easy to detect and stabilize the system.

### MAXIMUM FREQUENCY (6 MHz) LOCK

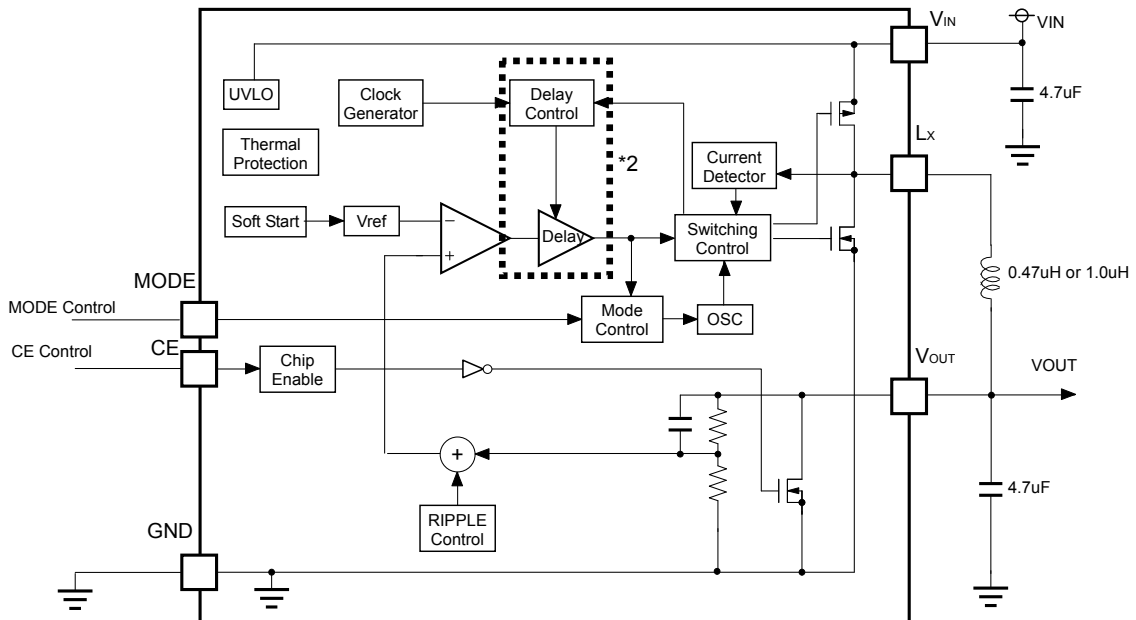

Switching frequency in order to become reference frequency (6 MHz), delay time is included the output voltage feedback loop and locked the frequency (6 MHz).

\*2 The frequency goes faster and faster without this.



### FREQUENCY CONTROL FOR MINIMUM ON/OFF TIME

Minimum on/off time/Minimum off time is set. (But 100% duty is available.) In the 6 MHz, based on the calculation of input/ output relation, on/off time can be calculated, and if it is not satisfy the minimum on time / minimum off time, the reference frequency must be reduced and switching frequency is reduced.

**(Ex.) Min On Time (40 ns)**

- ①  $V_{IN} = 3.6\text{ V}$   $V_{OUT} = 1.0\text{ V}$   
 $1/6\text{ MHz} \times 1.0\text{ V} / 3.6\text{ V} \approx 46\text{ ns} > \text{Min On Time} (= 40\text{ ns})$   
 →6 MHz Switching OK
- ②  $V_{IN} = 5.5\text{ V}$   $V_{OUT} = 1.0\text{ V}$   
 $1/6\text{ MHz} \times 1.0\text{ V} / 5.5\text{ V} \approx 30\text{ ns} < \text{Min On Time} (= 40\text{ ns})$   
 →It must be slow down from 6 MHz

LX Waveform

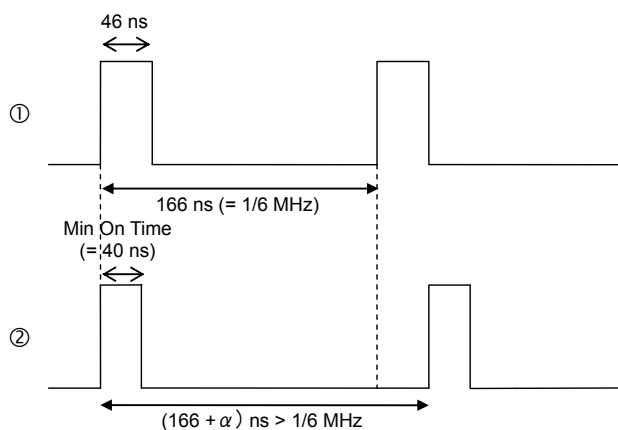

Cycle time becomes long in order to satisfy Min. on time. It is suitable with keeping the duty.

**(Ex.) Min Off Time (40 ns)**

- ①  $V_{IN} = 5.0\text{ V}$   $V_{OUT} = 3.3\text{ V}$   
 $1/6\text{ MHz} \times (1 - 3.3\text{ V} / 5.0\text{ V}) \approx 57\text{ ns} > \text{Min Off Time} (= 40\text{ ns})$   
 →6 MHz Switching OK
- ②  $V_{IN} = 4.2\text{ V}$   $V_{OUT} = 3.3\text{ V}$   
 $1/6\text{ MHz} \times (1 - 3.3\text{ V} / 4.2\text{ V}) \approx 36\text{ ns} < \text{Min Off Time} (= 40\text{ ns})$   
 →It must be slow down from 6 MHz

LX Waveform

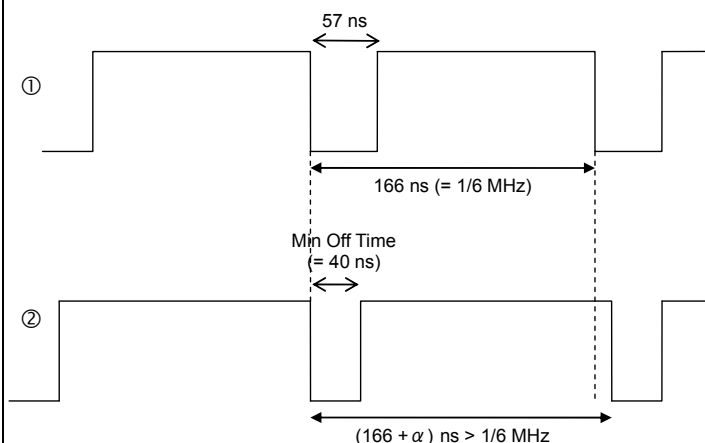

Cycle time becomes long in order to satisfy Min. off time. It is suitable with keeping the duty.

## PACKAGE INFORMATION

### POWER DISSIPATION (DFN(PLP)1212-6F)

Power Dissipation ( $P_D$ ) of the package is dependent on PCB material, layout, and environmental conditions. The following conditions are used in this measurement.

#### Measurement Conditions

JEDEC STD 51-7 Test Land Pattern	
Environment	Mounting on Board (Wind Velocity = 0 m/s)
Board Material	Glass Cloth Epoxy Plastic (4 Layers)
Board Dimensions	76.2 mm × 114.3 mm × 1.6 mm
Copper Ratio	Top side, Back side: 60 mm square, Approx. 10% 2nd, 3rd: Approx. 100%
Through-holes	φ 0.85 mm x 44 pcs

#### Measurement Result

( $T_a = 25^\circ\text{C}$ ,  $T_{j\text{max}} = 125^\circ\text{C}$ )

JEDEC STD 51-7 Test Land Pattern	
Power Dissipation	666 mW
Thermal Resistance	$\Theta_{ja} = (125 - 25^\circ\text{C}) / 0.666 \text{ W} = 150^\circ\text{C/W}$
	$\Theta_{jc} = 28^\circ\text{C/W}$

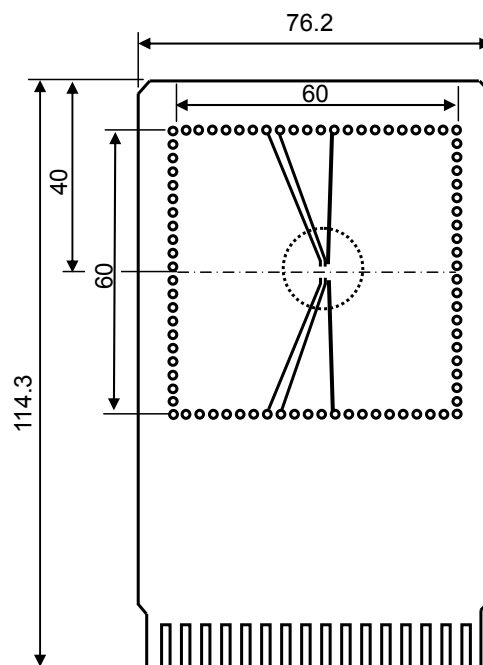
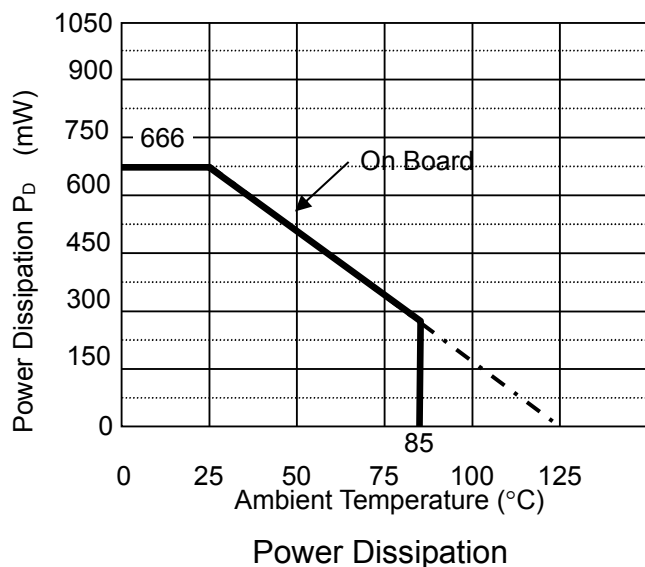

Measurement Board Pattern

○ IC Mount Area (Unit : mm)

PACKAGE DIMENSIONS (DFN(PLP)1212-6F)

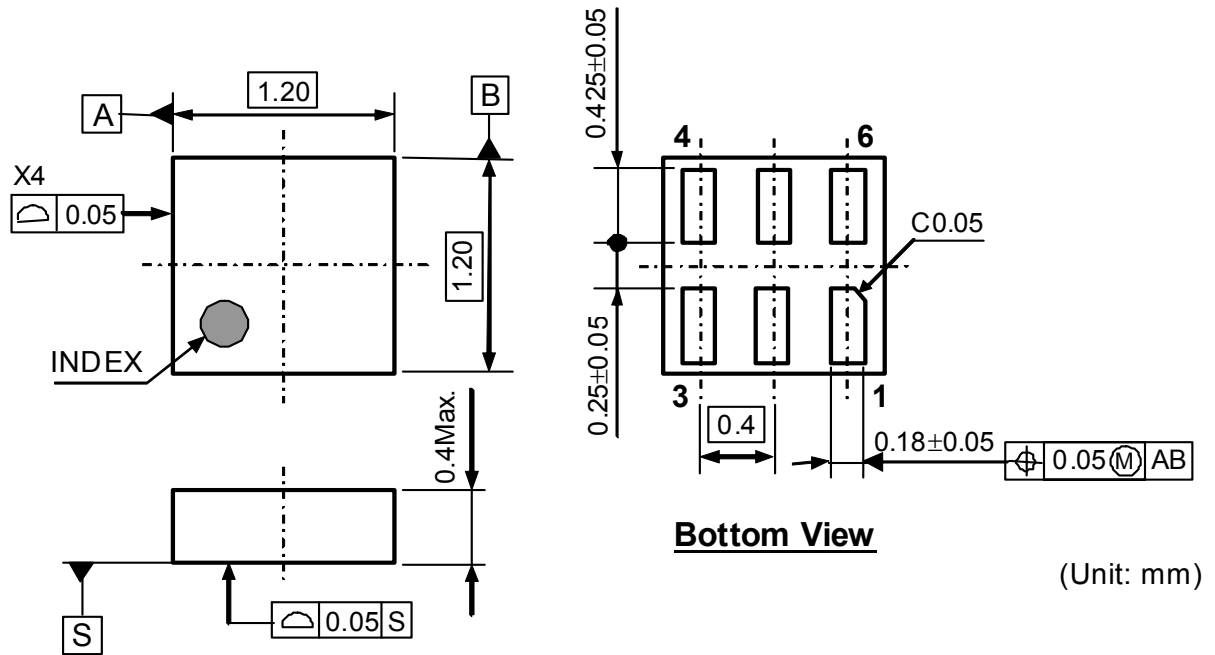

DFN (PLP) 1212-6F Package Dimensions

MARK SPECIFICATION (DFN(PLP)1212-6F)

- ①②: Product Code ... Refer to MARK SPECIFICATION TABLE (DFN(PLP)1212-6F)
- ③④: Lot Number ... Alphanumeric Serial Number

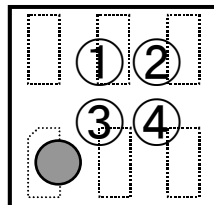

DFN (PLP) 1212-6F Mark Specification

**MARK SPECIFICATION TABLE (DFN(PLP)1212-6F)**

<b>RP508Kxx1A</b>		<b>RP508Kxx1B</b>	
<b>Product Name</b>	<b>①②</b>	<b>Product Name</b>	<b>①②</b>
RP508K081A	<b>AA</b>	RP508K081B	<b>DA</b>
RP508K091A	<b>AC</b>	RP508K091B	<b>DC</b>
RP508K101A	<b>AE</b>	RP508K101B	<b>DE</b>
RP508K101A5	<b>AF</b>	RP508K101B5	<b>DF</b>
RP508K111A	<b>AG</b>	RP508K111B	<b>DG</b>
RP508K121A	<b>AJ</b>	RP508K121B	<b>DJ</b>
RP508K121A5	<b>AK</b>	RP508K121B5	<b>DK</b>
RP508K131A	<b>AL</b>	RP508K131B	<b>DL</b>
RP508K131A5	<b>AM</b>	RP508K131B5	<b>DM</b>
RP508K141A	<b>AN</b>	RP508K141B	<b>DN</b>
RP508K151A	<b>AR</b>	RP508K151B	<b>DR</b>
RP508K161A	<b>AT</b>	RP508K161B	<b>DT</b>
RP508K171A	<b>AV</b>	RP508K171B	<b>DV</b>
RP508K181A	<b>AX</b>	RP508K181B	<b>DX</b>
RP508K191A	<b>AZ</b>	RP508K191B	<b>DZ</b>
RP508K201A	<b>BB</b>	RP508K201B	<b>EB</b>
RP508K211A	<b>BD</b>	RP508K211B	<b>ED</b>
RP508K221A	<b>BF</b>	RP508K221B	<b>EF</b>
RP508K231A	<b>BH</b>	RP508K231B	<b>EH</b>
RP508K241A	<b>BK</b>	RP508K241B	<b>EK</b>
RP508K251A	<b>BM</b>	RP508K251B	<b>EM</b>
RP508K261A	<b>BP</b>	RP508K261B	<b>EP</b>
RP508K271A	<b>BS</b>	RP508K271B	<b>ES</b>
RP508K281A	<b>BU</b>	RP508K281B	<b>EU</b>
RP508K291A	<b>BW</b>	RP508K291B	<b>EW</b>
RP508K301A	<b>BY</b>	RP508K301B	<b>EY</b>
RP508K311A	<b>CA</b>	RP508K311B	<b>FA</b>
RP508K321A	<b>CC</b>	RP508K321B	<b>FC</b>
RP508K331A	<b>CE</b>	RP508K331B	<b>FE</b>

# TYPICAL CHARACTERISTICS

## 01) Output Voltage vs. Output Current

RP508K081x,  $V_{OUT} = 0.8\text{ V}$

MODE = "L" PWM/VFM auto switching control

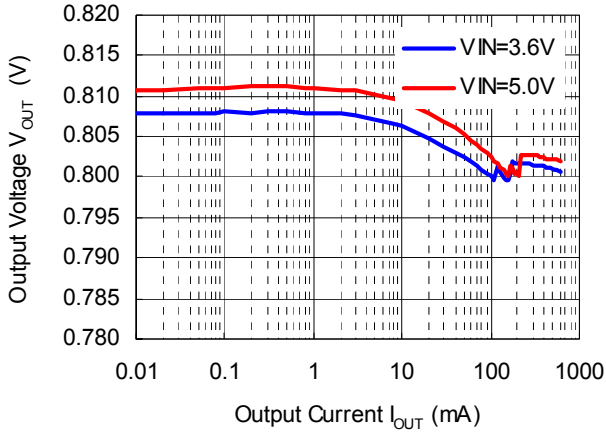

RP508K081x,  $V_{OUT} = 0.8\text{ V}$

MODE = "H" forced PWM control

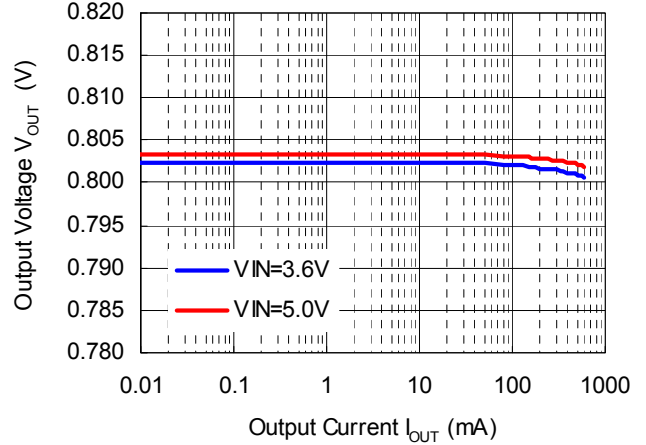

RP508K101x,  $V_{OUT} = 1.0\text{ V}$

MODE = "L" PWM/VFM auto switching control

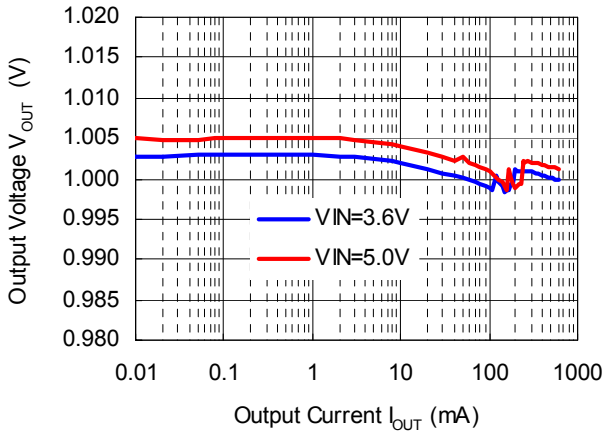

RP508K101x,  $V_{OUT} = 1.0\text{ V}$

MODE = "H" forced PWM control

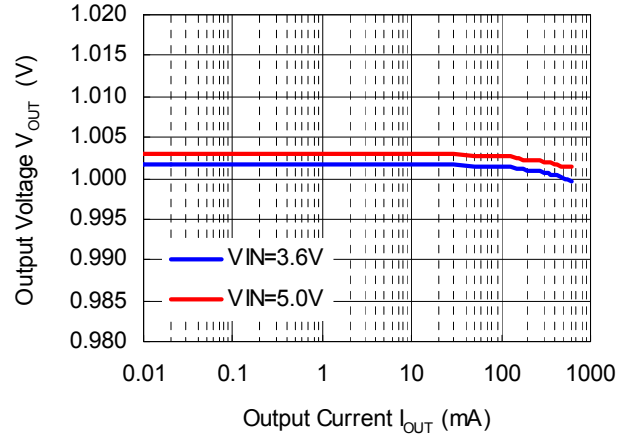

RP508K121x,  $V_{OUT} = 1.2\text{ V}$

MODE = "L" PWM/VFM auto switching control

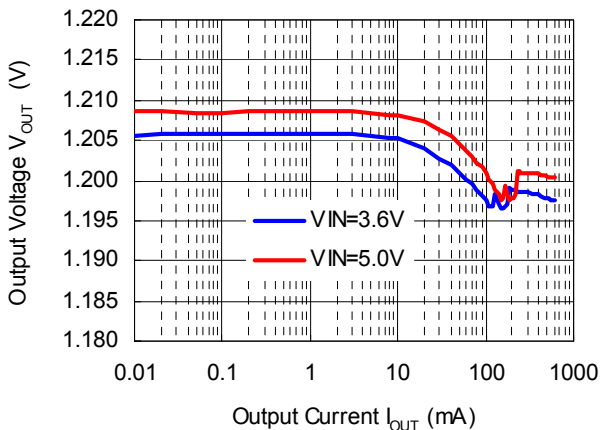

RP508K121x,  $V_{OUT} = 1.2\text{ V}$

MODE = "H" forced PWM control

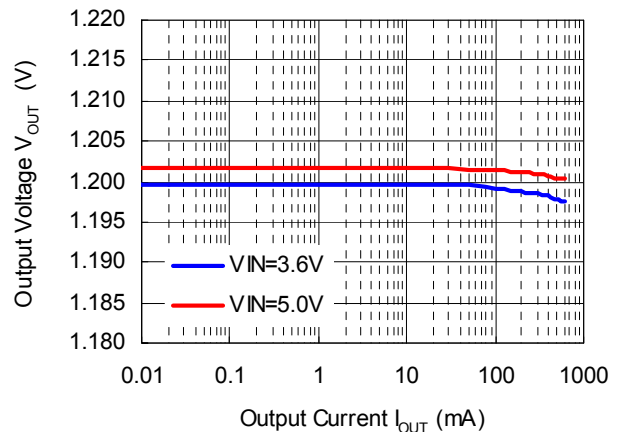

RP508K181x,  $V_{OUT} = 1.8\text{ V}$   
 MODE = "L" PWM/VFM auto switching control

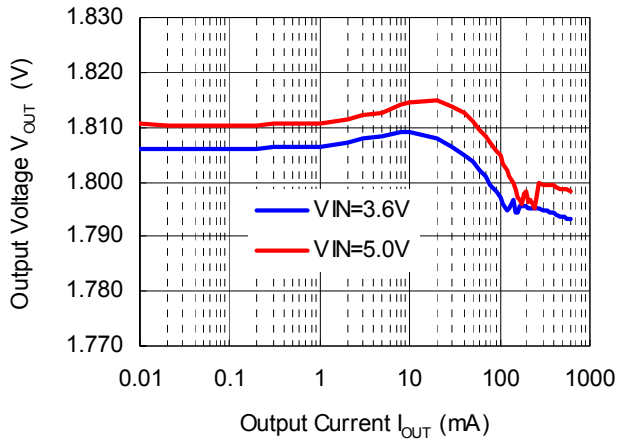

RP508K181x,  $V_{OUT} = 1.8\text{ V}$   
 MODE = "H" forced PWM control

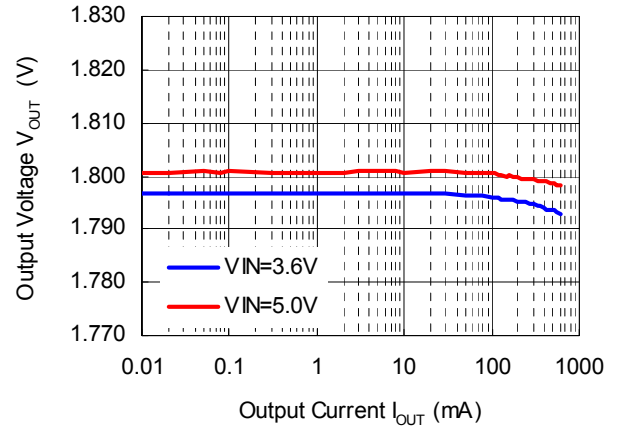

RP508K331x,  $V_{OUT} = 3.3\text{ V}$   
 MODE = "L" PWM/VFM auto switching control

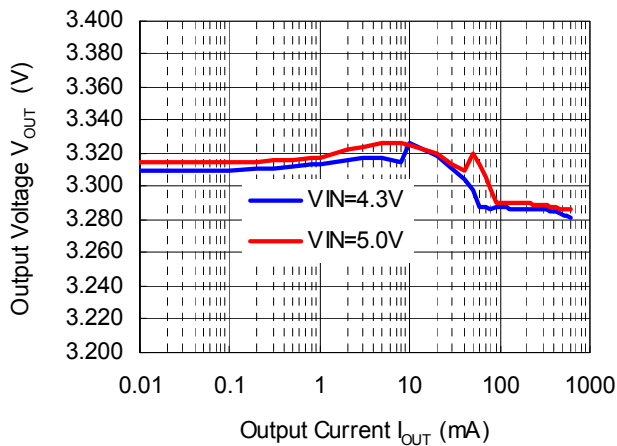

RP508K331x,  $V_{OUT} = 3.3\text{ V}$   
 MODE = "H" forced PWM control

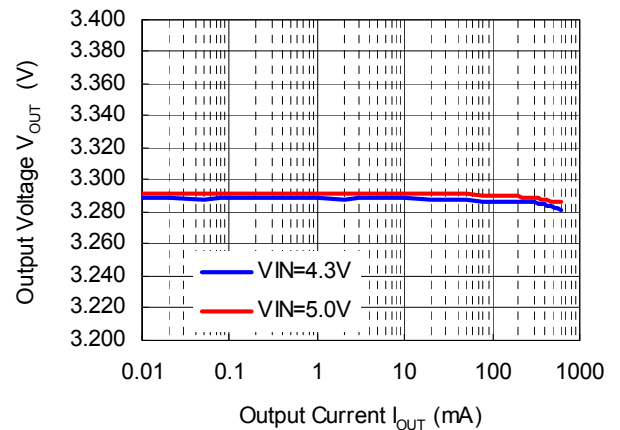

**02) Output Voltage vs. Input Voltage**

RP508K081x,  $V_{OUT} = 0.8\text{ V}$   
 MODE = "H" forced PWM control

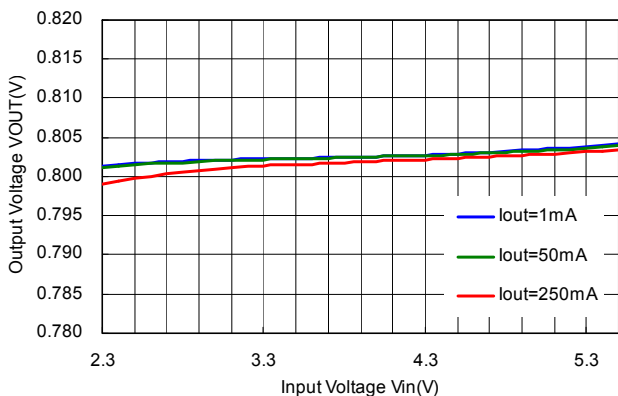

RP508K101x,  $V_{OUT} = 1.0\text{ V}$   
 MODE = "H" forced PWM control

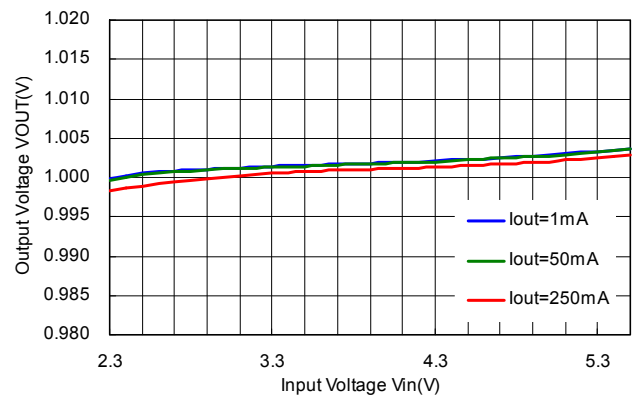

RP508K121x,  $V_{OUT} = 1.2\text{ V}$   
 MODE = "H" forced PWM control

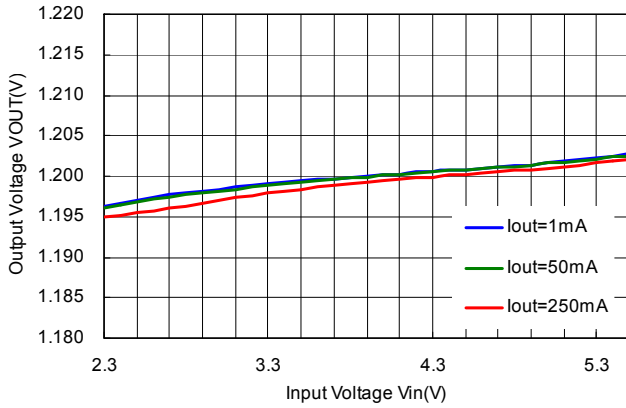

RP508K181x,  $V_{OUT} = 1.8\text{ V}$   
 MODE = "H" forced PWM control

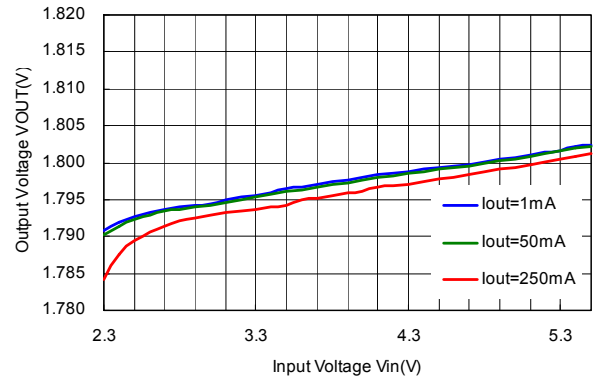

RP508K331x,  $V_{OUT} = 3.3\text{ V}$   
 MODE = "H" forced PWM control

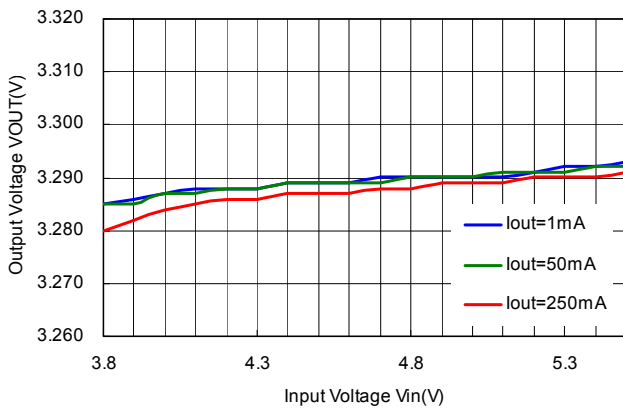

### 03) Output Voltage vs. Temperature

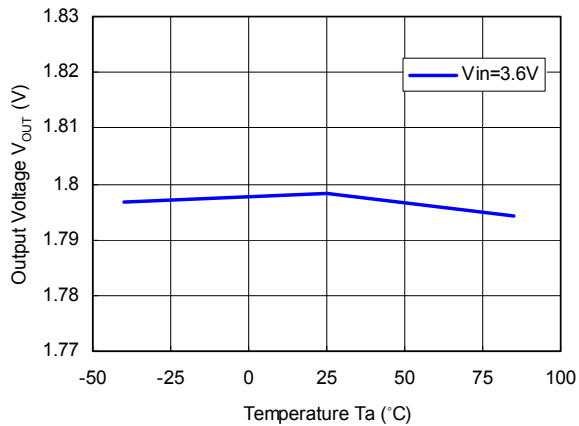

04) Efficiency vs. Output Current

RP508K081x,  $V_{OUT} = 0.8\text{ V}$   
 L = MIPSZ2012D0R5 (2012size\_0.5  $\mu\text{H}$ )

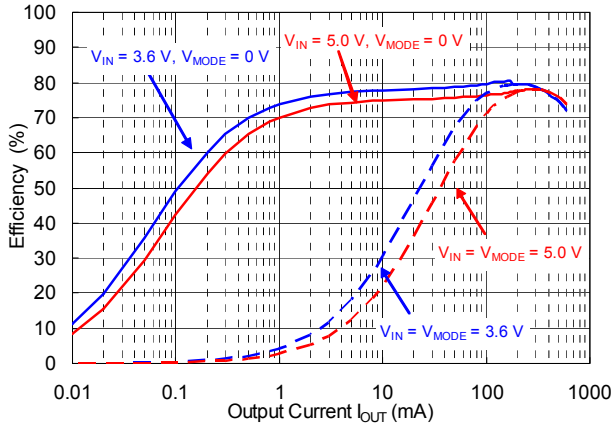

RP508K101x,  $V_{OUT} = 1.0\text{ V}$   
 L = MIPSZ2012D0R5 (2012size\_0.5  $\mu\text{H}$ )

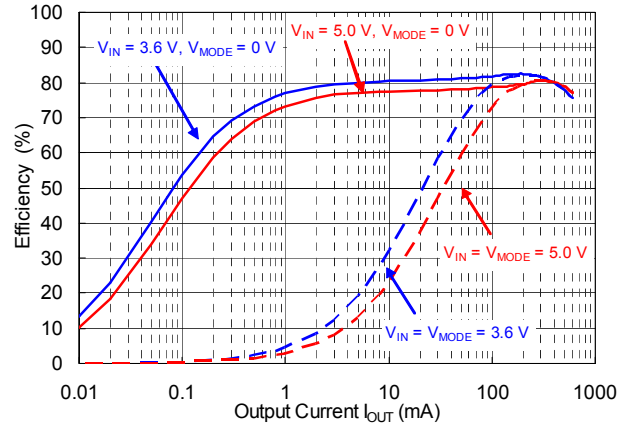

RP508K121x,  $V_{OUT} = 1.2\text{ V}$   
 L = MIPSZ2012D0R5 (2012size\_0.5  $\mu\text{H}$ )

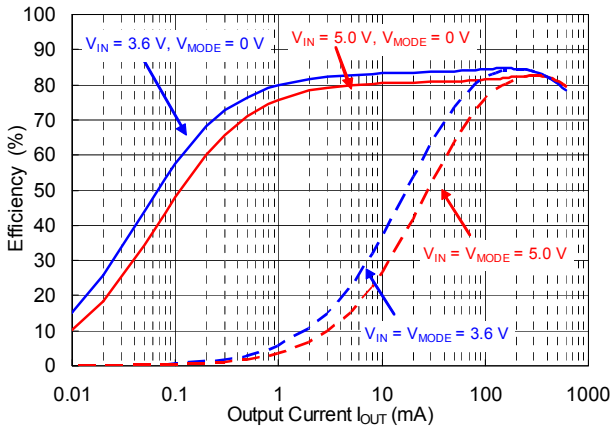

RP508K181x,  $V_{OUT} = 1.8\text{ V}$   
 L = MIPSZ2012D0R5 (2012size\_0.5  $\mu\text{H}$ )

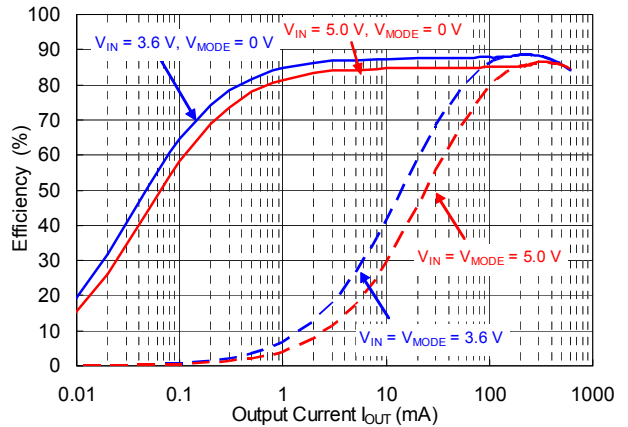

RP508K331x,  $V_{OUT} = 3.3\text{ V}$   
 L = MIPSZ2012D1R0 (2012size\_1.0  $\mu\text{H}$ )

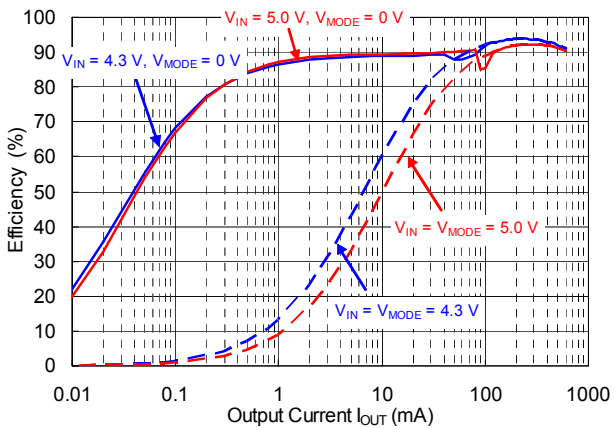



RP508K081x,  $V_{OUT} = 0.8\text{ V}$   
 $L = \text{MDT1608CHR47N}$  (1608size\_0.47  $\mu\text{H}$ )

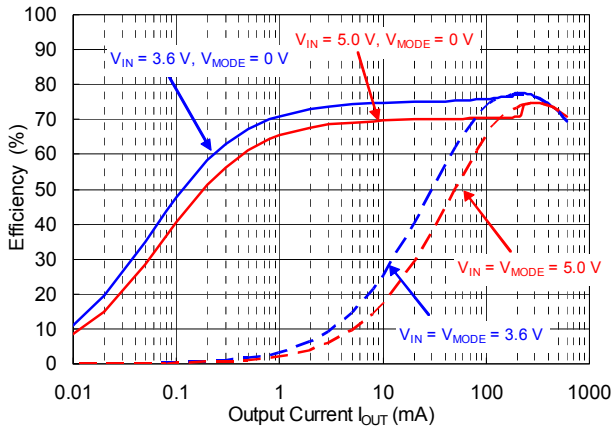

RP508K101x,  $V_{OUT} = 1.0\text{ V}$   
 $L = \text{MDT1608CHR47N}$  (1608size\_0.47  $\mu\text{H}$ )

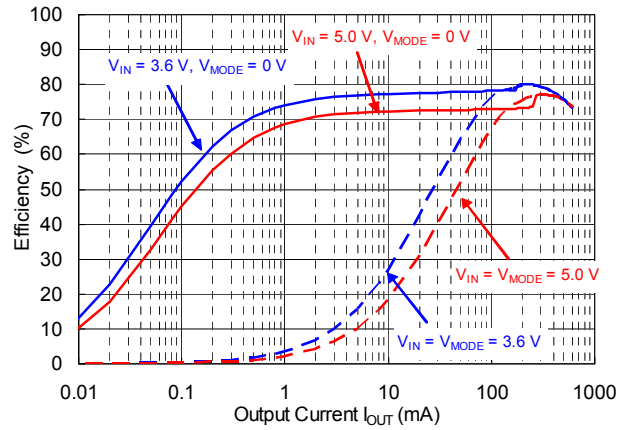

RP508K121x,  $V_{OUT} = 1.2\text{ V}$   
 $L = \text{MDT1608CHR47N}$  (1608size\_0.47  $\mu\text{H}$ )

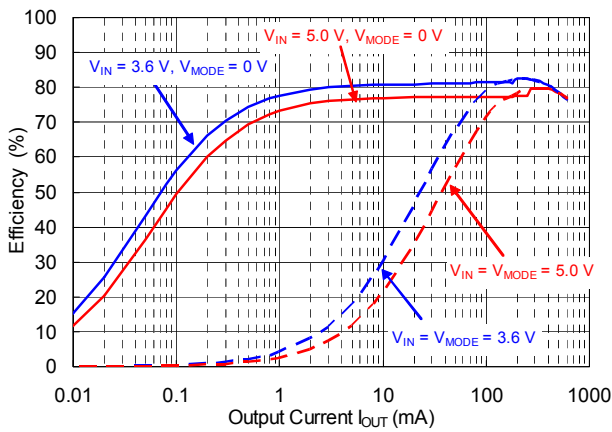

RP508K181x,  $V_{OUT} = 1.8\text{ V}$   
 $L = \text{MDT1608CHR47N}$  (1608size\_0.47  $\mu\text{H}$ )

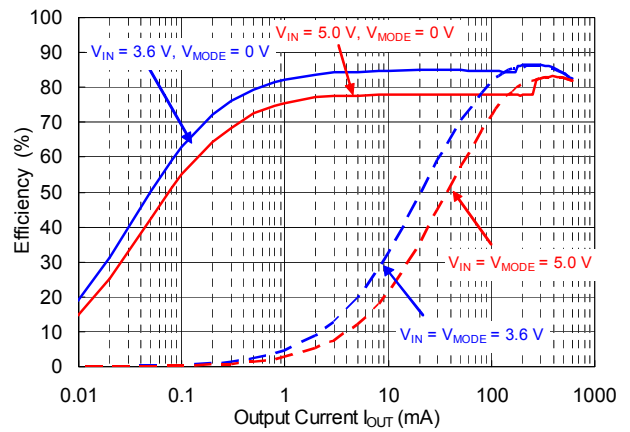

RP508K331x,  $V_{OUT} = 3.3\text{ V}$   
 $L = \text{MDT1608CH1R0N}$  (1608size\_1.0  $\mu\text{H}$ )

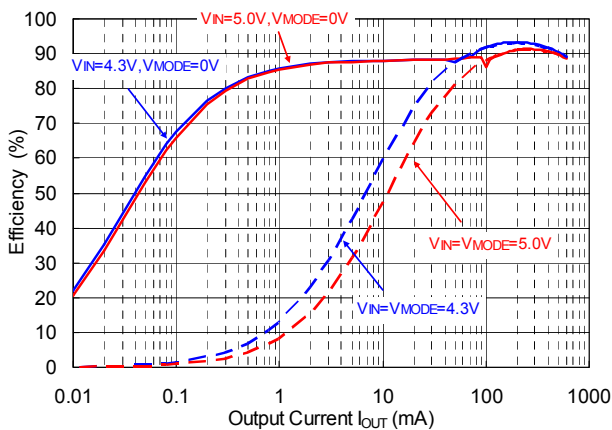

**05) Supply Current vs. Temperature**

RP508K181x,  $V_{OUT} = 1.8\text{ V}$  ( $V_{IN} = 5.5\text{ V}$ )  
 MODE = "L" PWM/VFM auto switching control

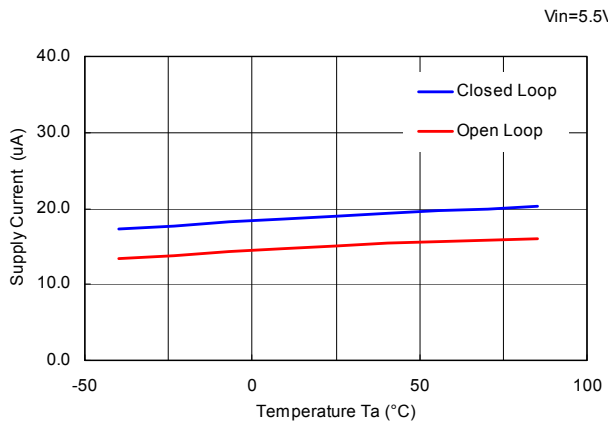

**06) Supply Current vs. Input Voltage**

RP508K181x,  $V_{OUT} = 1.8\text{ V}$   
 MODE = "L" PWM/VFM auto switching control

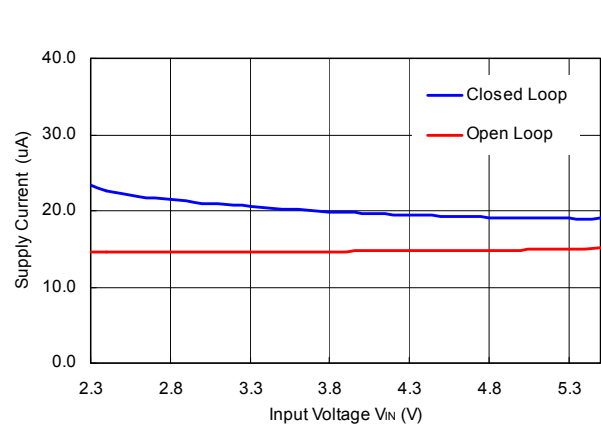

**07) Output Voltage Waveform**

RP508K081x,  $V_{OUT} = 0.8\text{ V}$  ( $V_{IN} = 3.6\text{ V}$ )  
 MODE = "L" PWM/VFM auto switching control

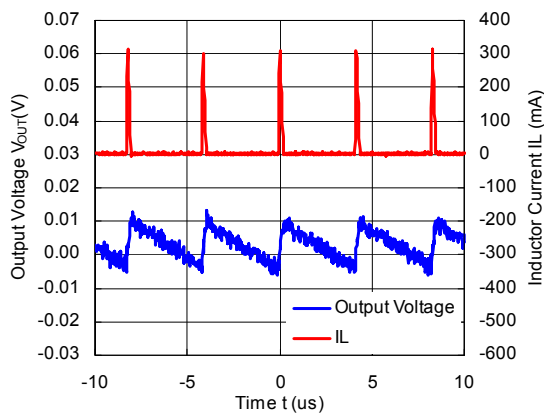

RP508K081x,  $V_{OUT} = 0.8\text{ V}$  ( $V_{IN} = 3.6\text{ V}$ )  
 MODE = "H" forced PWM control

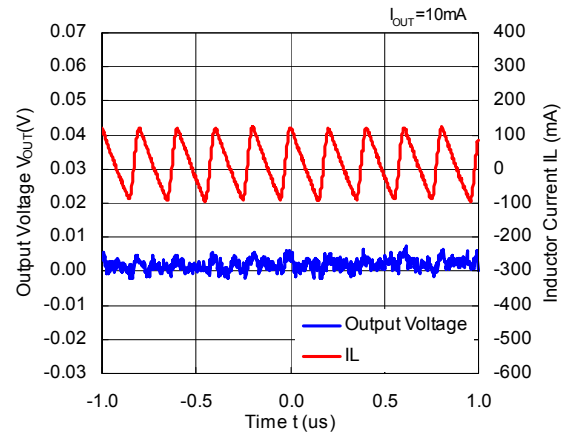

RP508K121x,  $V_{OUT} = 1.2\text{ V}$  ( $V_{IN} = 3.6\text{ V}$ )  
 MODE = "L" PWM/VFM auto switching control

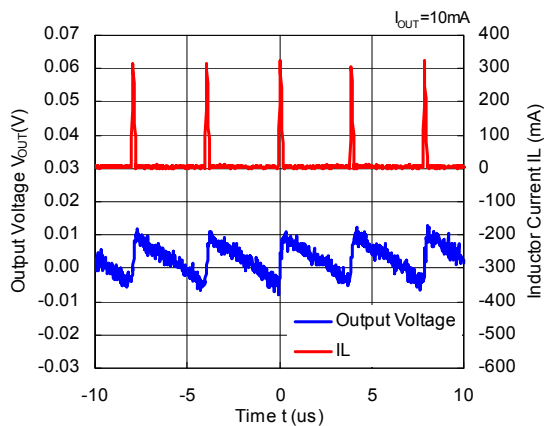

RP508K121x,  $V_{OUT} = 1.2\text{ V}$  ( $V_{IN} = 3.6\text{ V}$ )  
 MODE = "H" forced PWM control

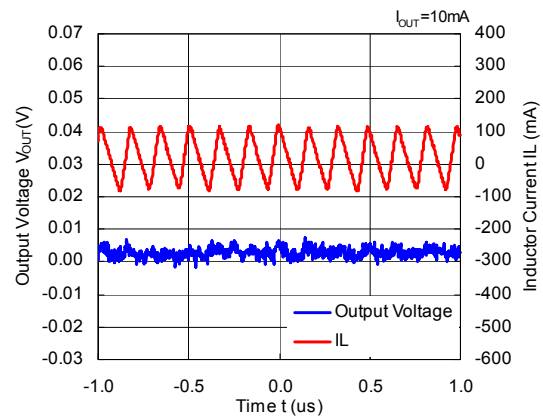

RP508K181x,  $V_{OUT} = 1.8\text{ V}$  ( $V_{IN} = 3.6\text{ V}$ )  
 MODE = "L" PWM/VFM auto switching control

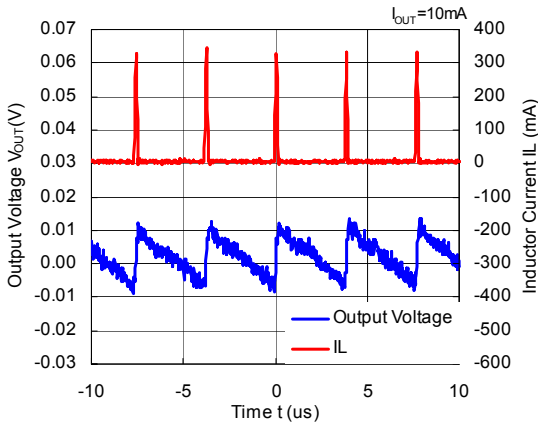

RP508K181x,  $V_{OUT} = 1.8\text{ V}$  ( $V_{IN} = 3.6\text{ V}$ )  
 MODE = "H" forced PWM control

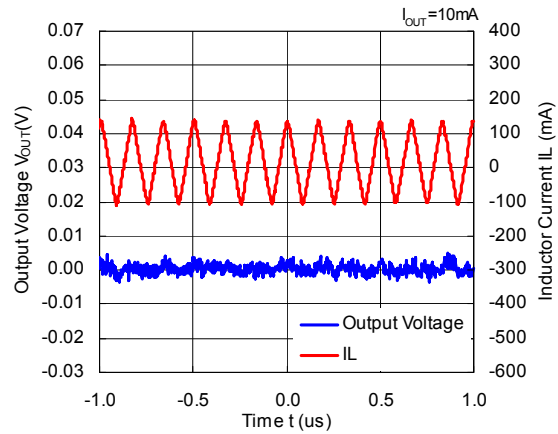

RP508K331x,  $V_{OUT} = 3.3\text{ V}$  ( $V_{IN} = 4.3\text{ V}$ )  
 MODE = "L" PWM/VFM auto switching control

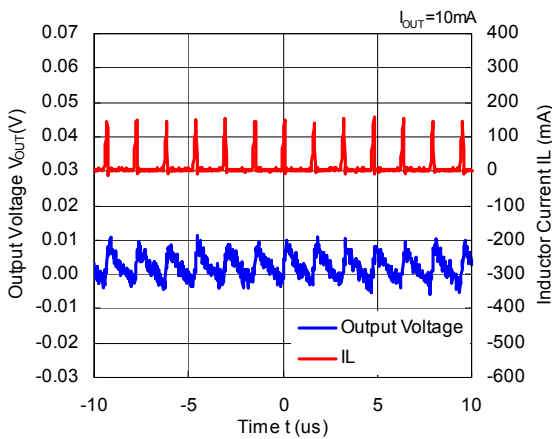

RP508K331x,  $V_{OUT} = 3.3\text{ V}$  ( $V_{IN} = 4.3\text{ V}$ )  
 MODE = "H" forced PWM control

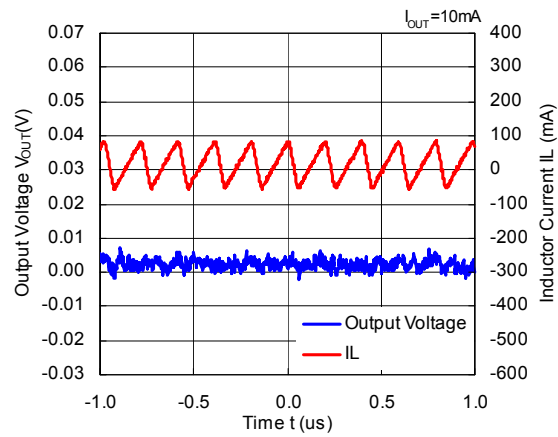

**08) Frequency vs. Input Voltage**

RP508K181x,  $V_{OUT} = 1.8\text{ V}$   
 MODE = "H" forced PWM control

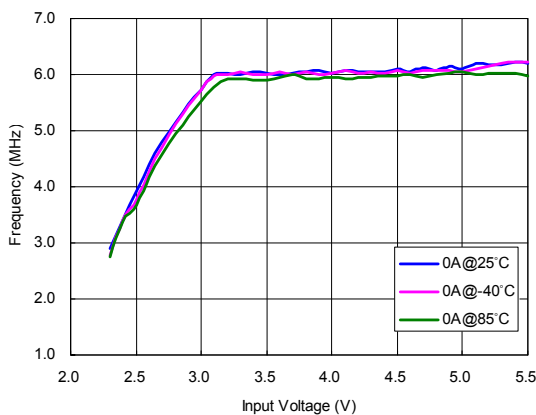

**09) Frequency vs. Input Voltage with Various Output Currents**

RP508K121x,  $V_{OUT} = 1.2\text{ V}$   
 MODE = "H" forced PWM control

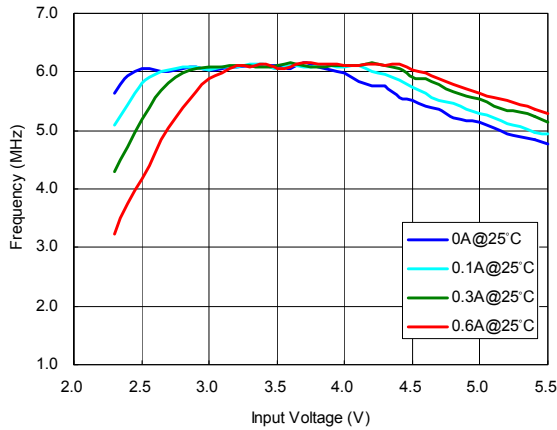

RP508K181x,  $V_{OUT} = 1.8\text{ V}$   
 MODE = "H" forced PWM control

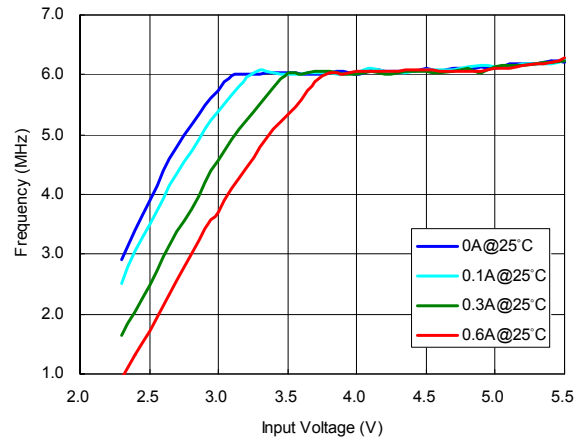

**10) VFM Frequency vs. Output Current**

RP508K121x,  $V_{OUT} = 1.2\text{ V}$   
 MODE = "L" PWM/VFM auto switching control

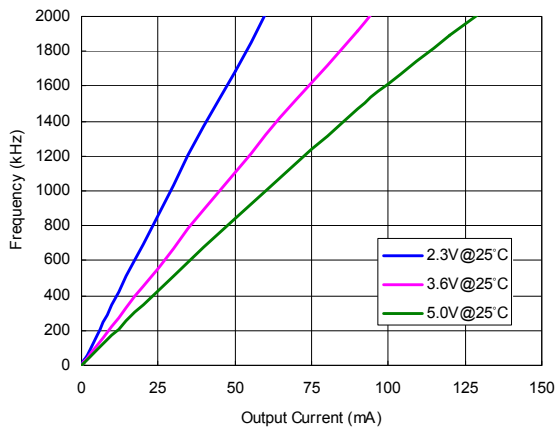

RP508K181x,  $V_{OUT} = 1.8\text{ V}$   
 MODE = "L" PWM/VFM auto switching control

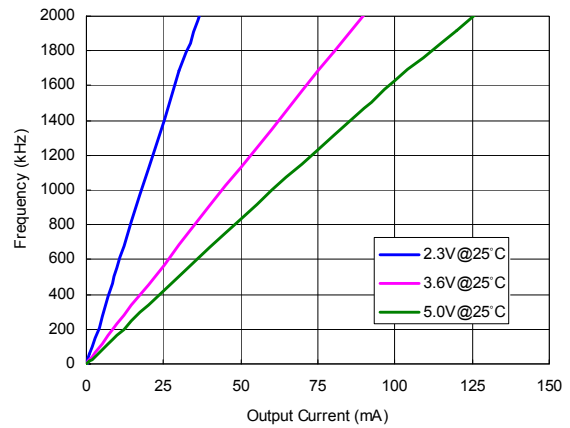

**11) Soft-start Time vs. Temperature**

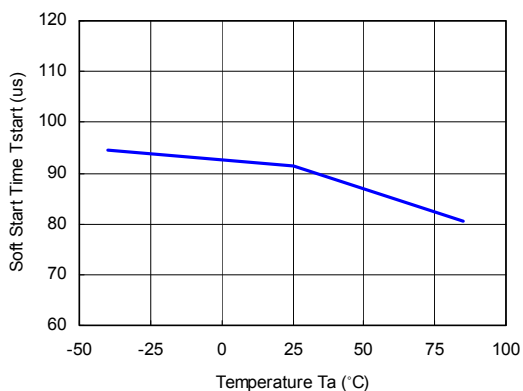

12) UVLO Detector Threshold/ Released Voltage vs. Temperature

UVLO Detector Threshold

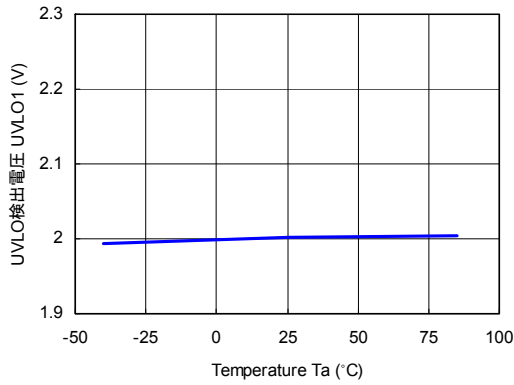

UVLO Release Voltage

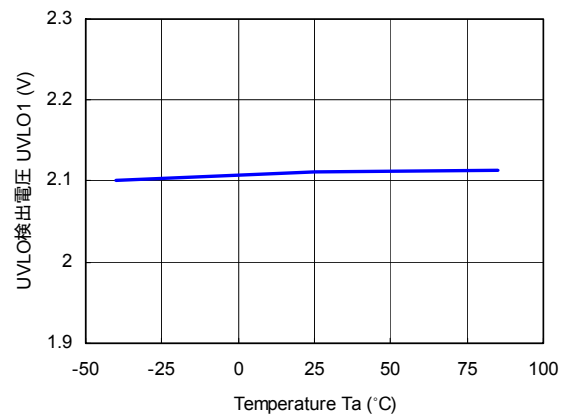

13) CE Input Voltage vs. Temperature

CE = "H" Input Voltage (VIN = 5.5 V)

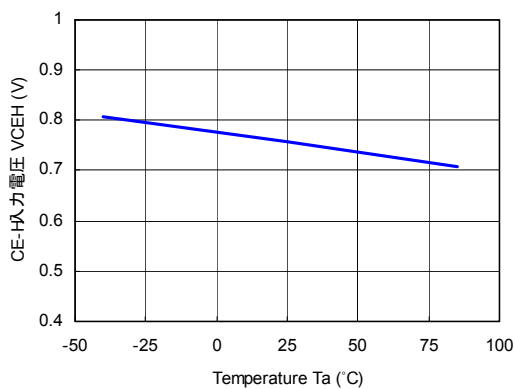

CE = "H" Input Voltage (VIN = 2.3 V)

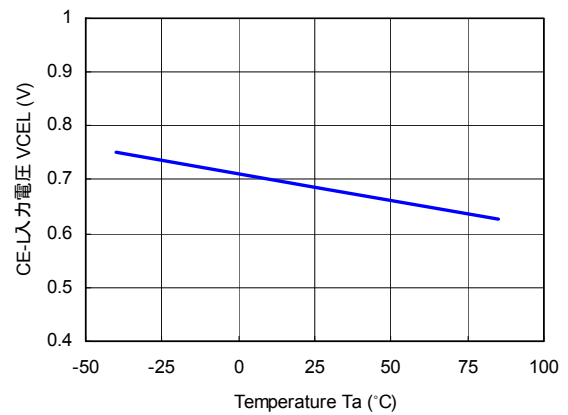

14) Lx Current Limit vs. Temperature

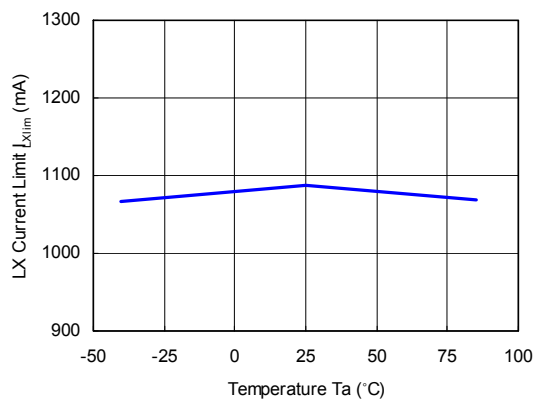

15) Standby Current vs. Temperature

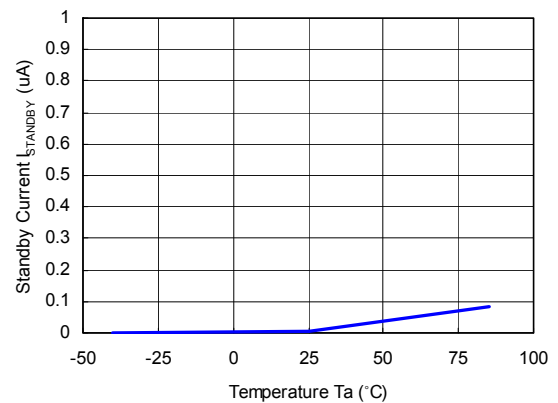

16) Nch Transistor On Resistance vs. Temperature 17) Pch Transistor On Resistance vs. Temperature

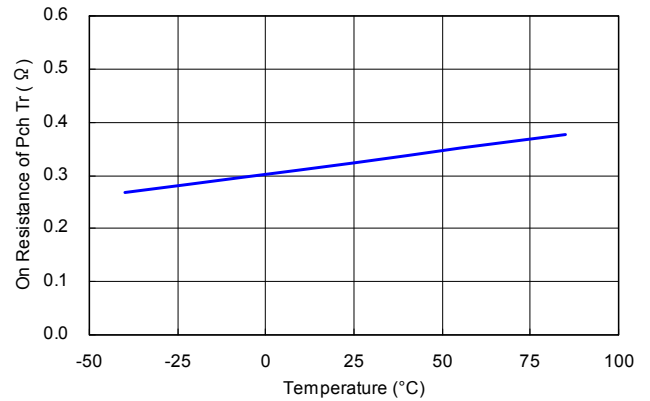
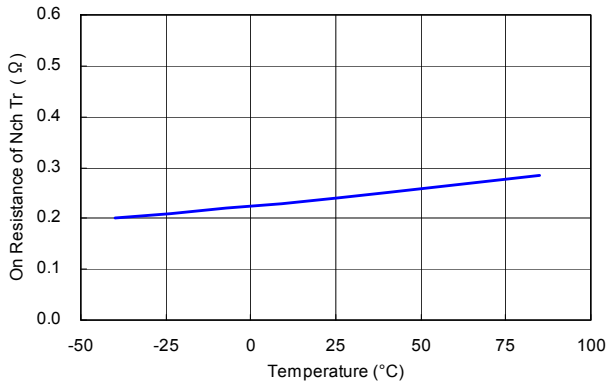

18) Load Transient Response (C<sub>OUT</sub> = 4.7 μF, C1005X5R0J475M)

RP508K081x (V<sub>IN</sub> = 3.6 V, V<sub>OUT</sub> = 0.8 V)  
 L = MIPSZ2012D0R5 (2012size\_0.5 μH)  
 MODE = "H" forced PWM control

RP508K081x (V<sub>IN</sub> = 3.6 V, V<sub>OUT</sub> = 0.8 V)  
 L = MIPSZ2012D0R5 (2012size\_0.5 μH)  
 MODE = "H" forced PWM control

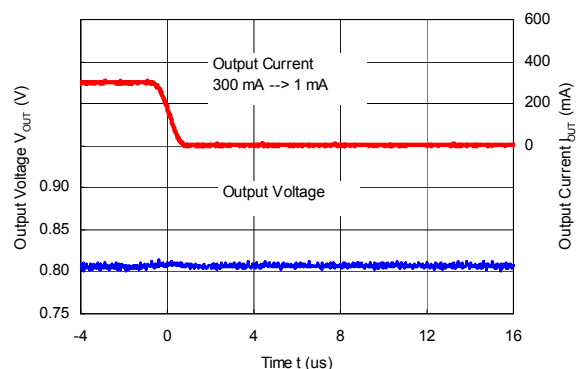
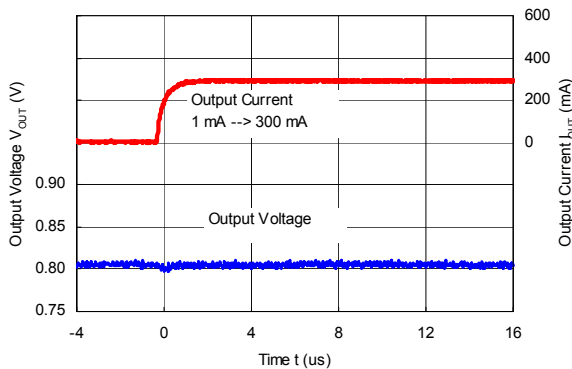

RP508K081x (V<sub>IN</sub> = 3.6 V, V<sub>OUT</sub> = 0.8 V)  
 L = MIPSZ2012D0R5 (2012size\_0.5 μH)  
 MODE = "H" forced PWM control

RP508K081x (V<sub>IN</sub> = 3.6 V, V<sub>OUT</sub> = 0.8 V)  
 L = MIPSZ2012D0R5 (2012size\_0.5 μH)  
 MODE = "H" forced PWM control

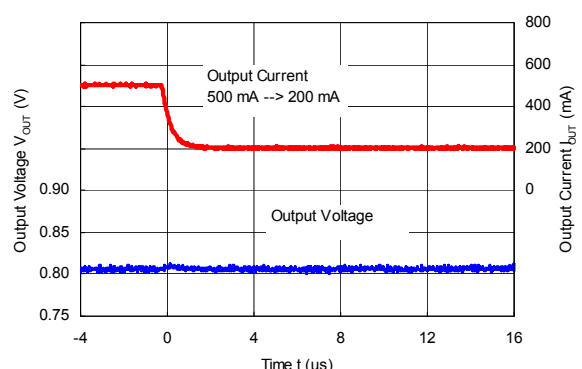
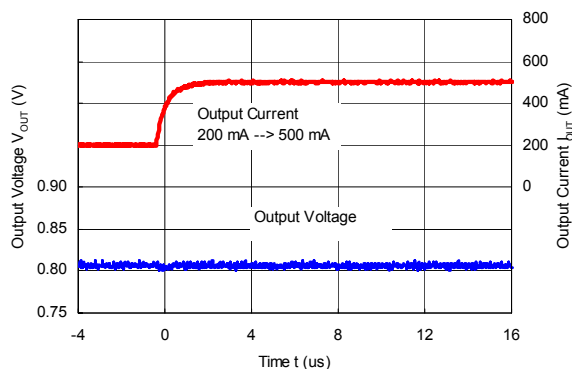

RP508K121x ( $V_{IN} = 3.6\text{ V}$ ,  $V_{OUT} = 1.2\text{ V}$ )  
 L = MIPSZ2012D0R5 (2012size\_0.5  $\mu\text{H}$ )  
 MODE = "H" forced PWM control

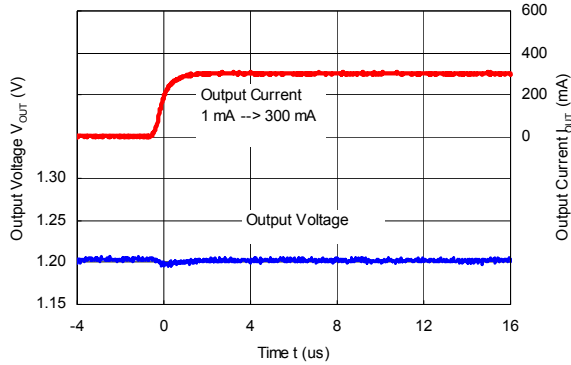

RP508K121x ( $V_{IN} = 3.6\text{ V}$ ,  $V_{OUT} = 1.2\text{ V}$ )  
 L = MIPSZ2012D0R5 (2012size\_0.5  $\mu\text{H}$ )  
 MODE = "H" forced PWM control

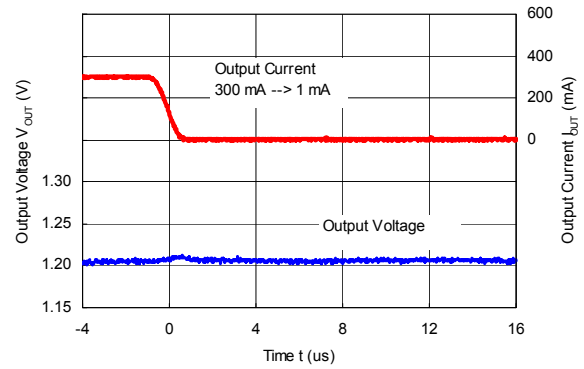

RP508K121x ( $V_{IN} = 3.6\text{ V}$ ,  $V_{OUT} = 1.2\text{ V}$ )  
 L = MIPSZ2012D0R5 (2012size\_0.5  $\mu\text{H}$ )  
 MODE = "H" forced PWM control

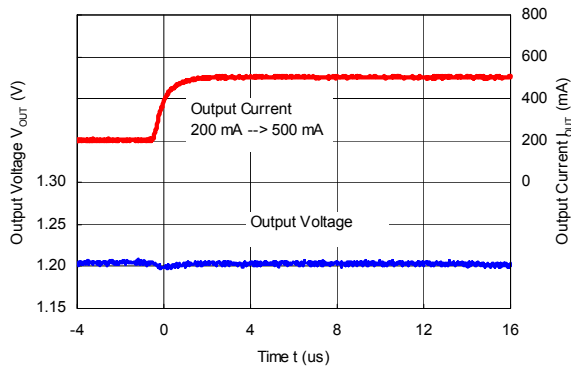

RP508K121x ( $V_{IN} = 3.6\text{ V}$ ,  $V_{OUT} = 1.2\text{ V}$ )  
 L = MIPSZ2012D0R5 (2012size\_0.5  $\mu\text{H}$ )  
 MODE = "H" forced PWM control

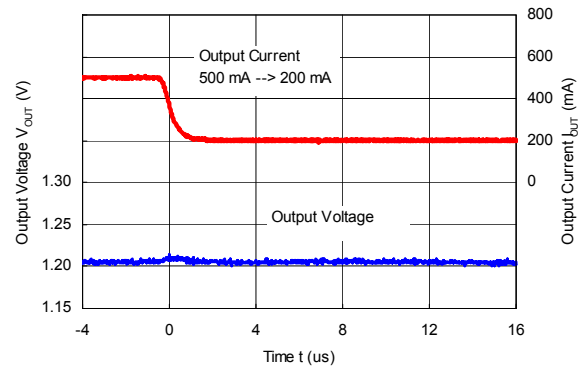

RP508K181x ( $V_{IN} = 3.6\text{ V}$ ,  $V_{OUT} = 1.8\text{ V}$ )  
 L = MIPSZ2012D0R5 (2012size\_0.5  $\mu\text{H}$ )  
 MODE = "H" forced PWM control

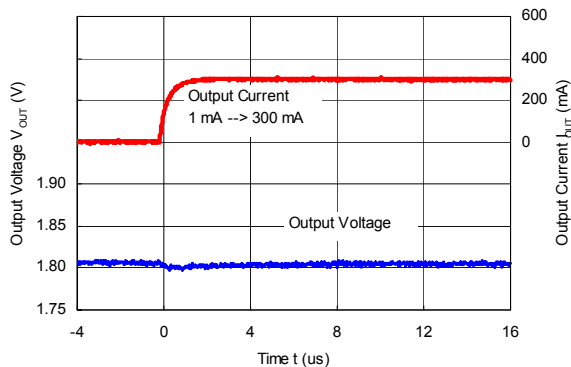

RP508K181x ( $V_{IN} = 3.6\text{ V}$ ,  $V_{OUT} = 1.8\text{ V}$ )  
 L = MIPSZ2012D0R5 (2012size\_0.5  $\mu\text{H}$ )  
 MODE = "H" forced PWM control

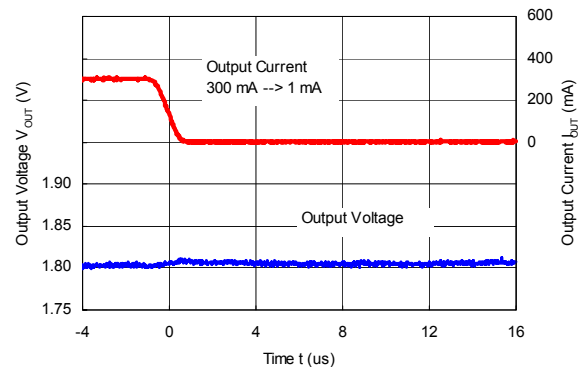

RP508K181x ( $V_{IN} = 3.6\text{ V}$ ,  $V_{OUT} = 1.8\text{ V}$ )  
 L = MIPSZ2012D0R5 (2012size\_0.5  $\mu\text{H}$ )  
 MODE = "H" forced PWM control

RP508K181x ( $V_{IN} = 3.6\text{ V}$ ,  $V_{OUT} = 1.8\text{ V}$ )  
 L = MIPSZ2012D0R5 (2012size\_0.5  $\mu\text{H}$ )  
 MODE = "H" forced PWM control

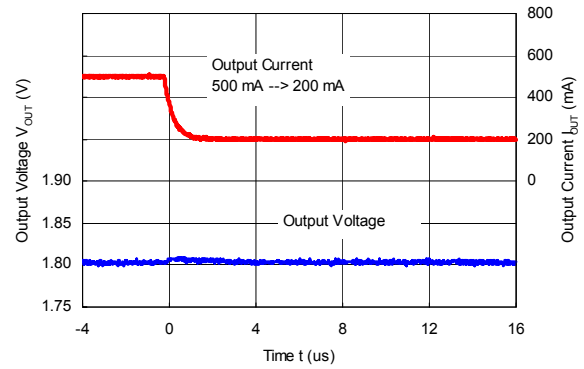
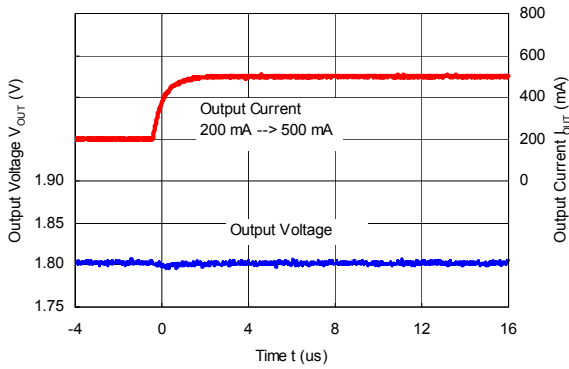

RP508K331x ( $V_{IN} = 5.0\text{ V}$ ,  $V_{OUT} = 3.3\text{ V}$ )  
 L = MIPSZ2012D1R0 (2012size\_1.0  $\mu\text{H}$ )  
 MODE = "H" forced PWM control

RP508K331x ( $V_{IN} = 5.0\text{ V}$ ,  $V_{OUT} = 3.3\text{ V}$ )  
 L = MIPSZ2012D1R0 (2012size\_1.0  $\mu\text{H}$ )  
 MODE = "H" forced PWM control

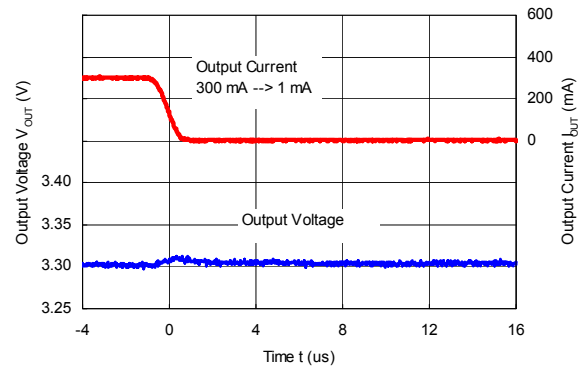
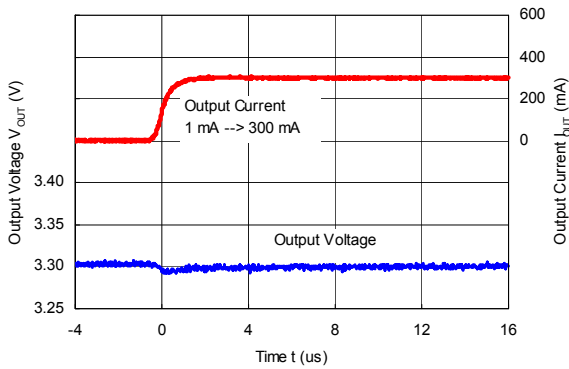

RP508K331x ( $V_{IN} = 5.0\text{ V}$ ,  $V_{OUT} = 3.3\text{ V}$ )  
 L = MIPSZ2012D1R0 (2012size\_1.0  $\mu\text{H}$ )  
 MODE = "H" forced PWM control

RP508K331x ( $V_{IN} = 5.0\text{ V}$ ,  $V_{OUT} = 3.3\text{ V}$ )  
 L = MIPSZ2012D1R0 (2012size\_1.0  $\mu\text{H}$ )  
 MODE = "H" forced PWM control

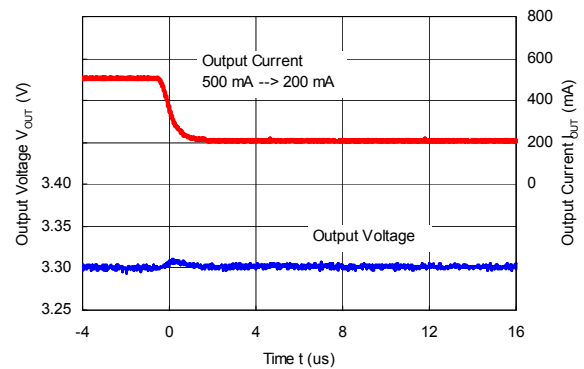
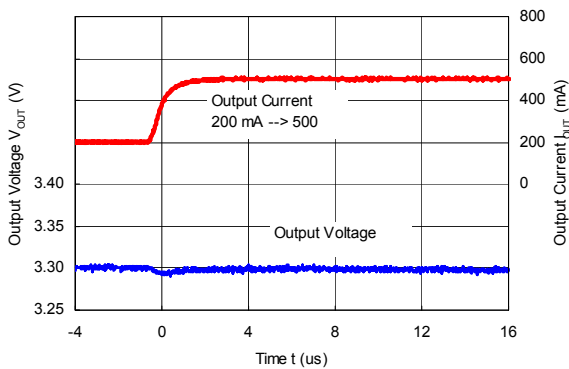



**Load Transient Response ( $C_{OUT} = 4.7\mu F, C1005X5R0J475M$ )**

RP508K081x ( $V_{IN} = 3.6 V, V_{OUT} = 0.8 V$ )  
 L = MIPSZ2012D0R5 (2012size\_0.5  $\mu H$ )  
 MODE = "L" PWM/VFM auto switching control

RP508K081x ( $V_{IN} = 3.6 V, V_{OUT} = 0.8 V$ )  
 L = MIPSZ2012D0R5 (2012size\_0.5  $\mu H$ )  
 MODE = "L" PWM/VFM auto switching control

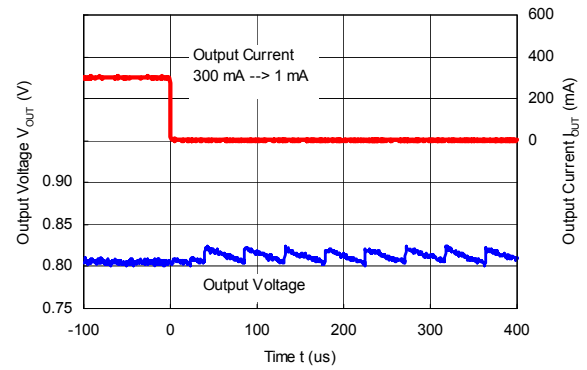
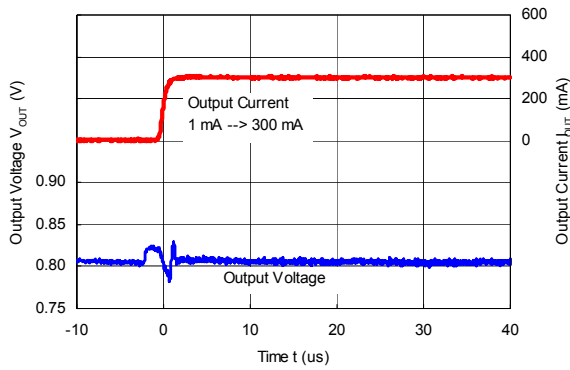

RP508K121x ( $V_{IN} = 3.6 V, V_{OUT} = 1.2 V$ )  
 L = MIPSZ2012D0R5 (2012size\_0.5  $\mu H$ )  
 MODE = "L" PWM/VFM auto switching control

RP508K121x ( $V_{IN} = 3.6 V, V_{OUT} = 1.2 V$ )  
 L = MIPSZ2012D0R5 (2012size\_0.5  $\mu H$ )  
 MODE = "L" PWM/VFM auto switching control

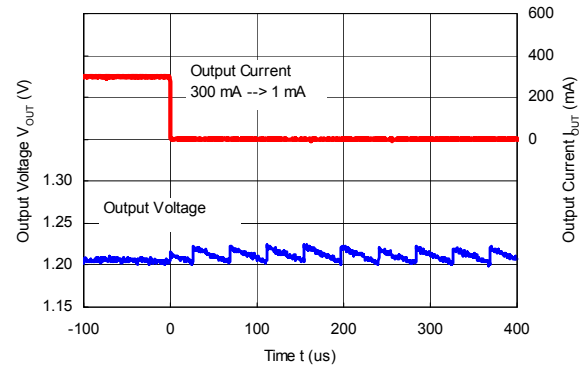
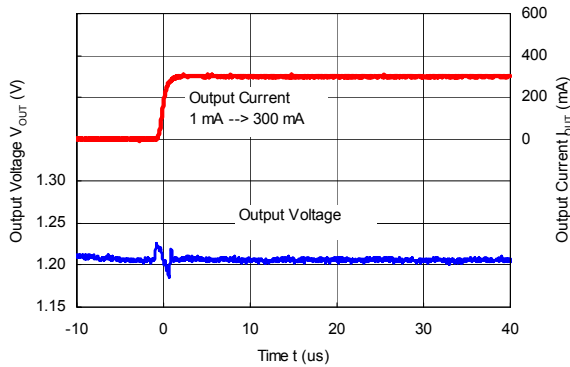

RP508K181x ( $V_{IN} = 3.6 V, V_{OUT} = 1.8 V$ )  
 L = MIPSZ2012D0R5 (2012size\_0.5  $\mu H$ )  
 MODE = "L" PWM/VFM auto switching control

RP508K181x ( $V_{IN} = 3.6 V, V_{OUT} = 1.8 V$ )  
 L = MIPSZ2012D0R5 (2012size\_0.5  $\mu H$ )  
 MODE = "L" PWM/VFM auto switching control

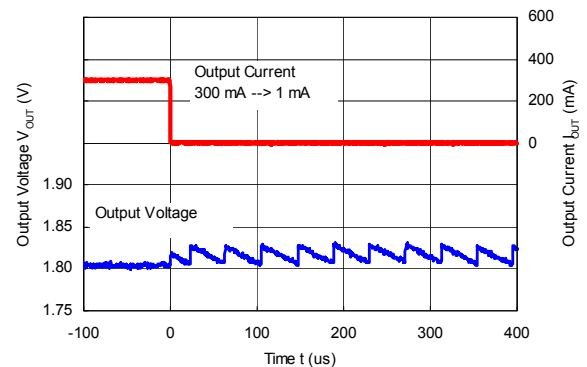
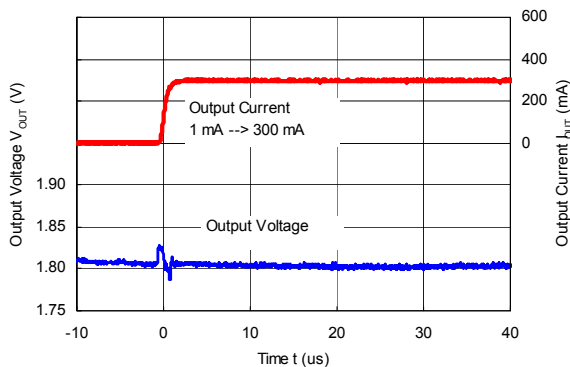

RP508K331x ( $V_{IN} = 5.0\text{ V}$ ,  $V_{OUT} = 3.3\text{ V}$ )  
 L = MIPSZ2012D1R0 (2012size\_1.0  $\mu\text{H}$ )  
 MODE = "L" PWM/VFM auto switching control

RP508K331x ( $V_{IN} = 5.0\text{ V}$ ,  $V_{OUT} = 3.3\text{ V}$ )  
 L = MIPSZ2012D1R0 (2012size\_1.0  $\mu\text{H}$ )  
 MODE = "L" PWM/VFM auto switching control

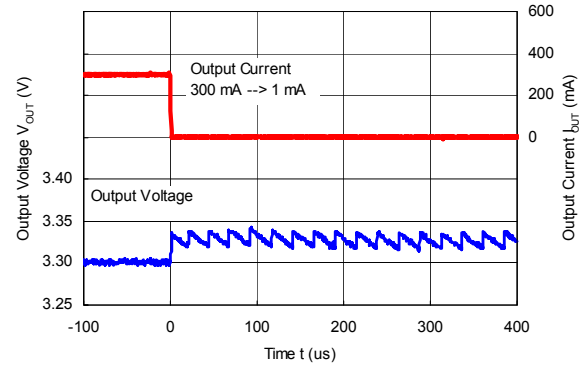
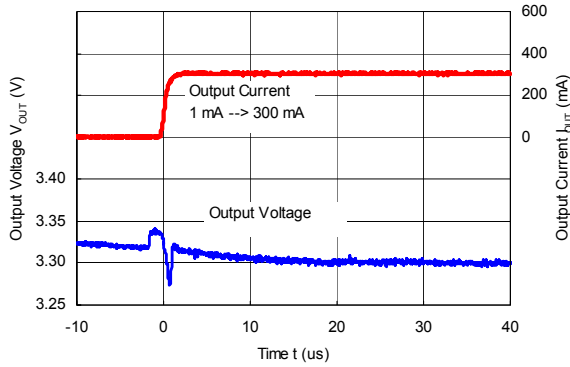

**Load Transient Response ( $C_{OUT} = 4.7\ \mu\text{F}$ , C1005X5R0J475M)**

RP508K081x ( $V_{IN} = 3.6\text{ V}$ ,  $V_{OUT} = 0.8\text{ V}$ )  
 L = MDT1608CHR47N (1608size\_0.47  $\mu\text{H}$ )  
 MODE = "H" forced PWM control

RP508K081x ( $V_{IN} = 3.6\text{ V}$ ,  $V_{OUT} = 0.8\text{ V}$ )  
 L = MDT1608CHR47N (1608size\_0.47  $\mu\text{H}$ )  
 MODE = "H" forced PWM control

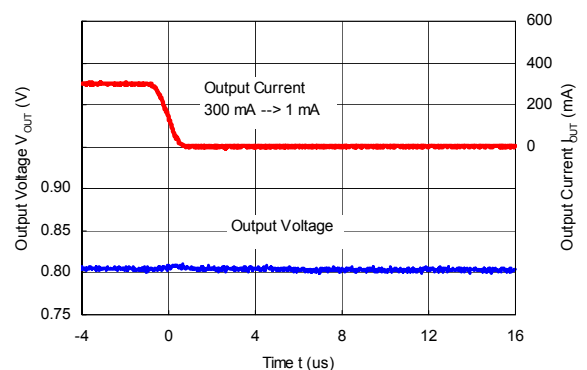
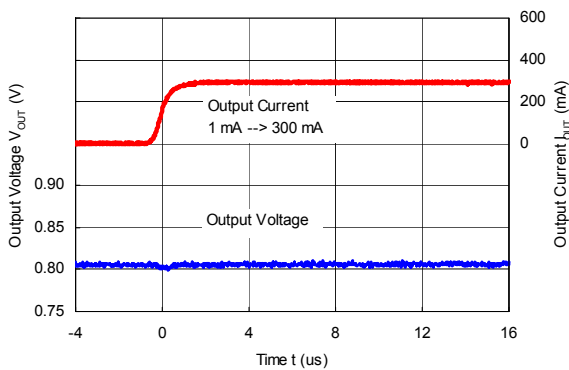

RP508K081x ( $V_{IN} = 3.6\text{ V}$ ,  $V_{OUT} = 0.8\text{ V}$ )  
 L = MDT1608CHR47N (1608size\_0.47  $\mu\text{H}$ )  
 MODE = "H" forced PWM control

RP508K081x ( $V_{IN} = 3.6\text{ V}$ ,  $V_{OUT} = 0.8\text{ V}$ )  
 L = MDT1608CHR47N (1608size\_0.47  $\mu\text{H}$ )  
 MODE = "H" forced PWM control

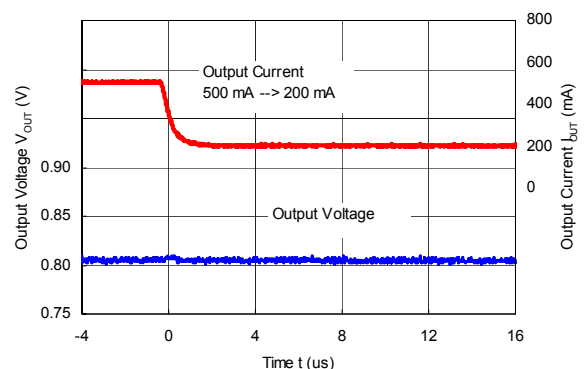
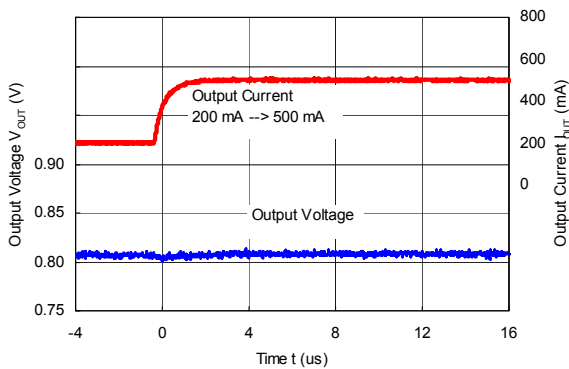

RP508K121x ( $V_{IN} = 3.6\text{ V}$ ,  $V_{OUT} = 1.2\text{ V}$ )  
 L = MDT1608CHR47N (1608size\_0.47  $\mu\text{H}$ )  
 MODE = "H" forced PWM control

RP508K121x ( $V_{IN} = 3.6\text{ V}$ ,  $V_{OUT} = 1.2\text{ V}$ )  
 L = MDT1608CHR47N (1608size\_0.47  $\mu\text{H}$ )  
 MODE = "H" forced PWM control

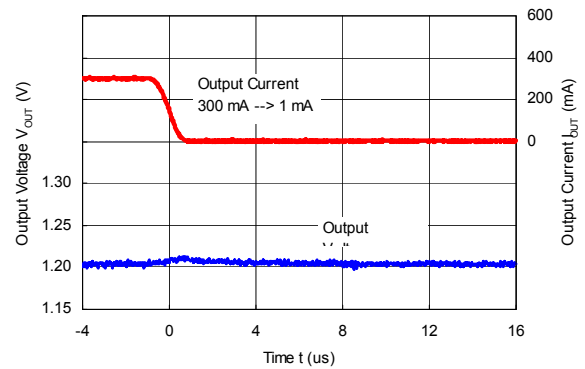
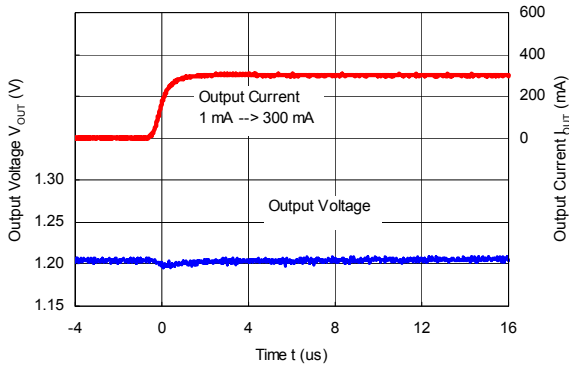

RP508K121x ( $V_{IN} = 3.6\text{ V}$ ,  $V_{OUT} = 1.2\text{ V}$ )  
 L = MDT1608CHR47N (1608size\_0.47  $\mu\text{H}$ )  
 MODE = "H" forced PWM control

RP508K121x ( $V_{IN} = 3.6\text{ V}$ ,  $V_{OUT} = 1.2\text{ V}$ )  
 L = MDT1608CHR47N (1608size\_0.47  $\mu\text{H}$ )  
 MODE = "H" forced PWM control

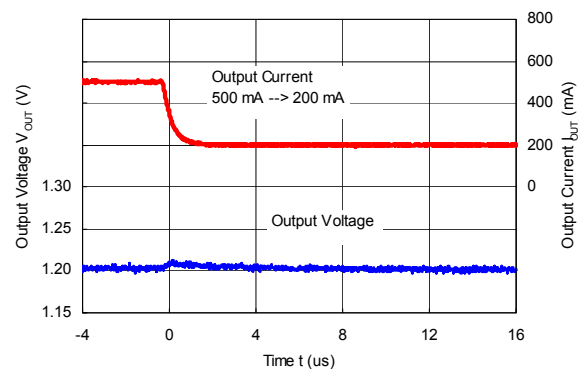
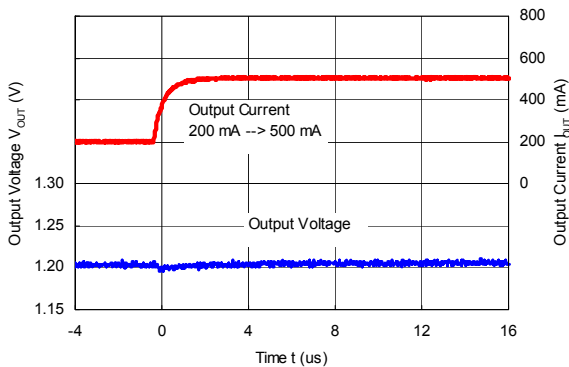

RP508K181x ( $V_{IN} = 3.6\text{ V}$ ,  $V_{OUT} = 1.8\text{ V}$ )  
 L = MDT1608CHR47N (1608size\_0.47  $\mu\text{H}$ )  
 MODE = "H" forced PWM control

RP508K181x ( $V_{IN} = 3.6\text{ V}$ ,  $V_{OUT} = 1.8\text{ V}$ )  
 L = MDT1608CHR47N (1608size\_0.47  $\mu\text{H}$ )  
 MODE = "H" forced PWM control

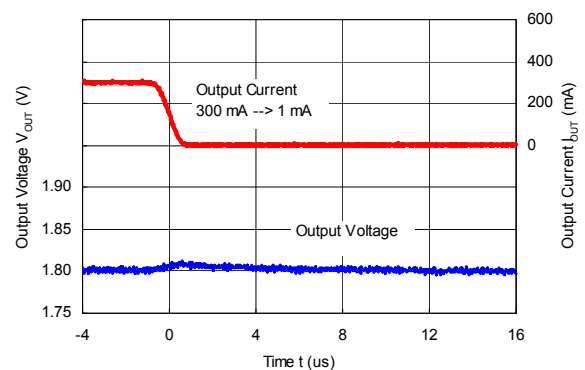
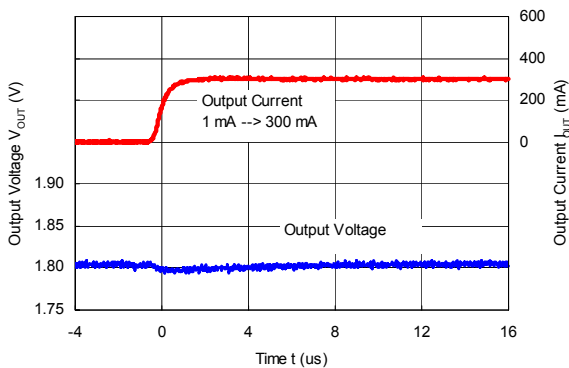

RP508K181x ( $V_{IN} = 3.6\text{ V}$ ,  $V_{OUT} = 1.8\text{ V}$ )  
 L = MDT1608CHR47N (1608size\_0.47  $\mu\text{H}$ )  
 MODE = "H" forced PWM control

RP508K181x ( $V_{IN} = 3.6\text{ V}$ ,  $V_{OUT} = 1.8\text{ V}$ )  
 L = MDT1608CHR47N (1608size\_0.47  $\mu\text{H}$ )  
 MODE = "H" forced PWM control

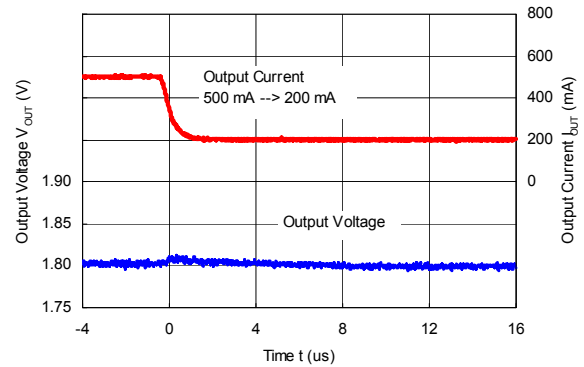
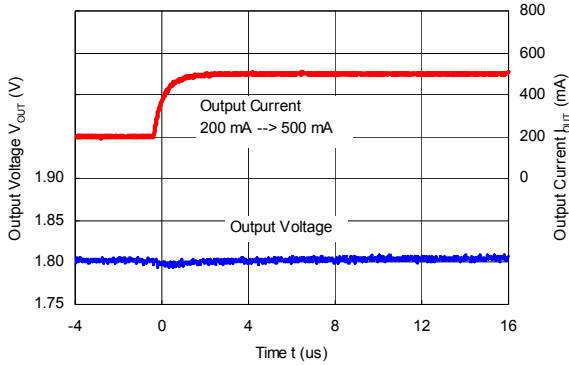

RP508K331x ( $V_{IN} = 5.0\text{ V}$ ,  $V_{OUT} = 3.3\text{ V}$ )  
 L = MDT1608CH1R0N (1608size\_1.0  $\mu\text{H}$ )  
 MODE = "H" forced PWM control

RP508K331x ( $V_{IN} = 5.0\text{ V}$ ,  $V_{OUT} = 3.3\text{ V}$ )  
 L = MDT1608CH1R0N (1608size\_1.0  $\mu\text{H}$ )  
 MODE = "H" forced PWM control

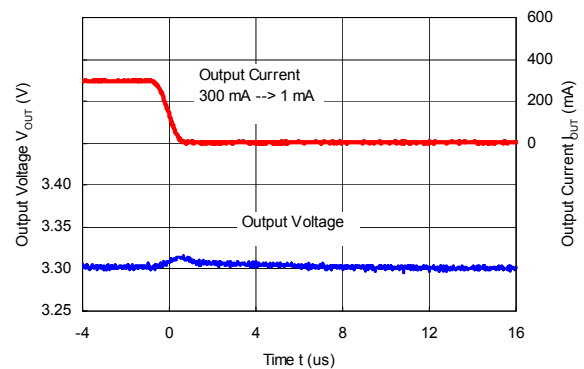
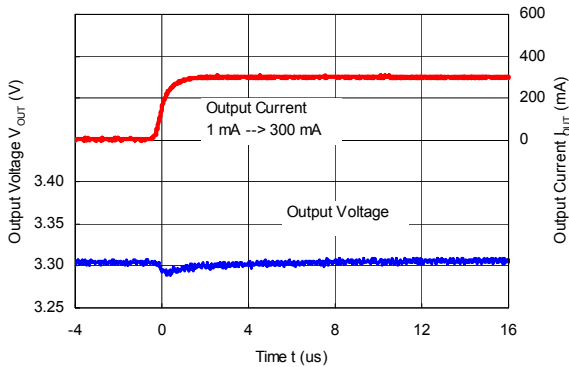

RP508K331x ( $V_{IN} = 5.0\text{ V}$ ,  $V_{OUT} = 3.3\text{ V}$ )  
 L = MDT1608CH1R0N (1608size\_1.0  $\mu\text{H}$ )  
 MODE = "H" forced PWM control

RP508K331x ( $V_{IN} = 5.0\text{ V}$ ,  $V_{OUT} = 3.3\text{ V}$ )  
 L = MDT1608CH1R0N (1608size\_1.0  $\mu\text{H}$ )  
 MODE = "H" forced PWM control

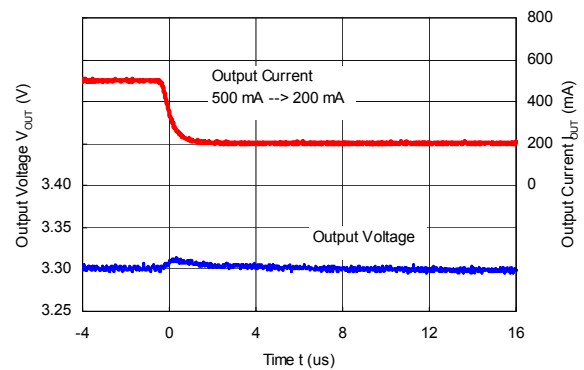
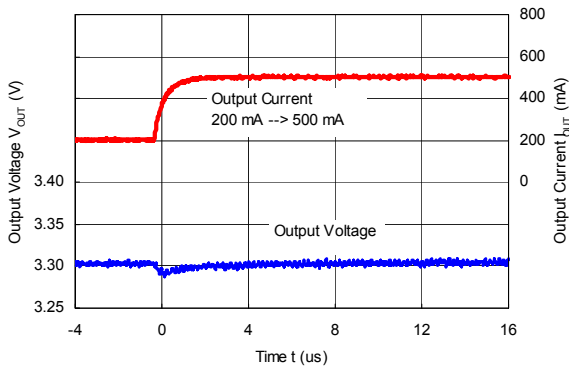

**Load Transient Response ( $C_{OUT} = 4.7\mu F, C1005X5R0J475M$ )**

RP508K081x ( $V_{IN} = 3.6 V, V_{OUT} = 0.8 V$ )  
 L = MDT1608CHR47N (1608size\_0.47  $\mu H$ )  
 MODE = "L" PWM/VFM auto switching control

RP508K081x ( $V_{IN} = 3.6V, V_{OUT} = 0.8 V$ )  
 L = MDT1608CHR47N (1608size\_0.47  $\mu H$ )  
 MODE = "L" PWM/VFM auto switching control

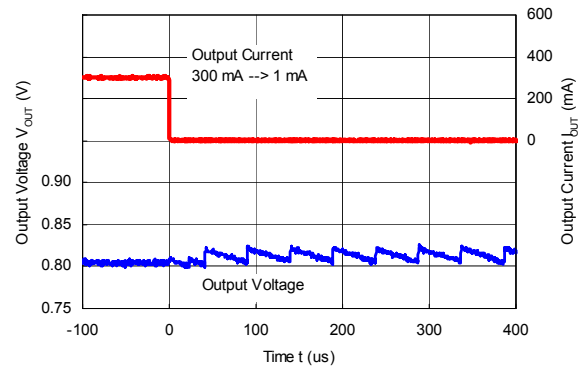
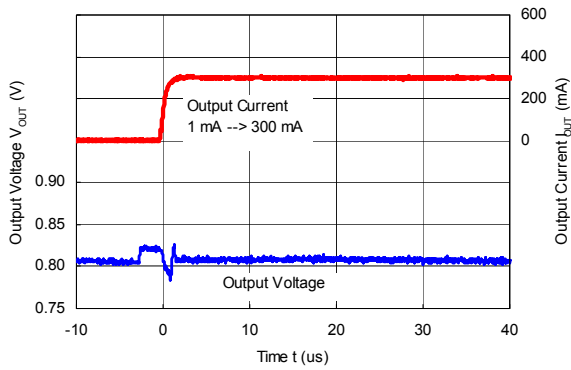

RP508K121x ( $V_{IN} = 3.6 V, V_{OUT} = 1.2 V$ )  
 L = MDT1608CHR47N (1608size\_0.47  $\mu H$ )  
 MODE = "L" PWM/VFM auto switching control

RP508K121x ( $V_{IN} = 3.6 V, V_{OUT} = 1.2 V$ )  
 L = MDT1608CHR47N (1608size\_0.47  $\mu H$ )  
 MODE = "L" PWM/VFM auto switching control

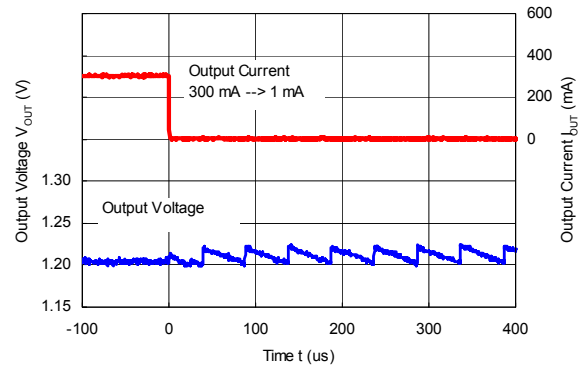
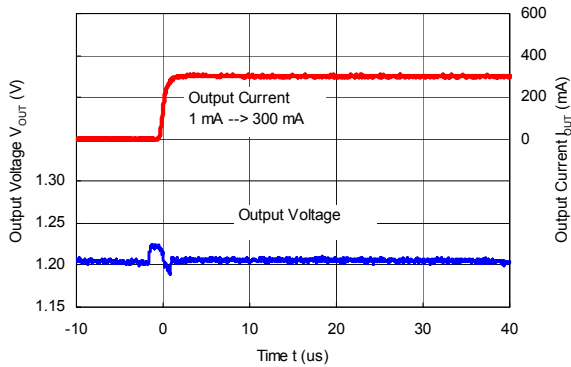

RP508K181x ( $V_{IN} = 3.6 V, V_{OUT} = 1.8 V$ )  
 L = MDT1608CHR47N (1608size\_0.47  $\mu H$ )  
 MODE = "L" PWM/VFM auto switching control

RP508K181x ( $V_{IN} = 3.6 V, V_{OUT} = 1.8 V$ )  
 L = MDT1608CHR47N (1608size\_0.47  $\mu H$ )  
 MODE = "L" PWM/VFM auto switching control

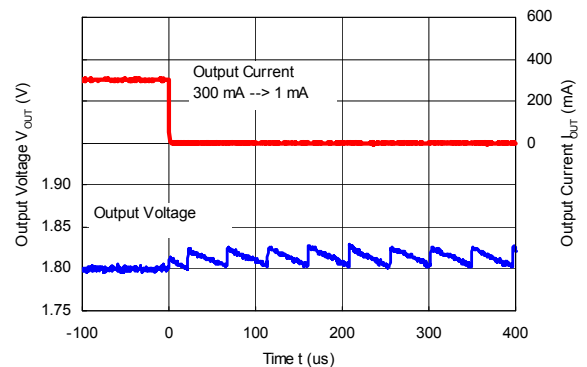
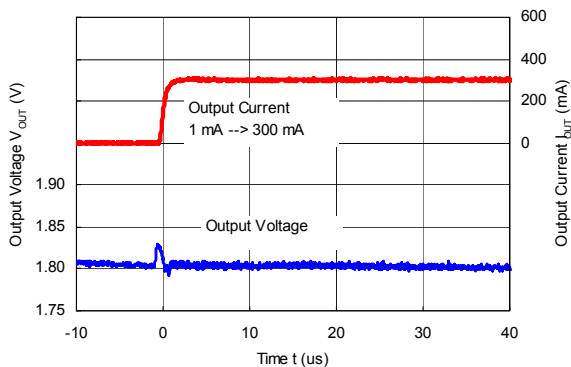

RP508K331x ( $V_{IN} = 5.0\text{ V}$ ,  $V_{OUT} = 3.3\text{ V}$ )  
 L = MDT1608CH1R0N (1608size\_1.0  $\mu\text{H}$ )  
 MODE = "L" PWM/VFM auto switching control

RP508K331x ( $V_{IN} = 5.0\text{ V}$ ,  $V_{OUT} = 3.3\text{ V}$ )  
 L = MDT1608CH1R0N (1608size\_1.0  $\mu\text{H}$ )  
 MODE = "L" PWM/VFM auto switching control

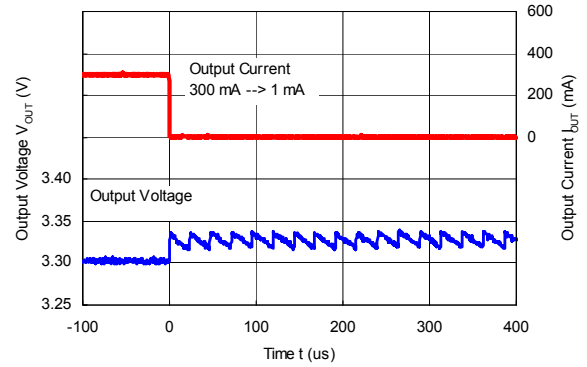
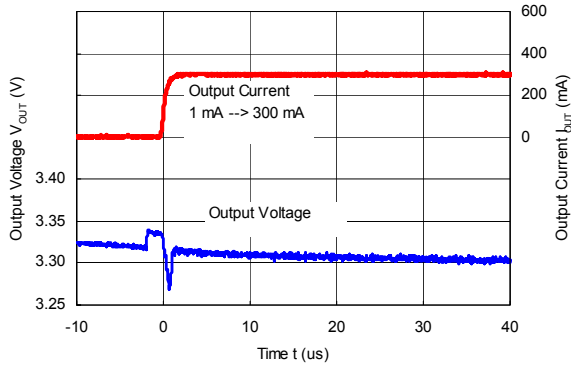

**19) Mode Switching Waveform**

RP508K121x ( $V_{IN} = 3.6\text{ V}$ ,  $V_{OUT} = 1.2\text{ V}$ ,  $I_{OUT} = 1\text{ mA}$ )  
 MODE = "L" → MODE = "H"

RP508K121x ( $V_{IN} = 3.6\text{ V}$ ,  $V_{OUT} = 1.2\text{ V}$ ,  $I_{OUT} = 1\text{ mA}$ )  
 MODE = "H" → MODE = "L"

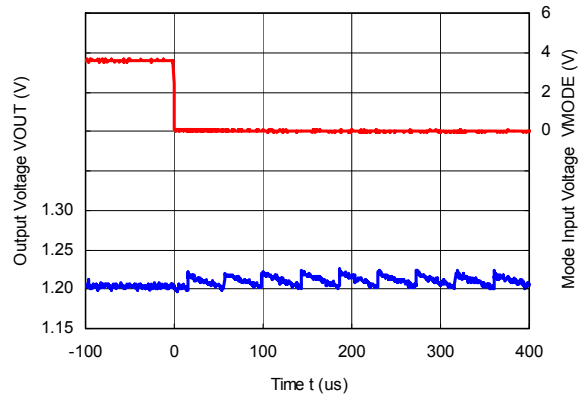
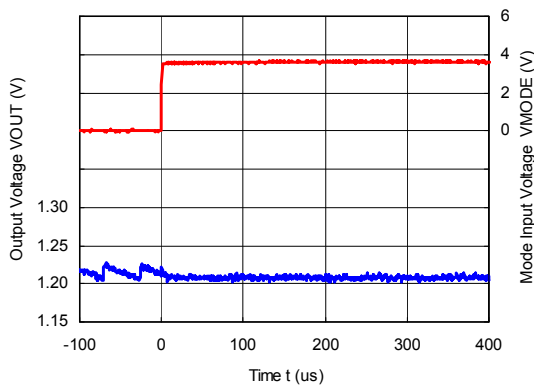

RP508K181x ( $V_{IN} = 3.6\text{ V}$ ,  $V_{OUT} = 1.8\text{ V}$ ,  $I_{OUT} = 1\text{ mA}$ )  
 MODE = "L" → MODE = "H"

RP508K181x ( $V_{IN} = 3.6\text{ V}$ ,  $V_{OUT} = 1.8\text{ V}$ ,  $I_{OUT} = 1\text{ mA}$ )  
 MODE = "H" → MODE = "L"

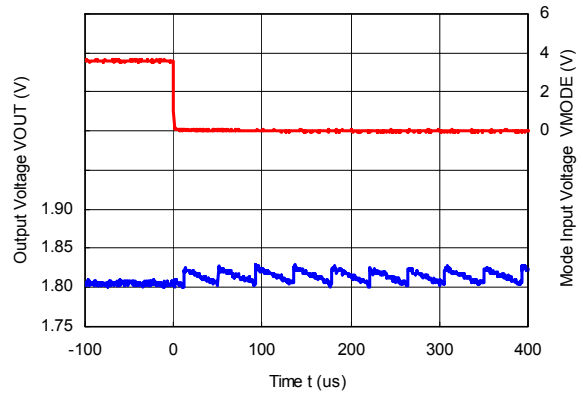
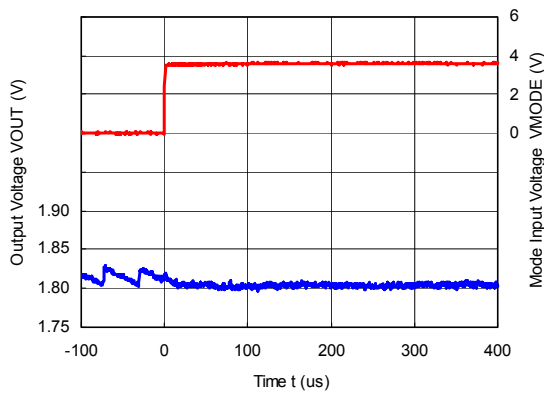



1. The products and the product specifications described in this document are subject to change or discontinuation of production without notice for reasons such as improvement. Therefore, before deciding to use the products, please refer to Ricoh sales representatives for the latest information thereon.
2. The materials in this document may not be copied or otherwise reproduced in whole or in part without prior written consent of Ricoh.
3. Please be sure to take any necessary formalities under relevant laws or regulations before exporting or otherwise taking out of your country the products or the technical information described herein.
4. The technical information described in this document shows typical characteristics of and example application circuits for the products. The release of such information is not to be construed as a warranty of or a grant of license under Ricoh's or any third party's intellectual property rights or any other rights.
5. The products listed in this document are intended and designed for use as general electronic components in standard applications (office equipment, telecommunication equipment, measuring instruments, consumer electronic products, amusement equipment etc.). Those customers intending to use a product in an application requiring extreme quality and reliability, for example, in a highly specific application where the failure or misoperation of the product could result in human injury or death (aircraft, spacevehicle, nuclear reactor control system, traffic control system, automotive and transportation equipment, combustion equipment, safety devices, life support system etc.) should first contact us.
6. We are making our continuous effort to improve the quality and reliability of our products, but semiconductor products are likely to fail with certain probability. In order to prevent any injury to persons or damages to property resulting from such failure, customers should be careful enough to incorporate safety measures in their design, such as redundancy feature, fire containment feature and fail-safe feature. We do not assume any liability or responsibility for any loss or damage arising from misuse or inappropriate use of the products.
7. Anti-radiation design is not implemented in the products described in this document.
8. Please contact Ricoh sales representatives should you have any questions or comments concerning the products or the technical information.



**Ricoh is committed to reducing the environmental loading materials in electrical devices with a view to contributing to the protection of human health and the environment.**

Ricoh has been providing RoHS compliant products since April 1, 2006 and Halogen-free products since April 1, 2012.

**RICOH** RICOH ELECTRONIC DEVICES CO., LTD.

<http://www.e-devices.ricoh.co.jp/en/>

#### Sales & Support Offices

##### **RICOH ELECTRONIC DEVICES CO., LTD.**

**Higashi-Shinagawa Office (International Sales)**  
3-32-3, Higashi-Shinagawa, Shinagawa-ku, Tokyo 140-8655, Japan  
Phone: +81-3-5479-2857 Fax: +81-3-5479-0502

##### **RICOH EUROPE (NETHERLANDS) B.V.**

**Semiconductor Support Centre**  
Prof. W.H. Keesomlaan 1, 1183 DJ Amstelveen, The Netherlands  
Phone: +31-20-5474-309

##### **RICOH INTERNATIONAL B.V. - German Branch**

**Semiconductor Sales and Support Centre**  
Oberrather Strasse 6, 40472 Düsseldorf, Germany  
Phone: +49-211-6546-0

##### **RICOH ELECTRONIC DEVICES KOREA CO., LTD.**

3F, Haesung Bldg, 504, Teheran-ro, Gangnam-gu, Seoul, 135-725, Korea  
Phone: +82-2-2135-5700 Fax: +82-2-2051-5713

##### **RICOH ELECTRONIC DEVICES SHANGHAI CO., LTD.**

Room 403, No.2 Building, No.690 Bibo Road, Pu Dong New District, Shanghai 201203, People's Republic of China  
Phone: +86-21-5027-3200 Fax: +86-21-5027-3299

##### **RICOH ELECTRONIC DEVICES CO., LTD.**

**Taipei office**  
Room 109, 10F-1, No.51, Hengyang Rd., Taipei City, Taiwan (R.O.C.)  
Phone: +886-2-2313-1621/1622 Fax: +886-2-2313-1623

# Mouser Electronics

Authorized Distributor

Click to View Pricing, Inventory, Delivery & Lifecycle Information:

[Ricoch Electronics:](#)

[RP508K241A-TR](#) [RP508K301B-TR](#) [RP508K281B-TR](#) [RP508K131B5-TR](#) [RP508K281A-TR](#) [RP508K321B-TR](#)



Компания «Океан Электроники» предлагает заключение долгосрочных отношений при поставках импортных электронных компонентов на взаимовыгодных условиях!

Наши преимущества:

- Поставка оригинальных импортных электронных компонентов напрямую с производств Америки, Европы и Азии, а так же с крупнейших складов мира;
- Широкая линейка поставок активных и пассивных импортных электронных компонентов (более 30 млн. наименований);
- Поставка сложных, дефицитных, либо снятых с производства позиций;
- Оперативные сроки поставки под заказ (от 5 рабочих дней);
- Экспресс доставка в любую точку России;
- Помощь Конструкторского Отдела и консультации квалифицированных инженеров;
- Техническая поддержка проекта, помощь в подборе аналогов, поставка прототипов;
- Поставка электронных компонентов под контролем ВП;
- Система менеджмента качества сертифицирована по Международному стандарту ISO 9001;
- При необходимости вся продукция военного и аэрокосмического назначения проходит испытания и сертификацию в лаборатории (по согласованию с заказчиком);
- Поставка специализированных компонентов военного и аэрокосмического уровня качества (Xilinx, Altera, Analog Devices, Intersil, Interpoint, Microsemi, Actel, Aeroflex, Peregrine, VPT, Syfer, Eurofarad, Texas Instruments, MS Kennedy, Miteq, Cobham, E2V, MA-COM, Hittite, Mini-Circuits, General Dynamics и др.);

Компания «Океан Электроники» является официальным дистрибьютором и эксклюзивным представителем в России одного из крупнейших производителей разъемов военного и аэрокосмического назначения «JONHON», а так же официальным дистрибьютором и эксклюзивным представителем в России производителя высокотехнологичных и надежных решений для передачи СВЧ сигналов «FORSTAR».



## JONHON

«JONHON» (основан в 1970 г.)

Разъемы специального, военного и аэрокосмического назначения:

(Применяются в военной, авиационной, аэрокосмической, морской, железнодорожной, горно- и нефтедобывающей отраслях промышленности)

«FORSTAR» (основан в 1998 г.)

ВЧ соединители, коаксиальные кабели, кабельные сборки и микроволновые компоненты:

(Применяются в телекоммуникациях гражданского и специального назначения, в средствах связи, РЛС, а так же военной, авиационной и аэрокосмической отраслях промышленности).



Телефон: 8 (812) 309-75-97 (многоканальный)

Факс: 8 (812) 320-03-32

Электронная почта: [ocean@oceanchips.ru](mailto:ocean@oceanchips.ru)

Web: <http://oceanchips.ru/>

Адрес: 198099, г. Санкт-Петербург, ул. Калинина, д. 2, корп. 4, лит. А