

EVALUATION KIT MANUAL
FOLLOWS DATA SHEET

MAXIM

Adjustable, High-Linearity, SiGe Dual-Band LNA/Mixer ICs

General Description

The MAX2320/MAX2321/MAX2322/MAX2324/MAX2326/MAX2327 high-performance silicon germanium (SiGe) receiver front-end ICs set a new industry standard for low noise and high linearity at a low supply current. This family integrates a variety of unique features such as an LO frequency doubler and divider, dual low-noise amplifier (LNA) gain settings, and a low-current paging mode that extends the handset standby time.

The MAX2320 family includes six ICs: four operate at both cellular and PCS frequencies, one operates at cellular frequencies, and one at PCS frequencies (see *Selector Guide*). Each part includes an LNA with a high input third-order intercept point (IIP3) to minimize inter-modulation and cross-modulation in the presence of large interfering signals. In low-gain mode, the LNA is bypassed to provide higher cascaded IIP3 at a lower current. For paging, a low-current, high-gain mode is provided.

The CDMA mixers in cellular and PCS bands have high linearity, low noise, and differential IF outputs. The FM mixer is designed for lower current and a single-ended output.

All devices come in a 20-pin TSSOP-EP package with exposed paddle (EP) and are specified for the extended temperature range (-40°C to +85°C).

Applications

CDMA/TDMA/PDC/WCDMA/GSM Cellular Phones
Single/Dual/Triple-Mode Phones
Wireless Local Loop (WLL)

Selector Guide

| PART | DESCRIPTION |
|---------|---|
| MAX2320 | Dual-band, dual VCO inputs, and dual IF outputs |
| MAX2321 | MAX2320 with LO doubler |
| MAX2322 | PCS band, single mode with optional frequency doubler |
| MAX2324 | Cellular band, dual IF outputs |
| MAX2326 | MAX2320 with LO divider |
| MAX2327 | Dual-band, dual VCO inputs, and separately controlled VCO buffers |

Typical Application Circuits appear at end of data sheet.

MAXIM

Features

- ◆ Ultra-High Linearity at Ultra-Low Current and Noise
- ◆ +2.7V to +3.6V Operation
- ◆ Pin-Selectable Low-Gain Mode Reduces Gain by 17dB and Current by 3mA
- ◆ Pin-Selectable Paging Mode Reduces Current Draw by 6mA when Transmitter Is Not in Use
- ◆ LO Output Buffers
- ◆ LO Frequency Doubler (MAX2321)
- ◆ LO Frequency Divider (MAX2326)
- ◆ 0.1µA Shutdown Current
- ◆ 20-Pin TSSOP-EP Package

Ordering Information

| PART | TEMP. RANGE | PIN-PACKAGE |
|------------|----------------|-------------|
| MAX2320EUP | -40°C to +85°C | 20 TSSOP-EP |
| MAX2321EUP | -40°C to +85°C | 20 TSSOP-EP |
| MAX2322EUP | -40°C to +85°C | 20 TSSOP-EP |
| MAX2324EUP | -40°C to +85°C | 20 TSSOP-EP |
| MAX2326EUP | -40°C to +85°C | 20 TSSOP-EP |
| MAX2327EUP | -40°C to +85°C | 20 TSSOP-EP |

Pin Configurations

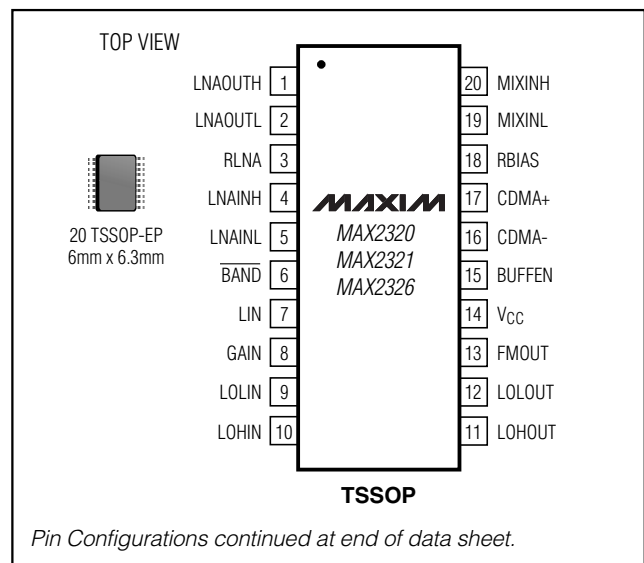

MAX2320/21/22/24/26/27

Adjustable, High-Linearity, SiGe Dual-Band LNA/Mixer ICs

ABSOLUTE MAXIMUM RATINGS

V_{CC} to GND-0.3V to +4.3V
 Digital Input Voltage to GND-0.3V to (V_{CC} + 0.3V)
 RF Input Signals1.0V peak
 Continuous Power Dissipation (T_A = +70°C)
 20-Pin TSSOP-EP (derate 80mW/°C above +70°C).....6.4W
 Operating Temperature Range-40°C to +85°C

Junction Temperature+150°C
 Storage Temperature Range-65°C to +150°C
 Lead Temperature (soldering, 10s)+300°C

Stresses beyond those listed under "Absolute Maximum Ratings" may cause permanent damage to the device. These are stress ratings only, and functional operation of the device at these or any other conditions beyond those indicated in the operational sections of the specifications is not implied. Exposure to absolute maximum rating conditions for extended periods may affect device reliability.

DC ELECTRICAL CHARACTERISTICS—MAX2320/MAX2321/MAX2326

(V_{CC} = +2.7V to +3.6V, R_{RBIAS} = R_{RLNA} = 20kΩ, no RF signals applied, BUFFEN = low, LO buffer outputs connected to V_{CC} through 50Ω resistors, all other RF and IF outputs connected to V_{CC}, T_A = -40°C to +85°C, unless otherwise noted. Typical values are at V_{CC} = +2.75V and T_A = +25°C, unless otherwise noted.)

| PARAMETER | SYMBOL | CONDITIONS | | MIN | TYP | MAX | UNITS |
|-----------------------------------|--------------------|---------------------------------------|---------------|----------------------------|------|------|-------|
| Supply Voltage | V _{CC} | | | +2.7 | | +3.6 | V |
| Operating Supply Current (Note 1) | I _{CC} | High-gain, high-linearity modes | PCS band | MAX2320/6 | 20 | 25.3 | mA |
| | | | | MAX2321 | 24 | 30.8 | |
| | | | Cellular band | MAX2320/1 | 20 | 25.3 | |
| | | | | MAX2326 | 21 | 25.5 | |
| | | High-gain, low-linearity paging modes | PCS band | MAX2320/6 | 15 | 19.5 | |
| | | | | MAX2321 | 19 | 25 | |
| | | | Cellular band | MAX2320/1 | 15 | 19.5 | |
| | | | | MAX2326 | 15.5 | 20 | |
| | | Low-gain, high-linearity modes | PCS band | MAX2320/6 | 17 | 21.5 | |
| | | | | MAX2321 | 21 | 26 | |
| | | | Cellular band | MAX2320/1 | 17 | 21.5 | |
| | | | | MAX2326 | 17.5 | 21.5 | |
| FM mode | | | 14 | 18.5 | | | |
| LO Buffer Supply Current | I _{LOBUF} | Additional current for BUFFEN = high | | Cellular band MAX2320/1 | 5 | 7.5 | mA |
| | | | | Cellular band MAX2326 | 5.5 | 8.5 | |
| | | | | PCS band MAX2320/1/6 | 5 | 7.5 | |
| Shutdown Supply Current | I _{SHDN} | (Note 1) | | | 0.1 | 20 | μA |
| Digital Input Logic High | V _{IH} | | | 2.0 | | | V |
| Digital Input Logic Low | V _{IL} | | | | | 0.6 | V |
| Digital Input Current High | I _{IH} | | | | | 5 | μA |
| Digital Input Current Low | I _{IL} | | | -35 | | | μA |

Adjustable, High-Linearity, SiGe Dual-Band LNA/Mixer ICs

MAX2320/21/22/24/26/27

DC ELECTRICAL CHARACTERISTICS—MAX2322/MAX2324

($V_{CC} = +2.7V$ to $+3.6V$, $R_{RBIAS} = R_{RLNA} = 20k\Omega$, no RF signals applied, $BUFFEN = low$, LO buffer outputs connected to V_{CC} through 50Ω resistors, all other RF and IF outputs connected to V_{CC} , $T_A = -40^\circ C$ to $+85^\circ C$, unless otherwise noted. Typical values are at $V_{CC} = +2.75V$ and $T_A = +25^\circ C$, unless otherwise noted.)

| PARAMETER | SYMBOL | CONDITIONS | | MIN | TYP | MAX | UNITS |
|--------------------------------------|-------------|--|---|-----------------------|------------|------|---------|
| Supply Voltage | V_{CC} | | | +2.7 | | +3.6 | V |
| Operating Supply Current (Note 1) | I_{CC} | High-gain, high-linearity modes | PCS band (MAX2322) | LOX2 = low | 20 | 25.3 | mA |
| | | | | LOX2 = high | 24 | 30.8 | |
| | | | Cellular band (MAX2324) | | 20 | 25.3 | |
| | | | High-gain, low-linearity paging modes | PCS band (MAX2322) | LOX2 = low | 15 | |
| | | LOX2 = high | | | 19 | 25 | |
| | | Cellular band (MAX2324) | | 15 | 19.5 | | |
| | | Low-gain, high-linearity modes | | PCS band (MAX2322) | LOX2 = low | 17 | |
| | | | LOX2 = high | | 21 | 26 | |
| Cellular band (MAX2324) | | | 17 | 21.5 | | | |
| FM mode (MAX2324 only) | | | 14.5 | 18.5 | | | |
| LO Buffer Supply Current | I_{LOBUF} | Additional current for $BUFFEN = high$ | | | 5 | 7.5 | mA |
| Shutdown Supply Current | I_{SHDN} | (Note 1) | | | 0.1 | 20 | μA |
| Digital Input Logic High | V_{IH} | | | 2.0 | | | V |
| Digital Input Logic Low | V_{IL} | | | | | 0.6 | V |
| Digital Input Current High | I_{IH} | | | | | 5 | μA |
| Digital Input Current Low | I_{IL} | | | -35 | | | μA |
| Digital Output Logic High | V_{OH} | MAX2324 only | | 1.7 | | | V |
| Digital Output Logic Low | V_{OL} | MAX2324 only | | | | 0.4 | V |
| Digital Output Current High | I_{OH} | MAX2324 only | | 30 | | | μA |
| Digital Output Current Low | I_{OL} | MAX2324 only, $V_{MODEOUT} = 2.4V$ | | | | -100 | μA |

DC ELECTRICAL CHARACTERISTICS—MAX2327

($V_{CC} = +2.7V$ to $+3.6V$, $R_{RBIAS} = R_{RLNA} = 20k\Omega$, no RF signals applied, $BUFFEN = low$, LO buffer outputs connected to V_{CC} through 50Ω resistors, all other RF and IF outputs connected to V_{CC} , $T_A = -40^\circ C$ to $+85^\circ C$, unless otherwise noted. Typical values are at $V_{CC} = +2.75V$ and $T_A = +25^\circ C$, unless otherwise noted.)

| PARAMETER | SYMBOL | CONDITIONS | | MIN | TYP | MAX | UNITS |
|--------------------------------------|-------------|--|---------------|------|------|------|---------|
| Supply Voltage | V_{CC} | | | +2.7 | | +3.6 | V |
| Operating Supply Current (Note 1) | I_{CC} | High-gain mode | PCS band | | 15 | 19.5 | mA |
| | | | Cellular band | | 15 | 19.5 | |
| | | FM mode | | | 14.5 | 18.5 | |
| LO Buffer Supply Current | I_{LOBUF} | Additional current for $BUFFEN = high$ | | | 5 | 7.5 | mA |
| Shutdown Supply Current | I_{SHDN} | (Note 1) | | | 0.1 | 20 | μA |
| Digital Input Logic High | V_{IH} | | | 2.0 | | | V |
| Digital Input Logic Low | V_{IL} | | | | | 0.6 | V |
| Digital Input Current High | I_{IH} | | | | | 5 | μA |
| Digital Input Current Low | I_{IL} | | | -35 | | | μA |

Adjustable, High-Linearity, SiGe Dual-Band LNA/Mixer ICs

AC ELECTRICAL CHARACTERISTICS—MAX2320/MAX2321/MAX2326

(MAX2322_EV kit, $V_{CC} = +2.75V$, $f_{LNAINH} = f_{MIXINH} = 1960MHz$, $f_{LNAINL} = f_{MIXINL} = 881MHz$, $f_{LOLIN} = 1091MHz$ (digital mode), $f_{LOLIN} = 991MHz$ (FM mode), $f_{LOHIN} = 1750MHz$ (MAX2320, MAX2322 with LOX2 = low, MAX2326 with BAND = low, MAX2327), $f_{LLOHIN} = 1085MHz$ (MAX2321 with BAND = low, MAX2322 with LOX2 = high), $f_{LOHIN} = 1091MHz$ (MAX2321 with BAND = high), $f_{LOHIN} = 2182MHz$ (MAX2326 with BAND = high), LO input power = $-7dBm$ (MAX2320/MAX2326), 50Ω system, $T_A = +25^\circ C$, unless otherwise noted.) (Note 2)

| PARAMETER | SYMBOL | CONDITIONS | MIN | -3 σ | TYP | +3 σ | MAX | UNITS |
|---|---------------|--------------------------------------|----------|-------------|------|-------------|------|-------|
| Low-Band RF Frequency Range (Note 3) | | | 800 | | | | 1000 | MHz |
| High-Band RF Frequency Range (Note 3) | | | 1800 | | | | 2500 | MHz |
| Low-Band LO Frequency Range (Note 3) | | | 700 | | | | 1150 | MHz |
| High-Band LO Frequency Range (Note 3) | | | 1600 | | | | 2300 | MHz |
| IF Frequency Range (Note 3) | | | 50 | | | | 400 | MHz |
| LNA PERFORMANCE | | | | | | | | |
| HIGH-GAIN, HIGH-LINEARITY MODES (Note 1) | | | | | | | | |
| Gain (Note 4) | G | $T_A = +25^\circ C$ | PCS | 13 | 14.5 | 16 | | dB |
| | | | Cellular | 14 | 15 | 16 | | |
| | | $T_A = -40^\circ C$ to $+85^\circ C$ | PCS | 11.5 | 14.5 | 17 | | |
| | | | Cellular | 13 | 15 | 16.5 | | |
| Gain Variation Over Temperature Relative to $+25^\circ C$ | | $T_A = -40^\circ C$ to $+85^\circ C$ | PCS | ± 0.5 | | | | dB |
| | | | Cellular | ± 0.5 | | | | |
| Noise Figure (Note 5) | NF | | PCS | | 1.8 | 2 | 2.1 | dB |
| | | | Cellular | | 1.3 | 1.4 | 1.5 | |
| Input Third-Order Intercept (Notes 5, 6) | IIP3 | $T_A = T_{MIN}$ to T_{MAX} | PCS | 7 | +8 | | | dBm |
| | | | Cellular | 6 | +8 | | | |
| Input 1dB Compression | P_{OUT} 1dB | $T_A = T_{MIN}$ to T_{MAX} | PCS | -11 | -10 | | | dBm |
| | | | Cellular | -11 | -10 | | | |
| HIGH-GAIN, LOW-LINEARITY PAGING MODES AND FM MODE (Note 1) | | | | | | | | |
| Gain (Note 4) | G | | PCS | 13.5 | | | | dB |
| | | | Cellular | 14.5 | | | | |
| Gain Variation Over Temperature Relative to $+25^\circ C$ | | $T_A = -40^\circ C$ to $+85^\circ C$ | PCS | ± 0.5 | | | | dB |
| | | | Cellular | ± 0.5 | | | | |
| Noise Figure (Note 5) | | | PCS | | 1.9 | 2.1 | 2.2 | dB |
| | | | Cellular | | 1.4 | 1.5 | 1.6 | |

Adjustable, High-Linearity, SiGe Dual-Band LNA/Mixer ICs

MAX2320/21/22/24/26/27

AC ELECTRICAL CHARACTERISTICS (continued)

(MAX2322_EV kit, $V_{CC} = +2.75V$, $f_{LNAINH} = f_{MIXINH} = 1960MHz$, $f_{LNAINL} = f_{MIXINL} = 881MHz$, $f_{LOLIN} = 1091MHz$ (digital mode), $f_{LOLIN} = 991MHz$ (FM mode), $f_{LOHIN} = 1750MHz$ (MAX2320, MAX2322 with LOX2 = low, MAX2326 with BAND = low, MAX2327), $f_{LLOHIN} = 1085MHz$ (MAX2321 with BAND = low, MAX2322 with LOX2 = high), $f_{LOHIN} = 1091MHz$ (MAX2321 with BAND = high), $f_{LOHIN} = 2182MHz$ (MAX2326 with BAND = high), LO input power = $-7dBm$ (MAX2320/MAX2326), 50Ω system, $T_A = +25^\circ C$, unless otherwise noted.) (Note 2)

| PARAMETER | SYMBOL | CONDITIONS | | MIN | -3 σ | TYP | +3 σ | MAX | UNITS |
|--|--------|--|------------------------------|------|-------------|---------|-------------|------|-------|
| Input Third-Order Intercept (Notes 5, 6) | | PCS | | | | +6.5 | | | dBm |
| | | Cellular | | | | +6 | | | |
| LOW-GAIN, HIGH-LINEARITY MODES (Note 1) | | | | | | | | | |
| Gain (Note 4) | G | PCS | | | | -2 | | | dB |
| | | Cellular | | | | -1.5 | | | |
| Gain Variation Over Temperature Relative to $+25^\circ C$ | | $T_A = -40^\circ C$ to $+85^\circ C$ | PCS | | | 0.5 | | | dB |
| | | | Cellular | | | 0.5 | | | |
| Noise Figure (Note 5) | NF | PCS | | | | 5 | 5.5 | 6 | dB |
| | | Cellular | | | | 4 | 4.25 | 4.5 | |
| Input Third-Order Intercept (Notes 5, 6) | IIP3 | PCS | | | +10.5 | +11.5 | +12.5 | | dBm |
| | | Cellular | | | +11.5 | +12.5 | +13.5 | | |
| MIXER PERFORMANCE | | | | | | | | | |
| HIGH-GAIN, HIGH-LINEARITY, AND LOW-GAIN MODES (Note 1) | | | | | | | | | |
| Gain (Note 4) | G | $T_A = +25^\circ C$, PCS | Without doubler | 11 | 11.8 | 12.5 | 13.2 | 14 | dB |
| | | | With doubler | 10.5 | 11.1 | 12 | 12.9 | 13.5 | |
| | | $T_A = -40^\circ C$ to $+85^\circ C$, PCS | Without doubler | 10 | 10.8 | 12.5 | 14.3 | 15.3 | |
| | | | With doubler | 9.6 | 10.4 | 12 | 13.1 | 14.3 | |
| | | $T_A = +25^\circ C$, cellular | | 12 | 12.7 | 13.4 | 14.0 | 14.7 | |
| $T_A = -40^\circ C$ to $+85^\circ C$, cellular | | 11.3 | 11.9 | 13.4 | 15.5 | 16.5 | | | |
| Gain Variation Over Temperature Relative to $+25^\circ C$ (Note 5) | | $T_A = -40^\circ C$ to $+85^\circ C$ | PCS | | | ± 1 | | | dB |
| | | | Cellular | | | ± 1 | | | |
| Noise Figure | NF | PCS | Without doubler | | | 7.5 | 7.8 | 8 | dB |
| | | | With doubler | | | 11 | 12.3 | 13.5 | |
| | | Cellular | Without divider | | | 7.5 | 8.1 | 8.5 | |
| | | | With divider | | | 7.8 | 8.4 | 8.8 | |
| Input Third-Order Intercept (Notes 5, 6) | IIP3 | PCS, $T_A = T_{MIN}$ to T_{MAX} | Without doubler | 1.8 | 2.4 | +4 | | dBm | |
| | | | With doubler | 1.4 | 2.8 | +4.7 | | | |
| | | Cellular, $T_A = T_{MIN}$ to T_{MAX} | | 1 | 1.8 | 3.2 | | | |
| Input dB Compression | | PCS | $T_A = T_{MIN}$ to T_{MAX} | -11 | -10 | | | dBm | |
| | | Cellular | | -12 | -10.7 | | | | |

Adjustable, High-Linearity, SiGe Dual-Band LNA/Mixer ICs

AC ELECTRICAL CHARACTERISTICS (continued)

(MAX2322_EV kit, $V_{CC} = +2.75V$, $f_{LNAINH} = f_{MIXINH} = 1960MHz$, $f_{LNAINL} = f_{MIXINL} = 881MHz$, $f_{LOLIN} = 1091MHz$ (digital mode), $f_{LOLIN} = 991MHz$ (FM mode), $f_{LOHIN} = 1750MHz$ (MAX2320, MAX2322 with LOX2 = low, MAX2326 with BAND = low, MAX2327), $f_{LLOHIN} = 1085MHz$ (MAX2321 with BAND = low, MAX2322 with LOX2 = high), $f_{LOHIN} = 1091MHz$ (MAX2321 with BAND = high), $f_{LOHIN} = 2182MHz$ (MAX2326 with BAND = high), LO input power = $-7dBm$ (MAX2320/MAX2326), 50Ω system, $T_A = +25^\circ C$, unless otherwise noted.) (Note 2)

| PARAMETER | SYMBOL | CONDITIONS | MIN | -3 σ | TYP | +3 σ | MAX | UNITS | |
|--|--------|--------------------------------------|-----------------------|-------------|------|-------------|------|---------|----|
| HIGH-GAIN, LOW-LINEARITY, AND LOW-GAIN MODES (Note 1) | | | | | | | | | |
| Gain (Note 4) | G | PCS | Without doubler | 10.6 | 11.3 | 12 | 12.1 | 12.8 | dB |
| | | | With doubler | 10.2 | 10.8 | 11.5 | 12.4 | 13.1 | |
| | | Cellular Band | 11.2 | 12.1 | 13 | 13.8 | 14.7 | | |
| Gain Variation Over Temperature Relative to $+25^\circ C$ | | $T_A = -40^\circ C$ to $+85^\circ C$ | PCS | | | ± 1 | | ± 1 | dB |
| | | | Cellular | | | ± 1 | | ± 1 | |
| Noise Figure | NF | PCS | Without doubler | | | 7.2 | 7.5 | 7.6 | dB |
| | | | With doubler (Note 7) | | | 10.5 | 12 | 13.4 | |
| | | Cellular | Without divider | | | 7 | 7.2 | 7.6 | |
| | | | With divider | | | 7.5 | 7.7 | 8.1 | |
| Input Third-Order Intercept | IIP3 | PCS | Without doubler | | | +1 | | dBm | |
| | | | With doubler | | | +2.2 | | | |
| | | Cellular | | | +1.0 | | | | |
| FM MODE (Note 1) | | | | | | | | | |
| Gain (Note 4) | G | $T_A = +25^\circ C$ | 9.7 | 10.4 | 11.2 | 11.9 | 12.7 | dB | |
| | | $T_A = -40^\circ C$ to $+85^\circ C$ | 7.8 | 9.0 | 11.2 | 14.0 | 15.4 | | |
| Noise Figure | NF | | | | 10.6 | 11.1 | 11.5 | dB | |
| Input Third-Order Intercept (Notes 5, 6) | IIP3 | $T_A = -40^\circ C$ to $+85^\circ C$ | 2.3 | 3.2 | 4.9 | | | dBm | |
| LO BUFFER PERFORMANCE (BUFFEN = HIGH) | | | | | | | | | |
| LO Output Level | | Load = 100Ω pullup resistor | | | -12 | | | dBm | |
| | | BUFFEN = GND | | | -44 | | | | |
| LO_OUT Even Harmonic Distortion | | | | | -31 | | | dBc | |
| LO Emissions at LNA Input Port | | Interstage filter rejection = 20dB | | | -50 | | | dBm | |

Note 1: See Tables 1–5 for operational mode selection.

Note 2: A total of 36 devices from 3 different wafer lots are used to determine the standard deviation. The lots were selected to represent worst-case process conditions.

Note 3: Operation is characterized for the frequencies specified in the conditions; for other frequencies in the band, see Tables 8–12 for LNA and mixer S parameters.

Note 4: Guaranteed by design, characterization, and production functional test.

Note 5: Guaranteed by design and characterization.

Note 6: For cellular band, RF inputs are $-25dBm$ each tone at 881MHz and 882MHz, $f_{LO} = 1091MHz$. For PCS band, RF inputs are $-25dBm$ each tone at 1960MHz and 1961MHz, $f_{LO} = 2170MHz$. For IIP3 vs. I_{CC} trade-off, see *Typical Operating Characteristics*.

Adjustable, High-Linearity, SiGe Dual-Band LNA/Mixer ICs

Typical Operating Characteristics

(MAX232_ EV kit, $V_{CC} = +2.75V$, $f_{LNAINH} = f_{MIXINH} = 1960MHz$, $f_{LNAINL} = f_{MIXINL} = 881MHz$, $f_{LOHIN} = 1750MHz$, $f_{LOLIN} = 1091MHz$ (digital modes), $f_{LOLIN} = 991MHz$ (FM mode), LO input power = -7dBm, 50Ω system, all measurements include matching component losses but not connector and trace losses, $T_A = +25^\circ C$, unless otherwise noted.)

MAX2320/21/22/24/26/27

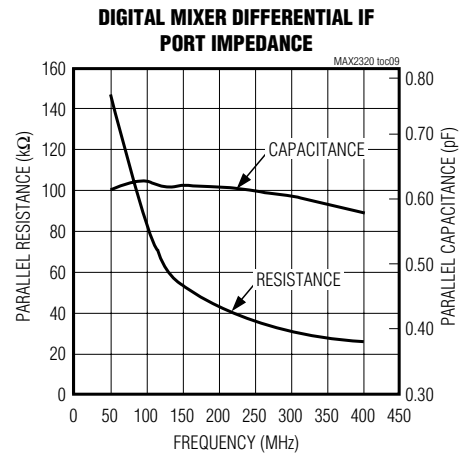
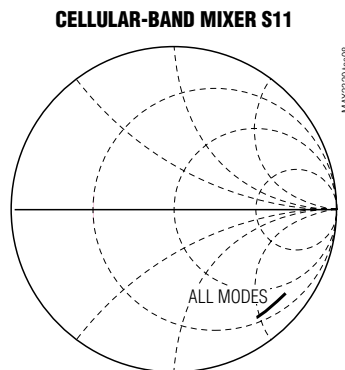
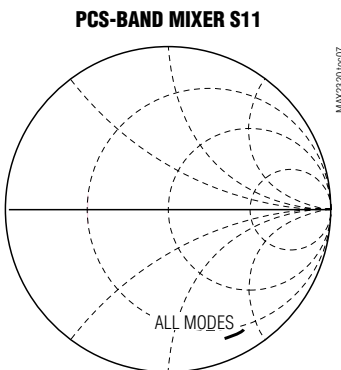
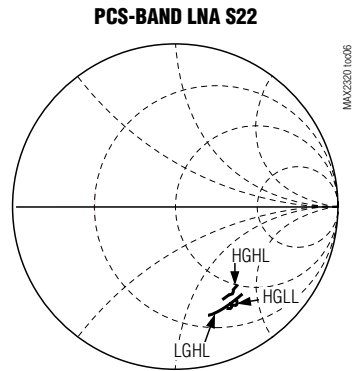
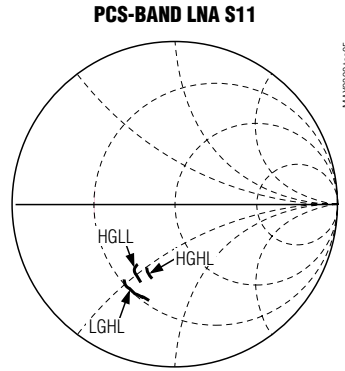
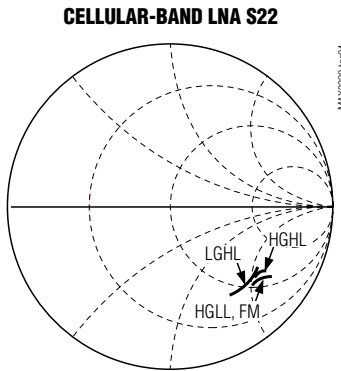
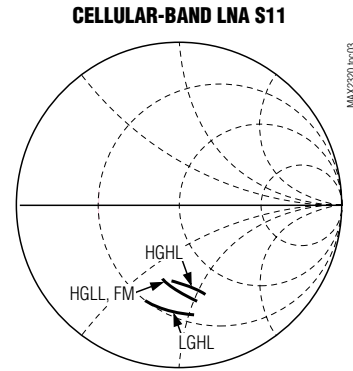
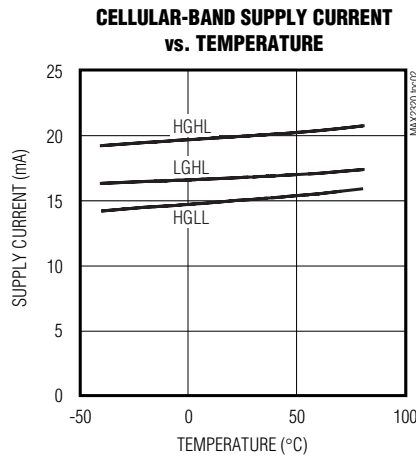
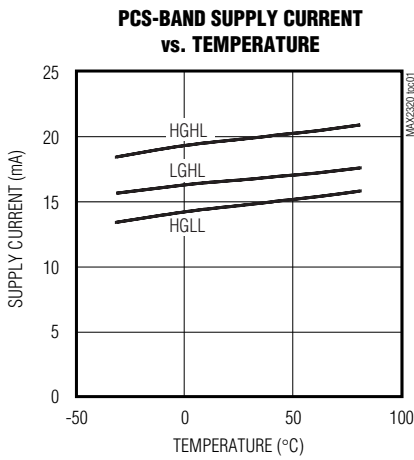

Adjustable, High-Linearity, SiGe Dual-Band LNA/Mixer ICs

Typical Operating Characteristics (continued)

(MAX232_ EV kit, $V_{CC} = +2.75V$, $f_{LNAINH} = f_{MIXINH} = 1960MHz$, $f_{LNAINL} = f_{MIXINL} = 881MHz$, $f_{LOHIN} = 1750MHz$, $f_{LOLIN} = 1091MHz$ (digital modes), $f_{LOLIN} = 991MHz$ (FM mode), LO input power = -7dBm, 50Ω system, all measurements include matching component losses but not connector and trace losses, $T_A = +25^\circ C$, unless otherwise noted.)

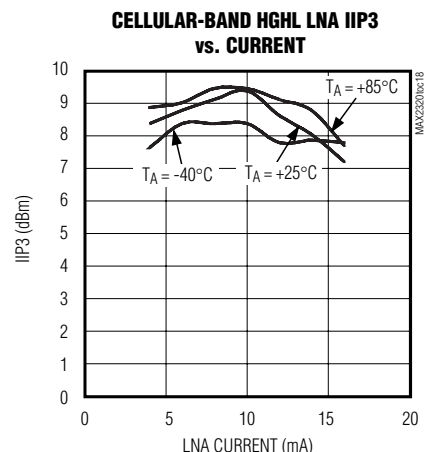
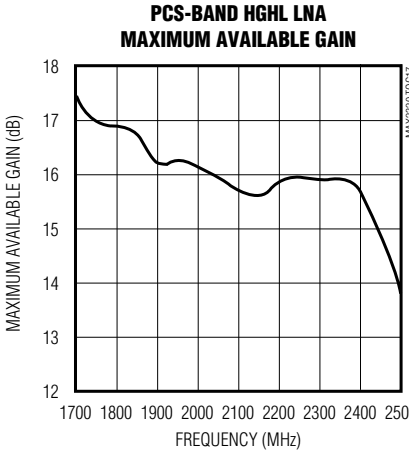
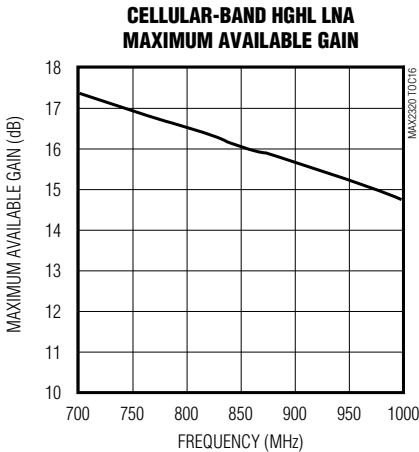
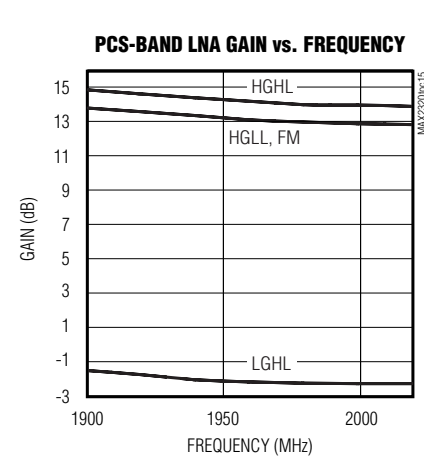
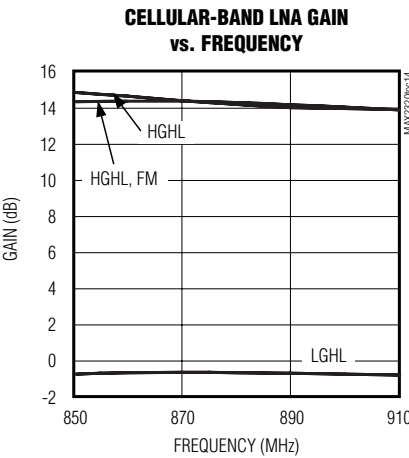
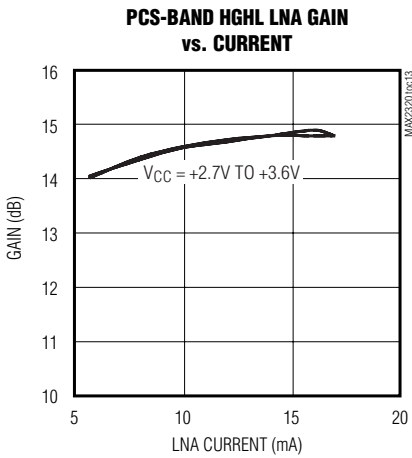
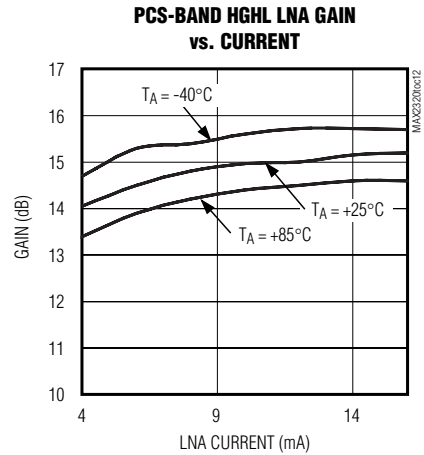
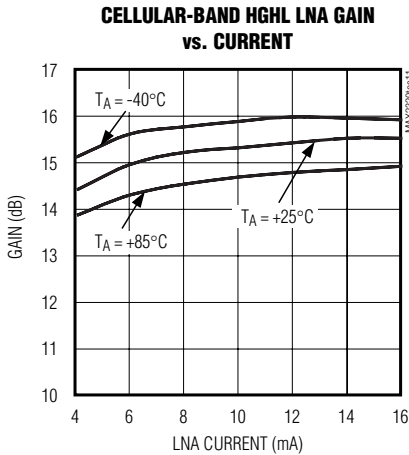
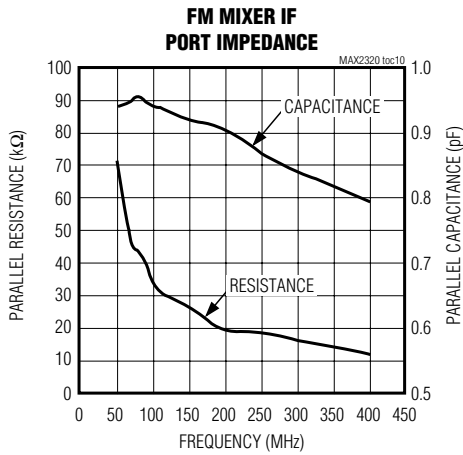

Adjustable, High-Linearity, SiGe Dual-Band LNA/Mixer ICs

Typical Operating Characteristics (continued)

(MAX232_EV kit, $V_{CC} = +2.75V$, $f_{LNAINH} = f_{MIXINH} = 1960MHz$, $f_{LNAINL} = f_{MIXINL} = 881MHz$, $f_{LOINH} = 1750MHz$, $f_{LOINL} = 1091MHz$ (digital modes), $f_{LOLIN} = 991MHz$ (FM mode), LO input power = -7dBm, 50Ω system, all measurements include matching component losses but not connector and trace losses, $T_A = +25^\circ C$, unless otherwise noted.)

MAX2320/21/22/24/26/27

CELLULAR-BAND HGHL LNA IIP3 vs. CURRENT

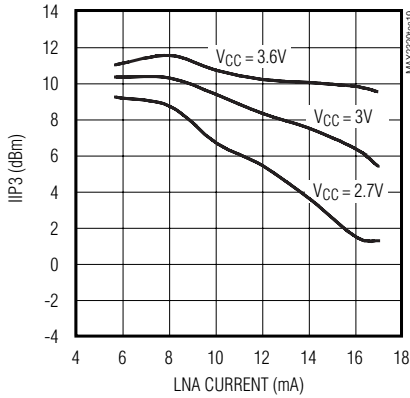

PCS-BAND HGHL LNA IIP3 vs. CURRENT

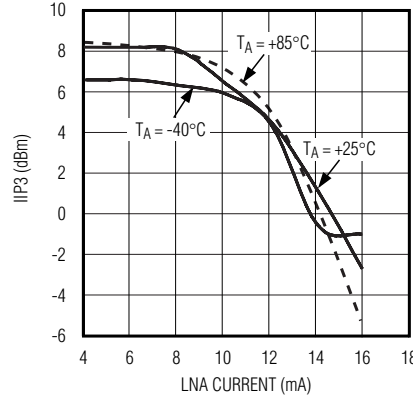

PCS-BAND HGHL LNA IIP3 vs. CURRENT

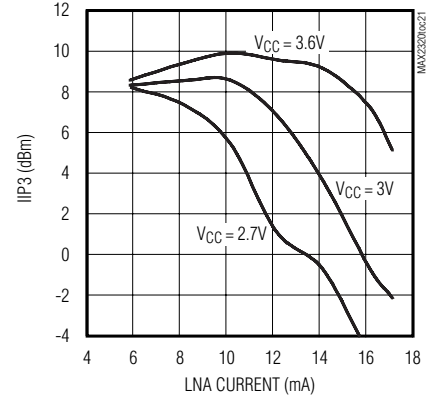

PCS-BAND HGHL LNA IIP3 vs. CURRENT

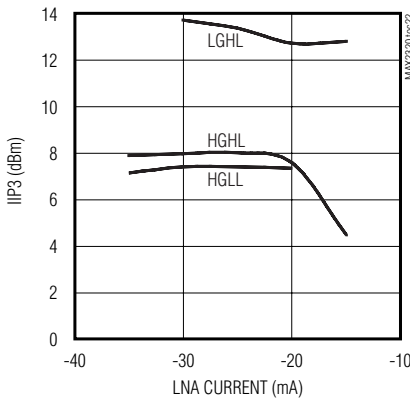

CELLULAR-BAND HGHL LNA NOISE FIGURE vs. FREQUENCY

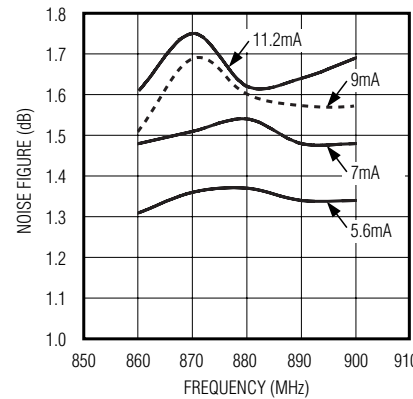

CELLULAR-BAND HGHL LNA NOISE FIGURE vs. FREQUENCY

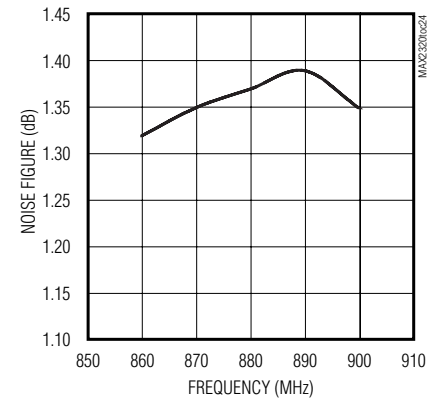

PCS-BAND HGHL NOISE FIGURE vs. FREQUENCY

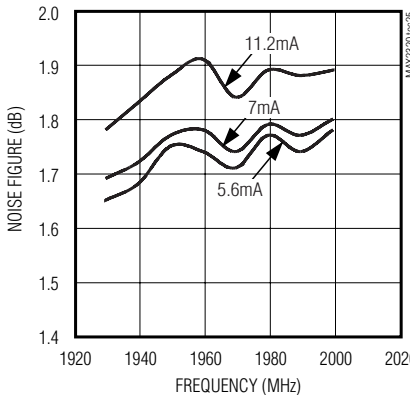

PCS-BAND HGLL LNA NOISE FIGURE vs. FREQUENCY

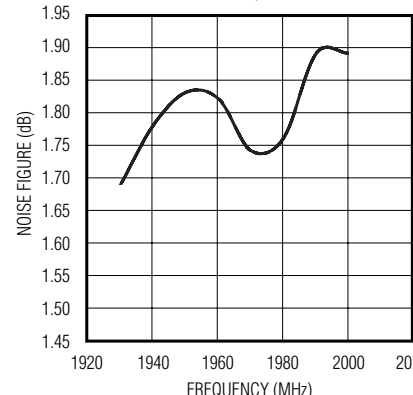

CELLULAR-BAND HGHL MIXER CONVERSION GAIN vs. CURRENT

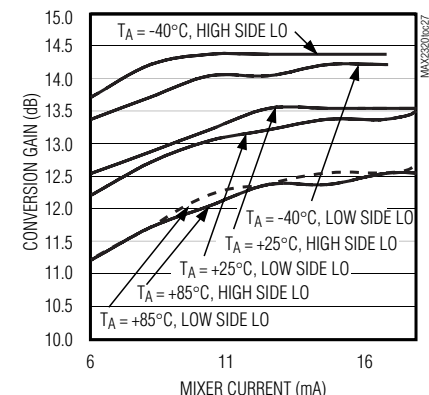

Adjustable, High-Linearity, SiGe Dual-Band LNA/Mixer ICs

Typical Operating Characteristics (continued)

(MAX232_EV kit, $V_{CC} = +2.75V$, $f_{LNAINH} = f_{MIXINH} = 1960MHz$, $f_{LNAINL} = f_{MIXINL} = 881MHz$, $f_{LOINH} = 1750MHz$, $f_{LOLIN} = 1091MHz$ (digital modes), $f_{LOLIN} = 991MHz$ (FM mode), LO input power = -7dBm, 50Ω system, all measurements include matching component losses but not connector and trace losses, $T_A = +25^\circ C$, unless otherwise noted.)

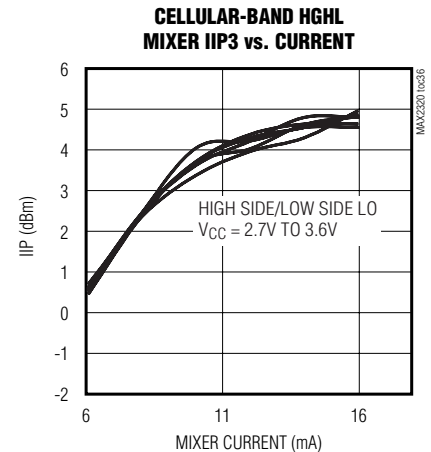
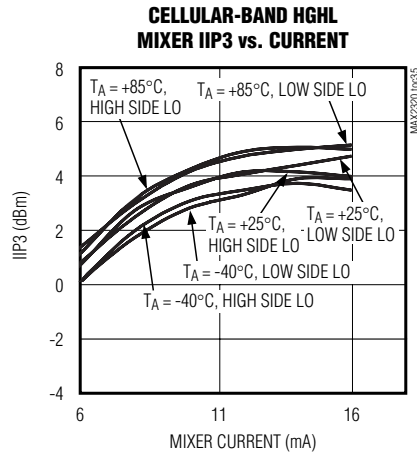
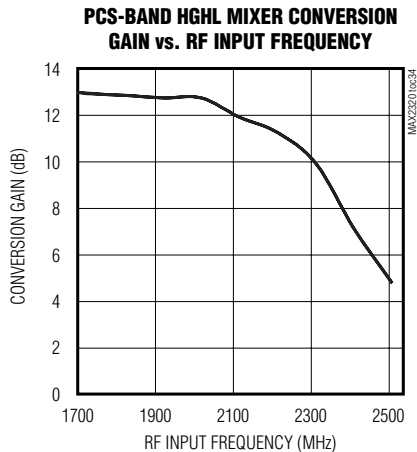
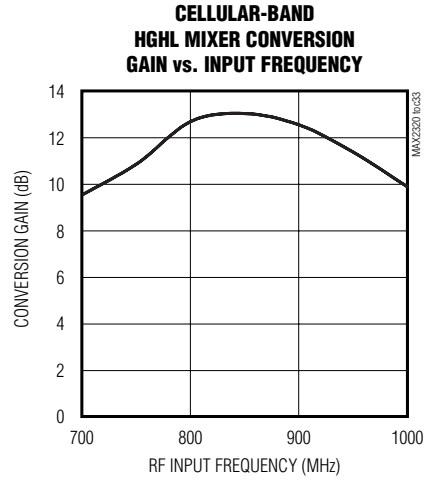
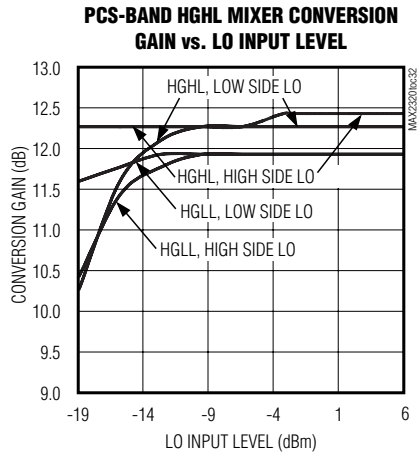
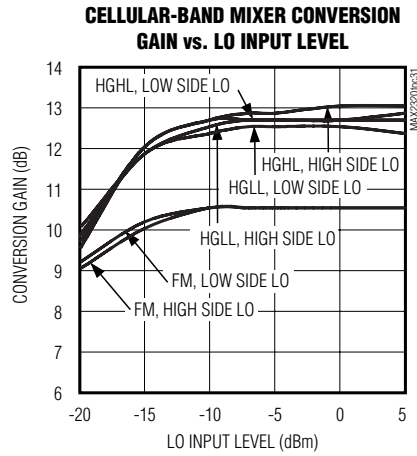
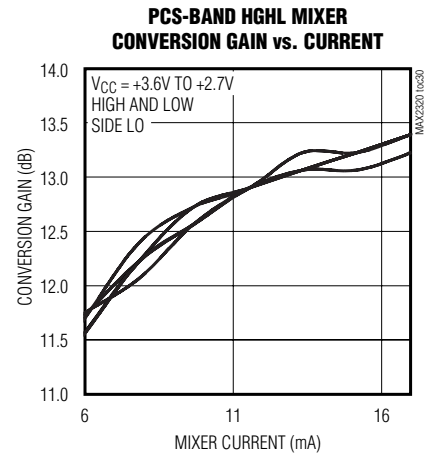
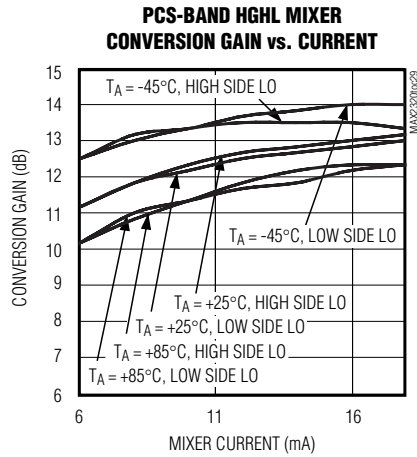
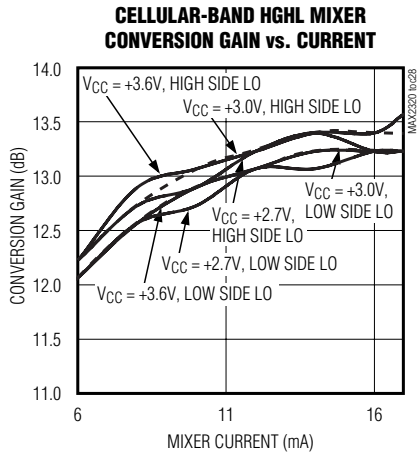

Adjustable, High-Linearity, SiGe Dual-Band LNA/Mixer ICs

Typical Operating Characteristics (continued)

(MAX232_ EV kit, $V_{CC} = +2.75V$, $f_{LNAINH} = f_{MIXINH} = 1960MHz$, $f_{LNAINL} = f_{MIXINL} = 881MHz$, $f_{LOHIN} = 1750MHz$, $f_{LOLIN} = 1091MHz$ (digital modes), $f_{LOLIN} = 991MHz$ (FM mode), LO input power = -7dBm, 50Ω system, all measurements include matching component losses but not connector and trace losses, $T_A = +25^\circ C$, unless otherwise noted.)

MAX2320/21/22/24/26/27

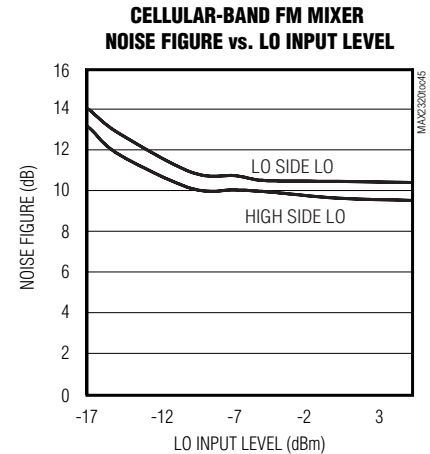
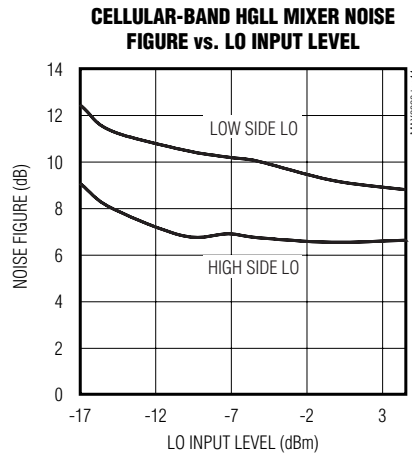
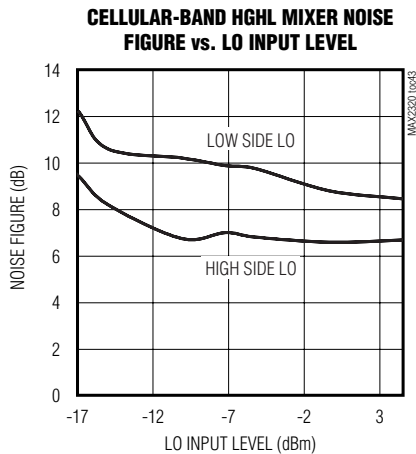
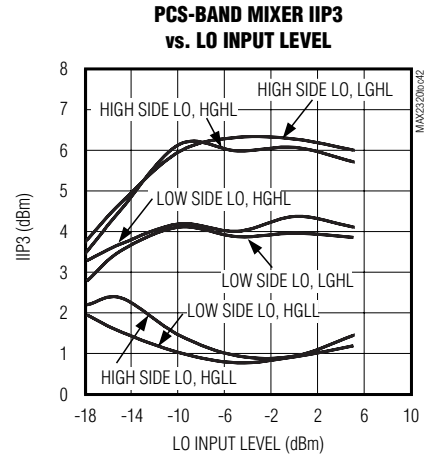
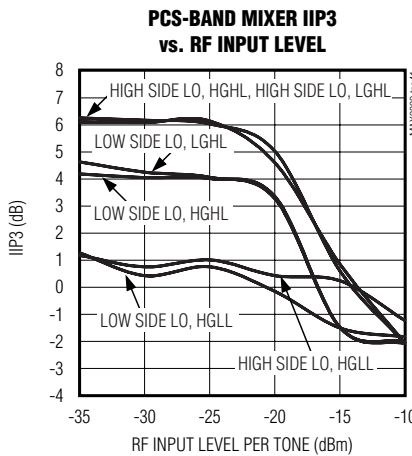
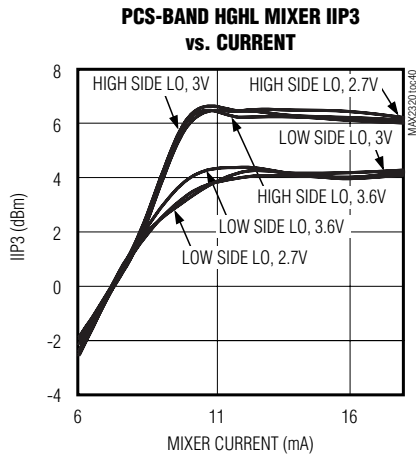
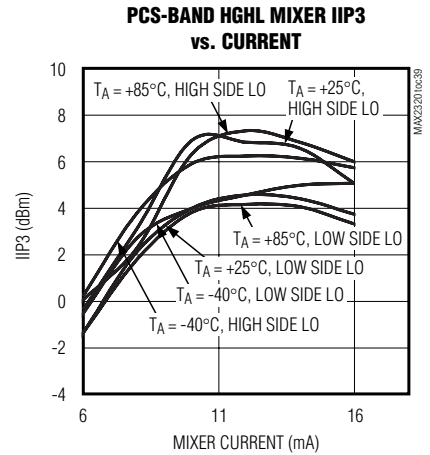
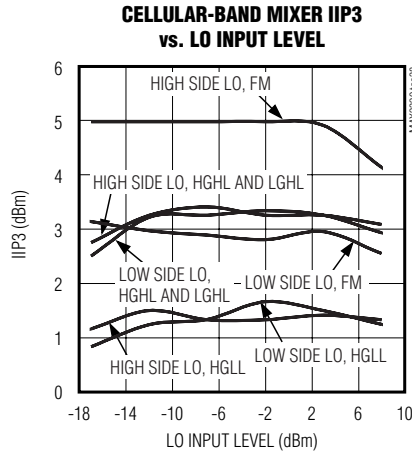
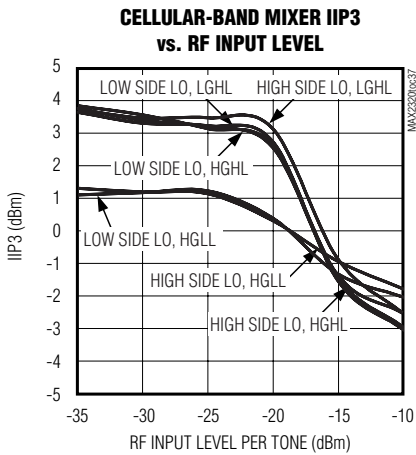

Adjustable, High-Linearity, SiGe Dual-Band LNA/Mixer ICs

Typical Operating Characteristics (continued)

(MAX2322_EV kit, $V_{CC} = +2.75V$, $f_{LNAINH} = f_{MIXINH} = 1960MHz$, $f_{LNAINL} = f_{MIXINL} = 881MHz$, $f_{LOHIN} = 1750MHz$, $f_{LOLIN} = 1091MHz$ (digital modes), $f_{LOLIN} = 991MHz$ (FM mode), LO input power = -7dBm, 50Ω system, all measurements include matching component losses but not connector and trace losses, $T_A = +25^\circ C$, unless otherwise noted.)

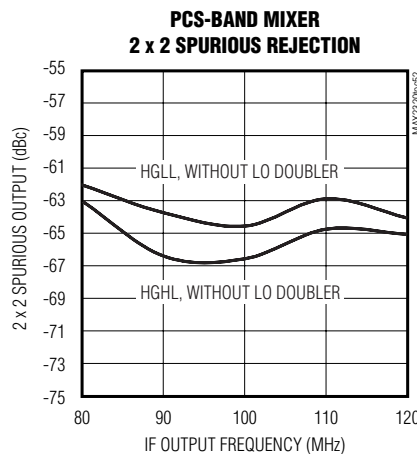
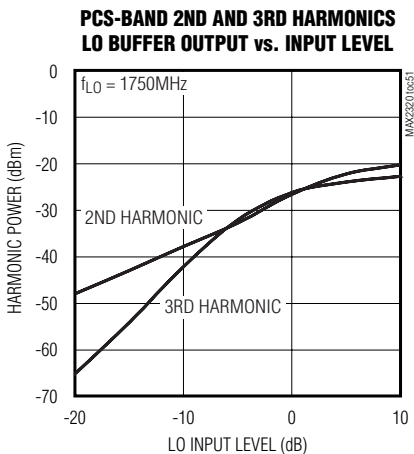
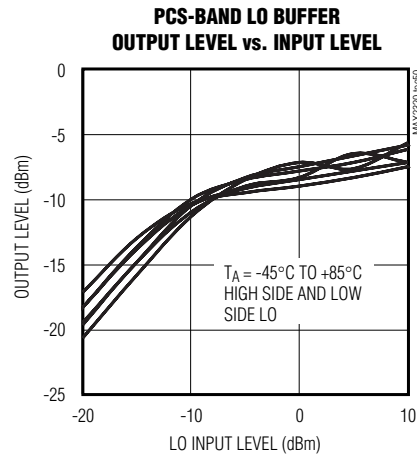
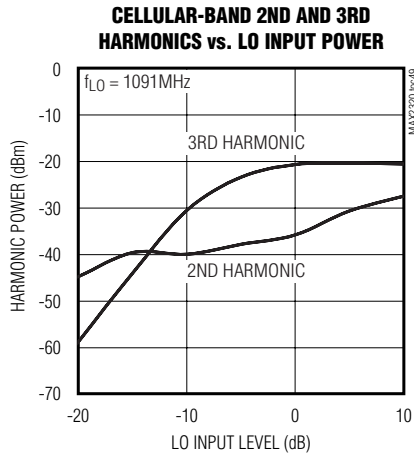
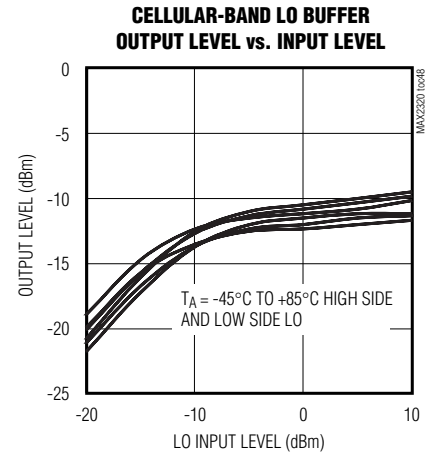
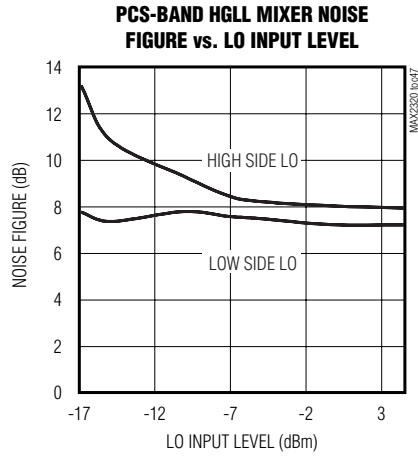
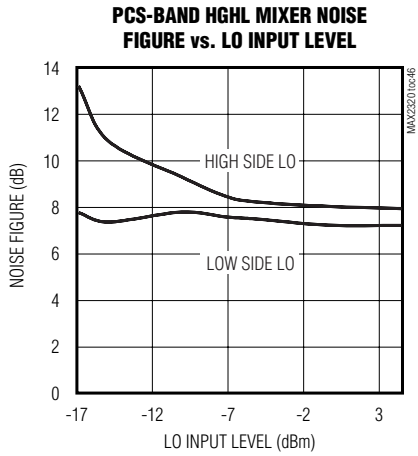

Adjustable, High-Linearity, SiGe Dual-Band LNA/Mixer ICs

Pin Description

MAX2320/21/22/24/26/27

| PIN | | | | NAME | FUNCTION |
|-------------------------------|---------|---------|---------|--------------------------|--|
| MAX2320 MAX2321 MAX2326 | MAX2322 | MAX2324 | MAX2327 | | |
| 1 | 1 | — | 1 | LNAOUTH | High-Band LNA Output. Connect a pull-up inductor to VCC and an external series capacitor as part of the matching network. |
| 2 | — | 2 | 2 | LNAOUTL | Low-Band LNA Output. Connect a pull-up inductor to VCC and an external series capacitor as part of the matching network. |
| 3 | 3 | 3 | — | RLNA | LNA Bias-Setting Resistor Connection. For nominal bias, connect a 20kΩ resistor to ground. The resistor value controls the LNA's linearity in high-gain, high-linearity modes. |
| 4 | 4 | — | 4 | LNAINH | High-Band RF Input. Requires a blocking capacitor and a matching network. The capacitor may be used as part of the matching network. |
| — | — | 4 | — | MODEOUT | Logic Output. Indicates mode of operation. VMODEOUT = high in FM mode. |
| 5 | — | 5 | 5 | LNAINL | Low-Band RF Input. Requires a blocking capacitor and a matching network. The capacitor may be used as part of the matching network. |
| — | 6 | 6 | 7 | $\overline{\text{SHDN}}$ | Shutdown Logic Input. See <i>Detailed Description</i> for control modes. |
| 6 | — | — | 6 | $\overline{\text{BAND}}$ | Band-Select Logic Input. See <i>Detailed Description</i> for control modes. |
| 7 | 7 | 7 | — | LIN | Linearity-Select Logic Input. See <i>Detailed Description</i> for control modes. |
| 8 | 8 | 8 | — | GAIN | Gain-Select Logic Input. See <i>Detailed Description</i> for control modes. |
| — | — | — | 8 | MODE | Cellular-Band Mode Select Logic Input. See <i>Detailed Description</i> for control modes. |
| 9 | — | 9 | 9 | LOLIN | Low-Frequency LO Input. Used in FM mode on all parts and in cellular digital mode for MAX2320/MAX2324. |
| 10 | 10 | — | 10 | LOHIN | High-Frequency LO Input. For MAX2321, used in cellular digital mode and in PCS mode with the doubler active. For MAX2320/MAX2327, used in PCS mode without the doubler. For MAX2322, used with or without the doubler. For MAX2326, used in PCS mode and cellular digital mode with the divide-by-two. |

Adjustable, High-Linearity, SiGe Dual-Band LNA/Mixer ICs

Pin Description (continued)

| PIN | | | | NAME | FUNCTION |
|-------------------------------|--------------------|---------------|---------|-------------------|--|
| MAX2320 MAX2321 MAX2326 | MAX2322 | MAX2324 | MAX2327 | | |
| 11 | 11 | — | 11 | LOHOUT | High-Frequency LO Buffer Output. Open-collector output requires pull-up inductor or pull-up resistor of 100Ω or less. Reactive match to the load delivers maximum power. |
| 12 | — | 12 | 12 | LOLOUT | Low-Frequency LO Buffer Output. Open-collector output requires pull-up inductor or pull-up resistor of 100Ω or less. Reactive match to the load delivers maximum power. |
| 13 | — | 13 | 13 | FMOUT | FM Mixer Output. Requires a pull-up inductor to V _{CC} and a series capacitor as part of the matching network. |
| — | 13 | — | — | LOX2 | LO Doubler Logic Input. Drive LOX2 high to enable the LO doubler. |
| 14 | 14 | 14 | 14 | V _{CC} | Power Supply. Bypass with a 1000pF capacitor as close to the pin as possible. |
| 15 | 15 | 15 | 15 | BUFFEN | LO Output Buffer Enable. The LO buffers are controlled separately from the rest of the IC. Drive BUFFEN high to power up the LO output buffer associated with the selected LO input port. |
| 16, 17 | 16, 17 | 16, 17 | — | CDMA-, CDMA+ | CDMA Mixer Differential Outputs. Require pull-up inductors and series capacitors as part of the matching network. |
| — | — | — | 16, 17 | IFOUT+, IFOUT- | Mixer Differential Outputs. Require pull-up inductors and series capacitors as part of the matching network. |
| 18 | 18 | 18 | 18 | RBIAS | Bias-Setting Resistor Connection. For nominal bias, connect 20kΩ resistor to ground. The resistor value controls the digital LNA's linearity in low-gain, digital, or FM mode, and controls the mixers in all modes. |
| 19 | — | 19 | 19 | MIXINL | Low-Band Mixer Input. Requires a blocking capacitor and a matching network. The capacitor may be used as part of the matching network. |
| 20 | 20 | — | 20 | MIXINH | High-Band Mixer Input. Requires a blocking capacitor and a matching network. The capacitor may be used as part of the matching network. |
| — | 2, 5, 9, 12, 19 | 1, 10, 11, 20 | 3 | N.C. | No Connection. Do not make any connection to these pins. |
| Slug | Slug | Slug | Slug | GND | Ground Reference for RF, DC, and Logic Inputs. Solder the slug evenly to the board ground plane. |

Adjustable, High-Linearity, SiGe Dual-Band LNA/Mixer ICs

MAX2320/21/22/24/26/27

Detailed Description

Low-Noise Amplifier

Within its operating bands, each device in the MAX2320 family (except the MAX2327) has three modes of LNA operation: high gain, high linearity (HGHL); high gain, low linearity (HGLL); and low gain, high linearity (LGHL). The logic inputs control the LNA mode as described in the *AC Electrical Characteristics*. Use HGHL mode when extra-high LNA linearity is required for cross-modulation suppression. Use HGLL mode when the transmitter is off and cross-modulation is not a concern. When the LNA changes modes, the input VSWR change is minimal. Use LGHL mode for receiving large signals and when high sensitivity is not required. The MAX2327 LNA has only an HGLL mode. Adjust the HGHL mode LNA linearity by changing RRLNA, and adjust linearity of the other modes by changing RRBias.

Downconverter

The downconverters in these devices are double-balanced mixers. The PCS-band mixer and digital cellular-band mixer share the same IF output ports. The cellular band FM mixer has its own IF output to feed a different filter. Adjust the downconverter linearity and current by changing RRBias (see *Typical Operating Characteristics*). When the linearity requirement is high, the mode

control inputs increase the current in the downconverter. When the linearity requirement is not high, the current is lower.

LO Output Buffers

The BUFFEN logic input turns the open-collector LO output buffers on and off. This feature saves current if the buffers are not required.

Operational Modes

Each device has logic input pins that control the different operational modes listed in Tables 1–5.

MAX2320/MAX2321/MAX2326 Operation

The MAX2320/MAX2321/MAX2326 are dual-band, triple-mode receivers that amplify and downconvert cellular- and PCS-band signals. They consist of cellular and PCS LNAs; cellular digital, cellular FM, and PCS digital mixers; and cellular and PCS LO buffers. The MAX2321 has an LO frequency doubler on-chip, so a single cellular-band VCO can be used for both the cellular- and PCS-band mixers. Selecting the PCS path activates the LO frequency doubler. The MAX2326 has an LO divide-by-two circuit, so a single PCS-band VCO can be used for both the cellular and PCS mixers. Selecting the cellular path activates the LO divide-by-two circuit. Three logic input pins—BAND, GAIN, and LIN—control eight operational modes of the LNAs and mixers. The modes are summarized in Table 1.

Table 1. MAX2320/MAX2321/MAX2326 Operational Modes

| DESCRIPTION | $\overline{\text{BAND}}$ | GAIN | LIN |
|---|--------------------------|------|-----|
| Shutdown. The entire part is shut down except for the LO buffer, which is controlled by BUFFEN. | L | L | L |
| Low-Gain, High-Linearity (LGHL) PCS Mode. The PCS LNA and mixer are in LGHL mode. | L | L | H |
| High-Gain, Low-Linearity (HGLL) PCS Mode. The LNA and mixer are in HGLL mode. | L | H | L |
| High-Gain, High-Linearity (HGHL) PCS Mode. The LNA and mixer are in HGHL mode. | L | H | H |
| High-Gain, Low-Linearity (HGLL) Cellular FM Mode. The cellular LNA is in HGLL mode. The FM mixer and associated LO buffer are selected. | H | L | L |
| Low-Gain, High-Linearity (LGHL) Cellular Digital Mode. The cellular LNA and mixer are in LGHL mode. | H | L | H |
| High-Gain, Low-Linearity (HGLL) Cellular Digital Mode. The cellular LNA and mixer are in HGLL mode. | H | H | L |
| High-Gain, High-Linearity (HGHL) Cellular Digital Mode. The cellular LNA and mixer are in HGHL mode. | H | H | H |

Note: L = Logic Low; H = Logic High

Adjustable, High-Linearity, SiGe Dual-Band LNA/Mixer ICs

MAX2322 Operation

The MAX2322 is a lower-cost PCS-only version that can be installed as a drop-in replacement for the dual-band versions. It consists of a PCS LNA, PCS mixer, pin-selectable LO frequency doubler, and LO buffer. Logic input $\overline{\text{SHDN}} = \text{VCC} / \text{GND}$ turns on/off the entire IC except the LO buffer. The LOX2 logic input controls the LO frequency doubler. LOX2 = GND disables the doubler when using a PCS band VCO, and LOX2 = VCC activates the doubler when using a cellular-band VCO. GAIN and LIN logic inputs control the MAX2322's three operational modes, as summarized in Table 2.

MAX2324 Operation

The MAX2324 is a lower-cost cellular-only version that can be installed as a drop-in replacement for the dual-band versions. It consists of a cellular LNA, cellular digital mixer, cellular FM mixer, and LO buffer. A $\overline{\text{SHDN}}$ logic input turns on/off the entire IC except the LO buffer. GAIN and LIN logic inputs control the MAX2324's three operational modes, as summarized in Table 3.

MAX2327 Operation

The MAX2327 is similar to the MAX2320 except it only features an HGLL mode, and either LO output buffer is selectable during shutdown. It consists of PCS and cellular LNAs; PCS, cellular digital, and cellular FM mixers; and PCS and cellular LO buffers. A $\overline{\text{SHDN}}$ logic input turns on/off the entire IC except the LO buffer. BAND and MODE logic inputs control the MAX2327's three operational modes, as summarized in Table 4.

Applications Information

Cascaded LNA/Mixer Performance

The LNA and mixer design aims at optimizing cascaded performance in all gain and linearity modes. In high-gain, high-linearity mode, both the LNA and mixer have a low noise figure, high gain, and high linearity. The LNA has high gain to minimize the noise contribution of the mixer, thus increasing the receiver's sensitivity and extra-high linearity for superior cross-modulation suppression. The HGLL mode is used when the transmitter is off and cross-modulation is not a concern. In low-gain, high-linearity mode, the received signal is strong enough that linearity is the primary concern. The LNA gain is reduced for higher system linearity. Tables 5 and 6 summarize the cascaded performance.

S Parameters

The S parameters are listed in Tables 7–11. An electronic copy is also available at www.maxim-ic.com/MAX2320/S_table/.

Table 2. MAX2322 Operational Modes

| OPERATIONAL MODE | GAIN | LIN |
|--|------|-----|
| Not used. | L | L |
| Low-Gain, High-Linearity (LGHL) PCS Mode. The LNA and mixer are in LGHL mode. | L | H |
| High-Gain, Low-Linearity (HGLL) PCS Mode. The LNA and mixer are in HGLL mode. | H | L |
| High-Gain, High-Linearity (HGHL) PCS Mode. The LNA and mixer are in HGHL mode. | H | H |

Note: L = Logic Low; H = Logic High

Table 3. MAX2324 Operational Modes

| OPERATIONAL MODE | GAIN | LIN |
|---|------|-----|
| FM Mode. The LNA is in HGLL mode. The FM mixer and the associated LO buffer are selected. | L | L |
| Low-Gain, High-Linearity (LGHL) Cellular Mode. The LNA and digital mixer are in LGHL mode. | L | H |
| High-Gain, Low-Linearity (HGLL) Cellular Mode. The LNA and digital mixer are in HGLL mode. | H | L |
| High-Gain, High-Linearity (HGHL) Cellular Mode. The LNA and digital mixer are in HGHL mode. | H | H |

Note: L = Logic Low; H = Logic High

Table 4. MAX2327 Operational Modes

| OPERATIONAL MODE | $\overline{\text{BAND}}$ | MODE |
|--|--------------------------|------|
| Not used. | L | L |
| Digital PCS Mode. The LNA and mixer are in HGLL mode. | L | H |
| FM Mode. The cellular FM mixer is selected. | H | L |
| Digital Cellular Mode. The cellular digital mixer is selected. | H | H |

Note: L = Logic Low; H = Logic High

Adjustable, High-Linearity, SiGe Dual-Band LNA/Mixer ICs

Layout Considerations

Keep RF signal lines as short as possible to minimize losses and radiation. Use high-Q components for the LNA input matching circuit to achieve the lowest possible

noise figure. At the digital mixer outputs, keep the differential signal lines together and of equal length to ensure signal balance. For best gain and noise performance, solder the slug evenly to the board ground plane.

MAX2320/21/22/24/26/27

Table 5. Typical Cascaded Performance of Cellular-Band Receiver with 3dB Interstage Filter Loss

| PARAMETER | HIGH GAIN, HIGH LINEARITY | HIGH GAIN, LOW LINEARITY | LOW GAIN, HIGH LINEARITY | FM |
|-----------------------------|---------------------------|--------------------------|--------------------------|---------|
| Conversion Power Gain | 25.4dB | 24.5dB | 8.9dB | 22.7dB |
| Noise Figure | 2.1dB | 2.3dB | 11.8dB | 3.3dB |
| Third-Order Input Intercept | -8.9dBm | -10.6dBm | -6.8dBm | -6.8dBm |

Table 6. Typical Cascaded Performance of PCS-Band Receiver with 3dB Interstage Filter Loss

| PARAMETER | HIGH GAIN, HIGH LINEARITY | HIGH GAIN, LOW LINEARITY | LOW GAIN |
|-----------------------------|---------------------------|--------------------------|----------|
| Conversion Power Gain | 24dB | 22.5dB | 7.5dB |
| Noise Figure | 2.6dB | 3.0dB | 12.4dB |
| Third-Order Input Intercept | -7.6dBm | -9.3dBm | 7.1dBm |

Table 7. Cellular LNA S Parameters in High-Gain, High-Linearity Mode

| FREQUENCY (MHz) | S11 (mag) | S11 (phase) | S21 (mag) | S21 (phase) | S12 (mag) | S12 (phase) | S22 (mag) | S22 (phase) |
|-----------------|-----------|-------------|-----------|-------------|-----------|-------------|-----------|-------------|
| 700 | 0.579 | -74.8 | 4.63 | 92.1 | 0.085 | 60.9 | 0.714 | -34.7 |
| 750 | 0.548 | -78.4 | 4.39 | 87.9 | 0.089 | 60.6 | 0.696 | -35.9 |
| 800 | 0.534 | -81.2 | 4.13 | 84.4 | 0.0908 | 60 | 0.689 | -36.6 |
| 850 | 0.52 | -83.7 | 3.88 | 81.9 | 0.096 | 60.1 | 0.683 | -37.6 |
| 900 | 0.51 | -86.1 | 3.7 | 79.4 | 0.099 | 58.8 | 0.677 | -38.3 |
| 950 | 0.503 | -88.5 | 3.5 | 76.6 | 0.104 | 58.3 | 0.674 | -39.3 |
| 1000 | 0.496 | -90.6 | 3.3 | 74.9 | 0.109 | 59.1 | 0.669 | -40.8 |

Adjustable, High-Linearity, SiGe Dual-Band LNA/Mixer ICs

Table 8. PCS LNA S Parameters in High-Gain, High-Linearity Mode

| FREQUENCY (MHz) | S11 (mag) | S11 (phase) | S21 (mag) | S21 (phase) | S12 (mag) | S12 (phase) | S22 (mag) | S22 (phase) |
|--------------------|--------------|----------------|--------------|----------------|--------------|----------------|--------------|----------------|
| 1700 | 0.46 | -112 | 4.22 | 86 | 0.077 | 77 | 0.64 | -51 |
| 1750 | 0.446 | -113 | 4.07 | 88 | 0.082 | 77 | 0.64 | -52 |
| 1800 | 0.44 | -113 | 4.18 | 88 | 0.086 | 76 | 0.643 | -52 |
| 1850 | 0.439 | -113 | 4.23 | 84 | 0.09 | 77 | 0.657 | -53 |
| 1900 | 0.434 | -114 | 3.9 | 82 | 0.093 | 72 | 0.68 | -55 |
| 1950 | 0.43 | -115 | 3.82 | 84 | 0.09 | 75 | 0.673 | -57 |
| 2000 | 0.423 | -116 | 3.85 | 83 | 0.094 | 76 | 0.681 | -58 |
| 2050 | 0.407 | -115 | 3.82 | 83 | 0.098 | 76 | 0.69 | -59 |
| 2100 | 0.391 | -112 | 3.82 | 81 | 0.103 | 74 | 0.7 | -61 |
| 2150 | 0.405 | -106 | 3.68 | 79 | 0.101 | 71 | 0.695 | -63 |
| 2200 | 0.467 | -104 | 3.56 | 81 | 0.093 | 73 | 0.677 | -64 |
| 2250 | 0.503 | -107 | 3.67 | 82 | 0.094 | 79 | 0.683 | -63 |
| 2300 | 0.525 | -110 | 3.83 | 81 | 0.099 | 82 | 0.705 | -64 |
| 2350 | 0.54 | -112 | 3.88 | 78 | 0.1 | 86 | 0.727 | -66 |
| 2400 | 0.55 | -113 | 3.9 | 75 | 0.106 | 93 | 0.739 | -67 |
| 2450 | 0.571 | -113 | 3.79 | 73 | 0.126 | 99 | 0.754 | -69 |
| 2500 | 0.614 | -113 | 3.78 | 74 | 0.158 | 100 | 0.769 | -71 |

Table 9. Cellular Mixer S11 in High-Gain,
High-Linearity Mode

| FREQUENCY (MHz) | S11 (mag) | S11 (phase) |
|--------------------|--------------|----------------|
| 700 | 0.853 | -35.8 |
| 750 | 0.849 | -38 |
| 800 | 0.846 | -40.2 |
| 850 | 0.844 | -42.2 |
| 900 | 0.843 | -44.1 |
| 950 | 0.842 | -46.3 |
| 1000 | 0.842 | -48.5 |

Adjustable, High-Linearity, SiGe Dual-Band LNA/Mixer ICs

MAX2320/21/22/24/26/27

Table 10. PCS Mixer S11 in High-Gain High-Linearity Mode

| FREQUENCY (MHz) | S11 (mag) | S11 (phase) |
|-----------------|-----------|-------------|
| 1700 | 0.865 | -62 |
| 1750 | 0.864 | -63 |
| 1800 | 0.865 | -64 |
| 1850 | 0.867 | -64 |
| 1900 | 0.863 | -65 |
| 1950 | 0.862 | -65 |
| 2000 | 0.861 | -66 |
| 2050 | 0.879 | -67 |
| 2100 | 0.86 | -68 |
| 2150 | 0.858 | -68 |
| 2200 | 0.854 | -69 |
| 2250 | 0.85 | -71 |
| 2300 | 0.845 | -72 |
| 2350 | 0.838 | -74 |
| 2400 | 0.83 | -76 |
| 2450 | 0.825 | -78 |
| 2500 | 0.805 | -82 |

Table 11. Mixer IF Port S22

| FREQUENCY (MHz) | DIGITAL MIXER | | FREQUENCY (MHz) | FM MIXER | |
|-----------------|---------------|-------------|-----------------|-----------|-------------|
| | S22 (mag) | S22 (phase) | | S22 (mag) | S22 (phase) |
| 50 | 0.999 | -1.10 | 50 | 0.999 | -1.69 |
| 100 | 0.999 | -2.26 | 70 | 0.998 | -2.38 |
| 110 | 0.999 | -2.46 | 85 | 0.998 | -2.92 |
| 130 | 0.998 | -2.89 | 100 | 0.997 | -3.38 |
| 150 | 0.998 | -3.35 | 110 | 0.997 | -3.71 |
| 200 | 0.998 | -4.45 | 150 | 0.996 | -4.97 |
| 210 | 0.998 | -4.67 | 200 | 0.995 | -6.49 |
| 250 | 0.997 | -5.48 | 250 | 0.995 | -7.82 |
| 300 | 0.997 | -6.48 | 300 | 0.994 | -9.06 |
| 350 | 0.996 | -7.47 | 350 | 0.993 | -10.28 |
| 400 | 0.996 | -8.36 | 400 | 0.992 | -11.40 |

Adjustable, High-Linearity, SiGe Dual-Band LNA/Mixer ICs

Typical Application Circuits

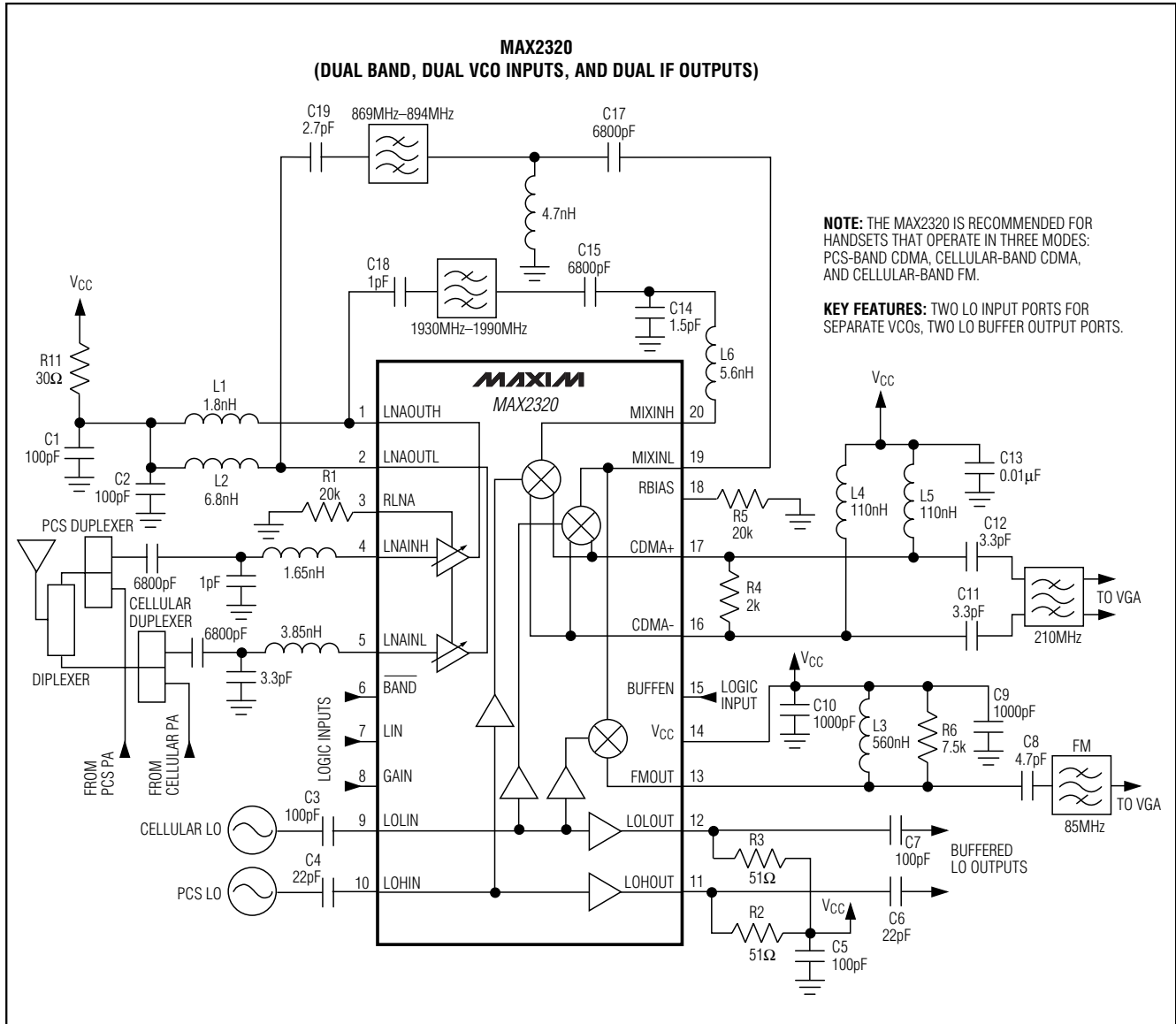

Adjustable, High-Linearity, SiGe Dual-Band LNA/Mixer ICs

Typical Application Circuits (continued)

MAX2320/21/22/24/26/27

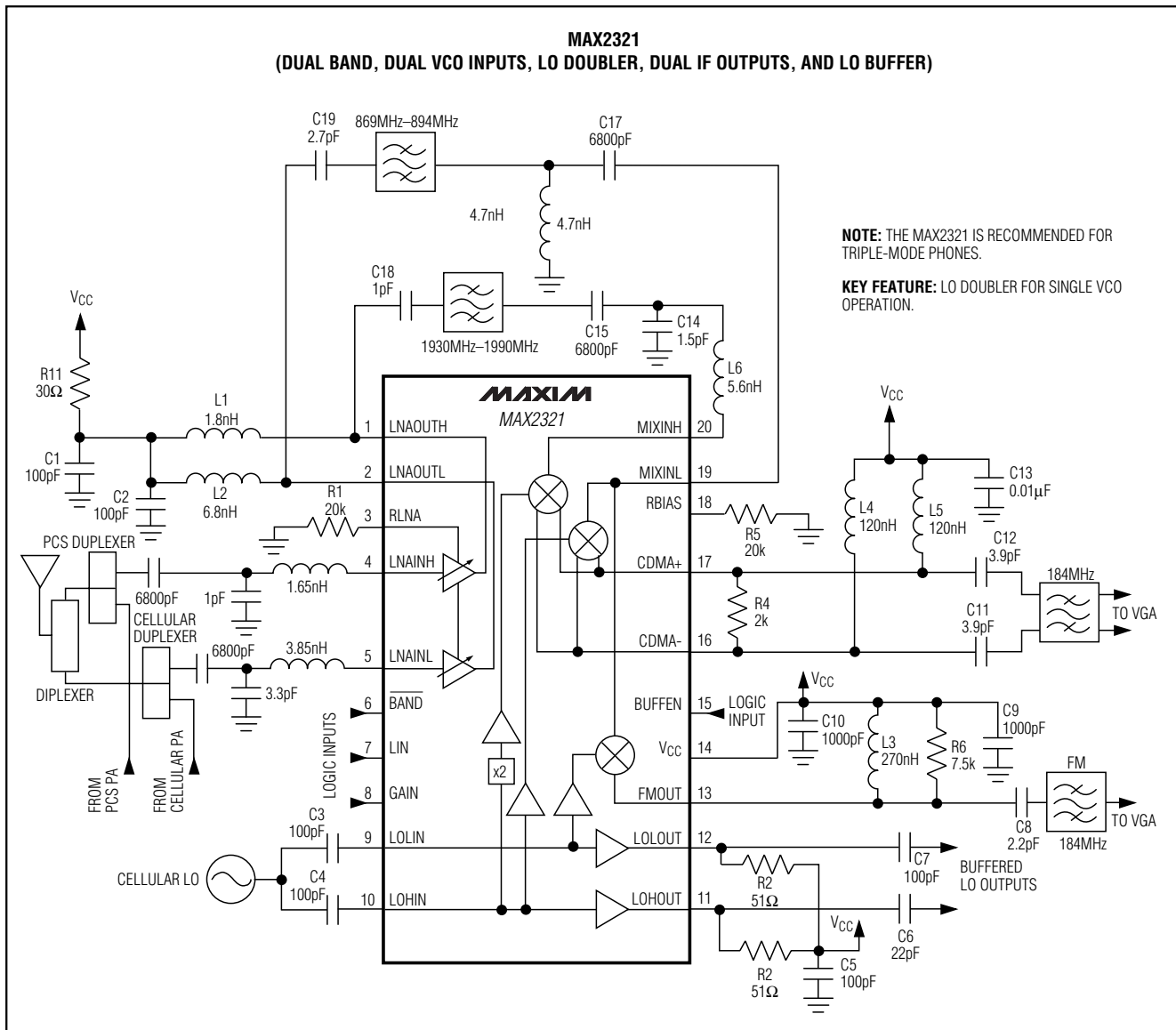

Adjustable, High-Linearity, SiGe Dual-Band LNA/Mixer ICs

Typical Application Circuits (continued)

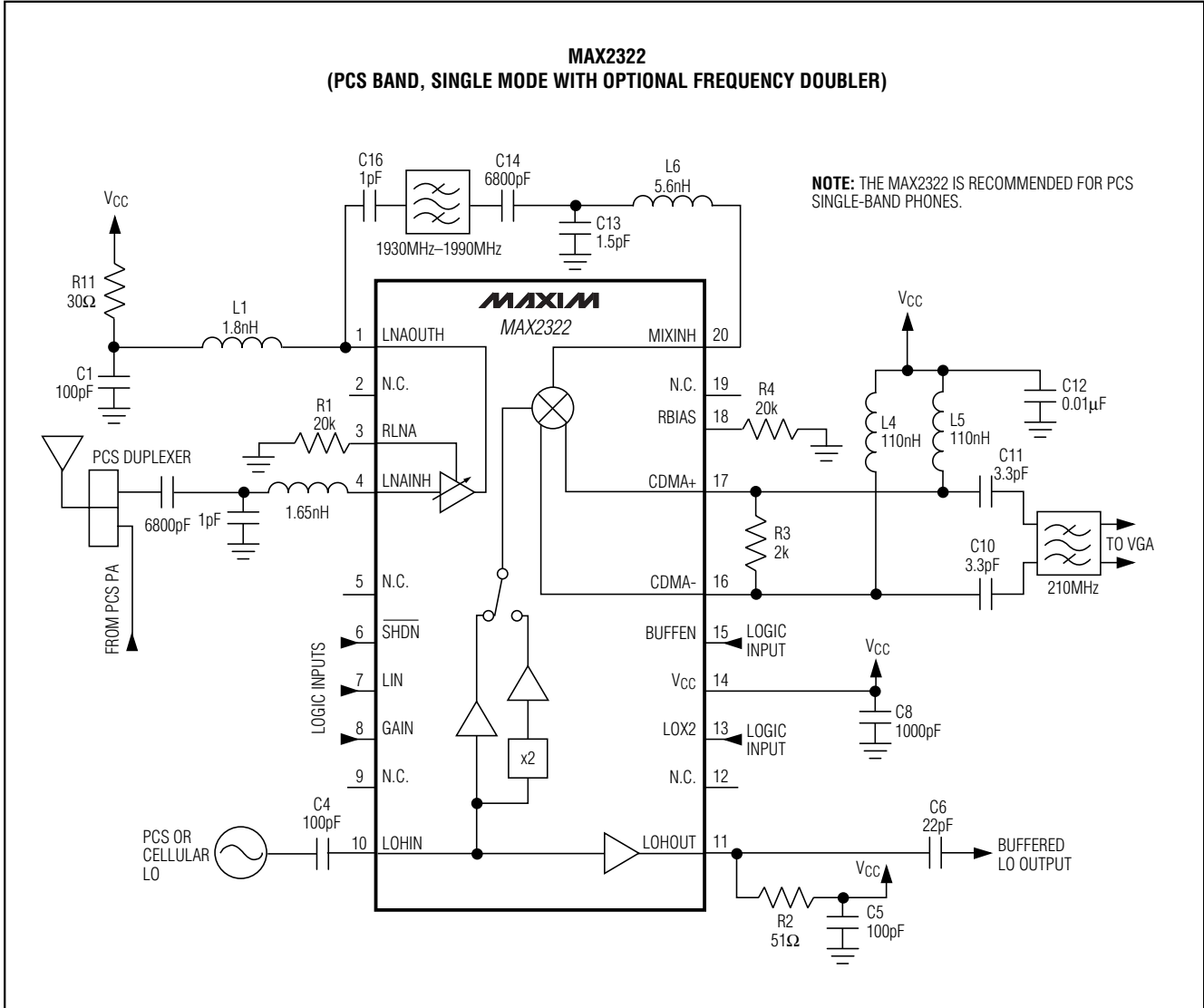

Adjustable, High-Linearity, SiGe Dual-Band LNA/Mixer ICs

Typical Application Circuits (continued)

MAX2320/21/22/24/26/27

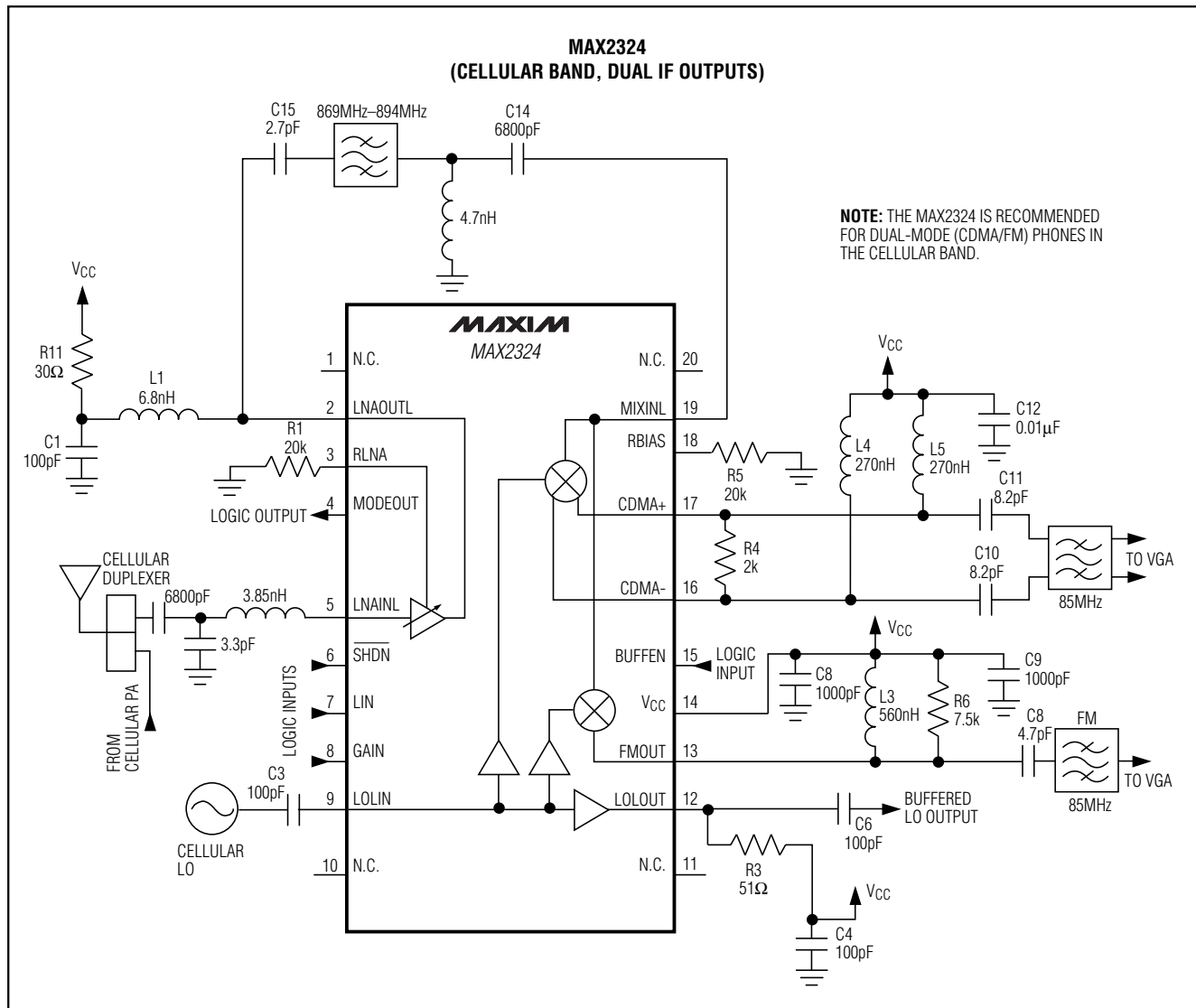

Adjustable, High-Linearity, SiGe Dual-Band LNA/Mixer ICs

Typical Application Circuits (continued)

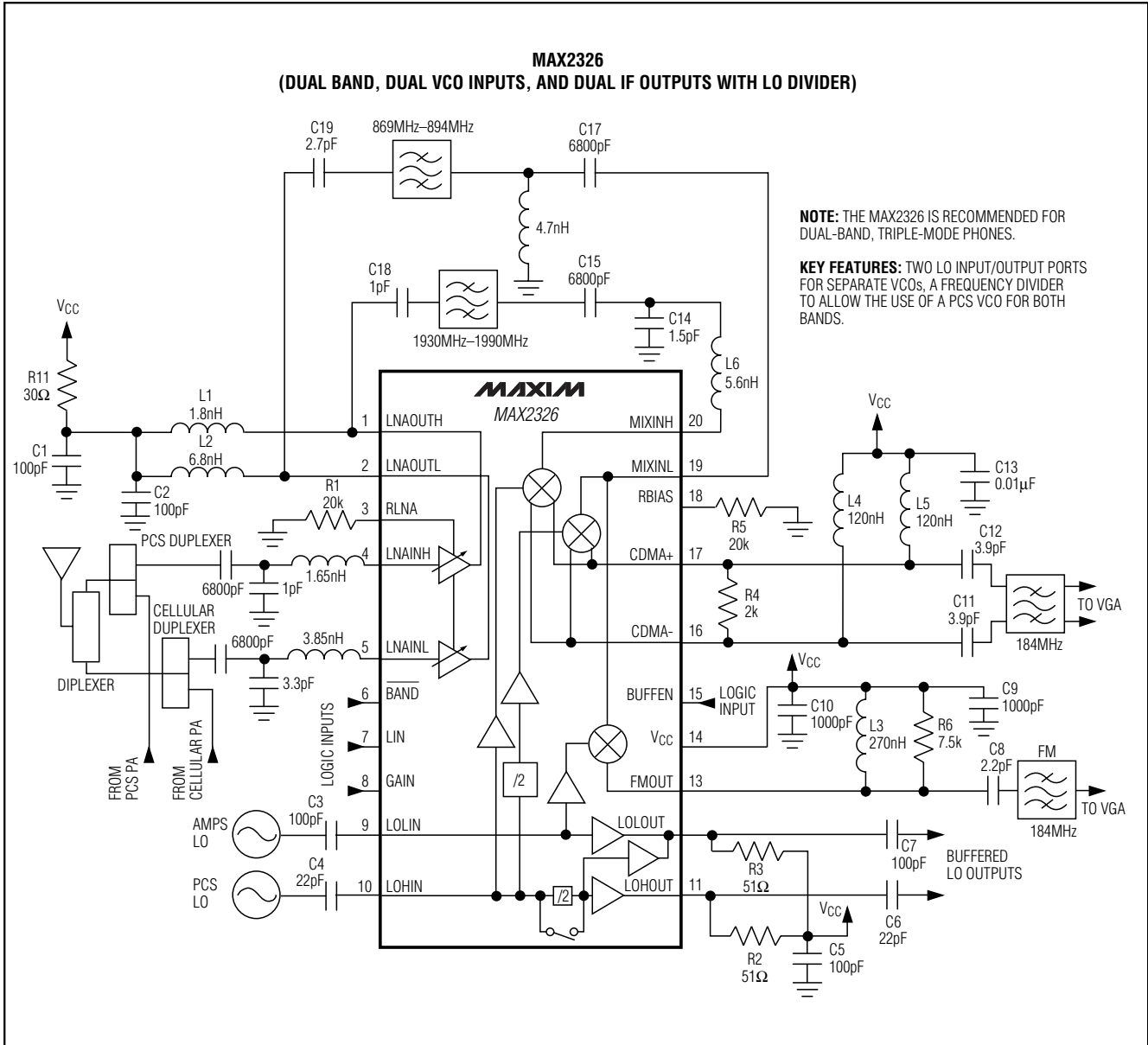

Adjustable, High-Linearity, SiGe Dual-Band LNA/Mixer ICs

Typical Application Circuits (continued)

MAX2320/21/22/24/26/27

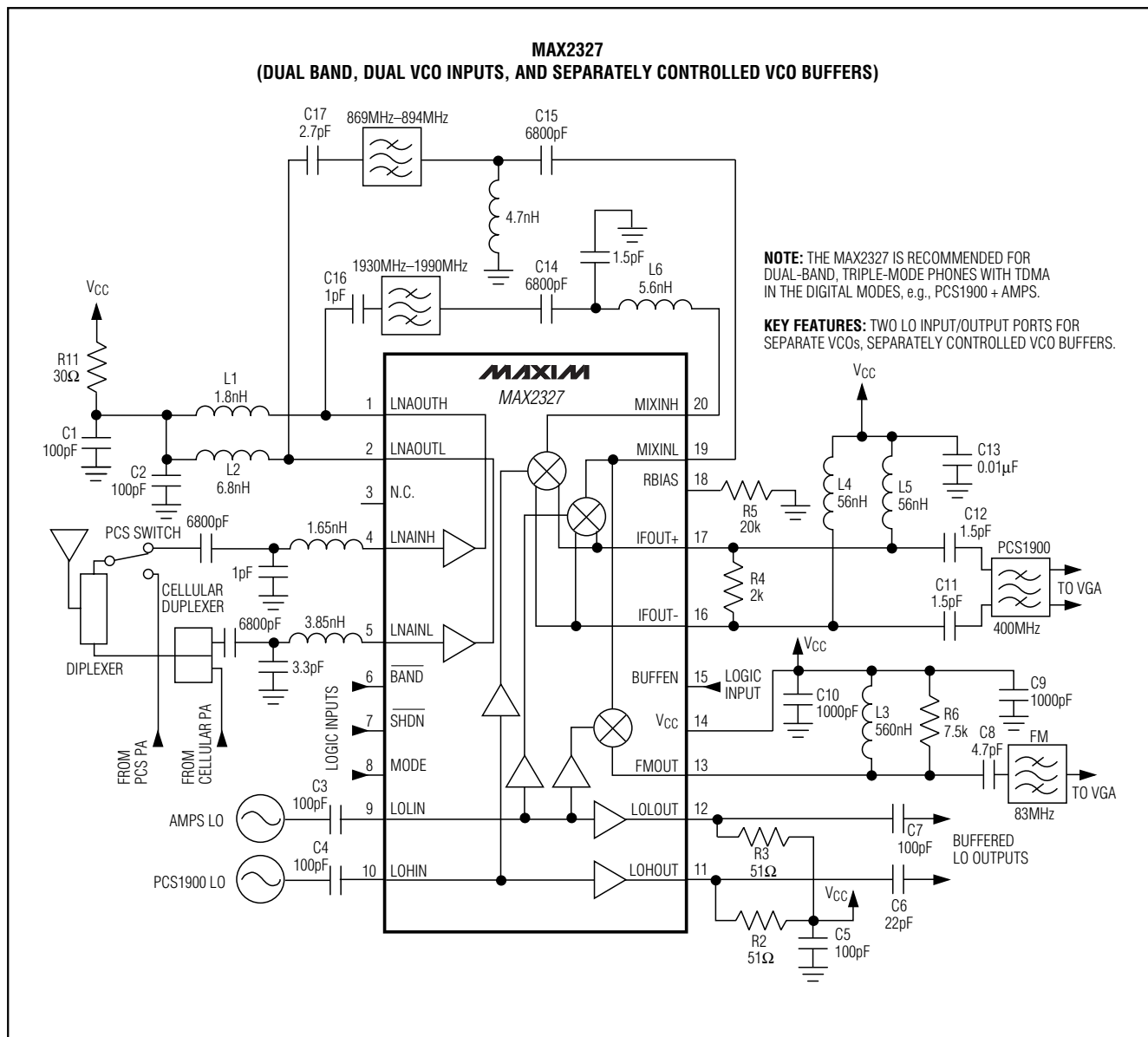

Adjustable, High-Linearity, SiGe Dual-Band LNA/Mixer ICs

Pin Configurations (continued)

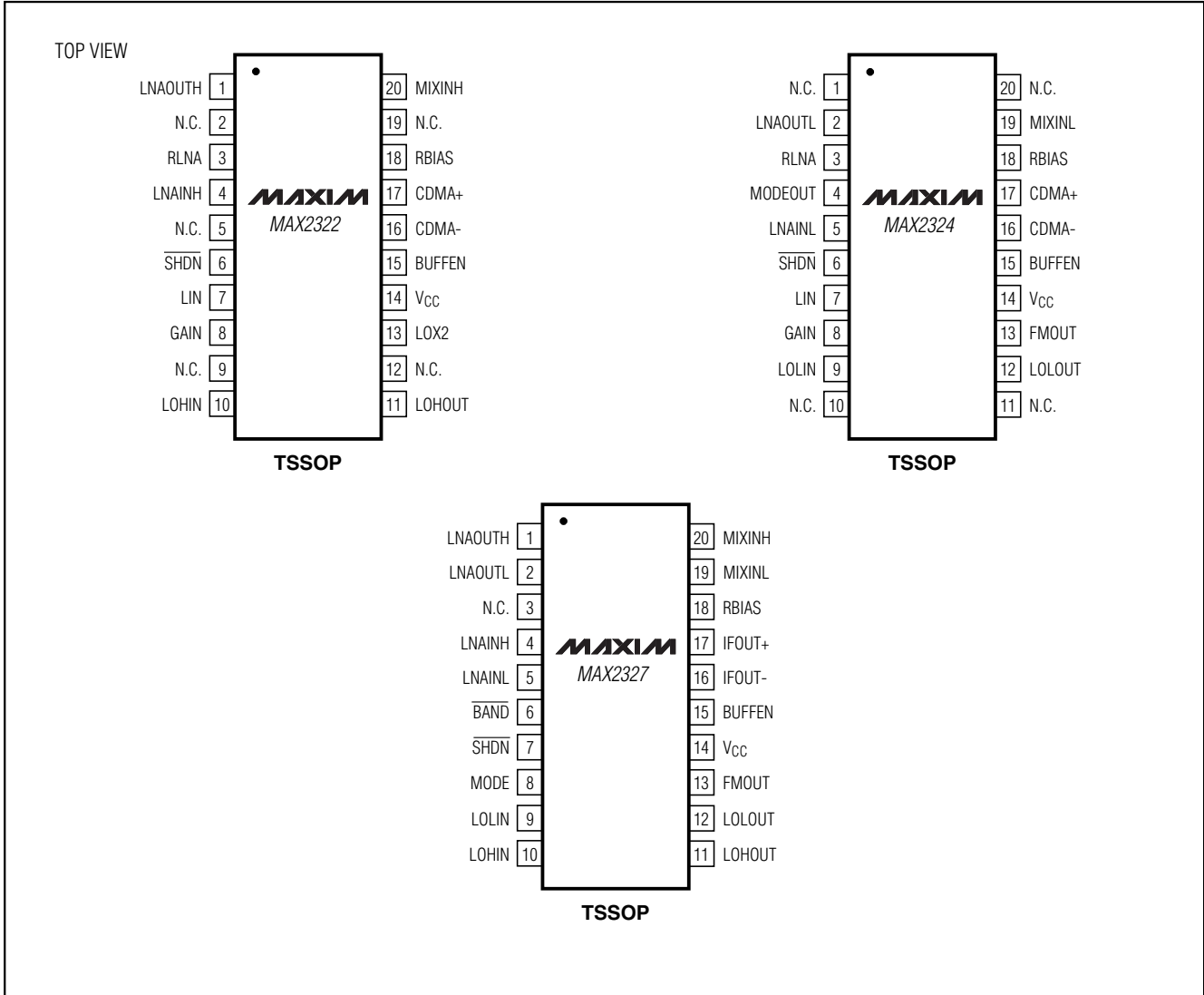

Chip Information

TRANSISTOR COUNT: 1315

Adjustable, High-Linearity, SiGe Dual-Band LNA/Mixer ICs

Package Information

MAX2320/21/22/24/26/27

TSSOP-EPS

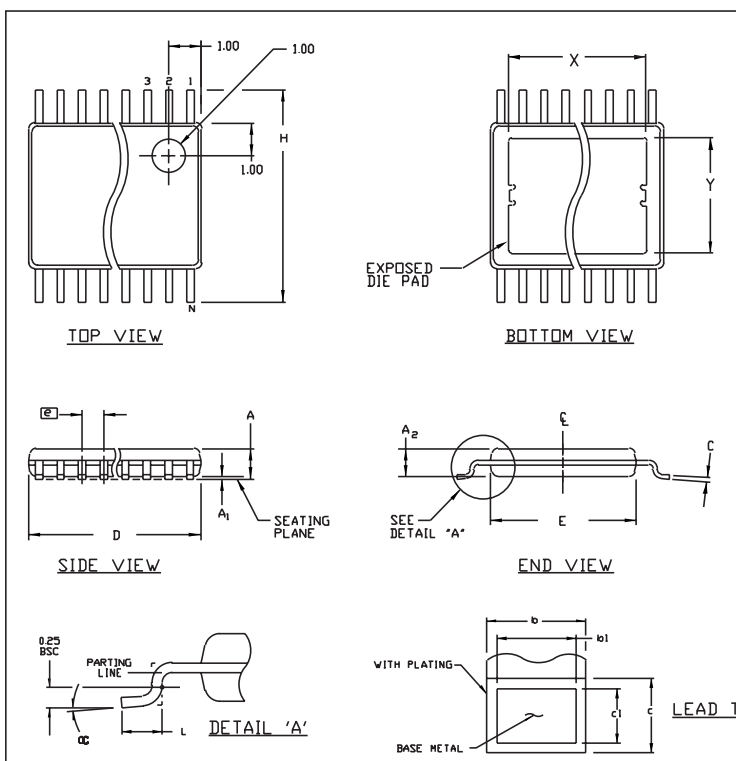

| | COMMON DIMENSIONS | | | |
|----------------|-------------------|----------------|----------------|----------------|
| | MILLIMETERS | | INCHES | |
| | MIN. | MAX. | MIN. | MAX. |
| A | — | 1.10 | — | .043 |
| A ₁ | 0.05 | 0.15 | .002 | .006 |
| A ₂ | 0.85 | 0.95 | .033 | .037 |
| b | 0.19 | 0.30 | .007 | .012 |
| b1 | 0.19 | 0.25 | .007 | .010 |
| c | 0.090 | 0.20 | .0035 | .008 |
| c1 | 0.090 | 0.135 | .0035 | .0053 |
| D | SEE VARIATIONS | SEE VARIATIONS | SEE VARIATIONS | SEE VARIATIONS |
| E | 4.30 | 4.50 | .169 | .177 |
| e | 0.65 BSC | | .026 BSC | |
| H | 6.25 | 6.50 | .246 | .256 |
| L | 0.50 | 0.70 | .020 | .028 |
| N | SEE VARIATIONS | SEE VARIATIONS | SEE VARIATIONS | SEE VARIATIONS |
| Y | 2.85 | 3.15 | .112 | .124 |
| ⊘ | 0° | 8° | 0° | 8° |

| JEDEC | MD-153 | N | VARIATIONS | | | |
|-------|--------|---|-------------|------|--------|------|
| | | | MILLIMETERS | | INCHES | |
| | | | MIN. | MAX. | MIN. | MAX. |
| AB | 14 | D | 4.90 | 5.10 | .193 | .201 |
| AC | 16 | D | 4.90 | 5.10 | .193 | .201 |
| AC-EP | 16 | D | 4.90 | 5.10 | .193 | .201 |
| | | X | 2.85 | 3.15 | .112 | .124 |
| AD | 20 | D | 6.40 | 6.60 | .252 | .260 |
| AD-EP | 20 | D | 6.40 | 6.60 | .252 | .260 |
| | | X | 4.00 | 4.34 | .157 | .171 |
| AE | 24 | D | 7.70 | 7.90 | .303 | .311 |
| AF | 28 | D | 9.60 | 9.80 | .378 | .386 |
| AF-EP | 28 | D | 9.60 | 9.80 | .378 | .386 |
| | | X | 5.35 | 5.65 | .211 | .222 |

- NOTES:
1. DIMENSIONS D AND E DO NOT INCLUDE FLASH.
 2. MOLD FLASH OR PROTRUSIONS NOT TO EXCEED .15 mm PER SIDE.
 3. CONTROLLING DIMENSION: MILLIMETER.
 4. MEETS JEDEC OUTLINE MD-153 VARIATIONS AB, AC, AD, AE, AF.
 5. DIMENSIONS X AND Y APPLY TO EXPOSED PAD (EP) VERSIONS ONLY.
 6. EXPOSED PAD FLUSH WITH BOTTOM OF PACKAGE WITHIN .002".

MAXIM

PROPRIETARY INFORMATION

TITLE:
PACKAGE OUTLINE, TSSOP, 4.40mm BODY, 0.65mm PITCH

| | | | |
|----------|----------------------|-----|-----|
| APPROVAL | DOCUMENT CONTROL NO. | REV | |
| | 21-0066 | C | 1/1 |

Adjustable, High-Linearity, SiGe Dual-Band LNA/Mixer ICs

NOTES

Компания «Океан Электроники» предлагает заключение долгосрочных отношений при поставках импортных электронных компонентов на взаимовыгодных условиях!

Наши преимущества:

- Поставка оригинальных импортных электронных компонентов напрямую с производств Америки, Европы и Азии, а так же с крупнейших складов мира;
- Широкая линейка поставок активных и пассивных импортных электронных компонентов (более 30 млн. наименований);
- Поставка сложных, дефицитных, либо снятых с производства позиций;
- Оперативные сроки поставки под заказ (от 5 рабочих дней);
- Экспресс доставка в любую точку России;
- Помощь Конструкторского Отдела и консультации квалифицированных инженеров;
- Техническая поддержка проекта, помощь в подборе аналогов, поставка прототипов;
- Поставка электронных компонентов под контролем ВП;
- Система менеджмента качества сертифицирована по Международному стандарту ISO 9001;
- При необходимости вся продукция военного и аэрокосмического назначения проходит испытания и сертификацию в лаборатории (по согласованию с заказчиком);
- Поставка специализированных компонентов военного и аэрокосмического уровня качества (Xilinx, Altera, Analog Devices, Intersil, Interpoint, Microsemi, Actel, Aeroflex, Peregrine, VPT, Syfer, Eurofarad, Texas Instruments, MS Kennedy, Miteq, Cobham, E2V, MA-COM, Hittite, Mini-Circuits, General Dynamics и др.);

Компания «Океан Электроники» является официальным дистрибьютором и эксклюзивным представителем в России одного из крупнейших производителей разъемов военного и аэрокосмического назначения «JONHON», а так же официальным дистрибьютором и эксклюзивным представителем в России производителя высокотехнологичных и надежных решений для передачи СВЧ сигналов «FORSTAR».



JONHON

«JONHON» (основан в 1970 г.)

Разъемы специального, военного и аэрокосмического назначения:

(Применяются в военной, авиационной, аэрокосмической, морской, железнодорожной, горно- и нефтедобывающей отраслях промышленности)

«FORSTAR» (основан в 1998 г.)

ВЧ соединители, коаксиальные кабели,
кабельные сборки и микроволновые компоненты:

(Применяются в телекоммуникациях гражданского и специального назначения, в средствах связи, РЛС, а так же военной, авиационной и аэрокосмической отраслях промышленности).



Телефон: 8 (812) 309-75-97 (многоканальный)

Факс: 8 (812) 320-03-32

Электронная почта: ocean@oceanchips.ru

Web: <http://oceanchips.ru/>

Адрес: 198099, г. Санкт-Петербург, ул. Калинина, д. 2, корп. 4, лит. А