



Altech is pleased to announce a new, more extensive printed circuit board terminal block line. This line offers the standard single and double level fixed and pluggable terminal blocks in metric and US pin spacings. However, this product line goes beyond our past standard offering. There is now a wider array of products within each pin spacing as well as new types of blocks such as 35°, reverse horizontal wire entry, and triple level fixed blocks, card edge connectors, panel feed through blocks, barrier strips, and plugs/headers with screw flanges. This product assortment combined with the new pricing structure makes this line extremely competitive.

Altech printed circuit board terminal blocks give you highly dependable connections without the need for wire lugs. Choose either tubular screw clamps or box clamps when economy is paramount or screw-cage clamps for heavy-duty applications. In each case, simply strip and insert the wire and tighten the screw. We recommend the use of ferrules, especially for export applications and whenever fine stranded wires must be terminated.

Our board mounted terminal blocks meet or exceed most international standards and are accepted worldwide. They're available in single, double and triple level configurations with both, millimeter and inch pin spacings. All leave mini footprints to save valuable real estate.

PRINTED CIRCUIT BOARD TERMINAL BLOCKS

FIXED

Our printed circuit board terminal blocks designed for fixed mounting offer high density, and maximum flexibility. Modular construction simplifies ordering and reduces inventory. Two- and 3-pole modules can be interlocked to create multipole assemblies. Altech can also supply ready-made assemblies tailored to your specification. Fixed-mount blocks are available with the economical tubular screw, box clamp or the screw-cage clamp and offer several wire entry options to facilitate wiring and increase accessibility.

PLUGGABLE

The two-piece, plug and header design of our “pluggable” terminal blocks speed and simplify board replacement and reduce costly downtime and misconnections. No special tools are required. Headers are soldered into the board and accept the plugs, which are easily removed for fast, convenient board or device replacement. Choose single- mold designs for maximum strength. Or choose modular designs which are assembled from 2 and 3 pole modules when you need maximum flexibility to meet changing requirements. Both are available in a variety of configurations. Headers are available in vertical, and horizontal, single or double-level, with closed or open ends.

We offer pluggables with either screw-cage clamp termination for heavy duty requirements or with tubular screw termination and open headers for cost sensitive applications. We also offer a card edge connector for a quick, reliable and inexpensive connection.

CONNECTION

Altech's printed circuit board terminal blocks give you a choice between tubular screw, box clamp and screw-cage clamp designs:

- When your application calls for the highest reliability and frequent wire terminations, the screw-cage clamp should be your choice. As the clamp is tightened, the nickel-plated cage rises, pressing the wire firmly against the busbar, ensuring solid connections every time. Standard color is green.
- In the tubular screw and box clamp design, tightening the screw presses the conductor directly against the bottom of the clamp. These systems are ideal for cost sensitive, lighter duty applications or applications with infrequent wire terminations. Wire protectors are standard. Standard color is black for tubular screw and green for box clamp.

PIN SPACING

Each clamp style is offered in metric and inch pin spacing. For your convenience, this catalog is organized by pin spacing. Fixed blocks are first, starting with the smallest pin spacing, then pluggable shown in each available spacing.

MATERIALS

All of our printed circuit board terminal blocks feature precision formed or machined metal parts which are electrolytically plated. Nickel or tin-plated brass cage clamps or tubes, wire protectors, and tin-plated solder pins satisfy the most demanding requirements. Housings are precision-molded from self-extinguishing polyamid 6.8 or glass-filled polyester providing excellent strength and temperature resistance.

MARKING

Altech offers marking to identify terminal inputs. Order Hot Stamp Imprinting for permanent marking of large quantities or custom marked terminals. Standard marking is consecutive numbers, left to right. This standard marking can be ordered by adding the imprint sequence to the part number as a suffix (i.e. MV-4612/1-12 would be a MV-4612 terminal block imprinted 1 through 12, left to right).

Custom imprints are also available, consult Altech for ordering information.



Pluggable PCB Blocks

Pin Spacing: 5.00mm*
 Orientation: Horizontal Plug
 Clamp Type: Tubular Screw
 with Wire Protector
 Design: Modular



SHS-5.00

ELECTRICAL

| | Current | Voltage | Wire Range |
|--|---------|---------|------------|
| | 10A | 250V | 22-16AWG |

INSTALLATION DATA

| Screw Size | M2.6 | PCB Hole Size | – |
|------------|------------------------|-----------------|-------|
| Torque | 0.5Nm (4.5 lbf-in.) | Stripping Lgth. | 6.0mm |

MATERIAL

| | | | |
|---------------------------|------------------------|-----------------------|------------------|
| Body | Glass-Filled Polyester | Screw | Galvanized Steel |
| Flammability Class | UL94V-0 | Terminal | Cu-Be |
| Temperature Limit | 120°C | Wire Protector | Tin-Plated Brass |
| Color | Black | | |

| No. Poles | Cat. # | Length (B) (mm) | Std. Pk. |
|-----------|------------|-----------------|----------|
| 2 | SHS02-5.00 | 10.0 | 100 |
| 3 | SHS03-5.00 | 15.0 | 100 |
| 4 | SHS04-5.00 | 20.0 | 50 |
| 5 | SHS05-5.00 | 25.0 | 50 |
| 6 | SHS06-5.00 | 30.0 | 50 |
| 7 | SHS07-5.00 | 35.0 | 50 |
| 8 | SHS08-5.00 | 40.0 | 50 |
| 9 | SHS09-5.00 | 45.0 | 50 |
| 10 | SHS10-5.00 | 50.0 | 50 |
| 11 | SHS11-5.00 | 55.0 | 50 |
| 12 | SHS12-5.00 | 60.0 | 50 |
| 13 | SHS13-5.00 | 65.0 | 20 |
| 14 | SHS14-5.00 | 70.0 | 20 |
| 15 | SHS15-5.00 | 75.0 | 20 |
| 16 | SHS16-5.00 | 80.0 | 20 |
| 17 | SHS17-5.00 | 85.0 | 20 |
| 18 | SHS18-5.00 | 90.0 | 20 |
| 19 | SHS19-5.00 | 95.0 | 20 |
| 20 | SHS20-5.00 | 100.0 | 20 |
| 21 | SHS21-5.00 | 105.0 | 20 |
| 22 | SHS22-5.00 | 110.0 | 20 |
| 23 | SHS23-5.00 | 115.0 | 20 |
| 24 | SHS24-5.00 | 120.0 | 20 |



Dimensions

| | | | |
|---|----------|---|----------|
| A | 10.80 mm | I | – |
| B | 10.00 mm | J | Ø2.70 mm |
| C | 13.50 mm | K | Ø3.60 mm |
| D | 4.70 mm | L | – |
| E | – | M | – |
| F | – | N | – |
| G | 9.30 mm | O | 1.10 mm |
| H | – | P | 5.00 mm |

* Also available in 10.00mm pin spacing

Pin Spacing: 5.00mm*
 Orientation: Vertical-Pin Header
 Clamp Type: –
 Design: Breakaway



PVS-5.00

ELECTRICAL

| | Current | Voltage | Wire Range |
|--|---------|---------|------------|
| | 10A | 250V | – |

INSTALLATION DATA

| Screw Size | – | PCB Hole Size | 1.5mm |
|------------|---|-----------------|-------|
| Torque | – | Stripping Lgth. | – |

MATERIAL

| | | | |
|---------------------------|---------|-----------------|------------------|
| Body | PA6.8 | Screw | – |
| Flammability Class | UL94V-0 | Terminal | Tin-Plated Brass |
| Temperature Limit | 125°C | Clamp | – |
| Color | Black | | |

| No. Poles | Cat. # | Length (B) (mm)* | Std. Pk. |
|-----------|------------|------------------|----------|
| 2 | PVS02-5.00 | 10.0 | 100 |
| 3 | PVS03-5.00 | 15.0 | 100 |
| 4 | PVS04-5.00 | 20.0 | 50 |
| 5 | PVS05-5.00 | 25.0 | 50 |
| 6 | PVS06-5.00 | 30.0 | 50 |
| 7 | PVS07-5.00 | 35.0 | 50 |
| 8 | PVS08-5.00 | 40.0 | 50 |
| 9 | PVS09-5.00 | 45.0 | 50 |
| 10 | PVS10-5.00 | 50.0 | 50 |
| 11 | PVS11-5.00 | 55.0 | 50 |
| 12 | PVS12-5.00 | 60.0 | 50 |
| 13 | PVS13-5.00 | 65.0 | 20 |
| 14 | PVS14-5.00 | 70.0 | 20 |
| 15 | PVS15-5.00 | 75.0 | 20 |
| 16 | PVS16-5.00 | 80.0 | 20 |
| 17 | PVS17-5.00 | 85.0 | 20 |
| 18 | PVS18-5.00 | 90.0 | 20 |
| 19 | PVS19-5.00 | 95.0 | 20 |
| 20 | PVS20-5.00 | 100.0 | 20 |
| 21 | PVS21-5.00 | 105.0 | 20 |
| 22 | PVS22-5.00 | 110.0 | 20 |
| 23 | PVS23-5.00 | 115.0 | 20 |
| 24 | PVS24-5.00 | 120.0 | 20 |

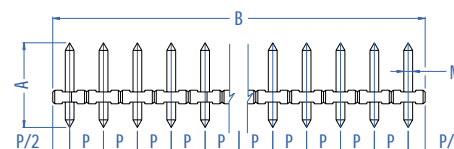

Dimensions

| | | | |
|---|------------|---|----------|
| A | 12.50 mm | I | 2.80 mm |
| B | * 10.00 mm | J | 2.00 mm |
| C | 7.00 mm | K | – |
| D | – | L | – |
| E | – | M | Ø1.30 mm |
| F | – | N | – |
| G | 3.50 mm | O | – |
| H | – | P | 5.00 mm |

* Also available in 10.00mm pin spacing

Pluggable PCB Blocks



Pin Spacing: 5.00mm
 Orientation: Horizontal Plug
 Clamp Type: Screw Cage
 Design: Single Mold

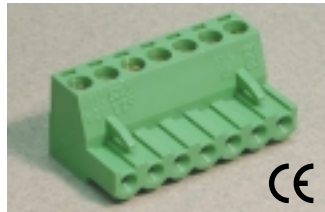

SH-5.00

ELECTRICAL

| | Current | Voltage | Wire Range |
|--|---------|---------|---|
| | 12A | 300V | 30-14AWG |
| | 16A | 450V | 2.5mm ² Stranded 4.0mm ² Solid |

INSTALLATION DATA

| | | | |
|-------------------|------------------------|------------------------|-------|
| Screw Size | M3 | PCB Hole Size | – |
| Torque | 0.5Nm (4.5 lbf-in.) | Stripping Lgth. | 7.5mm |

MATERIAL

| | | | |
|---------------------------|-----------------------|-----------------|------------------|
| Body | PA6.8 | Screw | Galvanized Steel |
| Flammability Class | UL94V-0 | Terminal | Nickeled Brass |
| Temperature Limit | 105°C UL 125°C IEC | Clamp | Nickeled Brass |
| Color | Green | | |

| No. Poles | Cat. # | Length (B) (mm)* | Std. Pk. |
|-----------|-----------|------------------|----------|
| 2 | SH02-5.00 | 10.0 | 100 |
| 3 | SH03-5.00 | 15.0 | 100 |
| 4 | SH04-5.00 | 20.0 | 50 |
| 5 | SH05-5.00 | 25.0 | 50 |
| 6 | SH06-5.00 | 30.0 | 50 |
| 7 | SH07-5.00 | 35.0 | 50 |
| 8 | SH08-5.00 | 40.0 | 50 |
| 9 | SH09-5.00 | 45.0 | 50 |
| 10 | SH10-5.00 | 50.0 | 50 |
| 11 | SH11-5.00 | 55.0 | 50 |
| 12 | SH12-5.00 | 60.0 | 50 |
| 13 | SH13-5.00 | 65.0 | 20 |
| 14 | SH14-5.00 | 70.0 | 20 |
| 15 | SH15-5.00 | 75.0 | 20 |
| 16 | SH16-5.00 | 80.0 | 20 |
| 17 | SH17-5.00 | 85.0 | 20 |
| 18 | SH18-5.00 | 90.0 | 20 |
| 19 | SH19-5.00 | 95.0 | 20 |
| 20 | SH20-5.00 | 100.0 | 20 |
| 21 | SH21-5.00 | 105.0 | 20 |
| 22 | SH22-5.00 | 110.0 | 20 |
| 23 | SH23-5.00 | 115.0 | 20 |
| 24 | SH24-5.00 | 120.0 | 20 |



Dimensions

| | | | |
|---|----------|---|---------|
| A | 15.50 mm | I | 2.80 mm |
| B | * | J | 3.10 mm |
| C | 19.15 mm | K | – |
| D | 8.30 mm | L | – |
| E | – | M | – |
| F | – | N | – |
| G | – | O | 2.70 mm |
| H | 3.80 mm | P | 5.00 mm |

Pin Spacing: 5.00mm
 Orientation: Vertical Header
 Clamp Type: –
 Design: Single Mold-Open End

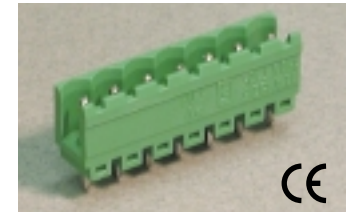

PV-5.00

ELECTRICAL

| | Current | Voltage | Wire Range |
|--|---------|---------|------------|
| | 12A | 300V | – |
| | 16A | 450V | – |

INSTALLATION DATA

| | | | |
|-------------------|---|------------------------|-------|
| Screw Size | – | PCB Hole Size | 1.5mm |
| Torque | – | Stripping Lgth. | – |

MATERIAL

| | | | |
|---------------------------|-----------------------|-----------------|------------------|
| Body | PA6.8 | Screw | – |
| Flammability Class | UL94V-0 | Terminal | Tin-Plated Brass |
| Temperature Limit | 105°C UL 125°C IEC | Clamp | – |
| Color | Green | | |

| No. Poles | Cat. # | Length (B) (mm)* | Std. Pk. |
|-----------|-----------|------------------|----------|
| 2 | PV02-5.00 | 10.0 | 100 |
| 3 | PV03-5.00 | 15.0 | 100 |
| 4 | PV04-5.00 | 20.0 | 50 |
| 5 | PV05-5.00 | 25.0 | 50 |
| 6 | PV06-5.00 | 30.0 | 50 |
| 7 | PV07-5.00 | 35.0 | 50 |
| 8 | PV08-5.00 | 40.0 | 50 |
| 9 | PV09-5.00 | 45.0 | 50 |
| 10 | PV10-5.00 | 50.0 | 50 |
| 11 | PV11-5.00 | 55.0 | 50 |
| 12 | PV12-5.00 | 60.0 | 50 |
| 13 | PV13-5.00 | 65.0 | 20 |
| 14 | PV14-5.00 | 70.0 | 20 |
| 15 | PV15-5.00 | 75.0 | 20 |
| 16 | PV16-5.00 | 80.0 | 20 |
| 17 | PV17-5.00 | 85.0 | 20 |
| 18 | PV18-5.00 | 90.0 | 20 |
| 19 | PV19-5.00 | 95.0 | 20 |
| 20 | PV20-5.00 | 100.0 | 20 |
| 21 | PV21-5.00 | 105.0 | 20 |
| 22 | PV22-5.00 | 110.0 | 20 |
| 23 | PV23-5.00 | 115.0 | 20 |
| 24 | PV24-5.00 | 120.0 | 20 |

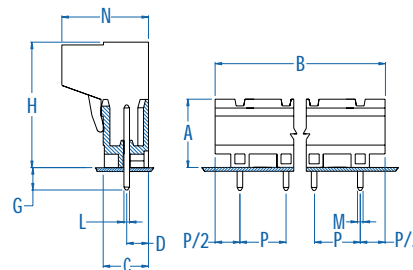

Dimensions

| | | | |
|---|----------|---|----------|
| A | 12.20 mm | I | – |
| B | * | J | – |
| C | 8.10 mm | K | – |
| D | 4.00 mm | L | 1.00 mm |
| E | – | M | 1.00 mm |
| F | – | N | 15.50 mm |
| G | 4.00 mm | O | – |
| H | 23.15 mm | P | 5.00 mm |

Pluggable PCB Blocks

Pin Spacing: 5.00mm
 Orientation: Vertical Header
 Clamp Type: –
 Design: Single Mold - Closed End



PVP-5.00

ELECTRICAL

| | Current | Voltage | Wire Range |
|--|---------|---------|------------|
| | 12A | 300V | – |
| | 16A | 450V | – |

INSTALLATION DATA

| | | | |
|------------|---|-----------------|-------|
| Screw Size | – | PCB Hole Size | 1.5mm |
| Torque | – | Stripping Lgth. | – |

MATERIAL

| | | | |
|--------------------|-----------------------|----------|------------------|
| Body | PA6.8 | Screw | – |
| Flammability Class | UL94V-0 | Terminal | Tin-Plated Brass |
| Temperature Limit | 105°C UL 125°C IEC | Clamp | – |
| Color | Green | | |

| No. Poles | Cat. # | Length (B) (mm)* | Std. Pk. |
|-----------|------------|------------------|----------|
| 2 | PVP02-5.00 | 12.0 | 100 |
| 3 | PVP03-5.00 | 17.0 | 100 |
| 4 | PVP04-5.00 | 22.0 | 50 |
| 5 | PVP05-5.00 | 27.0 | 50 |
| 6 | PVP06-5.00 | 32.0 | 50 |
| 7 | PVP07-5.00 | 37.0 | 50 |
| 8 | PVP08-5.00 | 42.0 | 50 |
| 9 | PVP09-5.00 | 47.0 | 50 |
| 10 | PVP10-5.00 | 52.0 | 50 |
| 11 | PVP11-5.00 | 57.0 | 50 |
| 12 | PVP12-5.00 | 62.0 | 50 |
| 13 | PVP13-5.00 | 67.0 | 20 |
| 14 | PVP14-5.00 | 72.0 | 20 |
| 15 | PVP15-5.00 | 77.0 | 20 |
| 16 | PVP16-5.00 | 82.0 | 20 |
| 17 | PVP17-5.00 | 87.0 | 20 |
| 18 | PVP18-5.00 | 92.0 | 20 |
| 19 | PVP19-5.00 | 97.0 | 20 |
| 20 | PVP20-5.00 | 102.0 | 20 |
| 21 | PVP21-5.00 | 107.0 | 20 |
| 22 | PVP22-5.00 | 112.0 | 20 |
| 23 | PVP23-5.00 | 117.0 | 20 |
| 24 | PVP24-5.00 | 122.0 | 20 |



Dimensions

| | | | |
|---|----------|---|----------|
| A | 12.20 mm | I | – |
| B | * | J | – |
| C | 8.10 mm | K | – |
| D | 4.00 mm | L | 1.00 mm |
| E | – | M | 1.00 mm |
| F | – | N | 15.50 mm |
| G | 4.00 mm | O | – |
| H | 23.15 mm | P | 5.00 mm |

Pin Spacing: 5.00mm
 Orientation: Horizontal Header
 Clamp Type: –
 Design: Single Mold - Open End



PH-5.00

ELECTRICAL

| | Current | Voltage | Wire Range |
|--|---------|---------|------------|
| | 12A | 300V | – |
| | 16A | 450V | – |

INSTALLATION DATA

| | | | |
|------------|---|-----------------|-------|
| Screw Size | – | PCB Hole Size | 1.5mm |
| Torque | – | Stripping Lgth. | – |

MATERIAL

| | | | |
|--------------------|-----------------------|----------|------------------|
| Body | PA6.8 | Screw | – |
| Flammability Class | UL94V-0 | Terminal | Tin-Plated Brass |
| Temperature Limit | 105°C UL 125°C IEC | Clamp | – |
| Color | Green | | |

| No. Poles | Cat. # | Length (B) (mm)* | Std. Pk. |
|-----------|-----------|------------------|----------|
| 2 | PH02-5.00 | 10.0 | 100 |
| 3 | PH03-5.00 | 15.0 | 100 |
| 4 | PH04-5.00 | 20.0 | 50 |
| 5 | PH05-5.00 | 25.0 | 50 |
| 6 | PH06-5.00 | 30.0 | 50 |
| 7 | PH07-5.00 | 35.0 | 50 |
| 8 | PH08-5.00 | 40.0 | 50 |
| 9 | PH09-5.00 | 45.0 | 50 |
| 10 | PH10-5.00 | 50.0 | 50 |
| 11 | PH11-5.00 | 55.0 | 50 |
| 12 | PH12-5.00 | 60.0 | 50 |
| 13 | PH13-5.00 | 65.0 | 20 |
| 14 | PH14-5.00 | 70.0 | 20 |
| 15 | PH15-5.00 | 75.0 | 20 |
| 16 | PH16-5.00 | 80.0 | 20 |
| 17 | PH17-5.00 | 85.0 | 20 |
| 18 | PH18-5.00 | 90.0 | 20 |
| 19 | PH19-5.00 | 95.0 | 20 |
| 20 | PH20-5.00 | 100.0 | 20 |
| 21 | PH21-5.00 | 105.0 | 20 |
| 22 | PH22-5.00 | 110.0 | 20 |
| 23 | PH23-5.00 | 115.0 | 20 |
| 24 | PH24-5.00 | 120.0 | 20 |



Dimensions

| | | | |
|---|----------|---|----------|
| A | 12.20 mm | I | – |
| B | * | J | – |
| C | 8.10 mm | K | – |
| D | 1.90 mm | L | 1.00 mm |
| E | – | M | 1.00 mm |
| F | – | N | 15.50 mm |
| G | 4.00 mm | O | – |
| H | 23.15 mm | P | 5.00 mm |

Pluggable PCB Blocks



Pin Spacing: 5.00mm
 Orientation: Horizontal Header
 Clamp Type: –
 Design: Single Mold - Closed End



PHP-5.00

ELECTRICAL

| | Current | Voltage | Wire Range |
|--|---------|---------|------------|
| | 12A | 300V | – |
| | 16A | 450V | – |

INSTALLATION DATA

| | | | |
|-------------------|---|------------------------|-------|
| Screw Size | – | PCB Hole Size | 1.5mm |
| Torque | – | Stripping Lgth. | – |

MATERIAL

| | | | |
|---------------------------|-----------------------|-----------------|------------------|
| Body | PA6.8 | Screw | – |
| Flammability Class | UL94V-0 | Terminal | Tin-Plated Brass |
| Temperature Limit | 105°C UL 125°C IEC | Clamp | – |
| Color | Green | | |

| No. Poles | Cat. # | Length (B) (mm)* | Std. Pk. |
|-----------|------------|------------------|----------|
| 2 | PHP02-5.00 | 12.0 | 100 |
| 3 | PHP03-5.00 | 17.0 | 100 |
| 4 | PHP04-5.00 | 22.0 | 50 |
| 5 | PHP05-5.00 | 27.0 | 50 |
| 6 | PHP06-5.00 | 32.0 | 50 |
| 7 | PHP07-5.00 | 37.0 | 50 |
| 8 | PHP08-5.00 | 42.0 | 50 |
| 9 | PHP09-5.00 | 47.0 | 50 |
| 10 | PHP10-5.00 | 52.0 | 50 |
| 11 | PHP11-5.00 | 57.0 | 50 |
| 12 | PHP12-5.00 | 62.0 | 50 |
| 13 | PHP13-5.00 | 67.0 | 20 |
| 14 | PHP14-5.00 | 72.0 | 20 |
| 15 | PHP15-5.00 | 77.0 | 20 |
| 16 | PHP16-5.00 | 82.0 | 20 |
| 17 | PHP17-5.00 | 87.0 | 20 |
| 18 | PHP18-5.00 | 92.0 | 20 |
| 19 | PHP19-5.00 | 97.0 | 20 |
| 20 | PHP20-5.00 | 102.0 | 20 |
| 21 | PHP21-5.00 | 107.0 | 20 |
| 22 | PHP22-5.00 | 112.0 | 20 |
| 23 | PHP23-5.00 | 117.0 | 20 |
| 24 | PHP24-5.00 | 122.0 | 20 |



Dimensions

| | | | |
|---|----------|---|----------|
| A | 12.20 mm | I | – |
| B | * | J | – |
| C | 8.10 mm | K | – |
| D | 1.90 mm | L | 1.00 mm |
| E | – | M | 1.00 mm |
| F | – | N | 15.50 mm |
| G | 4.00 mm | O | – |
| H | 23.15 mm | P | 5.00 mm |

Pin Spacing: 5.08mm
 Orientation: Horizontal Plug
 Clamp Type: Screw Cage
 Design: Single Mold



SH-5.08

ELECTRICAL

| | Current | Voltage | Wire Range |
|--|---------|---------|---|
| | 12A | 300V | 30-14AWG |
| | 16A | 450V | 2.5mm ² Stranded 4.0mm ² Solid |

INSTALLATION DATA

| | | | |
|-------------------|------------------------|------------------------|-------|
| Screw Size | M3 | PCB Hole Size | – |
| Torque | 0.5Nm (4.5 lbf-in.) | Stripping Lgth. | 7.5mm |

MATERIAL

| | | | |
|---------------------------|-----------------------|-----------------|------------------|
| Body | PA6.8 | Screw | Galvanized Steel |
| Flammability Class | UL94V-0 | Terminal | Nickel Brass |
| Temperature Limit | 105°C UL 125°C IEC | Clamp | Nickel Brass |
| Color | Green | | |

| No. Poles | Cat. # | Length (B) (mm)* | Std. Pk. |
|-----------|-----------|------------------|----------|
| 2 | SH02-5.08 | 10.2 | 100 |
| 3 | SH03-5.08 | 15.2 | 100 |
| 4 | SH04-5.08 | 20.3 | 50 |
| 5 | SH05-5.08 | 25.4 | 50 |
| 6 | SH06-5.08 | 30.5 | 50 |
| 7 | SH07-5.08 | 35.6 | 50 |
| 8 | SH08-5.08 | 40.6 | 50 |
| 9 | SH09-5.08 | 45.7 | 50 |
| 10 | SH10-5.08 | 50.8 | 50 |
| 11 | SH11-5.08 | 55.9 | 50 |
| 12 | SH12-5.08 | 61.0 | 50 |
| 13 | SH13-5.08 | 66.0 | 20 |
| 14 | SH14-5.08 | 71.1 | 20 |
| 15 | SH15-5.08 | 76.2 | 20 |
| 16 | SH16-5.08 | 81.3 | 20 |
| 17 | SH17-5.08 | 86.4 | 20 |
| 18 | SH18-5.08 | 91.4 | 20 |
| 19 | SH19-5.08 | 96.5 | 20 |
| 20 | SH20-5.08 | 101.6 | 20 |
| 21 | SH21-5.08 | 106.7 | 20 |
| 22 | SH22-5.08 | 111.8 | 20 |
| 23 | SH23-5.08 | 116.6 | 20 |
| 24 | SH24-5.08 | 121.9 | 20 |



Dimensions

| | | | |
|---|----------|---|----------|
| A | 15.50 mm | I | 2.80 mm |
| B | * | J | 3.10 mm |
| C | 18.80 mm | K | Ø1.80 mm |
| D | 8.30 mm | L | – |
| E | 1.00 mm | M | – |
| F | 5.70 mm | N | – |
| G | – | O | 2.70 mm |
| H | Ø3.80 mm | P | 5.08 mm |

Pluggable PCB Blocks

Pin Spacing: 5.08mm
 Orientation: Vertical Plug-Wire Entry on Locking Tab Side
 Clamp Type: Screw Cage
 Design: Single Mold



SVF-5.08

ELECTRICAL

| | Current | Voltage | Wire Range |
|--|---------|---------|---|
| | 12A | 300V | 30-14AWG |
| | 16A | 450V | 2.5mm ² Stranded 4.0mm ² Solid |

INSTALLATION DATA

| | | | |
|-------------------|------------------------|------------------------|-------|
| Screw Size | M3 | PCB Hole Size | – |
| Torque | 0.5Nm (4.5 lbf-in.) | Stripping Lgth. | 9.1mm |

MATERIAL

| | | | |
|---------------------------|-----------------------|-----------------|------------------|
| Body | PA6.8 | Screw | Galvanized Steel |
| Flammability Class | UL94V-0 | Terminal | Nickel Brass |
| Temperature Limit | 105°C UL 125°C IEC | Clamp | Nickel Brass |
| Color | Green | | |

| No. Poles | Cat. # | Length (B) (mm)* | Std. Pk. |
|-----------|------------|------------------|----------|
| 2 | SVF02-5.08 | 10.2 | 100 |
| 3 | SVF03-5.08 | 15.2 | 100 |
| 4 | SVF04-5.08 | 20.3 | 50 |
| 5 | SVF05-5.08 | 25.4 | 50 |
| 6 | SVF06-5.08 | 30.5 | 50 |
| 7 | SVF07-5.08 | 35.6 | 50 |
| 8 | SVF08-5.08 | 40.6 | 50 |
| 9 | SVF09-5.08 | 45.7 | 50 |
| 10 | SVF10-5.08 | 50.8 | 50 |
| 11 | SVF11-5.08 | 55.9 | 50 |
| 12 | SVF12-5.08 | 61.0 | 50 |
| 13 | SVF13-5.08 | 66.0 | 20 |
| 14 | SVF14-5.08 | 71.1 | 20 |
| 15 | SVF15-5.08 | 76.2 | 20 |
| 16 | SVF16-5.08 | 81.3 | 20 |
| 17 | SVF17-5.08 | 86.4 | 20 |
| 18 | SVF18-5.08 | 91.4 | 20 |
| 19 | SVF19-5.08 | 96.5 | 20 |
| 20 | SVF20-5.08 | 101.6 | 20 |
| 21 | SVF21-5.08 | 106.7 | 20 |
| 22 | SVF22-5.08 | 111.8 | 20 |
| 23 | SVF23-5.08 | 116.6 | 20 |
| 24 | SVF24-5.08 | 121.9 | 20 |

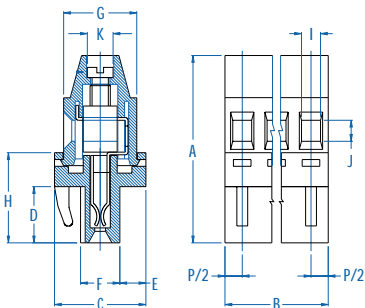

Dimensions

| | | | |
|---|----------|---|----------|
| A | 27.60 mm | I | 2.80 mm |
| B | * | J | 3.10 mm |
| C | 13.50 mm | K | Ø3.80 mm |
| D | 8.30 mm | L | – |
| E | 3.85 mm | M | – |
| F | 5.80 mm | N | – |
| G | 10.80 mm | O | – |
| H | 13.30 mm | P | 5.08 mm |

Pin Spacing: 5.08mm
 Orientation: Vertical Plug-Wire Entry on Scalloped Side
 Clamp Type: Screw Cage
 Design: Single Mold



SVP-5.08

ELECTRICAL

| | Current | Voltage | Wire Range |
|--|---------|---------|---|
| | 12A | 300V | 30-14AWG |
| | 16A | 450V | 2.5mm ² Stranded 4.0mm ² Solid |

INSTALLATION DATA

| | | | |
|-------------------|------------------------|------------------------|-------|
| Screw Size | M3 | PCB Hole Size | – |
| Torque | 0.5Nm (4.5 lbf-in.) | Stripping Lgth. | 9.1mm |

MATERIAL

| | | | |
|---------------------------|-----------------------|-----------------|------------------|
| Body | PA6.8 | Screw | Galvanized Steel |
| Flammability Class | UL94V-0 | Terminal | Nickel Brass |
| Temperature Limit | 105°C UL 125°C IEC | Clamp | Nickel Brass |
| Color | Green | | |

| No. Poles | Cat. # | Length (B) (mm)* | Std. Pk. |
|-----------|------------|------------------|----------|
| 2 | SVP02-5.08 | 10.2 | 100 |
| 3 | SVP03-5.08 | 15.2 | 100 |
| 4 | SVP04-5.08 | 20.3 | 50 |
| 5 | SVP05-5.08 | 25.4 | 50 |
| 6 | SVP06-5.08 | 30.5 | 50 |
| 7 | SVP07-5.08 | 35.6 | 50 |
| 8 | SVP08-5.08 | 40.6 | 50 |
| 9 | SVP09-5.08 | 45.7 | 50 |
| 10 | SVP10-5.08 | 50.8 | 50 |
| 11 | SVP11-5.08 | 55.9 | 50 |
| 12 | SVP12-5.08 | 61.0 | 50 |
| 13 | SVP13-5.08 | 66.0 | 20 |
| 14 | SVP14-5.08 | 71.1 | 20 |
| 15 | SVP15-5.08 | 76.2 | 20 |
| 16 | SVP16-5.08 | 81.3 | 20 |
| 17 | SVP17-5.08 | 86.4 | 20 |
| 18 | SVP18-5.08 | 91.4 | 20 |
| 19 | SVP19-5.08 | 96.5 | 20 |
| 20 | SVP20-5.08 | 101.6 | 20 |
| 21 | SVP21-5.08 | 106.7 | 20 |
| 22 | SVP22-5.08 | 111.8 | 20 |
| 23 | SVP23-5.08 | 116.6 | 20 |
| 24 | SVP24-5.08 | 121.9 | 20 |

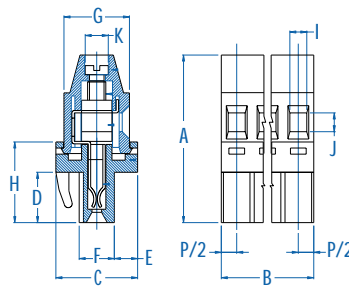

Dimensions

| | | | |
|---|----------|---|----------|
| A | 27.60 mm | I | 2.80 mm |
| B | * | J | 3.10 mm |
| C | 13.50 mm | K | Ø3.80 mm |
| D | 8.30 mm | L | – |
| E | 3.85 mm | M | – |
| F | 5.80 mm | N | – |
| G | 10.80 mm | O | – |
| H | 13.30 mm | P | 5.08 mm |

Pin Spacing: 5.08mm
 Orientation: Vertical Header
 Clamp Type: –
 Design: Single Mold-Open End

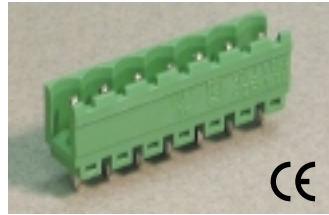

PV-5.08

ELECTRICAL

| | Current | Voltage | Wire Range |
|--|---------|---------|------------|
| | 12A | 300V | – |
| | 16A | 450V | – |

INSTALLATION DATA

| | | | |
|------------|---|-----------------|-------|
| Screw Size | – | PCB Hole Size | 1.5mm |
| Torque | – | Stripping Lgth. | – |

MATERIAL

| | | | |
|--------------------|-----------------------|----------|------------------|
| Body | PA6.8 | Screw | – |
| Flammability Class | UL94V-0 | Terminal | Tin-Plated Brass |
| Temperature Limit | 105°C UL 125°C IEC | Clamp | – |
| Color | Green | | |

| No. Poles | Cat. # | Length (B) (mm)* | Std. Pk. |
|-----------|-----------|------------------|----------|
| 2 | PV02-5.08 | 10.2 | 100 |
| 3 | PV03-5.08 | 15.2 | 100 |
| 4 | PV04-5.08 | 20.3 | 50 |
| 5 | PV05-5.08 | 25.4 | 50 |
| 6 | PV06-5.08 | 30.5 | 50 |
| 7 | PV07-5.08 | 35.6 | 50 |
| 8 | PV08-5.08 | 40.6 | 50 |
| 9 | PV09-5.08 | 45.7 | 50 |
| 10 | PV10-5.08 | 50.8 | 50 |
| 11 | PV11-5.08 | 55.9 | 50 |
| 12 | PV12-5.08 | 61.0 | 50 |
| 13 | PV13-5.08 | 66.0 | 20 |
| 14 | PV14-5.08 | 71.1 | 20 |
| 15 | PV15-5.08 | 76.2 | 20 |
| 16 | PV16-5.08 | 81.3 | 20 |
| 17 | PV17-5.08 | 86.4 | 20 |
| 18 | PV18-5.08 | 91.4 | 20 |
| 19 | PV19-5.08 | 96.5 | 20 |
| 20 | PV20-5.08 | 101.6 | 20 |
| 21 | PV21-5.08 | 106.7 | 20 |
| 22 | PV22-5.08 | 111.8 | 20 |
| 23 | PV23-5.08 | 116.6 | 20 |
| 24 | PV24-5.08 | 121.9 | 20 |

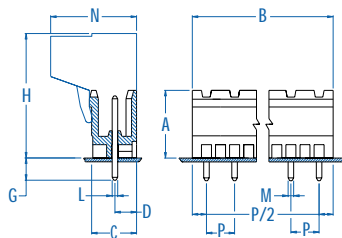

Dimensions

| | | | |
|---|----------|---|----------|
| A | 12.20 mm | I | – |
| B | * | J | – |
| C | 8.10 mm | K | – |
| D | 4.00 mm | L | 1.00 mm |
| E | – | M | 1.00 mm |
| F | – | N | 15.50 mm |
| G | 4.00 mm | O | – |
| H | 22.80 mm | P | 5.08 mm |

Pin Spacing: 5.08mm
 Orientation: Vertical Header
 Clamp Type: –
 Design: Single Mold - Closed End

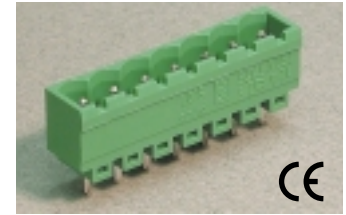

PVP-5.08

ELECTRICAL

| | Current | Voltage | Wire Range |
|--|---------|---------|------------|
| | 12A | 300V | – |
| | 16A | 450V | – |

INSTALLATION DATA

| | | | |
|------------|---|-----------------|-------|
| Screw Size | – | PCB Hole Size | 1.5mm |
| Torque | – | Stripping Lgth. | – |

MATERIAL

| | | | |
|--------------------|-----------------------|----------|------------------|
| Body | PA6.8 | Screw | – |
| Flammability Class | UL94V-0 | Terminal | Tin-Plated Brass |
| Temperature Limit | 105°C UL 125°C IEC | Clamp | – |
| Color | Green | | |

| No. Poles | Cat. # | Length (B) (mm)* | Std. Pk. |
|-----------|------------|------------------|----------|
| 2 | PVP02-5.08 | 12.2 | 100 |
| 3 | PVP03-5.08 | 17.2 | 100 |
| 4 | PVP04-5.08 | 22.3 | 50 |
| 5 | PVP05-5.08 | 27.4 | 50 |
| 6 | PVP06-5.08 | 32.5 | 50 |
| 7 | PVP07-5.08 | 37.6 | 50 |
| 8 | PVP08-5.08 | 42.6 | 50 |
| 9 | PVP09-5.08 | 47.7 | 50 |
| 10 | PVP10-5.08 | 52.8 | 50 |
| 11 | PVP11-5.08 | 57.9 | 50 |
| 12 | PVP12-5.08 | 63.0 | 50 |
| 13 | PVP13-5.08 | 68.0 | 20 |
| 14 | PVP14-5.08 | 73.1 | 20 |
| 15 | PVP15-5.08 | 78.2 | 20 |
| 16 | PVP16-5.08 | 83.3 | 20 |
| 17 | PVP17-5.08 | 88.4 | 20 |
| 18 | PVP18-5.08 | 93.4 | 20 |
| 19 | PVP19-5.08 | 98.5 | 20 |
| 20 | PVP20-5.08 | 103.6 | 20 |
| 21 | PVP21-5.08 | 108.7 | 20 |
| 22 | PVP22-5.08 | 113.8 | 20 |
| 23 | PVP23-5.08 | 118.6 | 20 |
| 24 | PVP24-5.08 | 123.9 | 20 |

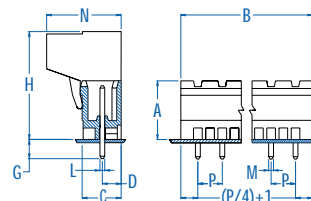

Dimensions

| | | | |
|---|----------|---|----------|
| A | 12.20 mm | I | – |
| B | * | J | – |
| C | 8.10 mm | K | – |
| D | 4.00 mm | L | 1.00 mm |
| E | – | M | 1.00 mm |
| F | – | N | 15.50 mm |
| G | 4.00 mm | O | – |
| H | 22.80 mm | P | 5.08 mm |

Pluggable PCB Blocks

Pin Spacing: 5.08mm
 Orientation: Horizontal Header
 Clamp Type: -
 Design: Single Mold - Open End

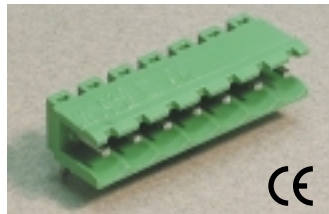

PH-5.08

ELECTRICAL

| | Current | Voltage | Wire Range |
|--|---------|---------|------------|
| | 12A | 300V | - |
| | 16A | 450V | - |

INSTALLATION DATA

| | | | |
|------------|---|-----------------|-------|
| Screw Size | - | PCB Hole Size | 1.5mm |
| Torque | - | Stripping Lgth. | - |

MATERIAL

| | | | |
|--------------------|-----------------------|----------|------------------|
| Body | PA6.8 | Screw | - |
| Flammability Class | UL94V-0 | Terminal | Tin-Plated Brass |
| Temperature Limit | 105°C UL 125°C IEC | Clamp | - |
| Color | Green | | |

| No. Poles | Cat. # | Length (B) (mm)* | Std. Pk. |
|-----------|-----------|------------------|----------|
| 2 | PH02-5.08 | 10.2 | 100 |
| 3 | PH03-5.08 | 15.2 | 100 |
| 4 | PH04-5.08 | 20.3 | 50 |
| 5 | PH05-5.08 | 25.4 | 50 |
| 6 | PH06-5.08 | 30.5 | 50 |
| 7 | PH07-5.08 | 35.6 | 50 |
| 8 | PH08-5.08 | 40.6 | 50 |
| 9 | PH09-5.08 | 45.7 | 50 |
| 10 | PH10-5.08 | 50.8 | 50 |
| 11 | PH11-5.08 | 55.9 | 50 |
| 12 | PH12-5.08 | 61.0 | 50 |
| 13 | PH13-5.08 | 66.0 | 20 |
| 14 | PH14-5.08 | 71.1 | 20 |
| 15 | PH15-5.08 | 76.2 | 20 |
| 16 | PH16-5.08 | 81.3 | 20 |
| 17 | PH17-5.08 | 86.4 | 20 |
| 18 | PH18-5.08 | 91.4 | 20 |
| 19 | PH19-5.08 | 96.5 | 20 |
| 20 | PH20-5.08 | 101.6 | 20 |
| 21 | PH21-5.08 | 106.7 | 20 |
| 22 | PH22-5.08 | 111.8 | 20 |
| 23 | PH23-5.08 | 116.6 | 20 |
| 24 | PH24-5.08 | 121.9 | 20 |



Dimensions

| | | | |
|---|----------|---|----------|
| A | 12.20 mm | I | - |
| B | * | J | - |
| C | 8.10 mm | K | - |
| D | 1.90 mm | L | 1.00 mm |
| E | - | M | 1.00 mm |
| F | - | N | 15.50 mm |
| G | 4.00 mm | O | - |
| H | 22.80 mm | P | 5.08 mm |

Pin Spacing: 5.08mm
 Orientation: Horizontal Header
 Clamp Type: -
 Design: Single Mold - Closed End

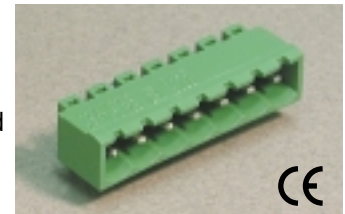

PHP-5.08

ELECTRICAL

| | Current | Voltage | Wire Range |
|--|---------|---------|------------|
| | 12A | 300V | - |
| | 16A | 450V | - |

INSTALLATION DATA

| | | | |
|------------|---|-----------------|-------|
| Screw Size | - | PCB Hole Size | 1.5mm |
| Torque | - | Stripping Lgth. | - |

MATERIAL

| | | | |
|--------------------|-----------------------|----------|------------------|
| Body | PA6.8 | Screw | - |
| Flammability Class | UL94V-0 | Terminal | Tin-Plated Brass |
| Temperature Limit | 105°C UL 125°C IEC | Clamp | - |
| Color | Green | | |

| No. Poles | Cat. # | Length (B) (mm)* | Std. Pk. |
|-----------|------------|------------------|----------|
| 2 | PHP02-5.08 | 12.2 | 100 |
| 3 | PHP03-5.08 | 17.2 | 100 |
| 4 | PHP04-5.08 | 22.3 | 50 |
| 5 | PHP05-5.08 | 27.4 | 50 |
| 6 | PHP06-5.08 | 32.5 | 50 |
| 7 | PHP07-5.08 | 37.6 | 50 |
| 8 | PHP08-5.08 | 42.6 | 50 |
| 9 | PHP09-5.08 | 47.7 | 50 |
| 10 | PHP10-5.08 | 52.8 | 50 |
| 11 | PHP11-5.08 | 57.9 | 50 |
| 12 | PHP12-5.08 | 63.0 | 50 |
| 13 | PHP13-5.08 | 68.0 | 20 |
| 14 | PHP14-5.08 | 73.1 | 20 |
| 15 | PHP15-5.08 | 78.2 | 20 |
| 16 | PHP16-5.08 | 83.3 | 20 |
| 17 | PHP17-5.08 | 88.4 | 20 |
| 18 | PHP18-5.08 | 93.4 | 20 |
| 19 | PHP19-5.08 | 98.5 | 20 |
| 20 | PHP20-5.08 | 103.6 | 20 |
| 21 | PHP21-5.08 | 108.7 | 20 |
| 22 | PHP22-5.08 | 113.8 | 20 |
| 23 | PHP23-5.08 | 118.6 | 20 |
| 24 | PHP24-5.08 | 123.9 | 20 |



Dimensions

| | | | |
|---|----------|---|----------|
| A | 12.20 mm | I | - |
| B | * | J | - |
| C | 8.10 mm | K | - |
| D | 1.90 mm | L | 1.00 mm |
| E | - | M | 1.00 mm |
| F | - | N | 15.50 mm |
| G | 4.00 mm | O | - |
| H | 22.80 mm | P | 5.08 mm |

Pin Spacing: 5.08mm
 Orientation: Vertical -
 Double Level Header
 Clamp Type: -
 Design: Modular - Open End



PDSV-5.08

ELECTRICAL

| | Current | Voltage | Wire Range |
|--|---------|---------|------------|
| | 12A | 300V | - |
| | 16A | 450V | - |

INSTALLATION DATA

| | | | |
|------------|---|-----------------|-------|
| Screw Size | - | PCB Hole Size | 1.5mm |
| Torque | - | Stripping Lgth. | - |

MATERIAL

| | | | |
|--------------------|-----------------------|----------|------------------|
| Body | PA6.8 | Screw | - |
| Flammability Class | UL94V-0 | Terminal | Tin-Plated Brass |
| Temperature Limit | 105°C UL 125°C IEC | Clamp | - |
| Color | Green | | |

| No. Poles | Cat. # | Length (B) (mm)* | Std. Pk. |
|-----------|-------------|------------------|----------|
| 4 | PDSV02-5.08 | 10.2 | 100 |
| 6 | PDSV03-5.08 | 15.2 | 100 |
| 8 | PDSV04-5.08 | 20.3 | 50 |
| 10 | PDSV05-5.08 | 25.4 | 50 |
| 12 | PDSV06-5.08 | 30.5 | 50 |
| 14 | PDSV07-5.08 | 35.6 | 50 |
| 16 | PDSV08-5.08 | 40.6 | 50 |
| 18 | PDSV09-5.08 | 45.7 | 50 |
| 20 | PDSV10-5.08 | 50.8 | 50 |
| 22 | PDSV11-5.08 | 55.9 | 20 |
| 24 | PDSV12-5.08 | 61.0 | 20 |
| 26 | PDSV13-5.08 | 66.0 | 20 |
| 28 | PDSV14-5.08 | 71.1 | 20 |
| 30 | PDSV15-5.08 | 76.2 | 20 |
| 32 | PDSV16-5.08 | 81.3 | 20 |
| 34 | PDSV17-5.08 | 86.4 | 20 |
| 36 | PDSV18-5.08 | 91.4 | 20 |
| 38 | PDSV19-5.08 | 96.5 | 20 |
| 40 | PDSV20-5.08 | 101.6 | 10 |
| 42 | PDSV21-5.08 | 106.7 | 10 |
| 44 | PDSV22-5.08 | 111.8 | 10 |
| 46 | PDSV23-5.08 | 116.6 | 10 |
| 48 | PDSV24-5.08 | 121.9 | 10 |



Dimensions

| | | | |
|---|----------|---|----------|
| A | 12.20 mm | I | - |
| B | * | J | - |
| C | 23.74 mm | K | - |
| D | 3.90 mm | L | 1.00 mm |
| E | 15.24 mm | M | 1.00 mm |
| F | 4.00 mm | N | 15.50 mm |
| G | 22.00 mm | O | - |
| H | 22.80 mm | P | 5.08 mm |

Pin Spacing: 5.08mm
 Orientation: Horizontal - Double
 Level Header
 Clamp Type: -
 Design: Modular - Open End



PDSH-5.08

ELECTRICAL

| | Current | Voltage | Wire Range |
|--|---------|---------|------------|
| | 12A | 300V | - |
| | 16A | 450V | - |

INSTALLATION DATA

| | | | |
|------------|---|-----------------|-------|
| Screw Size | - | PCB Hole Size | 1.5mm |
| Torque | - | Stripping Lgth. | - |

MATERIAL

| | | | |
|--------------------|-----------------------|----------|------------------|
| Body | PA6.8 | Screw | - |
| Flammability Class | UL94V-0 | Terminal | Tin-Plated Brass |
| Temperature Limit | 105°C UL 125°C IEC | Clamp | - |
| Color | Green | | |

| No. Poles | Cat. # | Length (B) (mm)* | Std. Pk. |
|-----------|-------------|------------------|----------|
| 4 | PDSH02-5.08 | 10.2 | 100 |
| 6 | PDSH03-5.08 | 15.2 | 100 |
| 8 | PDSH04-5.08 | 20.3 | 50 |
| 10 | PDSH05-5.08 | 25.4 | 50 |
| 12 | PDSH06-5.08 | 30.5 | 50 |
| 14 | PDSH07-5.08 | 35.6 | 50 |
| 16 | PDSH08-5.08 | 40.6 | 50 |
| 18 | PDSH09-5.08 | 45.7 | 50 |
| 20 | PDSH10-5.08 | 50.8 | 50 |
| 22 | PDSH11-5.08 | 55.9 | 20 |
| 24 | PDSH12-5.08 | 61.0 | 20 |
| 26 | PDSH13-5.08 | 66.0 | 20 |
| 28 | PDSH14-5.08 | 71.1 | 20 |
| 30 | PDSH15-5.08 | 76.2 | 20 |
| 32 | PDSH16-5.08 | 81.3 | 20 |
| 34 | PDSH17-5.08 | 86.4 | 20 |
| 36 | PDSH18-5.08 | 91.4 | 20 |
| 38 | PDSH19-5.08 | 96.5 | 20 |
| 40 | PDSH20-5.08 | 101.6 | 10 |
| 42 | PDSH21-5.08 | 106.7 | 10 |
| 44 | PDSH22-5.08 | 111.8 | 10 |
| 46 | PDSH23-5.08 | 116.6 | 10 |
| 48 | PDSH24-5.08 | 121.9 | 10 |



Dimensions

| | | | |
|---|----------|---|----------|
| A | 12.20 mm | I | - |
| B | * | J | - |
| C | 23.74 mm | K | - |
| D | 1.90 mm | L | 1.00 mm |
| E | 10.00 mm | M | 1.00 mm |
| F | 4.00 mm | N | 15.50 mm |
| G | 22.00 mm | O | - |
| H | 22.80 mm | P | 5.08 mm |

Pluggable PCB Blocks

Pin Spacing: 5.08mm
 Orientation: Horizontal Plug with
 Screw Flange
 Clamp Type: Screw Cage
 Design: Single Mold

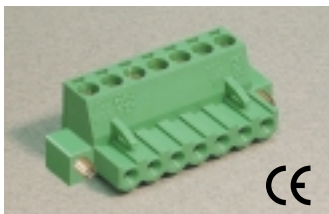

SH-5.08-K

ELECTRICAL

| | Current | Voltage | Wire Range |
|--|---------|---------|---|
| | 12A | 300V | 30-14AWG |
| | 16A | 500V | 2.5mm ² Stranded 4.0mm ² Solid |

INSTALLATION DATA

| | | | |
|-------------------|-----------------------|------------------------|-------|
| Screw Size | M3 | PCB Hole Size | – |
| Torque | 0.5Nm (4.5 lbf-in) | Stripping Lgth. | 7.5mm |

MATERIAL

| | | | |
|---------------------------|-----------------------|-----------------|------------------|
| Body | PA6.8 | Screw | Galvanized Steel |
| Flammability Class | UL94V-0 | Terminal | Nickeled Brass |
| Temperature Limit | 105°C UL 125°C IEC | Clamp | Nickeled Brass |
| Color | Green | | |

| No. Poles | Cat. # | Length (B) (mm)* | Std. Pk. |
|-----------|---------------|------------------|----------|
| 2 | SH02-5.08 - K | 20.3 | 100 |
| 3 | SH03-5.08 - K | 25.4 | 100 |
| 4 | SH04-5.08 - K | 30.5 | 50 |
| 5 | SH05-5.08 - K | 35.6 | 50 |
| 6 | SH06-5.08 - K | 40.6 | 50 |
| 7 | SH07-5.08 - K | 45.7 | 50 |
| 8 | SH08-5.08 - K | 50.8 | 50 |
| 9 | SH09-5.08 - K | 55.9 | 50 |
| 10 | SH10-5.08 - K | 61.0 | 50 |
| 11 | SH11-5.08 - K | 66.0 | 50 |
| 12 | SH12-5.08 - K | 71.1 | 50 |
| 13 | SH13-5.08 - K | 76.2 | 20 |
| 14 | SH14-5.08 - K | 81.3 | 20 |
| 15 | SH15-5.08 - K | 86.4 | 20 |
| 16 | SH16-5.08 - K | 91.4 | 20 |
| 17 | SH17-5.08 - K | 96.5 | 20 |
| 18 | SH18-5.08 - K | 101.6 | 20 |
| 19 | SH19-5.08 - K | 106.7 | 20 |
| 20 | SH20-5.08 - K | 111.8 | 20 |
| 21 | SH21-5.08 - K | 116.6 | 20 |
| 22 | SH22-5.08 - K | 121.9 | 20 |

Pin Spacing: 5.08mm
 Orientation: Vertical Header with
 Screw Flange
 Clamp Type: –
 Design: Single Mold

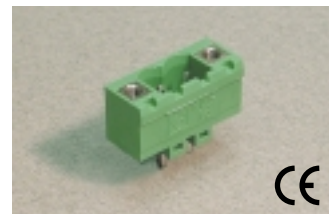

PV-5.08-K

ELECTRICAL

| | Current | Voltage | Wire Range |
|--|---------|---------|------------|
| | 12A | 300V | – |
| | 16A | 450V | – |

INSTALLATION DATA

| | | | |
|-------------------|---|------------------------|-------|
| Screw Size | – | PCB Hole Size | 1.5mm |
| Torque | – | Stripping Lgth. | – |

MATERIAL

| | | | |
|---------------------------|-----------------------|-----------------|------------------|
| Body | PA6.8 | Screw | – |
| Flammability Class | UL94V-0 | Terminal | Tin-Plated Brass |
| Temperature Limit | 105°C UL 125°C IEC | Clamp | Nickeled Brass |
| Color | Green | | |

| No. Poles | Cat. # | Length (B) (mm)* | Std. Pk. |
|-----------|---------------|------------------|----------|
| 2 | PV02-5.08 - K | 20.3 | 100 |
| 3 | PV03-5.08 - K | 25.4 | 100 |
| 4 | PV04-5.08 - K | 30.5 | 50 |
| 5 | PV05-5.08 - K | 35.6 | 50 |
| 6 | PV06-5.08 - K | 40.6 | 50 |
| 7 | PV07-5.08 - K | 45.7 | 50 |
| 8 | PV08-5.08 - K | 50.8 | 50 |
| 9 | PV09-5.08 - K | 55.9 | 50 |
| 10 | PV10-5.08 - K | 61.0 | 50 |
| 11 | PV11-5.08 - K | 66.0 | 50 |
| 12 | PV12-5.08 - K | 71.1 | 50 |
| 13 | PV13-5.08 - K | 76.2 | 20 |
| 14 | PV14-5.08 - K | 81.3 | 20 |
| 15 | PV15-5.08 - K | 86.4 | 20 |
| 16 | PV16-5.08 - K | 91.4 | 20 |
| 17 | PV17-5.08 - K | 96.5 | 20 |
| 18 | PV18-5.08 - K | 101.6 | 20 |
| 19 | PV19-5.08 - K | 106.7 | 20 |
| 20 | PV20-5.08 - K | 111.8 | 20 |
| 21 | PV21-5.08 - K | 116.6 | 20 |
| 22 | PV22-5.08 - K | 121.9 | 20 |

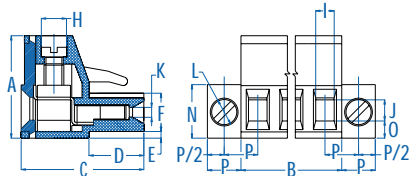

Dimensions

| | | | |
|---|----------|---|----------|
| A | 15.50 mm | I | 2.80 mm |
| B | * | J | 3.10 mm |
| C | 18.80 mm | K | Ø1.80 mm |
| D | 8.30 mm | L | Ø3.80 mm |
| E | 1.00 mm | M | – |
| F | 5.70 mm | N | 8.10 mm |
| G | – | O | 2.70 mm |
| H | Ø3.80 mm | P | 5.08 mm |

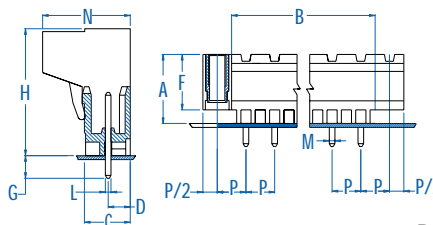

Dimensions

| | | | |
|---|----------|---|----------|
| A | 12.20 mm | I | – |
| B | * | J | – |
| C | 8.10 mm | K | – |
| D | 4.00 mm | L | 1.00 mm |
| E | – | M | 1.00 mm |
| F | 9.80 mm | N | 15.50 mm |
| G | 4.00 mm | O | – |
| H | 22.80 mm | P | 5.08 mm |

Pluggable PCB Blocks



Pin Spacing: 5.08mm
 Orientation: Horizontal Header with Screw Flange
 Clamp Type: –
 Design: Single Mold

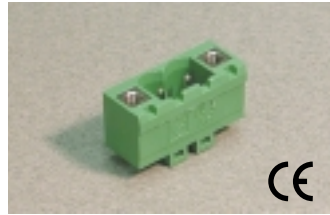

PH-5.08-K

ELECTRICAL

| | Current | Voltage | Wire Range |
|--|---------|---------|------------|
| | 12A | 300V | – |
| | 16A | 450V | – |

INSTALLATION DATA

| | | | |
|-------------------|---|------------------------|-------|
| Screw Size | – | PCB Hole Size | 1.5mm |
| Torque | – | Stripping Lgth. | – |

MATERIAL

| | | | |
|---------------------------|-----------------------|-----------------|------------------|
| Body | PA6.8 | Screw | – |
| Flammability Class | UL94V-0 | Terminal | Tin-Plated Brass |
| Temperature Limit | 105°C UL 125°C IEC | Clamp | Nickeled Brass |
| Color | Green | | |

| No. Poles | Cat. # | Length (B) (mm)* | Std. Pk. |
|-----------|---------------|------------------|----------|
| 2 | PH02-5.08 - K | 20.3 | 100 |
| 3 | PH03-5.08 - K | 25.4 | 100 |
| 4 | PH04-5.08 - K | 30.5 | 50 |
| 5 | PH05-5.08 - K | 35.6 | 50 |
| 6 | PH06-5.08 - K | 40.6 | 50 |
| 7 | PH07-5.08 - K | 45.7 | 50 |
| 8 | PH08-5.08 - K | 50.8 | 50 |
| 9 | PH09-5.08 - K | 55.9 | 50 |
| 10 | PH10-5.08 - K | 61.0 | 50 |
| 11 | PH11-5.08 - K | 66.0 | 50 |
| 12 | PH12-5.08 - K | 71.1 | 50 |
| 13 | PH13-5.08 - K | 76.2 | 20 |
| 14 | PH14-5.08 - K | 81.3 | 20 |
| 15 | PH15-5.08 - K | 86.4 | 20 |
| 16 | PH16-5.08 - K | 91.4 | 20 |
| 17 | PH17-5.08 - K | 96.5 | 20 |
| 18 | PH18-5.08 - K | 101.6 | 20 |
| 19 | PH19-5.08 - K | 106.7 | 20 |
| 20 | PH20-5.08 - K | 111.8 | 20 |
| 21 | PH21-5.08 - K | 116.6 | 20 |
| 22 | PH22-5.08 - K | 121.9 | 20 |

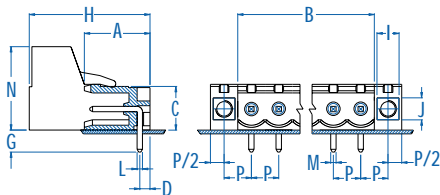

Dimensions

| | | | |
|---|----------|---|----------|
| A | 12.20 mm | I | 4.10 mm |
| B | * | J | 4.10 mm |
| C | 8.10 mm | K | – |
| D | 1.90 mm | L | 1.00 mm |
| E | – | M | 1.00 mm |
| F | – | N | 15.50 mm |
| G | 4.00 mm | O | – |
| H | 22.80 mm | P | 5.08 mm |

Pin Spacing: 6.35mm
 Orientation: Vertical Plug
 Clamp Type: Screw Cage
 Design: Modular - Card Edge

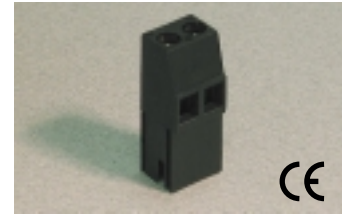

MVI

ELECTRICAL

| | Current | Voltage | Wire Range |
|--|------------------|---------|---|
| | 20A ^① | 300V | 30-12AWG |
| | 10A | 500V | 4.0mm ² Stranded 6.0mm ² Solid |

INSTALLATION DATA

| | | | |
|-------------------|------------------------|------------------------|-----------|
| Screw Size | M3 | PCB Thickness | 1.5-1.7mm |
| Torque | 0.5Nm (4.5 lbf-in.) | Stripping Lgth. | 9.8mm |

MATERIAL

| | | | |
|---------------------------|-----------------------|-----------------|------------------|
| Body | PA6.8 | Screw | Galvanized Steel |
| Flammability Class | UL94V-0 | Terminal | Nickeled Brass |
| Temperature Limit | 105°C UL 125°C IEC | Clamp | Nickeled Brass |
| Color | Black | | |

| No. Poles | Cat. # | Length (B) (mm) | Std. Pk. |
|-----------|--------|-----------------|----------|
| 2 | MVI-2 | 12.7 | 100 |
| 3 | MVI-3 | 19.0 | 100 |
| 4 | MVI-4 | 25.4 | 50 |
| 5 | MVI-5 | 31.8 | 50 |
| 6 | MVI-6 | 38.1 | 50 |
| 7 | MVI-7 | 44.5 | 50 |
| 8 | MVI-8 | 50.8 | 50 |
| 9 | MVI-9 | 57.2 | 50 |
| 10 | MVI-10 | 63.5 | 50 |
| 11 | MVI-11 | 69.9 | 50 |
| 12 | MVI-12 | 76.2 | 50 |
| 13 | MVI-13 | 82.6 | 20 |
| 14 | MVI-14 | 88.9 | 20 |
| 15 | MVI-15 | 95.3 | 20 |
| 16 | MVI-16 | 101.6 | 20 |

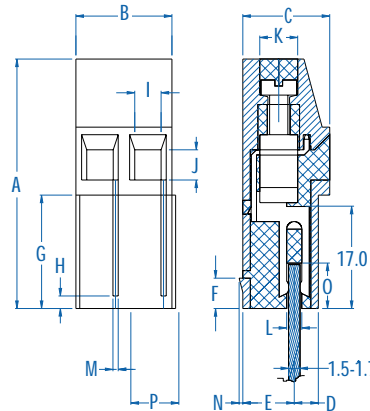

Dimensions

| | | | |
|---|----------|---|----------|
| A | 33.00 mm | I | 3.10 mm |
| B | 12.70 mm | J | 3.90 mm |
| C | 11.40 mm | K | Ø4.70 mm |
| D | 3.20 mm | L | 1.30 mm |
| E | 6.70 mm | M | 0.70 mm |
| F | 4.00 mm | N | 1.00 mm |
| G | 15.00 mm | O | 6.00 mm |
| H | 1.50 mm | P | 6.35 mm |

^① 25A Factory Wiring - UL

Pluggable PCB Blocks

Pin Spacing: 7.50mm
 Orientation: Horizontal Plug
 Clamp Type: Screw Cage
 Design: Single Mold

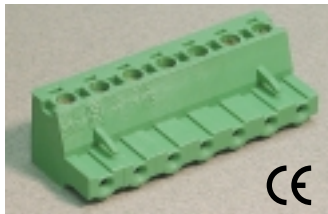

SH-7.50

ELECTRICAL

| | Current | Voltage | Wire Range |
|--|---------|---------|---|
| | 12A | 300V | 30-14AWG |
| | 16A | 750V | 2.5mm ² Stranded 4.0mm ² Solid |

INSTALLATION DATA

| | | | |
|-------------------|------------------------|------------------------|-------|
| Screw Size | M3 | PCB Hole Size | – |
| Torque | 0.5Nm (4.5 lbf-in.) | Stripping Lgth. | 7.6mm |

MATERIAL

| | | | |
|---------------------------|-----------------------|-----------------|------------------|
| Body | PA6.8 | Screw | Galvanized Steel |
| Flammability Class | UL94V-0 | Terminal | Nickeled Brass |
| Temperature Limit | 105°C UL 125°C IEC | Clamp | Nickeled Brass |
| Color | Green | | |

| No. Poles | Cat. # | Length (B) (mm)* | Std. Pk. |
|-----------|-----------|------------------|----------|
| 2 | SH02-7.50 | 15.0 | 100 |
| 3 | SH03-7.50 | 22.5 | 100 |
| 4 | SH04-7.50 | 30.0 | 50 |
| 5 | SH05-7.50 | 37.5 | 50 |
| 6 | SH06-7.50 | 45.0 | 50 |
| 7 | SH07-7.50 | 52.5 | 50 |
| 8 | SH08-7.50 | 60.0 | 50 |
| 9 | SH09-7.50 | 67.5 | 50 |
| 10 | SH10-7.50 | 75.0 | 50 |
| 11 | SH11-7.50 | 82.5 | 20 |
| 12 | SH12-7.50 | 90.0 | 20 |
| 13 | SH13-7.50 | 97.5 | 20 |
| 14 | SH14-7.50 | 105.0 | 20 |
| 15 | SH15-7.50 | 112.5 | 20 |
| 16 | SH16-7.50 | 120.0 | 20 |

Pin Spacing: 7.50mm
 Orientation: Vertical Header
 Clamp Type: –
 Design: Single Mold - Open End



PV-7.50

ELECTRICAL

| | Current | Voltage | Wire Range |
|--|---------|---------|------------|
| | 12A | 300V | – |
| | 16A | 750V | – |

INSTALLATION DATA

| | | | |
|-------------------|---|------------------------|-------|
| Screw Size | – | PCB Hole Size | 1.5mm |
| Torque | – | Stripping Lgth. | – |

MATERIAL

| | | | |
|---------------------------|-----------------------|-----------------|------------------|
| Body | PA6.8 | Screw | – |
| Flammability Class | UL94V-0 | Terminal | Tin-Plated Brass |
| Temperature Limit | 105°C UL 125°C IEC | Clamp | – |
| Color | Green | | |

| No. Poles | Cat. # | Length (B) (mm)* | Std. Pk. |
|-----------|-----------|------------------|----------|
| 2 | PV02-7.50 | 15.0 | 100 |
| 3 | PV03-7.50 | 22.5 | 100 |
| 4 | PV04-7.50 | 30.0 | 50 |
| 5 | PV05-7.50 | 37.5 | 50 |
| 6 | PV06-7.50 | 45.0 | 50 |
| 7 | PV07-7.50 | 52.5 | 50 |
| 8 | PV08-7.50 | 60.0 | 50 |
| 9 | PV09-7.50 | 67.5 | 50 |
| 10 | PV10-7.50 | 75.0 | 50 |
| 11 | PV11-7.50 | 82.5 | 20 |
| 12 | PV12-7.50 | 90.0 | 20 |
| 13 | PV13-7.50 | 97.5 | 20 |
| 14 | PV14-7.50 | 105.0 | 20 |
| 15 | PV15-7.50 | 112.5 | 20 |
| 16 | PV16-7.50 | 120.0 | 20 |

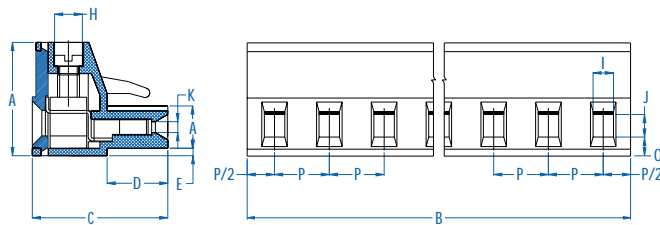

Dimensions

| | | | |
|---|----------|---|----------|
| A | 15.50 mm | I | 2.80 mm |
| B | * | J | 3.10 mm |
| C | 19.85 mm | K | Ø1.80 mm |
| D | 8.30 mm | L | – |
| E | 1.00 mm | M | – |
| F | 5.70 mm | N | – |
| G | – | O | 2.70 mm |
| H | Ø4.00 mm | P | 7.50 mm |

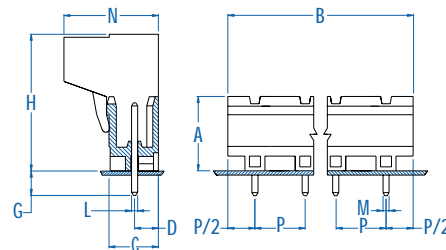

Dimensions

| | | | |
|---|----------|---|----------|
| A | 12.20 mm | I | – |
| B | * | J | – |
| C | 8.10 mm | K | – |
| D | 4.00 mm | L | 1.00 mm |
| E | – | M | 1.00 mm |
| F | – | N | 15.50 mm |
| G | 4.00 mm | O | – |
| H | 23.75 mm | P | 7.50 mm |

Pin Spacing: 7.50mm
 Orientation: Vertical Header
 Clamp Type: –
 Design: Single Mold - Closed End



PVP-7.50

ELECTRICAL

| | Current | Voltage | Wire Range |
|--|---------|---------|------------|
| | 12A | 300V | – |
| | 16A | 750V | – |

INSTALLATION DATA

| | | | |
|------------|---|-----------------|-------|
| Screw Size | – | PCB Hole Size | 1.5mm |
| Torque | – | Stripping Lgth. | – |

MATERIAL

| | | | |
|--------------------|-----------------------|----------|------------------|
| Body | PA6.8 | Screw | – |
| Flammability Class | UL94V-0 | Terminal | Tin-Plated Brass |
| Temperature Limit | 105°C UL 125°C IEC | Clamp | – |
| Color | Green | | |

| No. Poles | Cat. # | Length (B) (mm)* | Std. Pk. |
|-----------|------------|------------------|----------|
| 2 | PVP02-7.50 | 15.0 | 100 |
| 3 | PVP03-7.50 | 22.5 | 100 |
| 4 | PVP04-7.50 | 30.0 | 50 |
| 5 | PVP05-7.50 | 37.5 | 50 |
| 6 | PVP06-7.50 | 45.0 | 50 |
| 7 | PVP07-7.50 | 52.5 | 50 |
| 8 | PVP08-7.50 | 60.0 | 50 |
| 9 | PVP09-7.50 | 67.5 | 50 |
| 10 | PVP10-7.50 | 75.0 | 50 |
| 11 | PVP11-7.50 | 82.5 | 20 |
| 12 | PVP12-7.50 | 90.0 | 20 |
| 13 | PVP13-7.50 | 97.5 | 20 |
| 14 | PVP14-7.50 | 105.0 | 20 |
| 15 | PVP15-7.50 | 112.5 | 20 |
| 16 | PVP16-7.50 | 120.0 | 20 |



Dimensions

| | | | |
|---|----------|---|----------|
| A | 12.20 mm | I | – |
| B | * | J | – |
| C | 8.10 mm | K | – |
| D | 4.00 mm | L | 1.00 mm |
| E | – | M | 1.00 mm |
| F | – | N | 15.50 mm |
| G | 4.00 mm | O | – |
| H | 23.75 mm | P | 7.50 mm |

Pin Spacing: 7.50mm
 Orientation: Horizontal Header
 Clamp Type: –
 Design: Single Mold - Open End



PH-7.50

ELECTRICAL

| | Current | Voltage | Wire Range |
|--|---------|---------|------------|
| | 12A | 300V | – |
| | 16A | 750V | – |

INSTALLATION DATA

| | | | |
|------------|---|-----------------|-------|
| Screw Size | – | PCB Hole Size | 1.5mm |
| Torque | – | Stripping Lgth. | – |

MATERIAL

| | | | |
|--------------------|-----------------------|----------|------------------|
| Body | PA6.8 | Screw | – |
| Flammability Class | UL94V-0 | Terminal | Tin-Plated Brass |
| Temperature Limit | 105°C UL 125°C IEC | Clamp | – |
| Color | Green | | |

| No. Poles | Cat. # | Length (B) (mm)* | Std. Pk. |
|-----------|-----------|------------------|----------|
| 2 | PH02-7.50 | 15.0 | 100 |
| 3 | PH03-7.50 | 22.5 | 100 |
| 4 | PH04-7.50 | 30.0 | 50 |
| 5 | PH05-7.50 | 37.5 | 50 |
| 6 | PH06-7.50 | 45.0 | 50 |
| 7 | PH07-7.50 | 52.5 | 50 |
| 8 | PH08-7.50 | 60.0 | 50 |
| 9 | PH09-7.50 | 67.5 | 50 |
| 10 | PH10-7.50 | 75.0 | 50 |
| 11 | PH11-7.50 | 82.5 | 20 |
| 12 | PH12-7.50 | 90.0 | 20 |
| 13 | PH13-7.50 | 97.5 | 20 |
| 14 | PH14-7.50 | 105.0 | 20 |
| 15 | PH15-7.50 | 112.5 | 20 |
| 16 | PH16-7.50 | 120.0 | 20 |



Dimensions

| | | | |
|---|----------|---|----------|
| A | 12.20 mm | I | – |
| B | * | J | – |
| C | 8.10 mm | K | – |
| D | 1.90 mm | L | 1.00 mm |
| E | – | M | 1.00 mm |
| F | – | N | 15.50 mm |
| G | 4.00 mm | O | – |
| H | 23.75 mm | P | 7.50 mm |

Pluggable PCB Blocks

Pin Spacing: 7.50mm
 Orientation: Horizontal Header
 Clamp Type: –
 Design: Single Mold - Closed End



PHP-7.50

ELECTRICAL

| | Current | Voltage | Wire Range |
|--|---------|---------|------------|
| | 12A | 300V | – |
| | 16A | 750V | – |

INSTALLATION DATA

| | | | |
|------------|---|-----------------|-------|
| Screw Size | – | PCB Hole Size | 1.5mm |
| Torque | – | Stripping Lgth. | – |

MATERIAL

| | | | |
|--------------------|-----------------------|----------|------------------|
| Body | PA6.8 | Screw | – |
| Flammability Class | UL94V-0 | Terminal | Tin-Plated Brass |
| Temperature Limit | 105°C UL 125°C IEC | Clamp | – |
| Color | Green | | |

| No. Poles | Cat. # | Length (B) (mm)* | Std. Pk. |
|-----------|------------|------------------|----------|
| 2 | PHP02-7.50 | 15.0 | 100 |
| 3 | PHP03-7.50 | 22.5 | 100 |
| 4 | PHP04-7.50 | 30.0 | 50 |
| 5 | PHP05-7.50 | 37.5 | 50 |
| 6 | PHP06-7.50 | 45.0 | 50 |
| 7 | PHP07-7.50 | 52.5 | 50 |
| 8 | PHP08-7.50 | 60.0 | 50 |
| 9 | PHP09-7.50 | 67.5 | 50 |
| 10 | PHP10-7.50 | 75.0 | 50 |
| 11 | PHP11-7.50 | 82.5 | 20 |
| 12 | PHP12-7.50 | 90.0 | 20 |
| 13 | PHP13-7.50 | 97.5 | 20 |
| 14 | PHP14-7.50 | 105.0 | 20 |
| 15 | PHP15-7.50 | 112.5 | 20 |
| 16 | PHP16-7.50 | 120.0 | 20 |

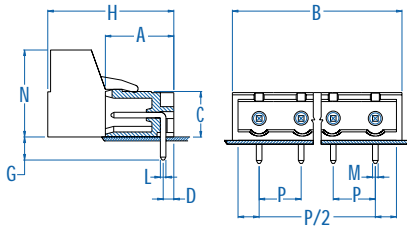

Dimensions

| | | | |
|---|----------|---|----------|
| A | 12.20 mm | I | – |
| B | * | J | – |
| C | 8.10 mm | K | – |
| D | 1.90 mm | L | 1.00 mm |
| E | – | M | 1.00 mm |
| F | – | N | 15.50 mm |
| G | 4.00 mm | O | – |
| H | 23.75 mm | P | 7.50 mm |

Pin Spacing: 10.00mm
 Orientation: Horizontal Plug
 Clamp Type: Screw Cage
 Design: Single Mold



SH-10.00

ELECTRICAL

| | Current | Voltage | Wire Range |
|--|---------|---------|---------------------------------|
| | 12A | 300V | 30-14AWG |
| | 16A | 750V | 2.5mm² Stranded 4.0mm² Solid |

INSTALLATION DATA

| | | | |
|------------|------------------------|-----------------|-------|
| Screw Size | M3 | PCB Hole Size | – |
| Torque | 0.5Nm (4.5 lbf-in.) | Stripping Lgth. | 7.5mm |

MATERIAL

| | | | |
|--------------------|-----------------------|----------|------------------|
| Body | PA6.8 | Screw | Galvanized Steel |
| Flammability Class | UL94V-0 | Terminal | Nickeled Brass |
| Temperature Limit | 105°C UL 125°C IEC | Clamp | Nickeled Brass |
| Color | Green | | |

| No. Poles | Cat. # | Length (B) (mm)* | Std. Pk. |
|-----------|------------|------------------|----------|
| 2 | SH02-10.00 | 15.0 | 100 |
| 3 | SH03-10.00 | 25.0 | 100 |
| 4 | SH04-10.00 | 35.0 | 50 |
| 5 | SH05-10.00 | 45.0 | 50 |
| 6 | SH06-10.00 | 55.0 | 50 |
| 7 | SH07-10.00 | 65.0 | 50 |
| 8 | SH08-10.00 | 75.0 | 50 |
| 9 | SH09-10.00 | 85.0 | 50 |
| 10 | SH10-10.00 | 95.0 | 50 |
| 11 | SH11-10.00 | 105.0 | 20 |
| 12 | SH12-10.00 | 115.0 | 20 |



Dimensions

| | | | |
|---|----------|---|----------|
| A | 15.50 mm | I | 2.80 mm |
| B | * | J | 3.10 mm |
| C | 19.15 mm | K | – |
| D | 8.30 mm | L | – |
| E | – | M | – |
| F | – | N | – |
| G | – | O | 2.70 mm |
| H | Ø3.80 mm | P | 10.00 mm |

Pluggable PCB Blocks



Pin Spacing: 10.00mm
 Orientation: Vertical Header
 Clamp Type: –
 Design: Single Mold - Open End



PV-10.00

ELECTRICAL

| | Current | Voltage | Wire Range |
|--|---------|---------|------------|
| | 12A | 300V | – |
| | 16A | 750V | – |

INSTALLATION DATA

| | | | |
|------------|---|-----------------|-------|
| Screw Size | – | PCB Hole Size | 1.5mm |
| Torque | – | Stripping Lgth. | – |

MATERIAL

| | | | |
|--------------------|-----------------------|----------|------------------|
| Body | PA6.8 | Screw | – |
| Flammability Class | UL94V-0 | Terminal | Tin-Plated Brass |
| Temperature Limit | 105°C UL 125°C IEC | Clamp | – |
| Color | Green | | |

| No. Poles | Cat. # | Length (B) (mm)* | Std. Pk. |
|-----------|------------|------------------|----------|
| 2 | PV02-10.00 | 15.0 | 100 |
| 3 | PV03-10.00 | 25.0 | 100 |
| 4 | PV04-10.00 | 35.0 | 50 |
| 5 | PV05-10.00 | 45.0 | 50 |
| 6 | PV06-10.00 | 55.0 | 50 |
| 7 | PV07-10.00 | 65.0 | 50 |
| 8 | PV08-10.00 | 75.0 | 50 |
| 9 | PV09-10.00 | 85.0 | 50 |
| 10 | PV10-10.00 | 95.0 | 50 |
| 11 | PV11-10.00 | 105.0 | 20 |
| 12 | PV12-10.00 | 115.0 | 20 |



Dimensions

| | | | |
|---|----------|---|----------|
| A | 12.20 mm | I | – |
| B | * | J | – |
| C | 8.10 mm | K | – |
| D | 4.00 mm | L | 1.00 mm |
| E | – | M | 1.00 mm |
| F | – | N | 15.50 mm |
| G | 4.00 mm | O | – |
| H | 23.15 mm | P | 10.00 mm |

Pin Spacing: 10.00mm
 Orientation: Vertical Header
 Clamp Type: –
 Design: Single Mold - Closed End

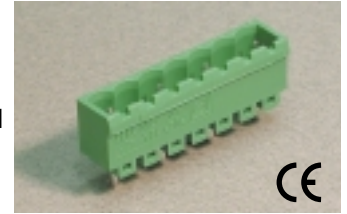

PVP-10.00

ELECTRICAL

| | Current | Voltage | Wire Range |
|--|---------|---------|------------|
| | 12A | 300V | – |
| | 16A | 750V | – |

INSTALLATION DATA

| | | | |
|------------|---|-----------------|-------|
| Screw Size | – | PCB Hole Size | 1.5mm |
| Torque | – | Stripping Lgth. | – |

MATERIAL

| | | | |
|--------------------|-----------------------|----------|------------------|
| Body | PA6.8 | Screw | – |
| Flammability Class | UL94V-0 | Terminal | Tin-Plated Brass |
| Temperature Limit | 105°C UL 125°C IEC | Clamp | – |
| Color | Green | | |

| No. Poles | Cat. # | Length (B) (mm)* | Std. Pk. |
|-----------|-------------|------------------|----------|
| 2 | PVP02-10.00 | 17.0 | 100 |
| 3 | PVP03-10.00 | 27.0 | 100 |
| 4 | PVP04-10.00 | 37.0 | 50 |
| 7 | PVP07-10.00 | 47.0 | 50 |
| 6 | PVP06-10.00 | 57.0 | 50 |
| 7 | PVP07-10.00 | 67.0 | 50 |
| 8 | PVP08-10.00 | 77.0 | 50 |
| 9 | PVP09-10.00 | 87.0 | 50 |
| 10 | PVP10-10.00 | 97.0 | 50 |
| 11 | PVP11-10.00 | 107.0 | 20 |
| 12 | PVP12-10.00 | 117.0 | 20 |



Dimensions

| | | | |
|---|----------|---|----------|
| A | 12.20 mm | I | – |
| B | * | J | – |
| C | 8.10 mm | K | – |
| D | 4.00 mm | L | 1.00 mm |
| E | – | M | 1.00 mm |
| F | – | N | 15.50 mm |
| G | 4.00 mm | O | – |
| H | 23.15 mm | P | 10.00 mm |

Pluggable PCB Blocks

Pin Spacing: 10.00mm
 Orientation: Horizontal Header
 Clamp Type: –
 Design: Single Mold - Open End



PH-10.00

ELECTRICAL

| | Current | Voltage | Wire Range |
|--|---------|---------|------------|
| | 12A | 300V | – |
| | 16A | 750V | – |

INSTALLATION DATA

| | | | |
|------------|---|-----------------|-------|
| Screw Size | – | PCB Hole Size | 1.5mm |
| Torque | – | Stripping Lgth. | – |

MATERIAL

| | | | |
|--------------------|-----------------------|----------|------------------|
| Body | PA6.8 | Screw | – |
| Flammability Class | UL94V-0 | Terminal | Tin-Plated Brass |
| Temperature Limit | 105°C UL 125°C IEC | Clamp | – |
| Color | Green | | |

| No. Poles | Cat. # | Length (B) (mm)* | Std. Pk. |
|-----------|------------|------------------|----------|
| 2 | PH02-10.00 | 15.0 | 100 |
| 3 | PH03-10.00 | 25.0 | 100 |
| 4 | PH04-10.00 | 35.0 | 50 |
| 5 | PH05-10.00 | 45.0 | 50 |
| 6 | PH06-10.00 | 55.0 | 50 |
| 5 | PH05-10.00 | 65.0 | 50 |
| 8 | PH08-10.00 | 75.0 | 50 |
| 9 | PH09-10.00 | 85.0 | 50 |
| 10 | PH10-10.00 | 95.0 | 50 |
| 11 | PH11-10.00 | 105.0 | 20 |
| 12 | PH12-10.00 | 115.0 | 20 |



Dimensions

| | | | |
|---|----------|---|----------|
| A | 12.20 mm | I | – |
| B | * | J | – |
| C | 8.10 mm | K | – |
| D | 1.90 mm | L | 1.00 mm |
| E | – | M | 1.00 mm |
| F | – | N | 15.50 mm |
| G | 4.00 mm | O | – |
| H | 23.15 mm | P | 10.00 mm |

Pin Spacing: 10.00mm
 Orientation: Horizontal Header
 Clamp Type: –
 Design: Single Mold - Closed End



PHP-10.00

ELECTRICAL

| | Current | Voltage | Wire Range |
|--|---------|---------|------------|
| | 12A | 300V | – |
| | 16A | 750V | – |

INSTALLATION DATA

| | | | |
|------------|---|-----------------|-------|
| Screw Size | – | PCB Hole Size | 1.5mm |
| Torque | – | Stripping Lgth. | – |

MATERIAL

| | | | |
|--------------------|-----------------------|----------|------------------|
| Body | PA6.8 | Screw | – |
| Flammability Class | UL94V-0 | Terminal | Tin-Plated Brass |
| Temperature Limit | 105°C UL 125°C IEC | Clamp | – |
| Color | Green | | |

| No. Poles | Cat. # | Length (B) (mm)* | Std. Pk. |
|-----------|-------------|------------------|----------|
| 2 | PHP02-10.00 | 17.0 | 100 |
| 3 | PHP03-10.00 | 27.0 | 100 |
| 4 | PHP04-10.00 | 37.0 | 50 |
| 7 | PHP07-10.00 | 47.0 | 50 |
| 6 | PHP06-10.00 | 57.0 | 50 |
| 7 | PHP07-10.00 | 67.0 | 50 |
| 8 | PHP08-10.00 | 77.0 | 50 |
| 9 | PHP09-10.00 | 87.0 | 50 |
| 10 | PHP10-10.00 | 97.0 | 50 |
| 11 | PHP11-10.00 | 107.0 | 20 |
| 12 | PHP12-10.00 | 117.0 | 20 |

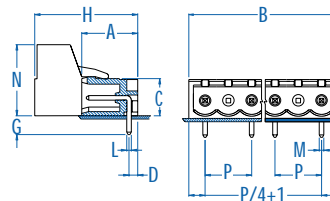

Dimensions

| | | | |
|---|----------|---|----------|
| A | 12.20 mm | I | – |
| B | * | J | – |
| C | 8.10 mm | K | – |
| D | 1.90 mm | L | 1.00 mm |
| E | – | M | 1.00 mm |
| F | – | N | 15.50 mm |
| G | 4.00 mm | O | – |
| H | 23.15 mm | P | 10.00 mm |

Pluggable PCB Blocks

Pin Spacing: 10.16mm
 Orientation: Horizontal Plug
 Clamp Type: Screw Cage
 Design: Single Mold



SH-10.16

ELECTRICAL

| | Current | Voltage | Wire Range |
|--|---------|---------|---|
| | 12A | 300V | 30-14AWG |
| | 16A | 750V | 2.5mm ² Stranded 4.0mm ² Solid |

INSTALLATION DATA

| | | | |
|-------------------|------------------------|------------------------|-------|
| Screw Size | M3 | PCB Hole Size | – |
| Torque | 0.5Nm (4.5 lbf-in.) | Stripping Lgth. | 7.5mm |

MATERIAL

| | | | |
|---------------------------|-----------------------|-----------------|------------------|
| Body | PA6.8 | Screw | Galvanized Steel |
| Flammability Class | UL94V-0 | Terminal | Nickeled Brass |
| Temperature Limit | 105°C UL 125°C IEC | Clamp | Nickeled Brass |
| Color | Green | | |

| No. Poles | Cat. # | Length (B) (mm)* | Std. Pk. |
|-----------|------------|------------------|----------|
| 2 | SH02-10.16 | 15.2 | 100 |
| 3 | SH03-10.16 | 25.4 | 100 |
| 4 | SH04-10.16 | 35.6 | 50 |
| 5 | SH05-10.16 | 45.7 | 50 |
| 6 | SH06-10.16 | 55.9 | 50 |
| 7 | SH07-10.16 | 66.0 | 50 |
| 8 | SH08-10.16 | 76.2 | 50 |
| 9 | SH09-10.16 | 86.4 | 50 |
| 10 | SH10-10.16 | 96.5 | 50 |
| 11 | SH11-10.16 | 106.7 | 20 |
| 12 | SH12-10.16 | 116.8 | 20 |



Dimensions

| | | | |
|---|----------|---|----------|
| A | 15.50 mm | I | 2.80 mm |
| B | * | J | 3.10 mm |
| C | 18.80 mm | K | Ø1.80 mm |
| D | 8.30 mm | L | – |
| E | 1.00 mm | M | – |
| F | 5.70 mm | N | – |
| G | – | O | 2.70 mm |
| H | Ø3.80 mm | P | 10.16 mm |

Pin Spacing: 10.16mm
 Orientation: Vertical Header
 Clamp Type: –
 Design: Single Mold - Open End



PV-10.16

ELECTRICAL

| | Current | Voltage | Wire Range |
|--|---------|---------|------------|
| | 12A | 300V | – |
| | 16A | 750V | – |

INSTALLATION DATA

| | | | |
|-------------------|---|------------------------|-------|
| Screw Size | – | PCB Hole Size | 1.5mm |
| Torque | – | Stripping Lgth. | – |

MATERIAL

| | | | |
|---------------------------|-----------------------|-----------------|------------------|
| Body | PA6.8 | Screw | – |
| Flammability Class | UL94V-0 | Terminal | Tin-Plated Brass |
| Temperature Limit | 105°C UL 125°C IEC | Clamp | – |
| Color | Green | | |

| No. Poles | Cat. # | Length (B) (mm)* | Std. Pk. |
|-----------|------------|------------------|----------|
| 2 | PV02-10.16 | 15.2 | 100 |
| 3 | PV03-10.16 | 25.4 | 100 |
| 4 | PV04-10.16 | 35.6 | 50 |
| 5 | PV05-10.16 | 45.7 | 50 |
| 6 | PV06-10.16 | 55.9 | 50 |
| 7 | PV07-10.16 | 66.0 | 50 |
| 8 | PV08-10.16 | 76.2 | 50 |
| 9 | PV09-10.16 | 86.4 | 50 |
| 10 | PV10-10.16 | 96.5 | 50 |
| 11 | PV11-10.16 | 106.7 | 20 |
| 12 | PV12-10.16 | 116.8 | 20 |

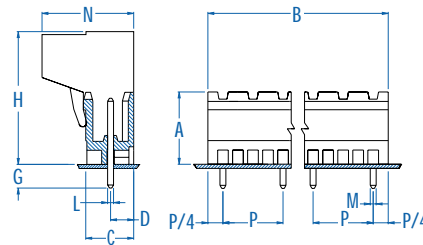

Dimensions

| | | | |
|---|----------|---|----------|
| A | 12.20 mm | I | – |
| B | * | J | – |
| C | 8.10 mm | K | – |
| D | 4.00 mm | L | 1.00 mm |
| E | – | M | 1.00 mm |
| F | – | N | 15.50 mm |
| G | 4.00 mm | O | – |
| H | 22.80 mm | P | 10.16 mm |

Pluggable PCB Blocks

Pin Spacing: 10.16mm
 Orientation: Vertical Header
 Clamp Type: –
 Design: Single Mold - Closed End



PVP-10.16

ELECTRICAL

| | Current | Voltage | Wire Range |
|--|---------|---------|------------|
| | 12A | 300V | – |
| | 16A | 750V | – |

INSTALLATION DATA

| | | | |
|-------------------|---|------------------------|-------|
| Screw Size | – | PCB Hole Size | 1.5mm |
| Torque | – | Stripping Lgth. | – |

MATERIAL

| | | | |
|---------------------------|-----------------------|-----------------|------------------|
| Body | PA6.8 | Screw | – |
| Flammability Class | UL94V-0 | Terminal | Tin-Plated Brass |
| Temperature Limit | 105°C UL 125°C IEC | Clamp | – |
| Color | Green | | |

| No. Poles | Cat. # | Length (B) (mm)* | Std. Pk. |
|-----------|-------------|------------------|----------|
| 2 | PVP02-10.16 | 17.2 | 100 |
| 3 | PVP03-10.16 | 27.4 | 100 |
| 4 | PVP04-10.16 | 37.6 | 50 |
| 5 | PVP05-10.16 | 47.7 | 50 |
| 6 | PVP06-10.16 | 57.9 | 50 |
| 7 | PVP07-10.16 | 68.0 | 50 |
| 8 | PVP08-10.16 | 78.2 | 50 |
| 9 | PVP09-10.16 | 88.4 | 50 |
| 10 | PVP10-10.16 | 98.5 | 50 |
| 11 | PVP11-10.16 | 108.7 | 20 |
| 12 | PVP12-10.16 | 118.8 | 20 |

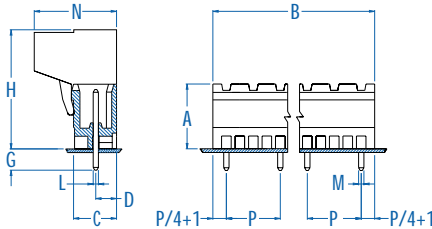

Dimensions

| | | | |
|---|----------|---|----------|
| A | 12.20 mm | I | – |
| B | * | J | – |
| C | 8.10 mm | K | – |
| D | 4.00 mm | L | 1.00 mm |
| E | – | M | 1.00 mm |
| F | – | N | 15.50 mm |
| G | 4.00 mm | O | – |
| H | 22.80 mm | P | 10.16 mm |

Pin Spacing: 10.16mm
 Orientation: Horizontal Header
 Clamp Type: –
 Design: Single Mold - Open End



PH-10.16

ELECTRICAL

| | Current | Voltage | Wire Range |
|--|---------|---------|------------|
| | 12A | 300V | – |
| | 16A | 750V | – |

INSTALLATION DATA

| | | | |
|-------------------|---|------------------------|-------|
| Screw Size | – | PCB Hole Size | 1.5mm |
| Torque | – | Stripping Lgth. | – |

MATERIAL

| | | | |
|---------------------------|-----------------------|-----------------|------------------|
| Body | PA6.8 | Screw | – |
| Flammability Class | UL94V-0 | Terminal | Tin-Plated Brass |
| Temperature Limit | 105°C UL 125°C IEC | Clamp | – |
| Color | Green | | |

| No. Poles | Cat. # | Length (B) (mm)* | Std Pk |
|-----------|------------|------------------|--------|
| 2 | PH02-10.16 | 15.2 | 100 |
| 3 | PH03-10.16 | 25.4 | 100 |
| 4 | PH04-10.16 | 35.6 | 50 |
| 5 | PH05-10.16 | 45.7 | 50 |
| 6 | PH06-10.16 | 55.9 | 50 |
| 7 | PH07-10.16 | 66.0 | 50 |
| 8 | PH08-10.16 | 76.2 | 50 |
| 9 | PH09-10.16 | 86.4 | 50 |
| 10 | PH10-10.16 | 96.5 | 50 |
| 11 | PH11-10.16 | 106.7 | 20 |
| 12 | PH12-10.16 | 116.8 | 20 |

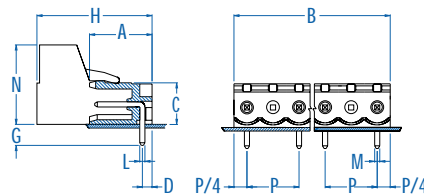

Dimensions

| | | | |
|---|----------|---|----------|
| A | 12.20 mm | I | – |
| B | * | J | – |
| C | 8.10 mm | K | – |
| D | 4.00 mm | L | 1.00 mm |
| E | – | M | 1.00 mm |
| F | – | N | 15.50 mm |
| G | 4.00 mm | O | – |
| H | 22.80 mm | P | 10.16 mm |

Pin Spacing: 10.16mm
 Orientation: Horizontal Header
 Clamp Type: –
 Design: Single Mold - Closed End



PHP-10.16

ELECTRICAL

| | Current | Voltage | Wire Range |
|--|---------|---------|------------|
| | 12A | 300V | – |
| | 16A | 750V | – |

INSTALLATION DATA

| | | | |
|------------|---|-----------------|-------|
| Screw Size | – | PCB Hole Size | 1.5mm |
| Torque | – | Stripping Lgth. | – |

MATERIAL

| | | | |
|--------------------|-----------------------|----------|------------------|
| Body | PA6.8 | Screw | – |
| Flammability Class | UL94V-0 | Terminal | Tin-Plated Brass |
| Temperature Limit | 105°C UL 125°C IEC | Clamp | – |
| Color | Green | | |

| No. Poles | Cat. # | Length (B) (mm)* | Std. Pk. |
|-----------|-------------|------------------|----------|
| 2 | PHP02-10.16 | 17.2 | 100 |
| 3 | PHP03-10.16 | 27.4 | 100 |
| 4 | PHP04-10.16 | 37.6 | 50 |
| 5 | PHP05-10.16 | 47.7 | 50 |
| 6 | PHP06-10.16 | 57.9 | 50 |
| 7 | PHP07-10.16 | 68.0 | 50 |
| 8 | PHP08-10.16 | 78.2 | 50 |
| 9 | PHP09-10.16 | 88.4 | 50 |
| 10 | PHP10-10.16 | 98.5 | 50 |
| 11 | PHP11-10.16 | 108.7 | 20 |
| 12 | PHP12-10.16 | 118.8 | 20 |

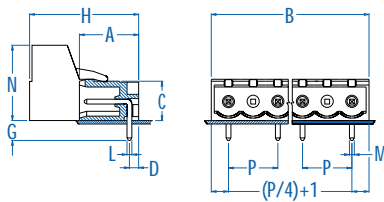

Dimensions

| | | | |
|---|----------|---|----------|
| A | 12.20 mm | I | – |
| B | * | J | – |
| C | 8.10 mm | K | – |
| D | 4.00 mm | L | 1.00 mm |
| E | – | M | 1.00 mm |
| F | – | N | 15.50 mm |
| G | 4.00 mm | O | – |
| H | 22.80 mm | P | 10.16 mm |

Pin Spacing: 10.16mm
 Orientation: Vertical-Double
 Level Header
 Clamp Type: –
 Design: Modular - Open End



PDSV-10.16

ELECTRICAL

| | Current | Voltage | Wire Range |
|--|---------|---------|------------|
| | 12A | 300V | – |
| | 16A | 750V | – |

INSTALLATION DATA

| | | | |
|------------|---|-----------------|-------|
| Screw Size | – | PCB Hole Size | 1.5mm |
| Torque | – | Stripping Lgth. | – |

MATERIAL

| | | | |
|--------------------|-----------------------|----------|------------------|
| Body | PA6.8 | Screw | – |
| Flammability Class | UL94V-0 | Terminal | Tin-Plated Brass |
| Temperature Limit | 105°C UL 125°C IEC | Clamp | – |
| Color | Green | | |

| No. Poles | Cat. # | Length (B) (mm) | Std. Pk. |
|-----------|--------------|-----------------|----------|
| 4 | PDSV02-10.16 | 15.2 | 100 |
| 6 | PDSV03-10.16 | 25.4 | 50 |
| 8 | PDSV04-10.16 | 35.6 | 50 |
| 10 | PDSV05-10.16 | 45.7 | 50 |
| 12 | PDSV06-10.16 | 55.9 | 20 |
| 14 | PDSV07-10.16 | 66.0 | 20 |
| 16 | PDSV08-10.16 | 76.2 | 20 |
| 18 | PDSV09-10.16 | 86.4 | 20 |
| 20 | PDSV10-10.16 | 96.5 | 10 |
| 22 | PDSV11-10.16 | 106.7 | 10 |
| 24 | PDSV12-10.16 | 116.8 | 10 |



Dimensions

| | | | |
|---|----------|---|----------|
| A | 12.20 mm | I | – |
| B | 15.20 mm | J | – |
| C | 23.74 mm | K | – |
| D | 3.90 mm | L | 1.00 mm |
| E | 15.24 mm | M | 1.00 mm |
| F | 4.00 mm | N | 15.50 mm |
| G | 22.00 mm | O | – |
| H | 22.80 mm | P | 10.16 mm |

Pluggable PCB Blocks

Pin Spacing: 10.16mm
 Orientation: Horizontal-Double
 Level Header
 Clamp Type: –
 Design: Modular - Open End



PDSH-10.16

ELECTRICAL

| | Current | Voltage | Wire Range |
|--|---------|---------|------------|
| | 12A | 300V | – |
| | 16A | 750V | – |

INSTALLATION DATA

| | | | |
|------------|---|-----------------|-------|
| Screw Size | – | PCB Hole Size | 1.5mm |
| Torque | – | Stripping Lgth. | – |

MATERIAL

| | | | |
|--------------------|-----------------------|----------|------------------|
| Body | PA6.8 | Screw | – |
| Flammability Class | UL94V-0 | Terminal | Tin-Plated Brass |
| Temperature Limit | 105°C UL 125°C IEC | Clamp | – |
| Color | Green | | |

| No. Poles | Cat. # | Length (B) (mm) | Std. Pk. |
|-----------|--------------|-----------------|----------|
| 4 | PDSH02-10.16 | 15.2 | 100 |
| 6 | PDSH03-10.16 | 25.4 | 50 |
| 8 | PDSH04-10.16 | 35.6 | 50 |
| 10 | PDSH05-10.16 | 45.7 | 50 |
| 12 | PDSH06-10.16 | 55.9 | 20 |
| 14 | PDSH07-10.16 | 66.0 | 20 |
| 16 | PDSH08-10.16 | 76.2 | 20 |
| 18 | PDSH09-10.16 | 86.4 | 20 |
| 20 | PDSH10-10.16 | 96.5 | 10 |
| 22 | PDSH11-10.16 | 106.7 | 10 |
| 24 | PDSH12-10.16 | 116.8 | 10 |

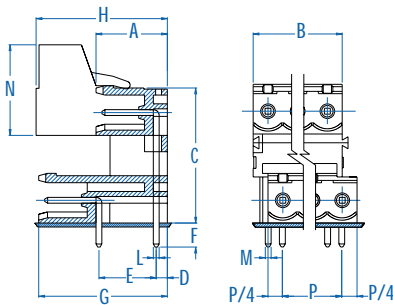

Dimensions

| | | | |
|---|----------|---|----------|
| A | 12.20 mm | I | – |
| B | 15.20 mm | J | – |
| C | 23.74 mm | K | – |
| D | 1.90 mm | L | 1.00 mm |
| E | 10.00 mm | M | 1.00 mm |
| F | 4.00 mm | N | 15.50 mm |
| G | 22.00 mm | O | – |
| H | 22.80 mm | P | 10.16 mm |

Barrier Strips

Pin Spacing: 10.00mm
 Orientation: Vertical
 Clamp Type: Screw
 Design: Modular

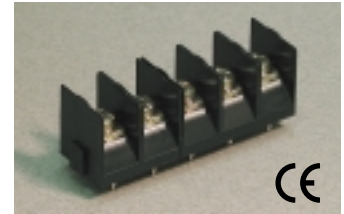

MT-210*

ELECTRICAL

| | Current | Voltage | Wire Range |
|--|---------|---------|---|
| | 20A | 300V | 26-12AWG |
| | 25A | 750V | 2x2.5mm ² Stranded 4.0mm ² Solid |

INSTALLATION DATA

| | | | |
|------------|------------------------|-----------------|--------|
| Screw Size | M3.5 | PCB Hole Size | 1.4mm |
| Torque | 0.8Nm (7.2 lbf-in.) | Stripping Lgth. | 11.0mm |

MATERIAL

| | | | |
|--------------------|-----------------------|----------|------------------|
| Body | PA6.8 | Screw | Galvanized Steel |
| Flammability Class | UL94V-0 | Terminal | Tin-Plated Brass |
| Temperature Limit | 105°C UL 125°C IEC | Washer | Iron |
| Color | Black | | |

| No. Poles | Cat. # | Length (B) (mm) | Std. Pk. |
|-----------|---------|-----------------|----------|
| 2 | MT-2102 | 20.0 | 100 |
| 3 | MT-2103 | 30.0 | 100 |
| 4 | MT-2104 | 40.0 | 50 |
| 5 | MT-2105 | 50.0 | 50 |
| 6 | MT-2106 | 60.0 | 50 |
| 7 | MT-2107 | 70.0 | 50 |
| 8 | MT-2108 | 80.0 | 50 |
| 9 | MT-2109 | 90.0 | 50 |
| 10 | MT-2110 | 100.0 | 50 |
| 11 | MT-2111 | 110.0 | 50 |
| 12 | MT-2112 | 120.0 | 50 |
| 13 | MT-2113 | 130.0 | 20 |
| 14 | MT-2114 | 140.0 | 20 |
| 15 | MT-2115 | 150.0 | 20 |
| 16 | MT-2116 | 160.0 | 20 |
| 17 | MT-2117 | 170.0 | 20 |
| 18 | MT-2118 | 180.0 | 20 |
| 19 | MT-2119 | 190.0 | 20 |
| 20 | MT-2120 | 200.0 | 20 |
| 21 | MT-2121 | 210.0 | 20 |
| 22 | MT-2122 | 220.0 | 20 |
| 23 | MT-2123 | 230.0 | 20 |
| 24 | MT-2124 | 240.0 | 20 |

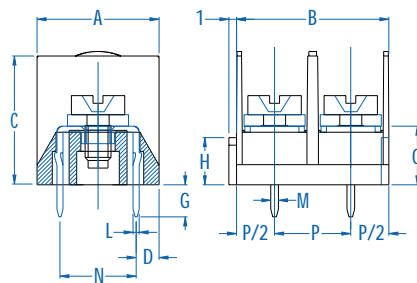

Dimensions

| | | | |
|---|----------|---|----------|
| A | 16.00 mm | I | – |
| B | 20.00 mm | J | – |
| C | 17.50 mm | K | – |
| D | 3.00 mm | L | 0.80 mm |
| E | – | M | 1.00 mm |
| F | – | N | 10.00 mm |
| G | 4.20 mm | O | 7.75 mm |
| H | 6.20 mm | P | 10.00 mm |

* Also available with back wall.

Panel Feed-through Blocks



Pin Spacing: 7.50mm
 Orientation: Panel Mount
 Clamp Type: Screw Cage
 Design: Modular



MPT-275/ CMR-75

ELECTRICAL

| | Current | Voltage | Wire Range |
|--|------------------|---------|---|
| | 15A ^① | 300V | 30-14AWG |
| | 24A | 450V | 2.5mm ² Stranded 4.0mm ² Solid |

INSTALLATION DATA

| | | | |
|-------------------|------------------------|------------------------|--------|
| Screw Size | M3 | Panel Hole Size | 5.2mm |
| Torque | 0.5Nm (4.5 lbf-in.) | Stripping Lgth. | 10.1mm |

MATERIAL

| | | | |
|---------------------------|-----------|-----------------|------------------|
| Body | PA6.8 | Screw | Galvanized Steel |
| Flammability Class | UL94V-0 | Terminal | Tin-Plated Brass |
| Temperature Limit | 125°C IEC | Clamp | Nickeled Brass |
| Color | Green | | |

| No. Poles | Cat. # | Length (B) (mm) | Std. Pk. |
|-----------|---------|-----------------|----------|
| 1 | MPT-275 | 7.5 | 100 |

Retaining Key

| | | | |
|---|---------|------|----|
| 2 | CMR-752 | 14.8 | 50 |
| 3 | CMR-753 | 22.3 | 50 |



Wall Thickness <4.0 mm

Dimensions

| | | | |
|---|----------|---|----------|
| A | 18.10 mm | I | 2.80 mm |
| B | 7.50 mm | J | 2.70 mm |
| C | 19.85 mm | K | Ø4.10 mm |
| D | 5.60 mm | L | 11.20 mm |
| E | 14.90 mm | M | 0.80 mm |
| F | - | N | 8.00 mm |
| G | Ø5.00 mm | O | 4.90 mm |
| H | 10.10 mm | P | - |



Dimensions

| | | | |
|---|----------|---|---------|
| A | 25.20 mm | I | - |
| B | 14.80 mm | J | - |
| C | 6.80 mm | K | - |
| D | 0.80 mm | L | 3.30 mm |
| E | - | M | 1.40 mm |
| F | - | N | - |
| G | - | O | - |
| H | 2.30 mm | P | 7.50 mm |

① 24A Factory Wiring - UL

Pin Spacing: 10.00mm
 Orientation: Panel Mount
 Clamp Type: Screw Cage
 Design: Modular



MPT-410/ CMR-10

ELECTRICAL

| | Current | Voltage | Wire Range |
|--|------------------|---------|---|
| | 20A ^② | 600V | 30-12AWG |
| | 32A | 450V | 4.0mm ² Stranded 6.0mm ² Solid |

INSTALLATION DATA

| | | | |
|-------------------|------------------------|------------------------|--------|
| Screw Size | M3 | Panel Hole Size | 8.2mm |
| Torque | 0.5Nm (4.5 lbf-in.) | Stripping Lgth. | 10.1mm |

MATERIAL

| | | | |
|---------------------------|-----------|-----------------|------------------|
| Body | PA6.8 | Screw | Galvanized Steel |
| Flammability Class | UL94V-0 | Terminal | Tin-Plated Brass |
| Temperature Limit | 125°C IEC | Clamp | Nickeled Brass |
| Color | Green | | |

| No. Poles | Cat. # | Length (B) (mm) | Std. Pk. |
|-----------|---------|-----------------|----------|
| 1 | MPT-410 | 10.0 | 100 |

Retaining Key

| | | | |
|---|---------|------|----|
| 2 | CMR-102 | 19.8 | 50 |
| 3 | CMR-103 | 29.3 | 50 |



Wall Thickness <4.0 mm

Dimensions

| | | | |
|---|----------|---|----------|
| A | 20.90 mm | I | 3.10 mm |
| B | 10.00 mm | J | 3.90 mm |
| C | 19.85 mm | K | Ø5.00 mm |
| D | 5.15 mm | L | 11.20 mm |
| E | 16.90 mm | M | 0.80 mm |
| F | - | N | 8.00 mm |
| G | Ø8.00 mm | O | 4.75 mm |
| H | 12.20 mm | P | - |



Dimensions

| | | | |
|---|----------|---|----------|
| A | 25.20 mm | I | - |
| B | 19.80 mm | J | - |
| C | 6.80 mm | K | - |
| D | 0.80 mm | L | 3.80 mm |
| E | - | M | 1.65 mm |
| F | - | N | - |
| G | - | O | - |
| H | 2.30 mm | P | 10.00 mm |

② 32A Factory Wiring - UL

INDEX

| PART # | PAGE | PART # | PAGE |
|------------------------|------|----------------------|------|
| CMR-10 | 49 | MVEB-25 | 24 |
| CMR-75 | 49 | MVI | 39 |
| MBE-15 | 7 | MVS-15 | 8 |
| MBES-15 | 12 | MVSP-25 | 14 |
| MH-15 | 10 | MVSP-27 | 22 |
| MH-25 | 14 | MVT-25 | 17 |
| MH-27 | 19 | MVTB-25 | 27 |
| MHB-25 | 25 | PDSH-10.16 | 48 |
| MHE-13 | 9 | PDSH-5.08 | 37 |
| MHE-16 | 10 | PDSV-5.08 | 37 |
| MHE-25 | 11 | PDSV-10.16 | 47 |
| MHE-27 | 20 | PH-10.00 | 44 |
| MHEB-25 | 24 | PH-10.16 | 46 |
| MHR-25 | 11 | PH-5.00 | 32 |
| MHR-27 | 20 | PH-5.08 | 36 |
| MHSP-25 | 15 | PH-5.08-K | 39 |
| MHSP-27 | 22 | PH-7.50 | 41 |
| MI-25 (35) | 15 | PHP-10.00 | 44 |
| MI-25 (45) | 16 | PHP-10.16 | 47 |
| MI-25 (5.00) | 12 | PHP-5.00 | 33 |
| MI-27 | 21 | PHP-5.08 | 36 |
| MPT-275 | 49 | PHP-7.50 | 42 |
| MPT-410 | 49 | PV-10.00 | 43 |
| MT-210 | 48 | PV-10.16 | 45 |
| MV-15 | 8 | PV-5.00 | 31 |
| MV-25 | 13 | PV-5.08 | 35 |
| MV-25-D | 13 | PV-5.08-K | 38 |
| MV-27 | 18 | PV-7.50 | 40 |
| MV-46 | 18 | PVP-10.00 | 43 |
| MV-47 | 21 | PVP-10.16 | 46 |
| MV-49 | 23 | PVP-5.00 | 32 |
| MVB-25 | 25 | PVP-5.08 | 35 |
| MVB-25-D | 26 | PVP-7.50 | 41 |
| MVD-25 | 16 | PVS-5.00 | 30 |
| MVDB-25 | 27 | SH-10.00 | 42 |
| MVDK-25 | 17 | SH-10.16 | 45 |
| MVDKB-25 | 26 | SH-5.00 | 31 |
| MVE-15 | 7 | SH-5.08 | 33 |
| MVE-25 | 9 | SH-5.08-K | 38 |
| MVE-27 | 19 | SH-7.50 | 40 |
| MVE-35 | 6 | SHS-5.00 | 30 |
| MVE-38 | 6 | SVF-5.08 | 34 |
| MVEB-15 | 23 | SVP-5.08 | 34 |

COMMONLY USED METRIC AND OTHER USEFUL CONVERSIONS

| Length inch [in.] millimeters [mm] meters [m] miles [mi] kilometers [km] | x 25.4 x 0.03937 x 3.281 x 1.609 x 0.6214 | =millimeters =inches =feet =kilometers =miles | Metric Cross-Sectional Areas a | | | American Wire Gauge | | |
|---|---|---|--------------------------------------|--|----------------------|--------------------------------------|--|------------------------------|
| | | | Cross-Sectional Area mm ² | Equivalent Metric Area mm ² | AWG or MCM | Cross-Sectional Area mm ² | Equivalent Metric Area mm ² | AWG or MCM |
| Torque Newtonmeter [Nm] lb-ft lb-in oz-in | x 0.738 x 1.356 x 0.113 x 0.0071 | =lb-ft =Nm =Nm =Nm | 0.50 0.75 | 0.519 0.653 0.823 | 20 AWG 19 18 | 25.0 35.0 | 21.15 26.67 33.63 | 4 AWG 3 2 |
| Power kilowatt [kW] hp | x 1.341 x 0.7457 | =hp =kW | 1.5 | 1.04 1.31 | 17 16 | 50.0 | 42.41 | 1 |
| Moment of Inertia (WR2) lb-ft ² kilogrammeter ² [kgm ²] | x 0.042 23.720 | =kgm ² =lb-ft ² | 2.5 | 1.65 2.08 | 15 14 | 70.0 95.0 | 53.48 67.43 | 1/0 2/0 |
| Weight Mass and Force Newton [N] kilogram [kg] pound [lb] pound [lb] | x 0.02248 x 2.205 x 4.448 x 0.4536 | =pound =pounds =N =kg | 4.0 | 2.62 3.31 4.17 5.26 | 13 12 11 10 | 120.0 150.0 185.0 | 107.20 126.64 152.00 177.35 | 4/0 250 MCM 300 350 |
| | | | 6.0 | 6.63 8.37 | 9 8 | 240.0 300.0 400.0 | 202.71 253.35 380.00 | 400 500 750 |
| | | | 10.0 | 10.55 13.30 | 7 6 | 500.0 625.0 | 506.71 | 1000 |
| | | | 16.0 | 16.77 | 5 | | | |

^aAs per IEC Publ. 228

| DEGREES CELSIUS VERSUS DEGREES FAHRENHEIT | | | | | | | | | | | | | | | |
|---|--------|-----|------|----|------|----|-------|----|-------|-----|-------|-----|-------|------|-------|
| °C | °F | °C | °F | °C | °F | °C | °F | °C | °F | °C | °F | °C | °F | °C | °F |
| -80 | -112.0 | -20 | -4.0 | 5 | 41.0 | 30 | 86.0 | 55 | 131.0 | 80 | 176.0 | 105 | 221.0 | 130 | 266.0 |
| -70 | -94.0 | -19 | -2.2 | 6 | 42.8 | 31 | 87.8 | 56 | 132.8 | 81 | 177.8 | 106 | 222.8 | 131 | 267.8 |
| -60 | -65.0 | -18 | -0.4 | 7 | 44.6 | 32 | 89.6 | 57 | 134.6 | 82 | 179.6 | 107 | 224.6 | 132 | 269.6 |
| -50 | -58.0 | -17 | +1.4 | 8 | 46.4 | 33 | 91.4 | 58 | 136.4 | 83 | 181.4 | 108 | 226.4 | 133 | 271.4 |
| -45 | -49.1 | -16 | 3.2 | 9 | 48.2 | 34 | 93.2 | 59 | 138.2 | 84 | 183.2 | 109 | 228.2 | 134 | 273.2 |
| -40 | -40.0 | -15 | 5.0 | 10 | 50.0 | 35 | 95.0 | 60 | 140.0 | 85 | 185.0 | 110 | 230.0 | 135 | 275.0 |
| -39 | -38.2 | -14 | 6.8 | 11 | 51.8 | 36 | 96.8 | 61 | 141.8 | 86 | 186.8 | 111 | 231.8 | 136 | 276.8 |
| -38 | -36.4 | -13 | 8.6 | 12 | 53.6 | 37 | 98.6 | 62 | 143.6 | 87 | 188.6 | 112 | 233.6 | 137 | 278.6 |
| -37 | -34.6 | -12 | 10.4 | 13 | 55.4 | 38 | 100.4 | 63 | 145.4 | 88 | 189.4 | 113 | 235.4 | 138 | 280.4 |
| -36 | -32.8 | -11 | 12.2 | 14 | 57.2 | 39 | 102.2 | 64 | 147.2 | 89 | 192.2 | 114 | 237.2 | 139 | 282.2 |
| -35 | -31.0 | -10 | 14.0 | 15 | 59.0 | 40 | 104.0 | 65 | 149.0 | 90 | 194.0 | 115 | 239.0 | 140 | 284.0 |
| -34 | -29.2 | -9 | 15.8 | 16 | 60.8 | 41 | 105.8 | 66 | 150.8 | 91 | 195.8 | 116 | 240.8 | 141 | 285.8 |
| -33 | -27.4 | -8 | 17.6 | 17 | 62.6 | 42 | 107.6 | 67 | 152.6 | 92 | 197.6 | 117 | 242.6 | 142 | 287.6 |
| -32 | -25.6 | -7 | 19.4 | 18 | 64.4 | 43 | 109.4 | 68 | 154.4 | 93 | 199.4 | 118 | 244.4 | 143 | 289.4 |
| -31 | -23.8 | -6 | 21.2 | 19 | 66.2 | 44 | 111.2 | 69 | 156.2 | 94 | 201.2 | 119 | 246.2 | 144 | 291.2 |
| -30 | -22.0 | -5 | 23.0 | 20 | 68.0 | 45 | 113.0 | 70 | 158.0 | 95 | 203.0 | 120 | 248.0 | 145 | 293.0 |
| -29 | -22.0 | -4 | 24.8 | 21 | 69.8 | 46 | 114.8 | 71 | 159.8 | 96 | 204.8 | 121 | 249.8 | 146 | 294.8 |
| -28 | -18.4 | -3 | 26.6 | 22 | 71.6 | 47 | 116.6 | 72 | 161.6 | 97 | 206.6 | 122 | 251.6 | 147 | 296.6 |
| -27 | -16.6 | -2 | 28.4 | 23 | 73.4 | 48 | 118.4 | 73 | 163.4 | 98 | 208.4 | 123 | 253.4 | 148 | 298.4 |
| -26 | -14.8 | -1 | 30.2 | 24 | 75.2 | 49 | 120.2 | 74 | 165.2 | 99 | 210.2 | 124 | 255.2 | 149 | 300.2 |
| -25 | -13.0 | 0 | 32.0 | 25 | 77.0 | 50 | 122.0 | 75 | 167.0 | 100 | 212.0 | 125 | 257.0 | 150 | 302.0 |
| -24 | -11.2 | 1 | 33.8 | 26 | 78.8 | 51 | 123.8 | 76 | 168.8 | 101 | 213.8 | 126 | 258.8 | 160 | 320.0 |
| -23 | -9.4 | 2 | 35.6 | 27 | 80.6 | 52 | 125.6 | 77 | 170.6 | 102 | 215.6 | 127 | 260.6 | 170 | 338.0 |
| -22 | -7.6 | 3 | 37.4 | 28 | 82.4 | 53 | 127.4 | 78 | 172.4 | 103 | 217.4 | 128 | 262.4 | 180 | 356.0 |
| -21 | -5.8 | 4 | 39.2 | 29 | 84.2 | 54 | 129.2 | 79 | 174.2 | 104 | 219.2 | 129 | 264.2 | 190 | 374.0 |
| | | | | | | | | | | | | | | 2000 | 3632 |

Conversion Formula °F = 9/5°C + 32° °C = 5/9(°F-32°)

Компания «Океан Электроники» предлагает заключение долгосрочных отношений при поставках импортных электронных компонентов на взаимовыгодных условиях!

Наши преимущества:

- Поставка оригинальных импортных электронных компонентов напрямую с производств Америки, Европы и Азии, а так же с крупнейших складов мира;
- Широкая линейка поставок активных и пассивных импортных электронных компонентов (более 30 млн. наименований);
- Поставка сложных, дефицитных, либо снятых с производства позиций;
- Оперативные сроки поставки под заказ (от 5 рабочих дней);
- Экспресс доставка в любую точку России;
- Помощь Конструкторского Отдела и консультации квалифицированных инженеров;
- Техническая поддержка проекта, помощь в подборе аналогов, поставка прототипов;
- Поставка электронных компонентов под контролем ВП;
- Система менеджмента качества сертифицирована по Международному стандарту ISO 9001;
- При необходимости вся продукция военного и аэрокосмического назначения проходит испытания и сертификацию в лаборатории (по согласованию с заказчиком);
- Поставка специализированных компонентов военного и аэрокосмического уровня качества (Xilinx, Altera, Analog Devices, Intersil, Interpoint, Microsemi, Actel, Aeroflex, Peregrine, VPT, Syfer, Eurofarad, Texas Instruments, MS Kennedy, Miteq, Cobham, E2V, MA-COM, Hittite, Mini-Circuits, General Dynamics и др.);

Компания «Океан Электроники» является официальным дистрибьютором и эксклюзивным представителем в России одного из крупнейших производителей разъемов военного и аэрокосмического назначения «JONHON», а так же официальным дистрибьютором и эксклюзивным представителем в России производителя высокотехнологичных и надежных решений для передачи СВЧ сигналов «FORSTAR».



JONHON

«JONHON» (основан в 1970 г.)

Разъемы специального, военного и аэрокосмического назначения:

(Применяются в военной, авиационной, аэрокосмической, морской, железнодорожной, горно- и нефтедобывающей отраслях промышленности)

«FORSTAR» (основан в 1998 г.)

ВЧ соединители, коаксиальные кабели, кабельные сборки и микроволновые компоненты:

(Применяются в телекоммуникациях гражданского и специального назначения, в средствах связи, РЛС, а так же военной, авиационной и аэрокосмической отраслях промышленности).



Телефон: 8 (812) 309-75-97 (многоканальный)

Факс: 8 (812) 320-03-32

Электронная почта: ocean@oceanchips.ru

Web: <http://oceanchips.ru/>

Адрес: 198099, г. Санкт-Петербург, ул. Калинина, д. 2, корп. 4, лит. А